



Is Now Part of



**ON Semiconductor®**

To learn more about ON Semiconductor, please visit our website at  
[www.onsemi.com](http://www.onsemi.com)

Please note: As part of the Fairchild Semiconductor integration, some of the Fairchild orderable part numbers will need to change in order to meet ON Semiconductor's system requirements. Since the ON Semiconductor product management systems do not have the ability to manage part nomenclature that utilizes an underscore (\_), the underscore (\_) in the Fairchild part numbers will be changed to a dash (-). This document may contain device numbers with an underscore (\_). Please check the ON Semiconductor website to verify the updated device numbers. The most current and up-to-date ordering information can be found at [www.onsemi.com](http://www.onsemi.com). Please email any questions regarding the system integration to [Fairchild\\_questions@onsemi.com](mailto:Fairchild_questions@onsemi.com).

ON Semiconductor and the ON Semiconductor logo are trademarks of Semiconductor Components Industries, LLC dba ON Semiconductor or its subsidiaries in the United States and/or other countries. ON Semiconductor owns the rights to a number of patents, trademarks, copyrights, trade secrets, and other intellectual property. A listing of ON Semiconductor's product/patent coverage may be accessed at [www.onsemi.com/site/pdf/Patent-Marking.pdf](http://www.onsemi.com/site/pdf/Patent-Marking.pdf). ON Semiconductor reserves the right to make changes without further notice to any products herein. ON Semiconductor makes no warranty, representation or guarantee regarding the suitability of its products for any particular purpose, nor does ON Semiconductor assume any liability arising out of the application or use of any product or circuit, and specifically disclaims any and all liability, including without limitation special, consequential or incidental damages. Buyer is responsible for its products and applications using ON Semiconductor products, including compliance with all laws, regulations and safety requirements or standards, regardless of any support or applications information provided by ON Semiconductor. "Typical" parameters which may be provided in ON Semiconductor data sheets and/or specifications can and do vary in different applications and actual performance may vary over time. All operating parameters, including "Typicals" must be validated for each customer application by customer's technical experts. ON Semiconductor does not convey any license under its patent rights nor the rights of others. ON Semiconductor products are not designed, intended, or authorized for use as a critical component in life support systems or any FDA Class 3 medical devices or medical devices with a same or similar classification in a foreign jurisdiction or any devices intended for implantation in the human body. Should Buyer purchase or use ON Semiconductor products for any such unintended or unauthorized application, Buyer shall indemnify and hold ON Semiconductor and its officers, employees, subsidiaries, affiliates, and distributors harmless against all claims, costs, damages, and expenses, and reasonable attorney fees arising out of, directly or indirectly, any claim of personal injury or death associated with such unintended or unauthorized use, even if such claim alleges that ON Semiconductor was negligent regarding the design or manufacture of the part. ON Semiconductor is an Equal Opportunity/Affirmative Action Employer. This literature is subject to all applicable copyright laws and is not for resale in any manner.

## FPF1107 / FPF1108 Advance Load Management Switch

### Features

- 1.2V to 4V Input Voltage Operating Range
- Typical  $R_{DS(ON)}$ :
  - 35m $\Omega$  at  $V_{IN}=3.3V$
  - 55m $\Omega$  at  $V_{IN}=1.8V$
  - 85m $\Omega$  at  $V_{IN}=1.2V$
- Slew Rate Control with  $t_R$ : 130 $\mu s$
- Output Discharge Function on FPF1108
- Low <1 $\mu A$  Quiescent Current at  $V_{ON}=V_{IN}$
- ESD Protected: Above 4000V HBM, 2000V CDM
- GPIO/CMOS-Compatible Enable Circuitry

### Applications

- Mobile Devices and Smart Phones
- Portable Media Devices
- Digital Cameras
- Advanced Notebook, UMPC, MID
- Portable Medical Devices
- GPS and Navigation Equipment

### Description

The FPF1107/08 are low  $R_{DS}$  P-channel MOSFET load switches of the IntelliMAX™ family. Integrated slew-rate control prevents inrush current from glitch supply rails with capacitive loads common in power applications.

The input voltage range operates from 1.2V to 4V to fulfill today's lowest ultra-portable device supply requirements. Switch control is by a logic input (ON-pin) capable of interfacing directly with low-voltage CMOS control signals and GPIOs in embedded processors.

### Ordering Information

Part Number	Part Marking	Switch (Typical) At 1.8V <sub>IN</sub>	Input Buffer	Output Discharge	ON Pin Activity	t <sub>R</sub>	Eco Status	Package
FPF1107	QC	55m $\Omega$	CMOS	NA	Active HIGH	130 $\mu s$	Green	4-Ball, Wafer-Level Chip-Scale Package (WLCSP), 1.0 x 1.0mm, 0.5mm Pitch
FPF1108	QD	55m $\Omega$	CMOS	65 $\Omega$	Active HIGH	130 $\mu s$	Green	

 For Fairchild's definition of Eco Status, please visit: [http://www.fairchildsemi.com/company/green/rohs\\_green.html](http://www.fairchildsemi.com/company/green/rohs_green.html).

### Application Diagram

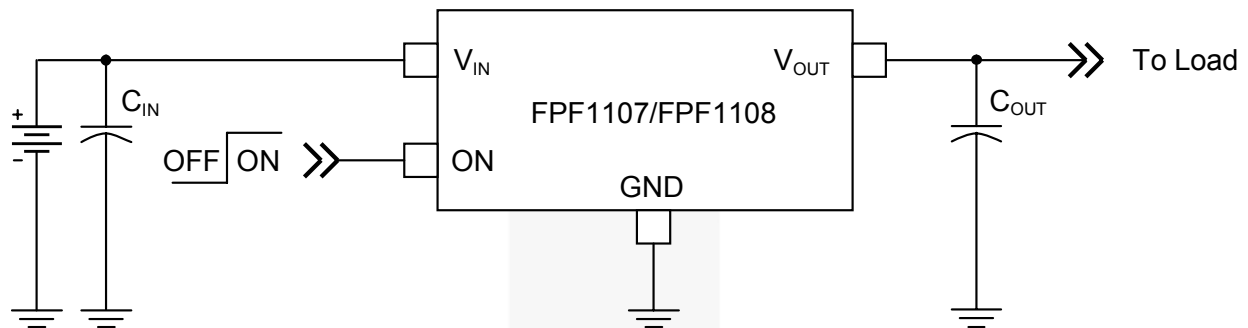


Figure 1. Typical Application

**Notes:**

1.  $C_{IN}=1\mu\text{F}$ , X5R, 0603, for example Murata GRM185R60J105KE26
2.  $C_{OUT}=1\mu\text{F}$ , X5R, 0805, for example Murata GRM216R61A105KA01

### Block Diagram

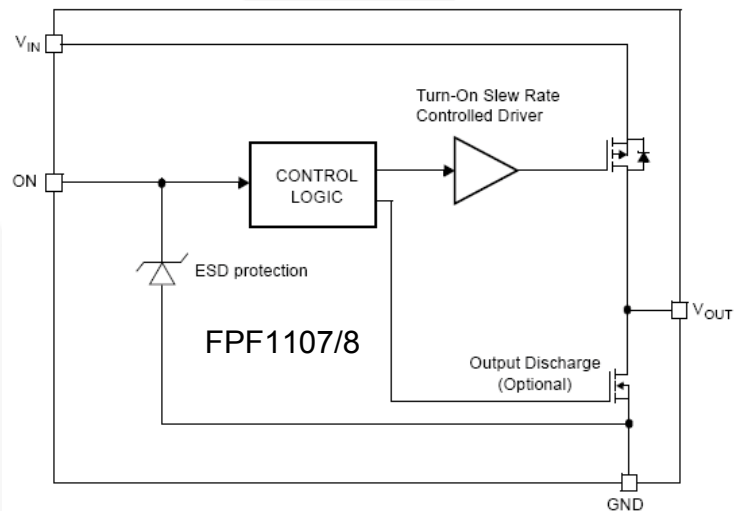


Figure 2. Block Diagram (Output Discharge for FPF1108 Only)

## Pin Configurations

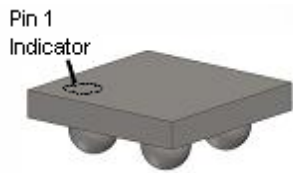


Figure 3. 1 x 1mm WLCSP Bumps Facing Down

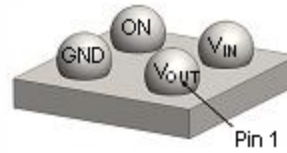


Figure 4. 1 x 1mm WLCSP Bumps Facing Up

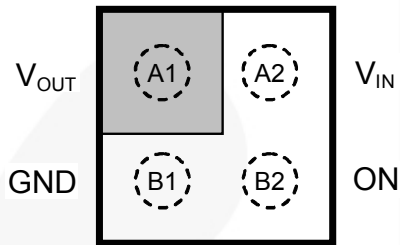


Figure 5. Pin Assignments (Top View)

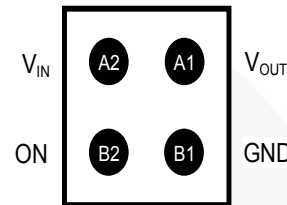


Figure 6. Pin Assignments (Bottom View)

## Pin Definitions

Pin #	Name	Description
A1	$V_{OUT}$	Switch Output
A2	$V_{IN}$	Supply Input: Input to the Power Switch.
B1	GND	Ground
B2	ON	ON/OFF Control, Active HIGH

## Absolute Maximum Ratings

Stresses exceeding the absolute maximum ratings may damage the device. The device may not function or be operable above the recommended operating conditions and stressing the parts to these levels is not recommended. In addition, extended exposure to stresses above the recommended operating conditions may affect device reliability. The absolute maximum ratings are stress ratings only.

Symbol	Parameter	Min.	Max.	Unit	
$V_{IN}$	$V_{IN}$ , $V_{OUT}$ , $V_{ON}$ to GND	-0.3	4.2	V	
$I_{SW}$	Maximum Continuous Switch Current		1.2	A	
$P_D$	Power Dissipation at $T_A=25^\circ\text{C}$		1.0	W	
$T_{STG}$	Storage Junction Temperature	-65	+150	$^\circ\text{C}$	
$T_A$	Operating Temperature Range	-40	+85	$^\circ\text{C}$	
$\Theta_{JA}$	Thermal Resistance, Junction-to-Ambient	1S2P with 1 Thermal Via		95	$^\circ\text{C/W}$
		1S2P without Thermal Via		187	
ESD	Electrostatic Discharge Capability	Human Body Model, JESD22-A114	4		kV
		Charged Device Model, JESD22-C101	2		

## Recommended Operating Conditions

The Recommended Operating Conditions table defines the conditions for actual device operation. Recommended operating conditions are specified to ensure optimal performance to the datasheet specifications. Fairchild does not recommend exceeding them or designing to Absolute Maximum Ratings.

Symbol	Parameter	Min.	Max.	Unit
$V_{IN}$	Supply Voltage	1.2	4.0	V
$T_A$	Ambient Operating Temperature	-40	+85	$^\circ\text{C}$

## Electrical Characteristics

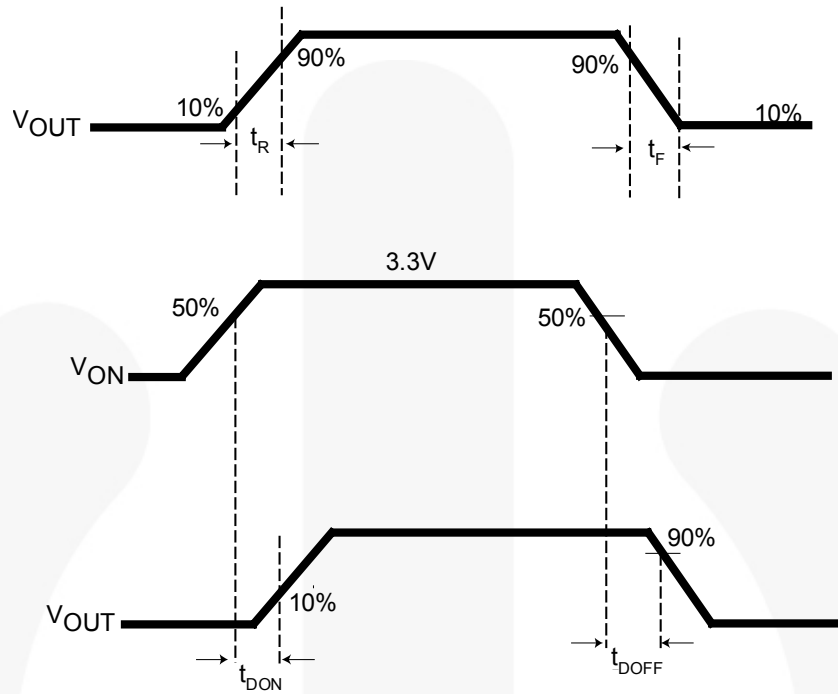
Unless otherwise noted,  $V_{IN}=1.2$  to  $4.0V$ ,  $T_A=-40$  to  $+85^\circ C$ , typical values are at  $V_{IN}=3.3V$  and  $T_A=25^\circ C$ .

Symbol	Parameter	Conditions	Min.	Typ.	Max.	Units
<b>Basic Operation</b>						
$V_{IN}$	Supply Voltage		1.2		4.0	V
$I_{Q(OFF)}$	Off Supply Current	$V_{ON}=GND$ $V_{OUT}=Open$ , $V_{IN}=4V$			1	$\mu A$
$I_{SD(OFF)}$	Off Switch Current	$V_{ON}=GND$ $V_{OUT}=GND$			1	$\mu A$
$I_Q$	Quiescent Current	$I_{OUT}=0mA$ , $V_{ON}=V_{IN}$			1	$\mu A$
		$I_{OUT}=0mA$ , $V_{ON} < V_{IN}$			3	
$R_{ON}$	On Resistance	$V_{IN}=3.3V$ , $I_{OUT}=200mA$ , $T_A=25^\circ C$		35	50	m $\Omega$
		$V_{IN}=1.8V$ , $I_{OUT}=200mA$ , $T_A=25^\circ C$		55	70	
		$V_{IN}=1.5V$ , $I_{OUT}=200mA$ , $T_A=25^\circ C$		70		
		$V_{IN}=1.2V$ , $I_{OUT}=200mA$ , $T_A=25^\circ C$		85	150	
		$V_{IN}=1.8V$ , $I_{OUT}=200mA$ , $T_A=85^\circ C^{(3)}$		65	100	
$R_{PD}$	Output Discharge $R_{PULL\ DOWN}$	$V_{IN}=3.3V$ , $V_{ON}=0V$ , $I_{FORCE}=20mA$ , $T_A=25^\circ C$ , PPF1108		65	110	$\Omega$
$V_{IH}$	On Input Logic High Voltage	$V_{IN}=1.2V$ to $4.0V$	1.1			V
$V_{IL}$	On Input Logic Low Voltage	$V_{IN}=1.2V$ to $4.0V$			0.35	V
$I_{ON}$	On Input Leakage	$V_{ON}=V_{IN}$ or $GND$	-1		1	$\mu A$
<b>Dynamic Characteristics</b>						
$t_{DON}$	Turn-On Delay <sup>(4)</sup>	$V_{IN}=3.3V$ , $R_L=10\Omega$ , $C_L=0.1\mu F$ , $T_A=25^\circ C$ , PPF1107/8		80		$\mu s$
$t_R$	$V_{OUT}$ Rise Time <sup>(4)</sup>			130		$\mu s$
$t_{ON}$	Turn-On Time <sup>(4,6)</sup>			210		$\mu s$
$t_{DON}$	Turn-On Delay <sup>(4)</sup>	$V_{IN}=3.3V$ , $R_L=500\Omega$ , $C_L=0.1\mu F$ , $T_A=25^\circ C$ , PPF1107/8		70	95	$\mu s$
$t_R$	$V_{OUT}$ Rise Time <sup>(4)</sup>			95	120	$\mu s$
$t_{ON}$	Turn-On Time <sup>(4,6)</sup>			165	215	$\mu s$
<b>PPF1107</b>						
$t_{DOFF}$	Turn-Off Delay <sup>(4)</sup>	$V_{IN}=3.3V$ , $R_L=10\Omega$ , $C_L=0.1\mu F$ , $T_A=25^\circ C$		2.0	2.5	$\mu s$
$t_F$	$V_{OUT}$ Fall Time <sup>(4)</sup>			2.2		$\mu s$
$t_{OFF}$	Turn-Off <sup>(4,7)</sup>			4.2		$\mu s$
$t_{DOFF}$	Turn-Off Delay <sup>(4)</sup>	$V_{IN}=3.3V$ , $R_L=500\Omega$ , $C_L=0.1\mu F$ , $T_A=25^\circ C$		7.0		$\mu s$
$t_F$	$V_{OUT}$ Fall Time <sup>(4)</sup>			110		$\mu s$
$t_{OFF}$	Turn-Off <sup>(4,7)</sup>			117		$\mu s$
<b>PPF1108<sup>(5)</sup></b>						
$t_{DOFF}$	Turn-Off Delay <sup>(4)</sup>	$V_{IN}=3.3V$ , $R_L=10\Omega$ , $C_L=0.1\mu F$ , $R_{PD}=65\Omega$ , $T_A=25^\circ C$		2.0	2.5	$\mu s$
$t_F$	$V_{OUT}$ Fall Time <sup>(4)</sup>			1.9		$\mu s$
$t_{OFF}$	Turn-Off <sup>(4,7)</sup>			3.9		$\mu s$
$t_{DOFF}$	Turn-Off Delay <sup>(4)</sup>	$V_{IN}=3.3V$ , $R_L=500\Omega$ , $C_L=0.1\mu F$ , $R_{PD}=65\Omega$ , $T_A=25^\circ C$		2.5		$\mu s$
$t_F$	$V_{OUT}$ Fall Time <sup>(4)</sup>			10.6		$\mu s$
$t_{OFF}$	Turn-Off <sup>(4,7)</sup>			13.1		$\mu s$

### Notes:

- This parameter is guaranteed by design and characterization; not production tested.
- $t_{DON}/t_{DOFF}/t_R/t_F$  are defined in Figure 7.
- Output discharge path is enabled during off.

### Timing Diagram



**Notes:**

- 6.  $t_{ON} = t_R + t_{DON}$ .
- 7.  $t_{OFF} = t_F + t_{DOFF}$ .

Figure 7. Timing Diagram



## Typical Performance Characteristics

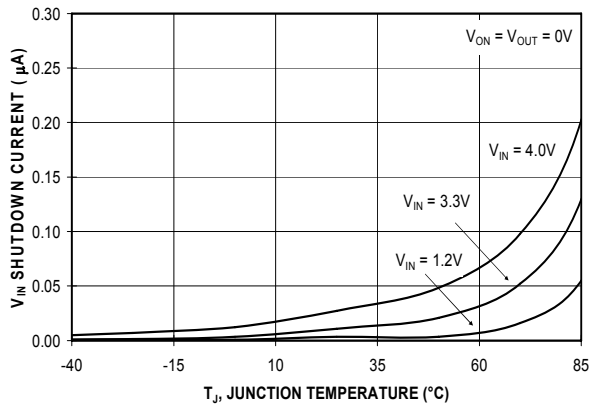


Figure 8. Shutdown Current vs. Temperature

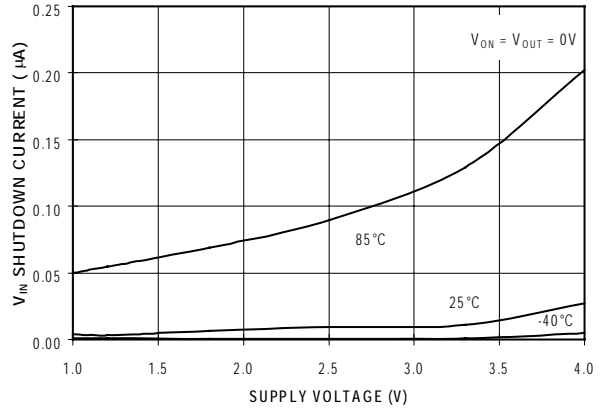


Figure 9. Shutdown Current vs. Supply Voltage

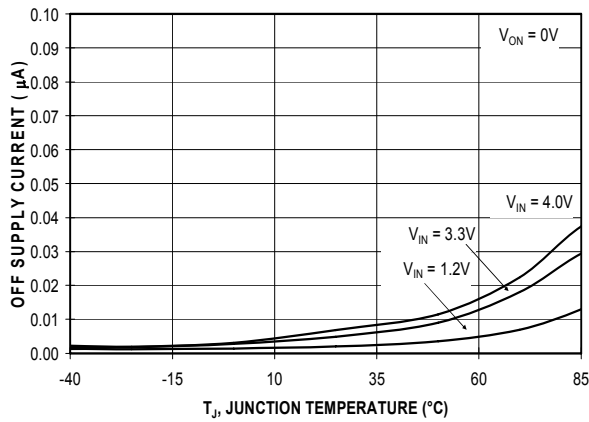


Figure 10. Off Supply Current vs. Temperature (FPF1107, VOUT is Floating)

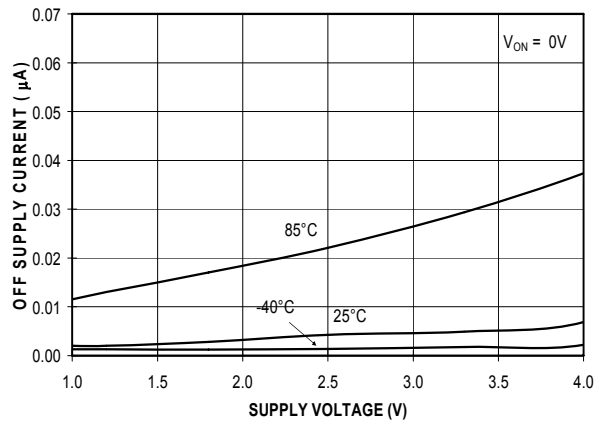


Figure 11. Off Supply Current vs. Supply Voltage (FPF1107, VOUT is Floating)

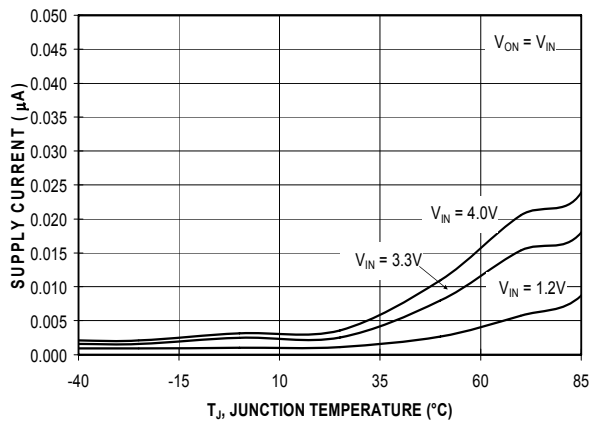


Figure 12. Quiescent Current vs. Temperature (V<sub>ON</sub>=V<sub>IN</sub>)

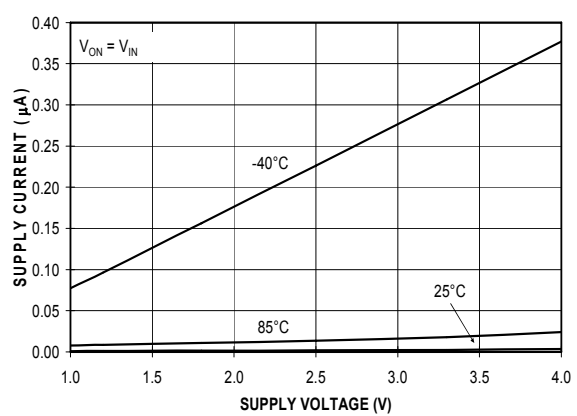


Figure 13. Quiescent Current vs. Supply Voltage



### Typical Performance Characteristics

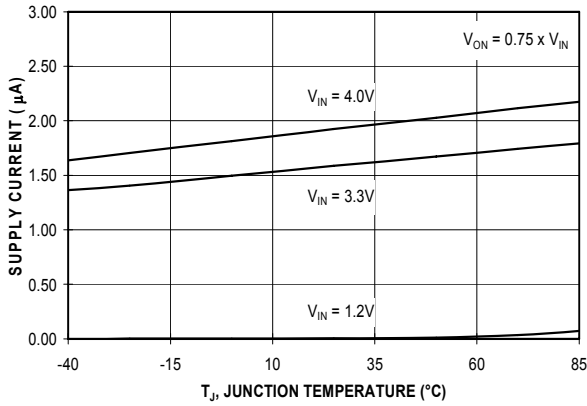


Figure 14. Quiescent Current vs. Temperature ( $V_{ON}=0.75 \times V_{IN}$ )

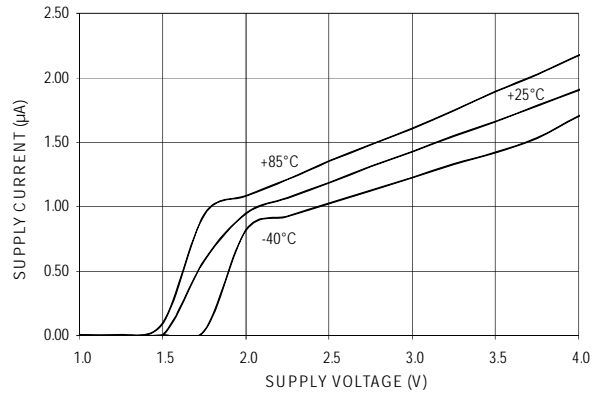


Figure 15. Quiescent Current vs. Supply Voltage at  $V_{ON}=1.2V$

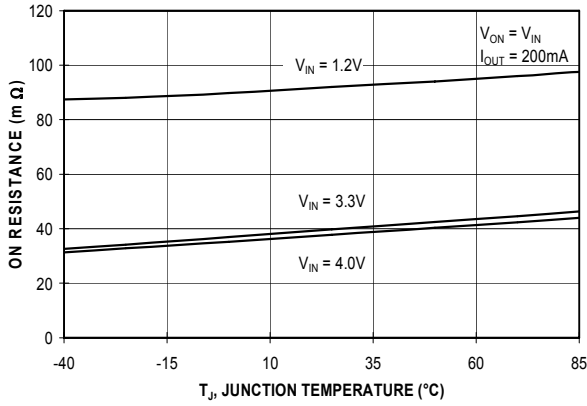


Figure 16.  $R_{ON}$  vs. Temperature

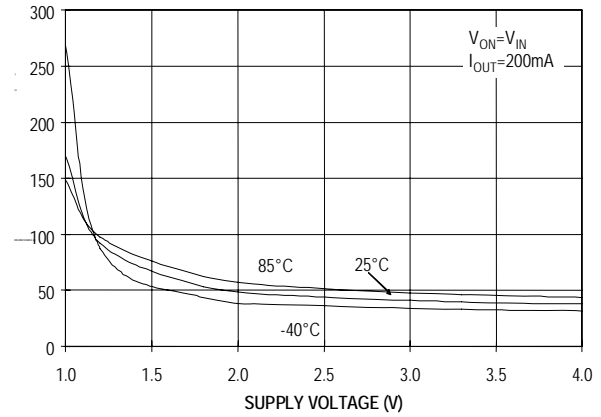


Figure 17.  $R_{ON}$  vs. Supply Voltage

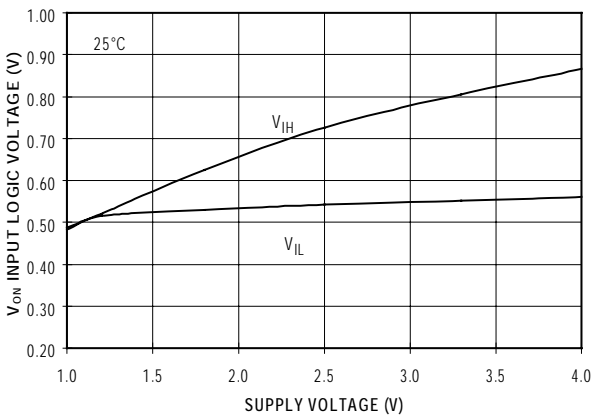
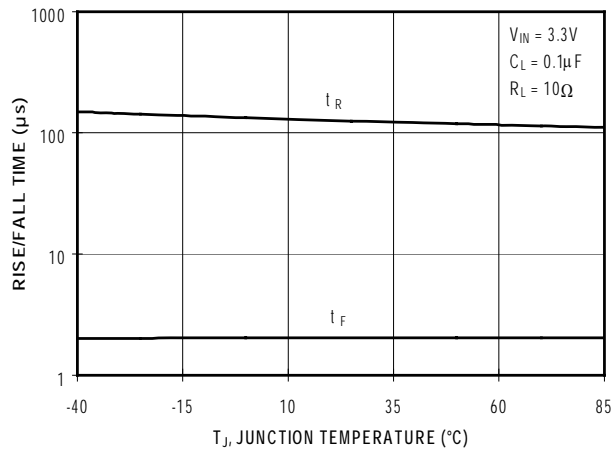
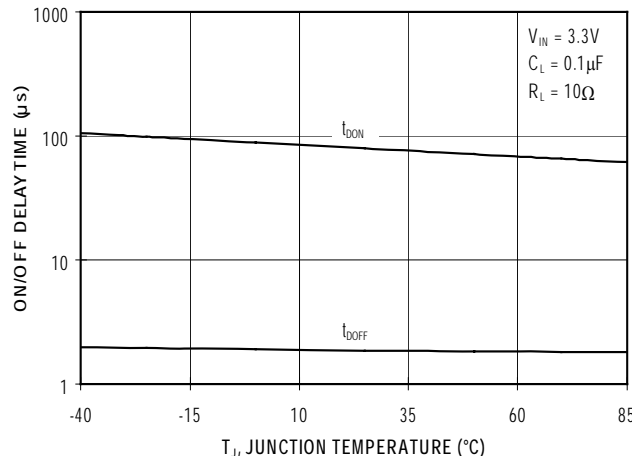


Figure 18. ON-Pin Threshold vs.  $V_{IN}$

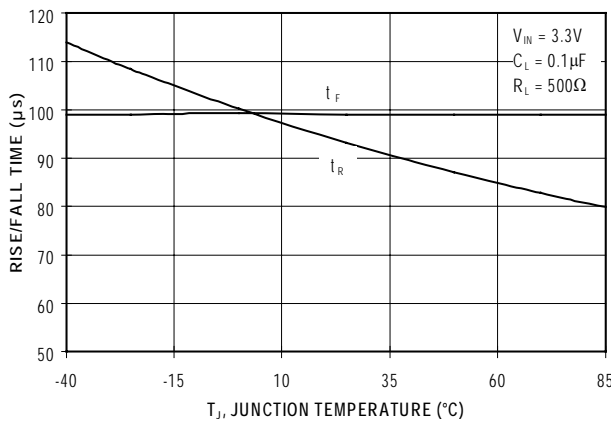
### Typical Performance Characteristics



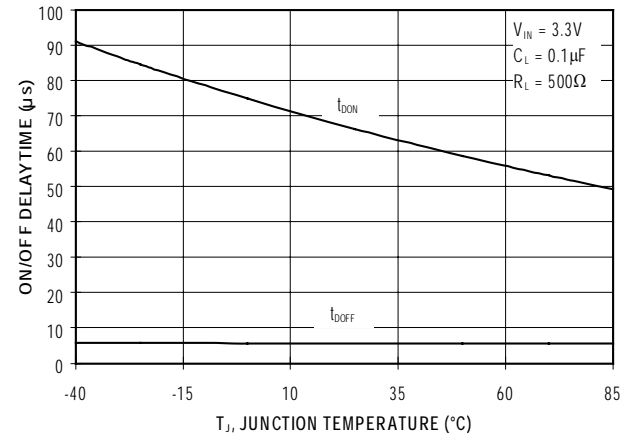
**Figure 19.  $V_{OUT}$  Rise and Fall Time vs. Temperature at  $R_L=10\Omega$**



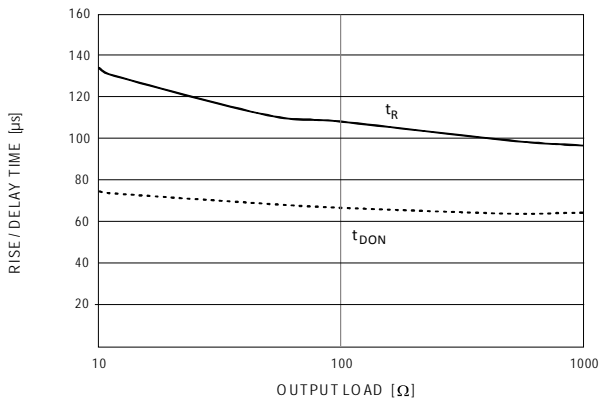
**Figure 20.  $V_{OUT}$  Turn-On and Turn-Off Delay vs. Temperature at  $R_L=10\Omega$**



**Figure 21.  $V_{OUT}$  Rise and Fall Time vs. Temperature at  $R_L=500\Omega$**

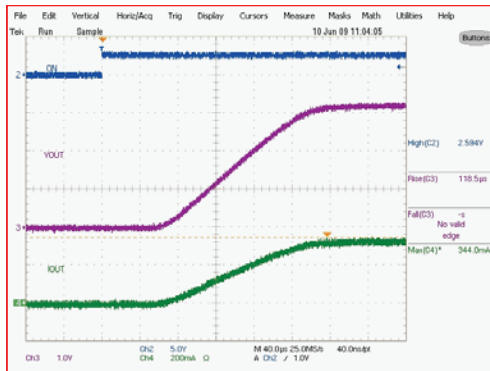


**Figure 22.  $V_{OUT}$  Turn-On and Turn-Off Delay vs. Temperature at  $R_L=500\Omega$**

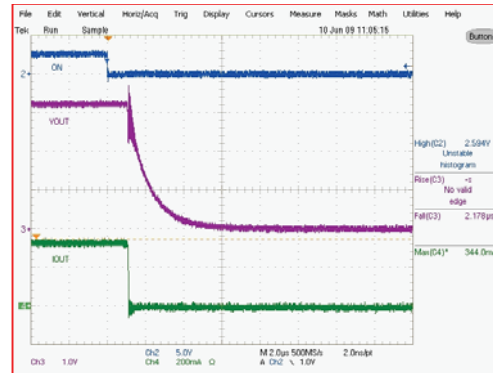


**Figure 23.  $V_{OUT}$  Turn-On and Turn-Off Delay vs. Output Load at  $V_{IN}=3.3V$**

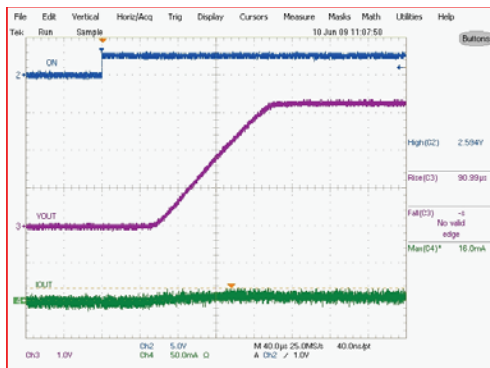
## Typical Performance Characteristics



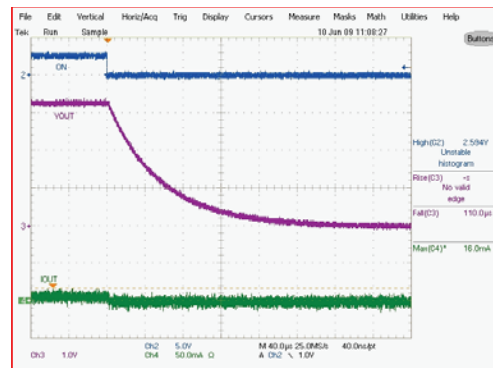
**Figure 24. Turn-On Response**  
 $(V_{IN}=3.3V, C_{IN}=1\mu F, C_{OUT}=0.1\mu F, R_L=10\Omega)$



**Figure 25. Turn-Off Response**  
 $(V_{IN}=3.3V, C_{IN}=1\mu F, C_{OUT}=0.1\mu F, R_L=10\Omega)$



**Figure 26. Turn-On Response**  
 $(V_{IN}=3.3V, C_{IN}=1\mu F, C_{OUT}=0.1\mu F, R_L=500\Omega)$



**Figure 27. Turn-Off Response**  
 (FPF1107 – No Output Pull-Down Resistor)  
 $(V_{IN}=3.3V, C_{IN}=1\mu F, C_{OUT}=0.1\mu F, R_L=500\Omega)$

## Application Information

### Input Capacitor

The IntelliMAX™ switch doesn't require input capacitor. To reduce device inrush current effect, a 0.1μF ceramic capacitor, C<sub>IN</sub>, is recommended close to the VIN pin. A higher value of C<sub>IN</sub> can be used to further reduce the voltage drop experienced as the switch is turned on into a large capacitive load.

### Output Capacitor

The IntelliMAX™ switch works without an output capacitor. However, if parasitic board inductance forces V<sub>OUT</sub> below GND when switching off, a 0.1μF capacitor, C<sub>OUT</sub>, should be placed between V<sub>OUT</sub> and GND.

### Fall Time

Device output fall time can be calculated based on RC constant of external components as follows:

$$t_F = R_L \times C_L \times 2.2 \quad (1)$$

where t<sub>F</sub> is 90% to 10% fall time, R<sub>L</sub> is output load and C<sub>L</sub> is output capacitor.

The same equation works for a device with a pull-down output resistor, then R<sub>L</sub> is replaced by a parallel connected pull-down and external output resistor combination, as follows:

$$t_F = \frac{R_L \times R_{PD}}{R_L + R_{PD}} \times C_L \times 2.2 \quad (2)$$

where t<sub>F</sub> is 90% to 10% fall time, R<sub>L</sub> is output load, R<sub>PD</sub>=65Ω is output pull-down resistor, and C<sub>L</sub> is the output capacitor.

### Resistive Output Load

If resistive output load is missing, the IntelliMAX™ switch without pull-down output resistor is not discharging output voltage. Output voltage drop depends, in that case, mainly on external device leaks.

### Recommended Land Pattern and Layout

For best thermal performance and minimal inductance and parasitic effects, it is recommended to keep input and output traces short and capacitors as close to the

device as possible. Below is a recommended layout for this device to achieve optimum performance.

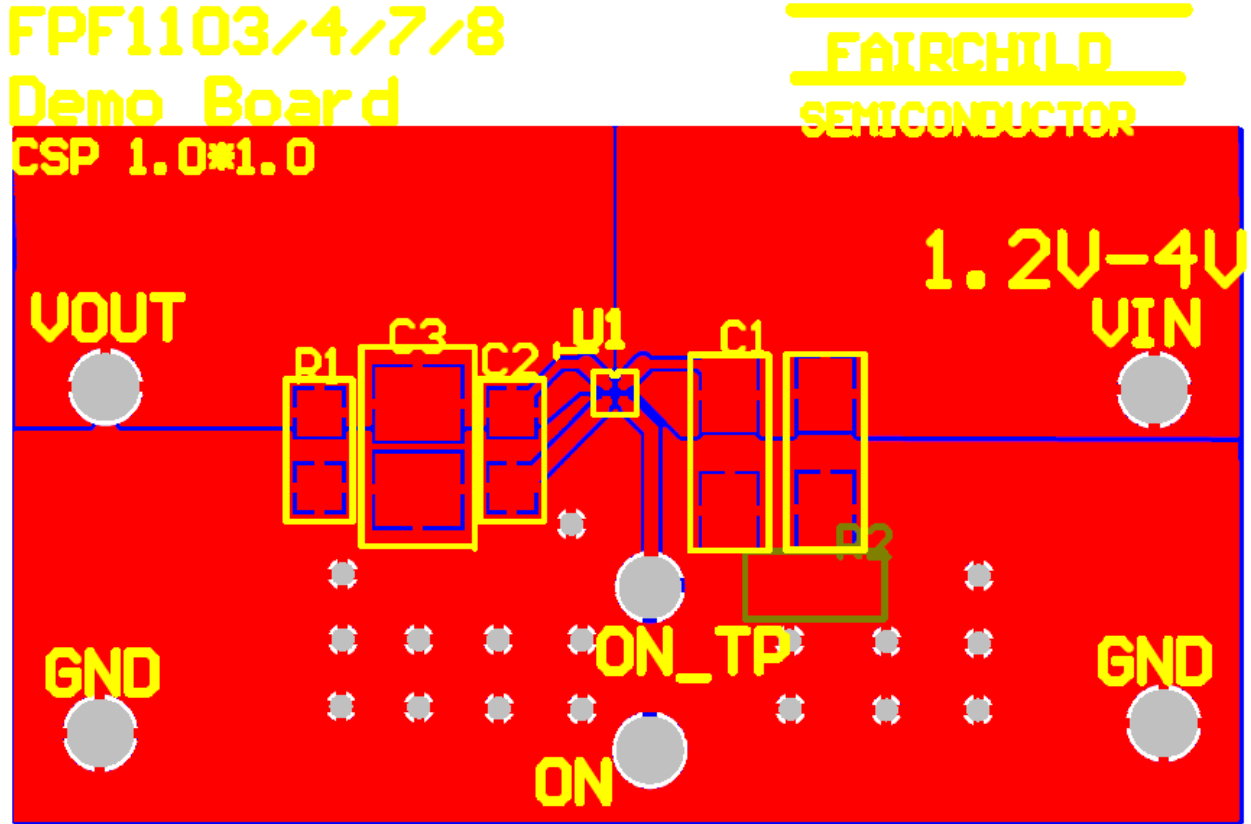
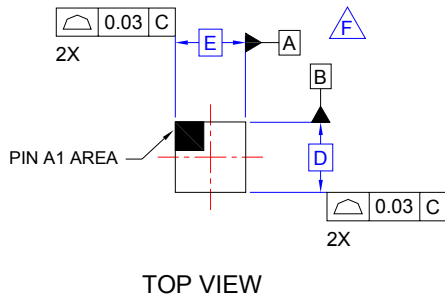
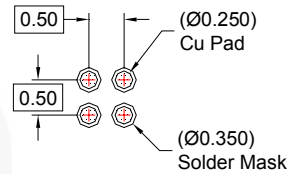


Figure 28. Recommended Land Pattern and Layout

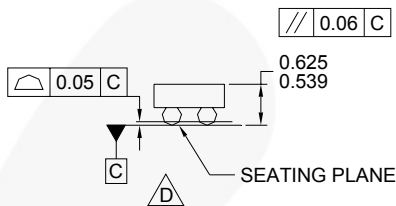
### Physical Dimensions



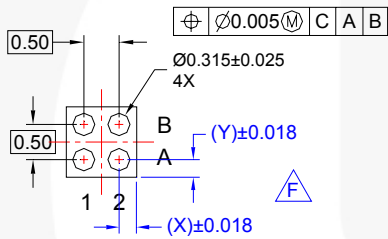
TOP VIEW



RECOMMENDED LAND PATTERN  
(NSMD PAD TYPE)



SIDE VIEWS



BOTTOM VIEW

#### NOTES:

- A. NO JEDEC REGISTRATION APPLIES.
- B. DIMENSIONS ARE IN MILLIMETERS.
- C. DIMENSIONS AND TOLERANCES PER ASME Y14.5M, 1994.
- D. DATUM C IS DEFINED BY THE SPHERICAL CROWNS OF THE BALLS.
- E. PACKAGE NOMINAL HEIGHT IS 582 MICRONS ±43 MICRONS (539-625 MICRONS).
- F. FOR DIMENSIONS D, E, X, AND Y SEE PRODUCT DATASHEET.
- G. DRAWING FILENAME: MKT-UC004ABrev2.

Figure 29. 4 Ball, 1.0 x 1.0mm Wafer Level Chip Scale WLCSP Packaging

### Product-Specific Dimensions

Product	D	E	X	Y
FPF1107	960µm ± 30µm	960µm ± 30µm	0.230mm	0.230mm
FPF1108	960µm ± 30µm	960µm ± 30µm	0.230mm	0.230mm

Package drawings are provided as a service to customers considering Fairchild components. Drawings may change in any manner without notice. Please note the revision and/or date on the drawing and contact a Fairchild Semiconductor representative to verify or obtain the most recent revision. Package specifications do not expand the terms of Fairchild's worldwide terms and conditions, specifically the warranty therein, which covers Fairchild products.

Always visit Fairchild Semiconductor's online packaging area for the most recent package drawings:  
<http://www.fairchildsemi.com/packaging/>.



**TRADEMARKS**

The following includes registered and unregistered trademarks and service marks, owned by Fairchild Semiconductor and/or its global subsidiaries, and is not intended to be an exhaustive list of all such trademarks.

AccuPower™  
Auto-SPM™  
Build it Now™  
CorePLUS™  
CorePOWER™  
CROSSVOL™  
CTL™  
Current Transfer Logic™  
EcoSPARK®  
EfficientMax™  
EZSWITCH™  
EZ™  
DEUXPEED™  
F®  
Fairchild®  
Fairchild Semiconductor®  
FACT Quiet Series™  
FACT®  
FAST®  
FastvCore™  
FETBench™

FlashWriter®  
FPS™  
F-PFS™  
FRFET®  
Global Power Resource SM  
Green FPS™  
Green FPS™ e-Series™  
Gmax™  
GTO™  
IntelliMAX™  
ISOPLANAR™  
MegaBuck™  
MICROCOUPLER™  
MicroFET™  
MicroPak™  
MillerDrive™  
MotionMax™  
Motion-SPM™  
OPTOLOGIC®  
OPTOPLANAR®  
PDP SPM™

Power-SPM™  
PowerTrench®  
PowerXST™  
Programmable Active Droop™  
QFET®  
QST™  
Quiet Series™  
RapidConfigure™  
Saving our world, 1mW/W/kW at a time™  
SignalWise™  
SmartMax™  
SMART START™  
SPM®  
STEALTH™  
SuperFET™  
SuperSOT™-3  
SuperSOT™-6  
SuperSOT™-8  
SupreMOS™  
SyncFET™  
Sync-Lock™

SYSTEM GENERAL®  
The Power Franchise®  
the power franchise  
TinyBoost™  
TinyBuck™  
TinyCalc™  
TinyLogic®  
TINYOPTO™  
TinyPower™  
TinyPWM™  
TinyWire™  
TriFault Detect™  
TRUECURRENT™  
µSerDes™  
UHC®  
Ultra FRFET™  
UniFET™  
VCX™  
VisualMax™  
XST™

\* Trademarks of System General Corporation, used under license by Fairchild Semiconductor.

**DISCLAIMER**

FAIRCHILD SEMICONDUCTOR RESERVES THE RIGHT TO MAKE CHANGES WITHOUT FURTHER NOTICE TO ANY PRODUCTS HEREIN TO IMPROVE RELIABILITY, FUNCTION, OR DESIGN. FAIRCHILD DOES NOT ASSUME ANY LIABILITY ARISING OUT OF THE APPLICATION OR USE OF ANY PRODUCT OR CIRCUIT DESCRIBED HEREIN; NEITHER DOES IT CONVEY ANY LICENSE UNDER ITS PATENT RIGHTS, NOR THE RIGHTS OF OTHERS. THESE SPECIFICATIONS DO NOT EXPAND THE TERMS OF FAIRCHILD'S WORLDWIDE TERMS AND CONDITIONS, SPECIFICALLY THE WARRANTY THEREIN, WHICH COVERS THESE PRODUCTS.

**LIFE SUPPORT POLICY**

FAIRCHILD'S PRODUCTS ARE NOT AUTHORIZED FOR USE AS CRITICAL COMPONENTS IN LIFE SUPPORT DEVICES OR SYSTEMS WITHOUT THE EXPRESS WRITTEN APPROVAL OF FAIRCHILD SEMICONDUCTOR CORPORATION.

As used herein:

1. Life support devices or systems are devices or systems which, (a) are intended for surgical implant into the body or (b) support or sustain life, and (c) whose failure to perform when properly used in accordance with instructions for use provided in the labeling, can be reasonably expected to result in a significant injury of the user.
2. A critical component in any component of a life support, device, or system whose failure to perform can be reasonably expected to cause the failure of the life support device or system, or to affect its safety or effectiveness.

**ANTI-COUNTERFEITING POLICY**

Fairchild Semiconductor Corporation's Anti-Counterfeiting Policy. Fairchild's Anti-Counterfeiting Policy is also stated on our external website, [www.fairchildsemi.com](http://www.fairchildsemi.com), under Sales Support.

Counterfeiting of semiconductor parts is a growing problem in the industry. All manufacturers of semiconductor products are experiencing counterfeiting of their parts. Customers who inadvertently purchase counterfeit parts experience many problems such as loss of brand reputation, substandard performance, failed applications, and increased cost of production and manufacturing delays. Fairchild is taking strong measures to protect ourselves and our customers from the proliferation of counterfeit parts. Fairchild strongly encourages customers to purchase Fairchild parts either directly from Fairchild or from Authorized Fairchild Distributors who are listed by country on our web page cited above. Products customers buy either from Fairchild directly or from Authorized Fairchild Distributors are genuine parts, have full traceability, meet Fairchild's quality standards for handling and storage and provide access to Fairchild's full range of up-to-date technical and product information. Fairchild and our Authorized Distributors will stand behind all warranties and will appropriately address any warranty issues that may arise. Fairchild will not provide any warranty coverage or other assistance for parts bought from Unauthorized Sources. Fairchild is committed to combat this global problem and encourage our customers to do their part in stopping this practice by buying direct or from authorized distributors.

**PRODUCT STATUS DEFINITIONS**

**Definition of Terms**

Datasheet Identification	Product Status	Definition
Advance Information	Formative / In Design	Datasheet contains the design specifications for product development. Specifications may change in any manner without notice.
Preliminary	First Production	Datasheet contains preliminary data; supplementary data will be published at a later date. Fairchild Semiconductor reserves the right to make changes at any time without notice to improve design.
No Identification Needed	Full Production	Datasheet contains final specifications. Fairchild Semiconductor reserves the right to make changes at any time without notice to improve the design.
Obsolete	Not In Production	Datasheet contains specifications on a product that is discontinued by Fairchild Semiconductor. The datasheet is for reference information only.

Rev. I43

ON Semiconductor and  are trademarks of Semiconductor Components Industries, LLC dba ON Semiconductor or its subsidiaries in the United States and/or other countries. ON Semiconductor owns the rights to a number of patents, trademarks, copyrights, trade secrets, and other intellectual property. A listing of ON Semiconductor's product/patent coverage may be accessed at [www.onsemi.com/site/pdf/Patent-Marking.pdf](http://www.onsemi.com/site/pdf/Patent-Marking.pdf). ON Semiconductor reserves the right to make changes without further notice to any products herein. ON Semiconductor makes no warranty, representation or guarantee regarding the suitability of its products for any particular purpose, nor does ON Semiconductor assume any liability arising out of the application or use of any product or circuit, and specifically disclaims any and all liability, including without limitation special, consequential or incidental damages. Buyer is responsible for its products and applications using ON Semiconductor products, including compliance with all laws, regulations and safety requirements or standards, regardless of any support or applications information provided by ON Semiconductor. "Typical" parameters which may be provided in ON Semiconductor data sheets and/or specifications can and do vary in different applications and actual performance may vary over time. All operating parameters, including "Typicals" must be validated for each customer application by customer's technical experts. ON Semiconductor does not convey any license under its patent rights nor the rights of others. ON Semiconductor products are not designed, intended, or authorized for use as a critical component in life support systems or any FDA Class 3 medical devices or medical devices with a same or similar classification in a foreign jurisdiction or any devices intended for implantation in the human body. Should Buyer purchase or use ON Semiconductor products for any such unintended or unauthorized application, Buyer shall indemnify and hold ON Semiconductor and its officers, employees, subsidiaries, affiliates, and distributors harmless against all claims, costs, damages, and expenses, and reasonable attorney fees arising out of, directly or indirectly, any claim of personal injury or death associated with such unintended or unauthorized use, even if such claim alleges that ON Semiconductor was negligent regarding the design or manufacture of the part. ON Semiconductor is an Equal Opportunity/Affirmative Action Employer. This literature is subject to all applicable copyright laws and is not for resale in any manner.

## PUBLICATION ORDERING INFORMATION

### LITERATURE FULFILLMENT:

Literature Distribution Center for ON Semiconductor  
19521 E. 32nd Pkwy, Aurora, Colorado 80011 USA  
**Phone:** 303-675-2175 or 800-344-3860 Toll Free USA/Canada  
**Fax:** 303-675-2176 or 800-344-3867 Toll Free USA/Canada  
**Email:** [orderlit@onsemi.com](mailto:orderlit@onsemi.com)

**N. American Technical Support:** 800-282-9855 Toll Free  
USA/Canada  
**Europe, Middle East and Africa Technical Support:**  
Phone: 421 33 790 2910  
**Japan Customer Focus Center**  
Phone: 81-3-5817-1050

**ON Semiconductor Website:** [www.onsemi.com](http://www.onsemi.com)  
**Order Literature:** <http://www.onsemi.com/orderlit>  
For additional information, please contact your local  
Sales Representative