



### FEATURES

- Up to 95% efficiency—no costly heat sinks or fans required
- 3.3V/2A & 5V/2A models; pin compatible with 1.5A 78xx regulators
- Wide 8–32Vdc input voltage range
- Two package options:  
3-pin vertical mount SIP  
Low profile, horizontal mount SIP
- No external Input/Output filter capacitors required
- –40 to +70°C full load operation at 24Vin with no derating
- Excellent load ( $\pm 0.25\%$ ) and line ( $\pm 0.35\%$ ) regulation
- Low-cost upgrade for 78HT2, 78SR1, 78ST1, and PT5100 switchers
- Open frame design minimizes self-heating & pc-board footprint
- Includes output short-circuit protection and thermal shutdown
- Low noise output for powering sensitive instrumentation

### Ordering Information

Part No.	Output Voltage	Output Current	Input Voltage	Package Type
78SR-3.3/2-C	3.3Vdc	2.0A	8.0-32Vdc	Vertical
78SR-5/2-C	5.0Vdc			
78SR-5.2/2-C	5.25Vdc			
78SRH-3.3/2-C	3.3Vdc			Horizontal
78SRH-5/2-C	5.0Vdc			
78SRH-5.2/2-C	5.25Vdc			

Murata's 78SR-3.3/2 (3.3V, 2 Amp output) and 78SR-5/2 (5V, 2 Amp output) step-down, switching regulators are ultra high-efficiency, modern replacements for LM78xx series 1.5Amp linear regulators. They are pin- and size-compatible, drop-in replacements for TO-220 style, 3-pin SIP or modular packages which require heat sinks. And, to ensure the lowest installed cost, no messy thermal grease, no mounting hardware and no external components are required for full operation.

A 200KHz switching frequency, combined with a synchronous rectifier buck regulator topology, provides for efficiencies exceeding 95%. 78SR switchers can easily drive 2A loads from 12V or 24Vsupplies—at ambient temperatures up to +70°C—without heat sinks, fans, or thermal derating. A thermally efficient 3-pin vertical mount SIP occupies less than 0.09in.<sup>2</sup> (58mm<sup>2</sup>) of pc-board real estate, while a horizontal mount option has an installed height of less than 0.290in. (7.4mm).

78SR Series 2A switching regulators are lower cost, improved-efficiency upgrades for many 78HT2, 78SR1, 78ST1, and PT5100 series switchers. Their higher efficiency ensures significantly lower heat generation and provides increased run time in battery-powered applications, making these regulators ideal for today's low power "green" applications.

### TECHNICAL NOTES

**1. Input/Output (I/O) Filtering:** As shown in the accompanying noise and ripple graphs, 78SR Series regulators exhibit excellent low noise performance with no additional I/O filter components. However, if additional noise reduction is required, be sure to use low ESR capacitors that are rated for continuous operation (with an additional 20% safety margin) at the highest input voltage and ambient temperatures. Adding external output capacitors will improve the unit's load-transient response.

Applications in which 78SR regulators are located more than 24 inches (61cm) from the input power supply should include an external 47uF/50V (or greater) aluminum electrolytic capacitor, connected as close as possible to the regulator's +Vin and GND terminals (pins 1 and 2). An external input capacitor is particularly important if the input voltage is applied to the regulator via a mechanical switch or relay. Contact bounce at turn-on can produce large inductive current spikes, and these current spikes can generate potentially damaging voltage transients at the regulator's input terminals.

**2. Input Fusing:** 78SR switching regulators are not internally fused. If fusing their input and/or output terminals is required, use the data shown in the Efficiency Curves as a guide to select an appropriate slow-blow fuse.



### Performance/Functional Specifications

Typical at  $T_A = +25^\circ\text{C}$  &  $V_{IN} = 12\text{V}$ , unless otherwise noted

Input/Output			
Models	78SR-3.3/2-C	78SR-5/2-C	78SR-5.2/2-C
Output Voltage	3.3Vdc	5.0Vdc	5.25Vdc
Rated Output Current	2.0A	2.0A	2.0A
Output Voltage Accuracy	$\pm 2\%$	$\pm 2\%$	$\pm 2\%$
Input Voltage Range	8.0-32Vdc	8.0-32Vdc	8.0-32Vdc
Line Regulation (100% load)	$\pm 0.35\%$	$\pm 0.35\%$	$\pm 0.35\%$
Load Regulation (0-100% load)	$\pm 0.2\%$	$\pm 0.2\%$	$\pm 0.2\%$
Quiescent Current (mAdc)	25 typ., 30 max	20 typ., 35max	20 typ., 35max
Input Current vs. Input Voltage	See Efficiency Curves		
Efficiency	See Efficiency Curves		
Transient Response	See Performance Curves		
Input & Output Noise	See Performance Curves		
Output Short Circuit Protection <sup>①</sup>	Continuous		
Input/Output Isolation	None		
Overvoltage Protection	None		
Undervoltage Protection	None		
Environmental			
Models	78SR-3.3/2-C	78SR-5/2-C	78SR-5.2/2-C
Operating Temperature	-40 to +70°C		
Storage Temperature	-40 to +85°C		
Cooling <sup>③</sup>	Free Air Convection		
Humidity (Non-condensing)	0 to 85%		
Physical			
Mechanical	See Mechanical Specifications		
Package	Open-frame SIP		
Pins	0.025" (0.64mm) square, tin-plated bronze		
Weight	0.15 ounces (4.2g)		
Pin Soldering	+260°C for 5 seconds		
Absolute Maximum Ratings <sup>②</sup>			
Input Voltage:	+36Vdc		
Operating Temperature	+85°C		
Output Current	3.0 Amps		

<sup>①</sup> 78SR Series regulators can withstand a continuous short-circuit across their output terminals. However, extended short-circuit operation will decrease the unit's long-term reliability.

<sup>②</sup> These are stress ratings only; Exposure of devices to any of these conditions may adversely affect long-term reliability. Proper operation under conditions other than those listed in the Performance/Functional Specifications Table is not implied.

<sup>③</sup> See derating chart for more information.

### TECHNICAL NOTES (continued)

**3. Input-Output Isolation:** 78SR regulators' internal input and output circuits share a common connection (GND, pin 2), **there is no electrical isolation** between their INPUT (pin 1) and OUTPUT (pin 3) terminals.

**4. Overvoltage Protection:** 78SR switching regulators do not provide input or output overvoltage protection. In the extremely rare situation where a catastrophic failure occurs, the output voltage may rise to excessively high levels. If the load circuit must be protected against all possible overvoltage situations, voltage-limiting circuitry must be provided externally.

**5. Soldering & Handling Precautions:** All units are designed to be hand soldered to pc-boards, using lead-free no-clean solders (+260°C, 5 seconds max.). See the Mechanical Specifications section for pin 1 orientation and recommended pc-board hole dimensions.

78SR series regulators have limited built-in ESD protection; therefore they should always be treated as ESD susceptible devices.

**6. Horizontal-Pin Models (78SRH):** 78SRH switching regulators are pin-compatible replacements for TO-220 style LM78xx linear regulators which are installed with their metal tabs or heat sinks laying flat on the surface of the pc-board. In replacement applications, 78SRH units must be soldered to the pc-board such that the insulating body of diode D1 lies flat and in contact with the pc-board's surface.

2 Amp, 3.3V, 5.0V, & 5.2V Output, High Efficiency, Synchronous Switching Regulators

Typical Performance Curves  $T_A = +25^\circ\text{C}$ ,  $V_{in}$  as indicated

### Noise and Ripple - 10% and 100% Load, 20 MHz Bandwidth

78SR-3.3/2  $V_{in} = 12\text{V}$ ,  $I_{LOAD} = 0.2\text{A}$

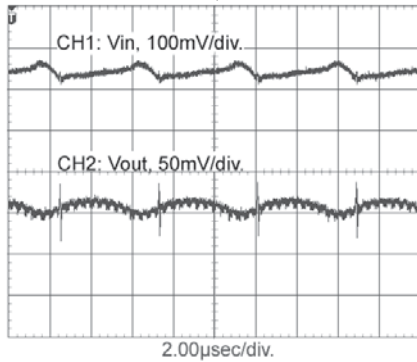

78SR-3.3/2  $V_{in} = 12\text{V}$ ,  $I_{LOAD} = 2.0\text{A}$

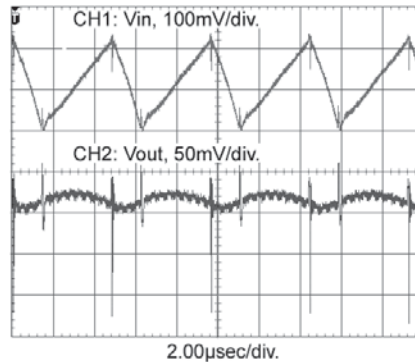

78SR-3.3/2  $V_{in} = 24\text{V}$ ,  $I_{LOAD} = 2.0\text{A}$

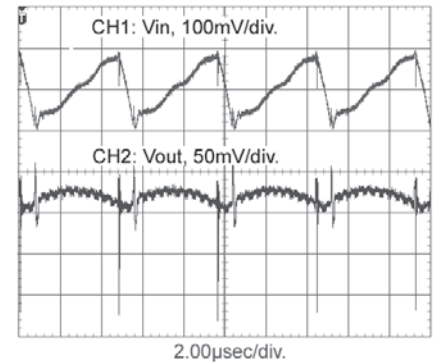

78SR-5/2  $V_{in} = 12\text{V}$ ,  $I_{LOAD} = 0.2\text{A}$

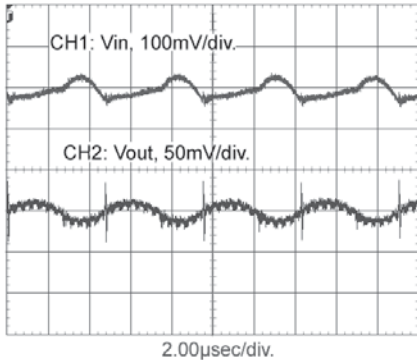

78SR-5/2  $V_{in} = 12\text{V}$ ,  $I_{LOAD} = 2.0\text{A}$

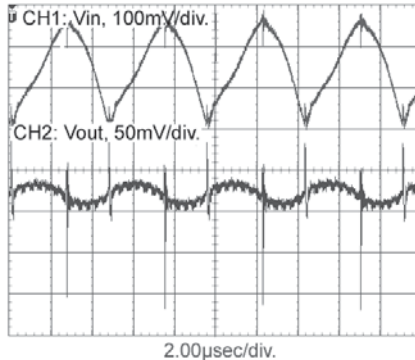

78SR-5/2  $V_{in} = 24\text{V}$ ,  $I_{LOAD} = 2.0\text{A}$

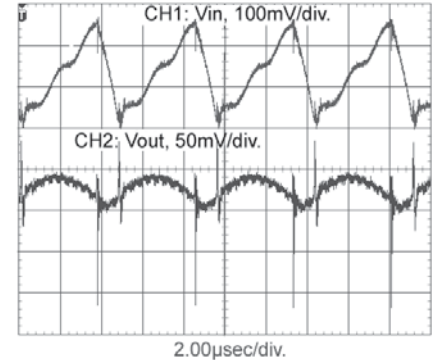

### Transient Response - 50% Load Step

78SR-3.3/2 25% to 75% Load Step

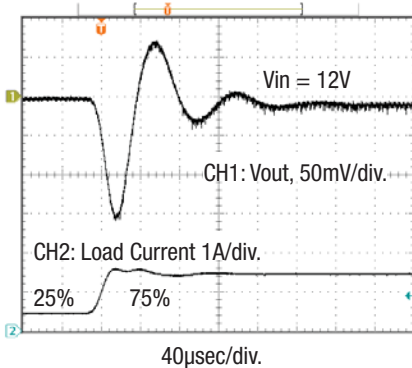

78SR-3.3/2 25% to 75% Load Step

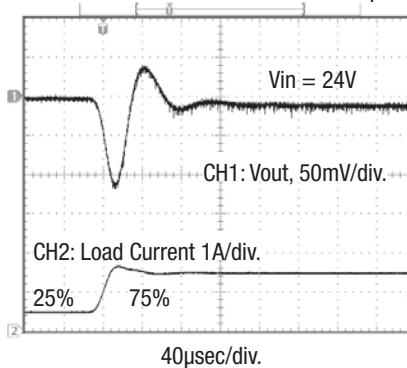

78SR-3.3/2 75% to 25% Load Step

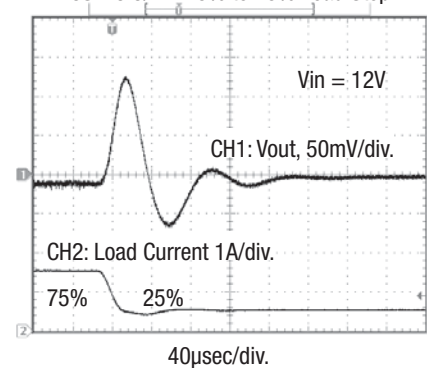

78SR-5/2 25% to 75% Load Step

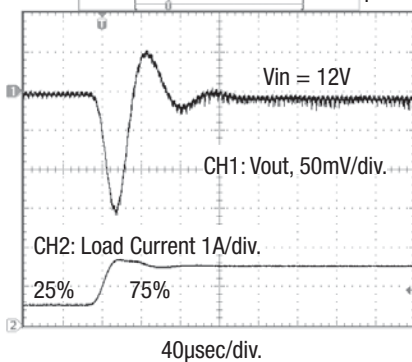

78SR-5/2 25% to 75% Load Step

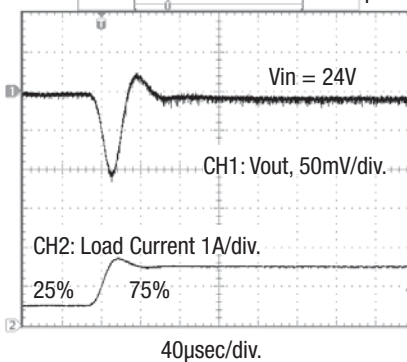

78SR-5/2 75% to 25% Load Step

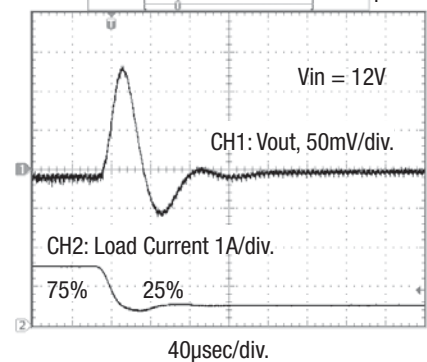

2 Amp, 3.3V, 5.0V, & 5.2V Output, High Efficiency, Synchronous Switching Regulators

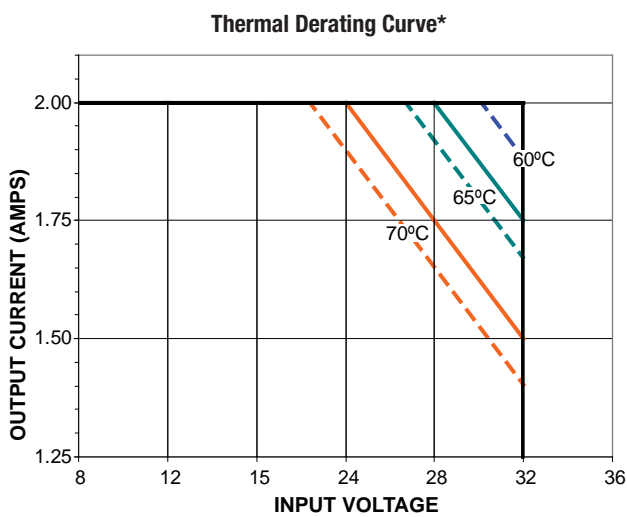
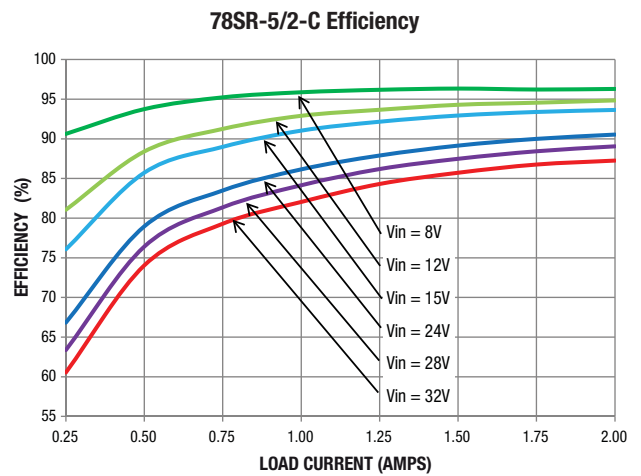
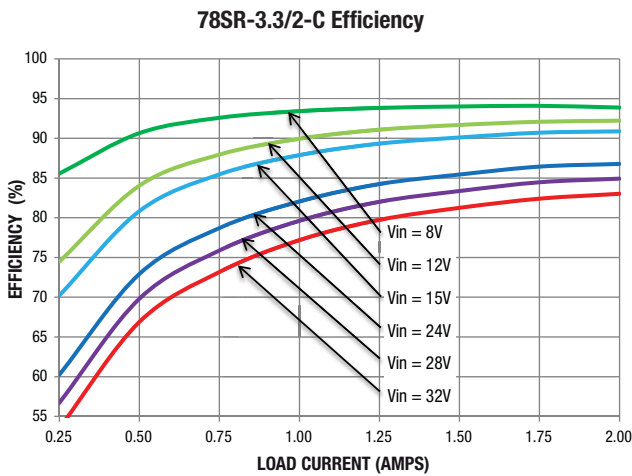
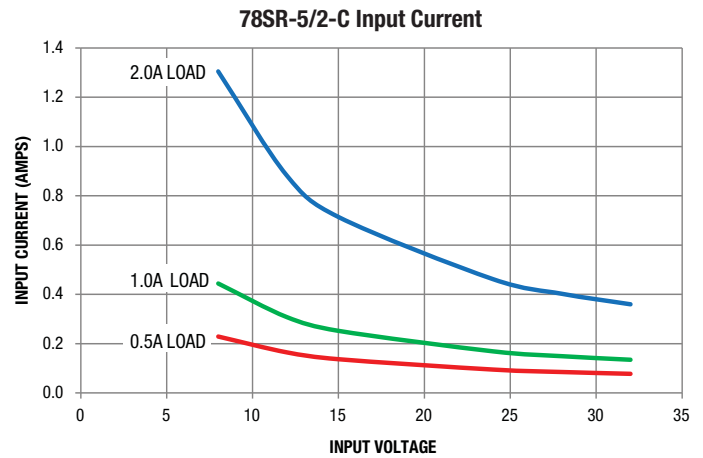
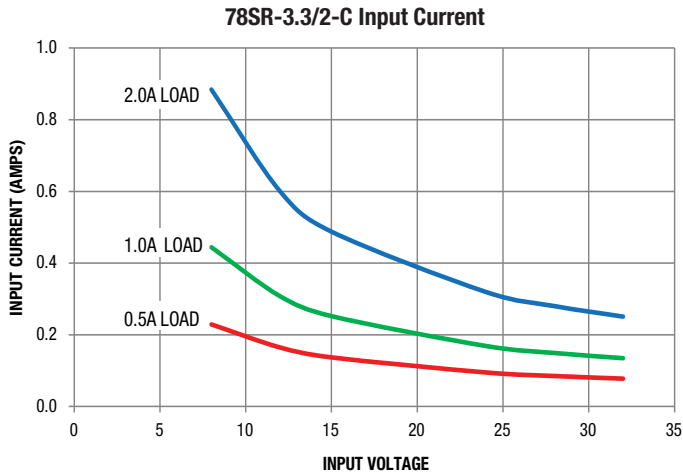

\*Solid lines are for 3.3V and 5.0V models; dashed lines are for 5.2V models.

SHIPPING TRAYS AND BOXES

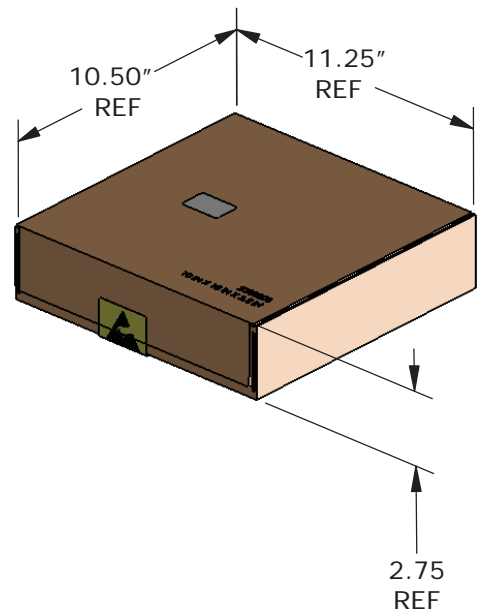
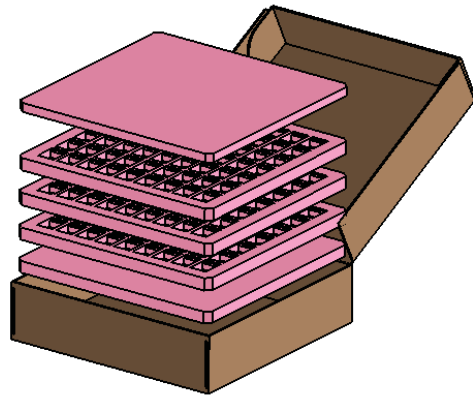

EACH FOAM TRAY CONTAINS 63 UNITS. IN FULL MPQ QUANTITIES, THREE TRAYS EQUAL TO A TOTAL OF 189 (3x63) UNITS PER BOX.

MECHANICAL DIMENSIONS: Inches (mm)

TOLERANCES: 2 PL DEC  $\pm 0.02$  ( $\pm 0.51$ )  
3 PL DEC  $\pm 0.010$  ( $\pm 0.254$ )

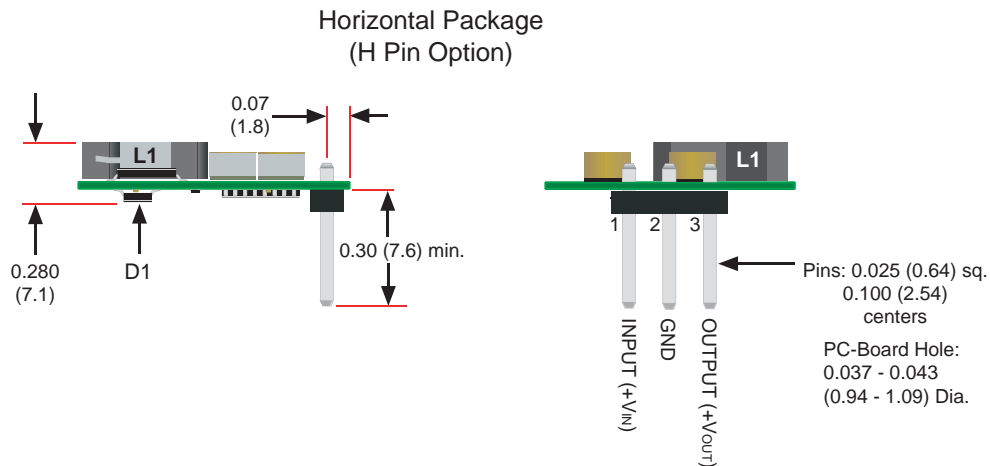
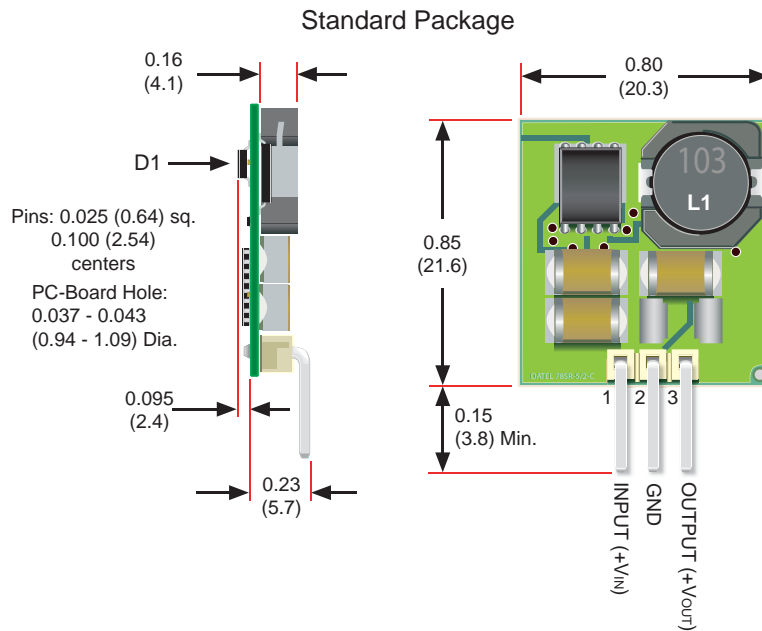

Murata Power Solutions, Inc.  
11 Cabot Boulevard, Mansfield, MA 02048-1151 U.S.A.  
ISO 9001 and 14001 REGISTERED



**This product is subject to the following operating requirements and the Life and Safety Critical Application Sales Policy:**  
Refer to: <http://www.murata-ps.com/requirements/>

Murata Power Solutions, Inc. makes no representation that the use of its products in the circuits described herein, or the use of other technical information contained herein, will not infringe upon existing or future patent rights. The descriptions contained herein do not imply the granting of licenses to make, use, or sell equipment constructed in accordance therewith. Specifications are subject to change without notice. © 2017 Murata Power Solutions, Inc.