

DIN W48×H48mm, Universal Voltage Multi-Function Timer

■ Features

- Realization of wide range of power supply
:100-240VAC 50/60Hz, 24-240VDC universal,
24VAC 50/60Hz, 24VDC universal, 12VDC
- Various output operation (6 kinds modes)
- Multi time range (16 kinds of time range)
- Wide control time (0.05 sec to 100 hour)
- Easy setting of time, time range, output operation mode
- Easy to check output status by indicator



⚠ Please read "Safety Considerations" in the instruction manual before using.



■ Ordering Information

AT	8	N	-		
Item	Number of plug pins	Time operation	Power supply	No mark	100-240VAC 50/60Hz, 24-240VDC
				1	12VDC
				2	24VAC 50/60Hz, 24VDC
				N	Time limit DPDT (2c) or instantaneous SPDT (1c)+Time limit SPDT (1c) selectable by output operation mode
				DN	Time limit DPDT (2c)
				EN	Instantaneous SPDT (1c)+Time limit SPDT (1c)
Item	Number of plug pins	8	8-pin plug type		
		11	11-pin plug type		
				AT	Analog Timer

※8-pin socket (PG-08, PS-08(N), PS-08) and 11-pin socket (PG-11, PS-11(N)) are sold separately.

■ Specifications

Model	AT8N-□	AT11DN-□	AT11EN-□
Function	Multi Function Timer		
Control time setting range※1	0.05 sec to 100 hour		
Power supply	• 100-240VAC~ 50/60Hz, 24-240VDC≡ universal • 24VAC~ 50/60Hz, 24VDC≡ universal • 12VDC≡		
Allowable voltage range	90 to 110% of rated voltage		
Power consumption	<ul style="list-style-type: none"> • Max. 4.3VA (100-240VAC~), Max. 2W (24-240VDC≡) • Max. 4.5VA (24VAC~), Max. 2W (24VDC≡) • Max. 1.5W (12VDC≡) 	<ul style="list-style-type: none"> • Max. 3.5VA (100-240VAC~), Max. 1.5W (24-240VDC≡) • Max. 4VA (24VAC~), Max. 1.5W (24VDC≡) • Max. 1W (12VDC≡) 	<ul style="list-style-type: none"> • Max. 4.3VA (100-240VAC~), Max. 2W (24-240VDC≡) • Max. 4.5VA (24VAC~), Max. 2W (24VDC≡) • Max. 1.5W (12VDC≡)
Return time	Max. 100ms		
Timing operation	Power ON Start	Signal ON Start	
Min. input signal width	—	INHIBIT, START, RESET: approx. 50ms	
Input	—	INHIBIT, START, RESET: [No-voltage input] - Short-circuit impedance: max. 1kΩ, Residual voltage: max. 0.5V, Open-circuit impedance: min. 100kΩ	
Control output	Contact type	Time limit DPDT (2c) or Instantaneous SPDT (1c)+ Time limit SPDT (1c) selectable by output operation mode	Time limit DPDT (2c) Instantaneous SPDT (1c)+ Time limit SPDT (1c)
	Contact capacity	250VAC~ 5A, 30VDC≡ 5A resistive load	250VAC~ 5A, 24VDC≡ 5A resistive load
Relay life cycle	Mechanical	Min. 10,000,000 operations	
	Electrical	Min. 100,000 operations (250VAC 5A resistive load)	
Repeat error	Max. ±0.2% ±10ms		
SET error	Max. ±5% ±50ms		
Voltage error	Max. ±0.5%		
Temperature error	Max. ±2%		
Insulation resistance	Over 100MΩ (at 500VDC megger)		

※1: Refer to time specifications for control time setting range by model.

SENSORS

CONTROLLERS

MOTION DEVICES

SOFTWARE

(J) Temperature Controllers

(K) SSRs

(L) Power Controllers

(M) Counters

(N) Timers

(O) Digital Panel Meters

(P) Indicators

(Q) Converters

(R) Digital Display Units

(S) Sensor Controllers

(T) Switching Mode Power Supplies

(U) Recorders

(V) HMIs

(W) Panel PC

(X) Field Network Devices

ATN Series

Specifications

Model	AT8N-□	AT11DN-□	AT11EN-□
Dielectric strength	2,000VAC 50/60Hz for 1 min		
Noise immunity	AT□□-1	±500V the square wave noise (pulse width 1μs) by noise simulator	
	AT□□-2		
	AT□□	±2kV the square wave noise (pulse width 1μs) by noise simulator	
Vibration	Mechanical	0.75mm amplitude at frequency of 10 to 55Hz (for 1 min) in each X, Y, Z direction for 1 hour	
	Malfunction	0.5mm amplitude at frequency of 10 to 55Hz (for 1 min) in each X, Y, Z direction for 10 min	
Shock	Mechanical	300m/s ² (approx. 30G) in each X, Y, Z direction 3 times	
	Malfunction	100m/s ² (approx. 10G) in each X, Y, Z direction 3 times	
Environment	Ambient temperature	-10 to 55°C, storage: -25 to 65°C	
	Ambient humidity	35 to 85%RH, storage: 35 to 85%RH	
Approval	CE  us		
Accessory	Bracket		
Weight ^{※2}	Approx. 134.12g (approx. 86.71g)	Approx. 132.2g (approx. 85g)	Approx. 134.7g (approx. 87.5g)

※2: The weight includes packaging. The weight in parenthesis is for unit only.
 ※Environment resistance is rated at no freezing or condensation.

Connections

AT8N

- When selecting [A], [F] output operation mode

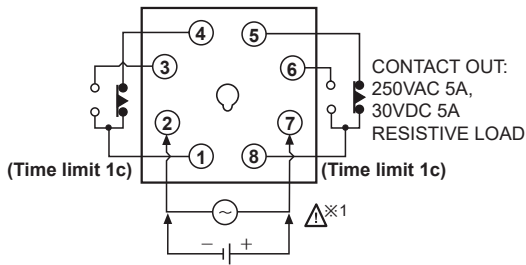

- When selecting [A1], [B], [F1], [I] output operation mode

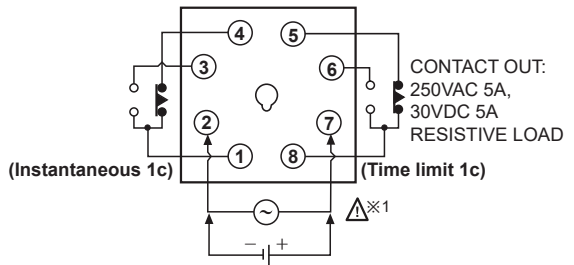

※1: AC/DC voltage: 100-240VAC 50/60Hz, 24-240VDC
 : 24VAC 50/60Hz, 24VDC
 DC voltage: 12VDC

AT11DN

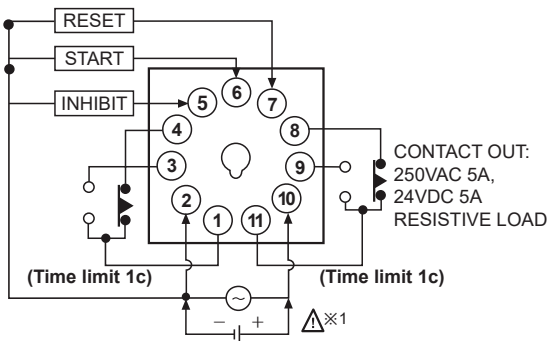

AT11EN

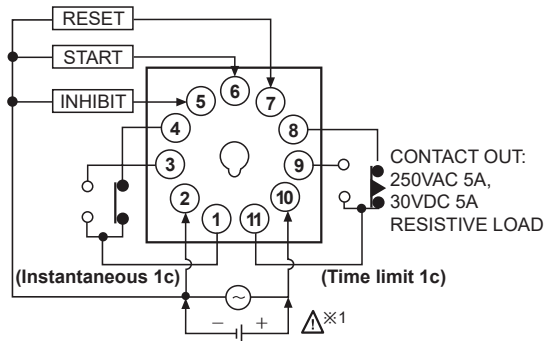

※1: AC/DC voltage: 100-240VAC 50/60Hz, 24-240VDC
 : 24VAC 50/60Hz, 24VDC
 DC voltage: 12VDC

Multi Function Analog Timer

■ Dimensions

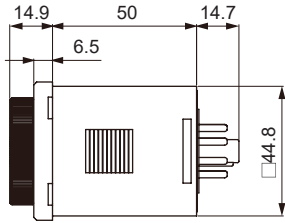
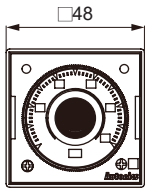

(unit: mm)

○ Bracket

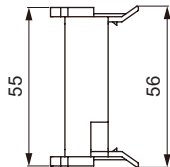
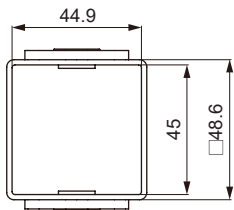
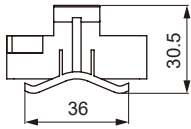

○ Panel cut-out

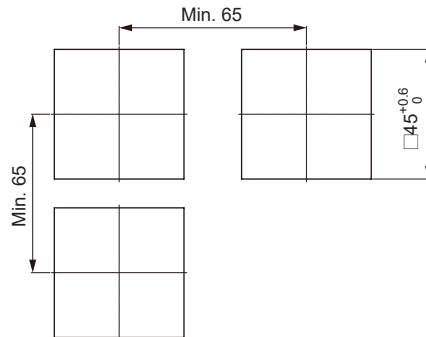

■ Unit Description

Operation/Power indicator
(Flashes for timer operation,
Turns ON for timer stop)

Time range indication

Time range setting switch

Time unit indication
(SEC, MIN, HOUR, 10H mode)

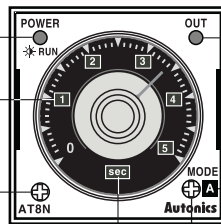

Time limit output indication

Output operation mode display part

AT8N
(A, A1, B, F, F1, I mode)
AT11DN/AT11EN
(A, F, F1, C, D, I mode)

Output operation mode setting switch

■ Time Specifications

Time range	Time unit	Time setting range	Time range	Time unit	Time setting range
0.5	SEC	0.05 to 0.5 sec	0.5	HOUR	0.05 to 0.5 hour
1		0.1 to 1 sec	1		0.1 to 1 hour
5		0.5 to 5 sec	5		0.5 to 5 hour
10		1 to 10 sec	10		1 to 10 hour
0.5	MIN	0.05 to 0.5 min	0.5	10H	0.5 to 5 hour
1		0.1 to 1 min	1		1 to 10 hour
5		0.5 to 5 min	5		5 to 50 hour
10		1 to 10 min	10		10 to 100 hour

■ Output Operation Mode

● AT8N

Display	Output operation mode
A	Power ON Delay
A1	Power ON Delay1 (One-Shot output)
B	Power ON Delay2
F	Flicker (OFF Start)
F1	Flicker1 (ON Start)
I	Interval

● AT11DN/AT11EN

Display	Output operation mode
A	Signal ON Delay
F	Flicker (OFF Start)
F1	Flicker1 (ON Start)
C	Signal OFF Delay
D	Signal ON/OFF Delay
I	Interval

SENSORS
CONTROLLERS
MOTION DEVICES
SOFTWARE
(J) Temperature Controllers
(K) SSRs
(L) Power Controllers
(M) Counters
(N) Timers
(O) Digital Panel Meters
(P) Indicators
(Q) Converters
(R) Digital Display Units
(S) Sensor Controllers
(T) Switching Mode Power Supplies
(U) Recorders
(V) HMIs
(W) Panel PC
(X) Field Network Devices

ATN Series

Output Operation Mode (AT8N)

[t: Setting time, $t > t-a$, Rt: Return time, $Rt1 > Rt$]

Mode	Time chart		
A			
Power ON Delay			
A1			
Power ON Delay1 (One-Shot output)			
B			
Power ON Delay2			
F			
Flicker (OFF Start)			
F1			
Flicker1 (ON Start)			
I			
Interval			

※In case of F, F1 output operation mode, setting time should be over 100ms.
If not, it may cause abnormal output operation due to under 100ms of setting time.

Multi Function Analog Timer

Output Operation Mode (AT11DN/AT11EN)

[t: Setting time, $t=t_1+t_2$, $t>t-a$]

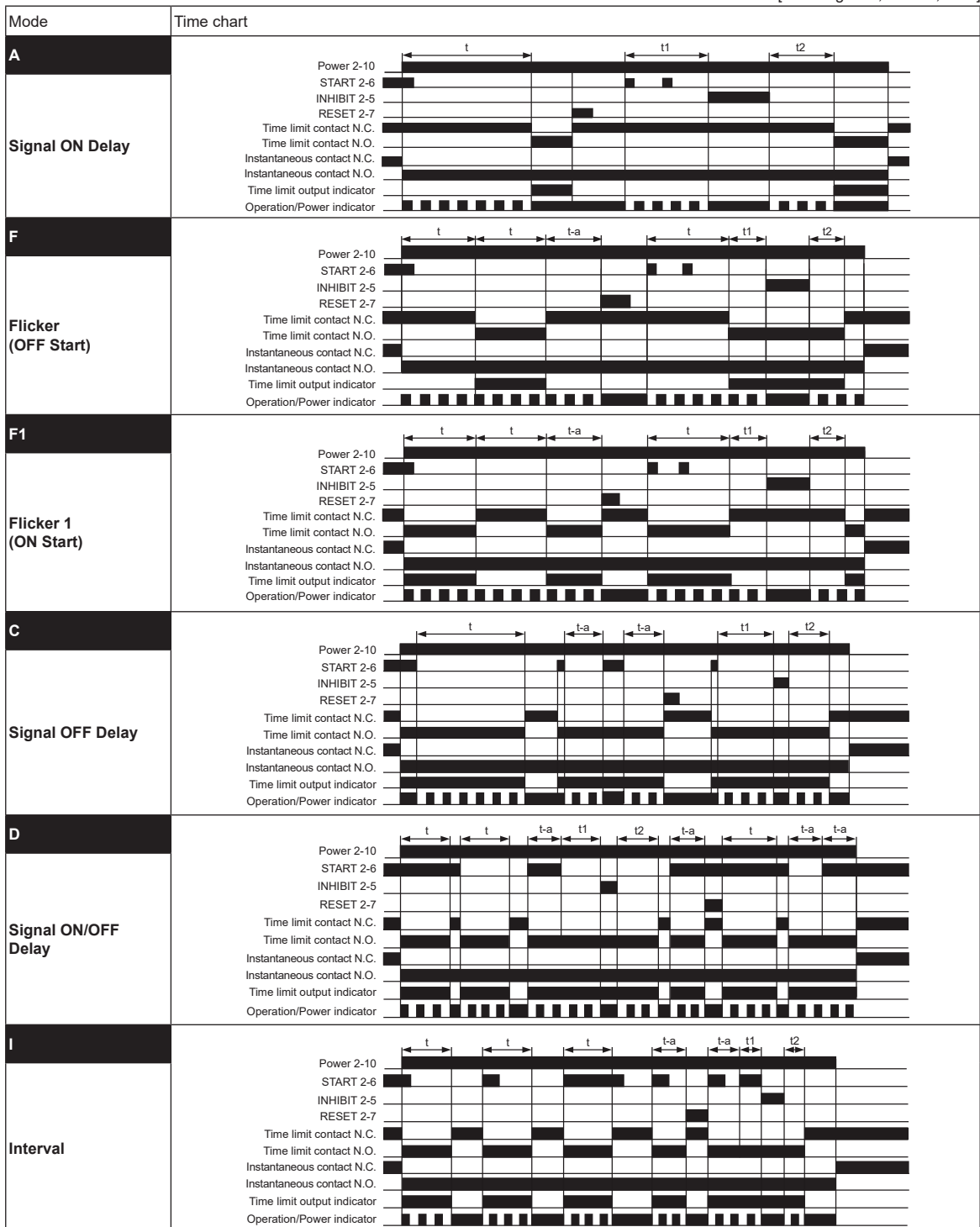

※AT11EN-□ model only supports Instantaneous contact.

※If power is cut or the RESET terminal is short-circuited, the timer will be RESET.

※If the INHIBIT terminal is short-circuited during a time limit operation, the time will stop.

※In case of F, F1 output operation mode, setting time should be over 100ms.

If not, it may cause abnormal output operation due to under 100ms of setting time.

SENSORS

CONTROLLERS

MOTION DEVICES

SOFTWARE

(J) Temperature Controllers

(K) SSRs

(L) Power Controllers

(M) Counters

(N) Timers

(O) Digital Panel Meters

(P) Indicators

(Q) Converters

(R) Digital Display Units

(S) Sensor Controllers

(T) Switching Mode Power Supplies

(U) Recorders

(V) HMIs

(W) Panel PC

(X) Field Network Devices

ATN Series

■ Proper Usage

- Follow instructions in 'Proper Usage'. Otherwise, it may cause unexpected accidents.
- 12VDC, 24VDC, 24VAC power supply should be insulated and limited voltage/current or Class 2, SELV power supply device.
- When supplying or turning off the power, use a switch or etc. to avoid chattering.
- Install a power switch or circuit breaker in the easily accessible place for supplying or disconnecting the power.
- In order to avoid leakage current flowing, connect resistance and condenser as (Figure 2).
If connect as (Figure 1), it may cause malfunction due to leakage current.

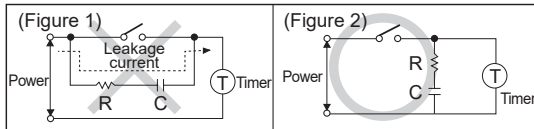

- Keep away from high voltage lines or power lines to prevent inductive noise.
In case installing power line and input signal line closely, use line filter or varistor at power line and shielded wire at input signal line.
Do not use near the equipment which generates strong magnetic force or high frequency noise.
- Change setting time, time range, operation mode or etc. after turning off the power of the timer.
- This unit may be used in the following environments.
 - ① Indoors (in the environment condition rated in 'Specifications')
 - ② Altitude max. 2,000m
 - ③ Pollution degree 2
 - ④ Installation category II