

# Automotive Ferrite Chip Beads



**AFBC-Q0402**

Request Samples



Check Inventory



1.00 x 0.5 x 0.5 mm  
RoHS/RoHS II Compliant  
MSL Level = 1

## Features

- AEC-Q200 Qualified
- Operating Temperature: -55 ~ +150°C
- Wide range impedance
- Monolithic inorganic material construction
- Excellent heat resistance

## Applications

- Electronic control Units (ECUs)
- RF transceiver modules
- Antennas
- Infotainment system
- ADAS
- Industrial connectivity (IIoT)

## Electrical Specifications

Part Number	Impedance	DC Resistance	Rated Current
Units	$\Omega \pm 25\%$	$\Omega$ Max.	mA Max.
Symbol	Z	R <sub>DC</sub>	I <sub>R</sub>
AFBC-Q0402-300	30	0.20	300
AFBC-Q0402-600	60	0.25	300
AFBC-Q0402-121	120	0.30	100
AFBC-Q0402-151	150	0.30	100
AFBC-Q0402-221	220	0.40	100
AFBC-Q0402-301	300	0.50	100
AFBC-Q0402-471	470	0.65	100
AFBC-Q0402-601	600	0.80	80
AFBC-Q0402-102	1000	1.20	50

### Test Conditions and Equipment

Impedance Test Frequency: 100MHz

IR: Rated current applied when the chip surface temperature rise just 20°C against chip surface temperature.

**Operating Temperature:** -55°C to +150°C (Including Self-Temperature rise)

**Storage Temperature:** <+40°C and RH 60% (Max).

**AFBC-Q0402 is RoHS Compliant and Pb free**

# Automotive Ferrite Chip Beads

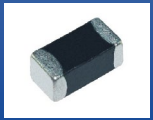

**AFBC-Q0402**

Request Samples



Check Inventory



**1.00 x 0.5 x 0.5 mm**  
**RoHS/RoHS II Compliant**  
**MSL Level = 1**

## Electrical Specifications (Cont'd)

AFBC-Q0402-300

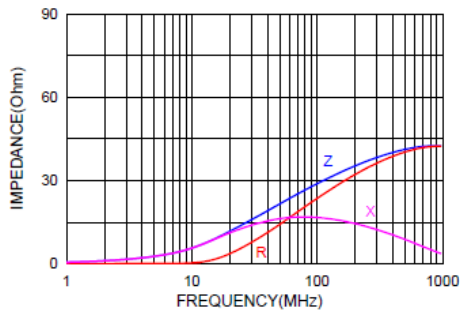

AFBC-Q0402-600

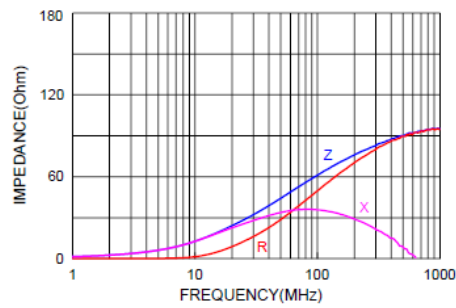

AFBC-Q0402-121

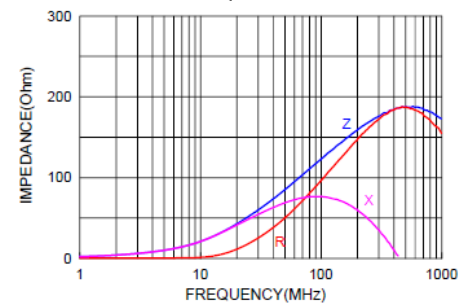

AFBC-Q0402-151

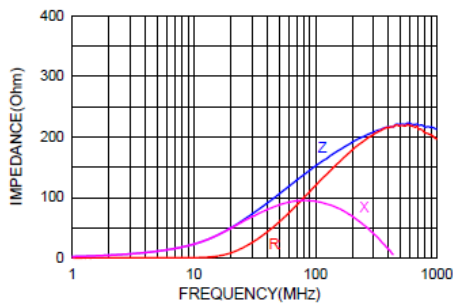

AFBC-Q0402-221

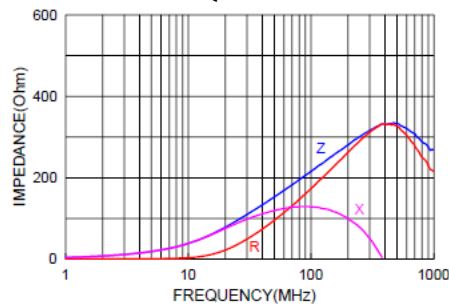

AFBC-Q0402-301

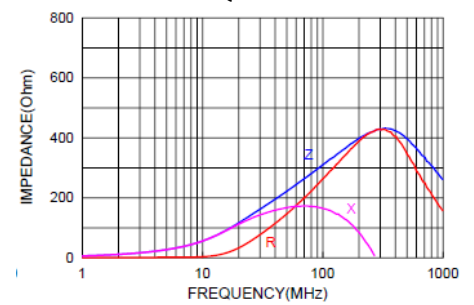

AFBC-Q0402-471

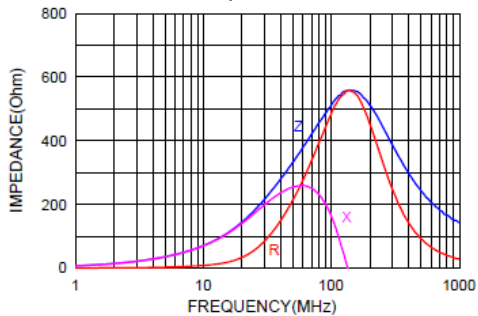

AFBC-Q0402-601

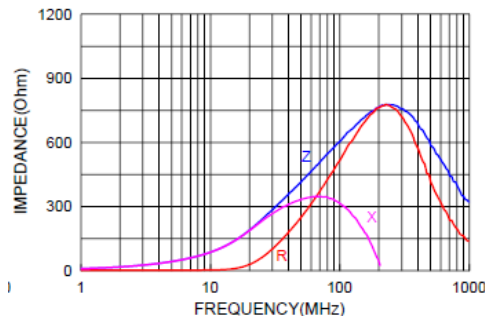

AFBC-Q0402-102

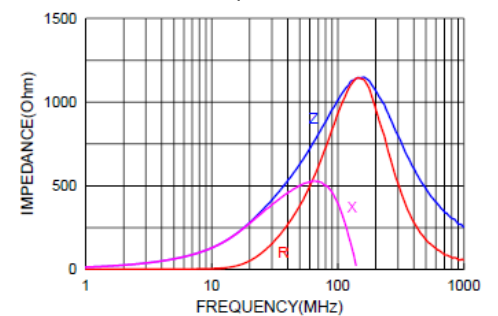

5101 Hidden Creek Ln Spicewood TX 78669  
 Phone: 512-371-6159 | Fax: 512-351-8858  
 For terms and conditions of sales, please visit:  
[www.abracon.com](http://www.abracon.com)

REVISION: IR 08-10-22

ABRACON IS  
 ISO9001-2015  
 CERTIFIED

# Automotive Ferrite Chip Beads



**AFBC-Q0402**

Request Samples



Check Inventory



**1.00 x 0.5 x 0.5 mm**  
**RoHS/RoHS II Compliant**  
**MSL Level = 1**

## Part Number Identification

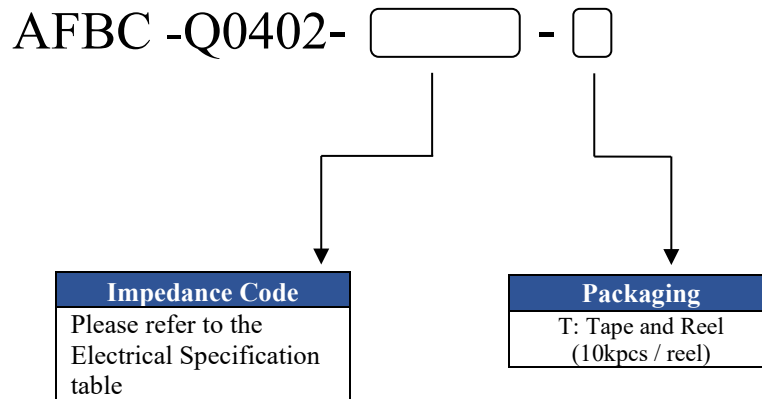

## Mechanical Specifications

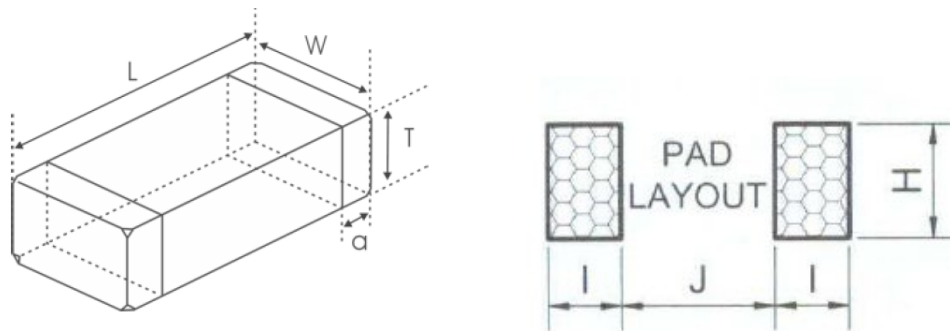

L	W	T	a	H	I	J
1.00±0.10	0.50±0.10	0.50±0.10	0.25±0.10	0.6 Ref.	0.50 Ref.	0.40 Ref.

**Dimension: mm**

# Automotive Ferrite Chip Beads



AFBC-Q0402

Request Samples



Check Inventory



1.00 x 0.5 x 0.5 mm  
**RoHS/RoHS II Compliant**  
 MSL Level = 1

## Materials

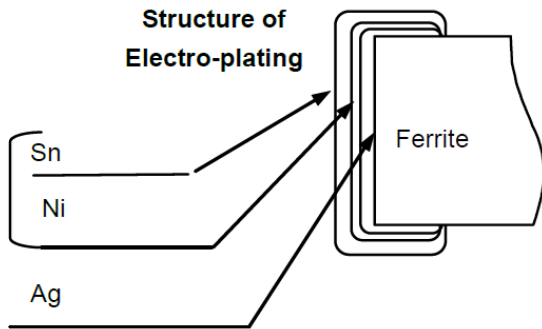

	Structure Description
1	Ferrite for Beads
2	Internal Terminal Electrode: Ag (100%)
3	Electro-plating: Ni (100%)
4	External Electro-plating: Sn (100%)

## Reflow Profile

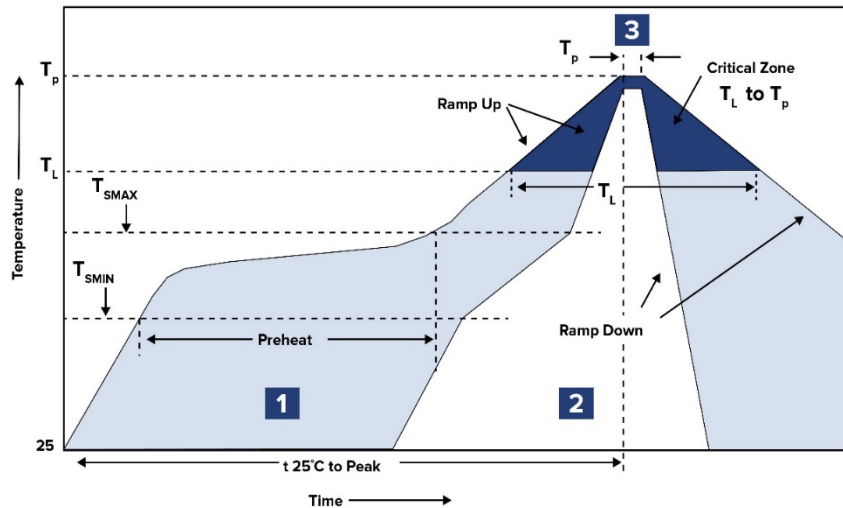

Zone	Description	Temperature	Times
1	Preheat	$T_{SMIN} \sim T_{SMAX}$ 150°C ~ 200°C	60 ~ 180 sec.
2	Reflow	$T_L$ 245°C	20 ~ 40 sec.
3	Peak heat	$T_P$ 260°C	10 sec. MAX

# Automotive Ferrite Chip Beads



**AFBC-Q0402**

Request Samples



Check Inventory



**1.00 x 0.5 x 0.5 mm**  
**RoHS/RoHS II Compliant**  
**MSL Level = 1**

## Packaging

**T= Tape and reel (10,000 pcs/reel)**

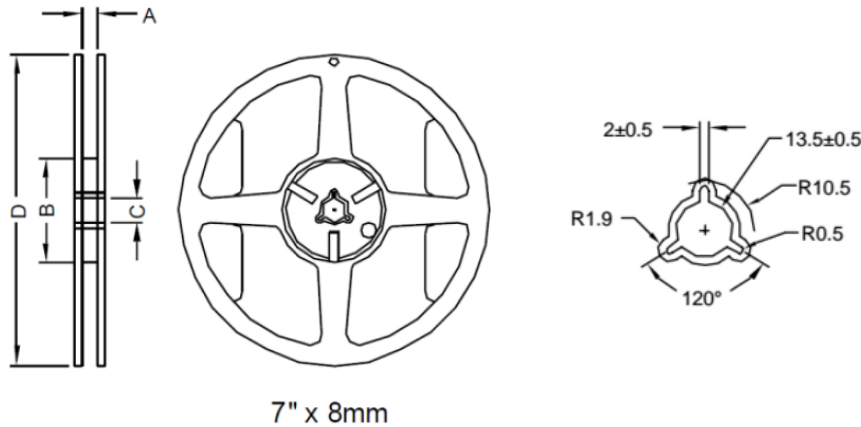

Type	A	B	C	D
7"x8mm	9.0 ± 0.5	60.0 ± 2.0	13.5 ± 0.5	178.0 ± 2.0

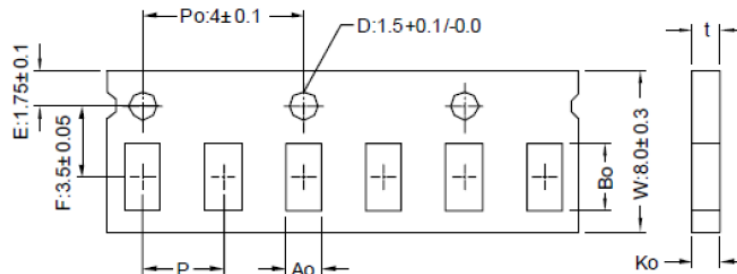

Series	Bo	Ao	Ko	P
AFBC-Q0402	1.12 ± 0.03	0.62 ± 0.03	0.60 ± 0.03	2.0 ± 0.05

**Dimension: mm**

**ATTENTION:** Abracon LLC's products are COTS – Commercial-Off-The-Shelf products; suitable for Commercial, Industrial and, where designated, Automotive Applications. Abracon's products are not specifically designed for Military, Aviation, Aerospace, Life-dependent Medical applications or any application requiring high reliability where component failure could result in loss of life and/or property. For applications requiring high reliability and/or presenting an extreme operating environment, written consent and authorization from Abracon LLC is required. Please contact Abracon LLC for more information.



5101 Hidden Creek Ln Spicewood TX 78669  
 Phone: 512-371-6159 | Fax: 512-351-8858  
 For terms and conditions of sales, please visit:  
[www.abracon.com](http://www.abracon.com)

**REVISION: IR 08-10-22**

ABRACON IS  
 ISO9001-2015  
 CERTIFIED