

## FEATURES

- High performance, dual-axis accelerometer on a single IC**
- $-40^{\circ}\text{C}$  to  $+175^{\circ}\text{C}$  ambient temperature range**
- Long life: guaranteed 1000 hours at  $T_A = 175^{\circ}\text{C}$**
- 13 mm  $\times$  8 mm  $\times$  2 mm side-brazed ceramic dual in-line package**
- 1 mg resolution at 60 Hz**
- Low power: 700  $\mu\text{A}$  at  $V_S = 5\text{ V}$  (typical)**
- High zero  $g$  bias repeatability**
- High sensitivity accuracy**
- Bandwidth adjustment with a single capacitor**
- Single-supply operation**
- RoHS-compliant**
- Compatible with Sn/Pb and Pb-free solder processes**

## APPLICATIONS

- Geological exploration tilt and vibration measurement**
- Extreme high temperature industrial products**

## GENERAL DESCRIPTION

The **ADXL206** is a precision, low power, complete dual-axis *i*MEMS<sup>®</sup> accelerometer for use in high temperature environments. The accelerometer integrates the sensor with signal conditioned voltage outputs on a single, monolithic IC.

The **ADXL206** measures acceleration with a full-scale range of  $\pm 5 g$ . The **ADXL206** can measure both dynamic acceleration (for example, vibration) and static acceleration (for example, gravity).

The typical noise floor is  $110 \mu\text{g}/\sqrt{\text{Hz}}$ , allowing signals below 1 mg ( $0.06^{\circ}$  of inclination) to be resolved in tilt sensing applications using narrow bandwidths ( $< 60\text{ Hz}$ ).

The user selects the bandwidth of the accelerometer using Capacitors  $C_X$  and  $C_Y$  at the  $X_{\text{OUT}}$  and  $Y_{\text{OUT}}$  pins, respectively. Bandwidths of 0.5 Hz to 2.5 kHz can be selected to suit the application.

The **ADXL206** is available in a 13 mm  $\times$  8 mm  $\times$  2 mm, 8-lead, side-brazed ceramic dual in-line package (SBDIP).

## FUNCTIONAL BLOCK DIAGRAM

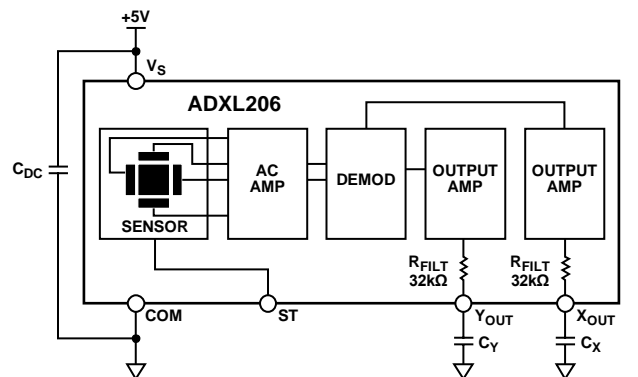

Figure 1.

Rev. B

[Document Feedback](#)

Information furnished by Analog Devices is believed to be accurate and reliable. However, no responsibility is assumed by Analog Devices for its use, nor for any infringements of patents or other rights of third parties that may result from its use. Specifications subject to change without notice. No license is granted by implication or otherwise under any patent or patent rights of Analog Devices. Trademarks and registered trademarks are the property of their respective owners.

One Technology Way, P.O. Box 9106, Norwood, MA 02062-9106, U.S.A.  
 Tel: 781.329.4700 ©2011–2015 Analog Devices, Inc. All rights reserved.  
[Technical Support](#) [www.analog.com](http://www.analog.com)

**TABLE OF CONTENTS**

Features .....	1	Performance .....	9
Applications.....	1	Applications Information .....	10
General Description .....	1	Power Supply Decoupling .....	10
Functional Block Diagram .....	1	Setting the Bandwidth Using $C_X$ and $C_Y$ .....	10
Revision History .....	2	Self-Test .....	10
Specifications.....	3	Design Trade-Offs for Selecting Filter Characteristics:	
Absolute Maximum Ratings.....	4	Noise/Bandwidth Trade-Off.....	10
Thermal Resistance .....	4	Using the ADXL206 with Operating Voltages Other Than	
ESD Caution.....	4	5 V .....	11
Pin Configuration and Function Descriptions.....	5	Using the ADXL206 As a Dual-Axis Tilt Sensor .....	11
Typical Performance Characteristics .....	6	Outline Dimensions .....	12
Theory of Operation .....	9	Ordering Guide .....	12

**REVISION HISTORY**

<b>4/15—Rev. A to Rev. B</b>	
Changes to Note 3, Table 1 .....	3
<b>1/14—Rev. 0 to Rev. A</b>	
Changes to Figure 3.....	5
<b>4/11—Revision 0: Initial Version</b>	

## SPECIFICATIONS

$T_A = -40^{\circ}\text{C}$  to  $+175^{\circ}\text{C}$ ,  $V_S = 5\text{ V}$ ,  $C_X = 0.1\ \mu\text{F}$ , acceleration =  $0\text{ g}$ , unless otherwise noted.<sup>1</sup>

Table 1.

Parameter	Test Conditions/Comments	Min	Typ	Max	Unit
SENSOR INPUT	Each axis				
Measurement Range <sup>2</sup>		$\pm 5$			$g$
Nonlinearity			$\pm 0.2$		% FS
Package Alignment Error			$\pm 1$		Degrees
Alignment Error	X sensor to Y sensor		$\pm 0.1$		Degrees
Cross-Axis Sensitivity			$\pm 1.5$		%
SENSITIVITY (RATIOMETRIC) <sup>3</sup>					
Sensitivity at $X_{OUT}$ , $Y_{OUT}$	$V_S = 5\text{ V}$	296	312	328	$\text{mV/g}$
Sensitivity Change Due to Temperature <sup>4</sup>	$V_S = 5\text{ V}$		$\pm 0.3$		%
ZERO $g$ BIAS LEVEL (RATIOMETRIC)					
$0\text{ g}$ Voltage at $X_{OUT}$ , $Y_{OUT}$	$V_S = 5\text{ V}$ , $T_A = 25^{\circ}\text{C}$		$2.5 \pm 0.025$		V
$0\text{ g}$ Bias Repeatability	$-40^{\circ}\text{C} \leq T_A \leq +175^{\circ}\text{C}$		$\pm 10$		$\text{mg}$
NOISE PERFORMANCE					
Noise Density	$V_S = 5\text{ V}$ , $T_A = 25^{\circ}\text{C}$		110		$\mu\text{g}/\sqrt{\text{Hz}}$ rms
FREQUENCY RESPONSE <sup>5</sup>					
$C_X$ , $C_Y$ Range <sup>6</sup>		0.002		10	$\mu\text{F}$
$R_{\text{FILT}}$ Tolerance		24	32	40	$\text{k}\Omega$
Sensor Resonant Frequency			5.5		$\text{kHz}$
SELF-TEST <sup>7</sup>					
Logic Input Low				1	V
Logic Input High		4			V
ST Input Resistance to Ground		30	50		$\text{k}\Omega$
Output Change at $X_{OUT}$ , $Y_{OUT}$	ST pin Logic 0 to Logic 1	150	250	350	$\text{mV}$
OUTPUT AMPLIFIER	No load				
Output Swing Low		0.05	0.2		V
Output Swing High			4.5		V
LIFESPAN					
Usable Life Expectancy	$T_A = 175^{\circ}\text{C}$	1000			Hours
POWER SUPPLY					
Operating Voltage Range		4.75		5.25	V
Supply Current			0.7	1.5	$\text{mA}$
Turn-On Time <sup>8</sup>			20		$\text{ms}$

<sup>1</sup> Minimum and maximum specifications are guaranteed. Typical specifications are not guaranteed.

<sup>2</sup> Guaranteed by measurement of initial offset and sensitivity.

<sup>3</sup> Sensitivity is essentially ratiometric to  $V_S$ .

<sup>4</sup> Defined as the output change from ambient temperature to maximum temperature or from ambient temperature to minimum temperature.

<sup>5</sup> Actual frequency response controlled by user-supplied external capacitors ( $C_X$ ,  $C_Y$ ).

<sup>6</sup> Bandwidth =  $1/(2 \times \pi \times 32\text{ k}\Omega \times C)$ . For  $C_X$ ,  $C_Y = 0.002\ \mu\text{F}$ , bandwidth = 2500 Hz. For  $C_X$ ,  $C_Y = 10\ \mu\text{F}$ , bandwidth = 0.5 Hz. Minimum/maximum values are not tested.

<sup>7</sup> Self-test response changes cubically with  $V_S$ .

<sup>8</sup> Larger values of  $C_X$ ,  $C_Y$  increase turn-on time. Turn-on time is approximately  $160 \times C_X$  or  $C_Y + 4\text{ ms}$ , where  $C_X$  and  $C_Y$  are in microfarads ( $\mu\text{F}$ ).

# ABSOLUTE MAXIMUM RATINGS

Table 2.

Parameter	Rating
Acceleration (Any Axis)	
Unpowered	500 g
Powered	500 g
$V_S$	-0.3 V to +7.0 V
All Other Pins	(COM - 0.3 V) to ( $V_S + 0.3 V$ )
Output Short-Circuit Duration (Any Pin to Common)	Indefinite
Ambient Operating Temperature Range ( $T_A$ )	-55°C to +175°C
Storage Temperature Range	-65°C to +200°C

Stresses at or above those listed under Absolute Maximum Ratings may cause permanent damage to the product. This is a stress rating only; functional operation of the product at these or any other conditions above those indicated in the operational section of this specification is not implied. Operation beyond the maximum operating conditions for extended periods may affect product reliability.

## THERMAL RESISTANCE

$\theta_{JA}$  is specified for the worst-case conditions, that is, for a device soldered in a printed circuit board (PCB) for surface-mount packages.

Table 3. Thermal Resistance

Package Type	$\theta_{JA}$	$\theta_{JC}$	Unit
8-Lead SBDIP	120	20	°C/W

## ESD CAUTION



**ESD (electrostatic discharge) sensitive device.** Charged devices and circuit boards can discharge without detection. Although this product features patented or proprietary protection circuitry, damage may occur on devices subjected to high energy ESD. Therefore, proper ESD precautions should be taken to avoid performance degradation or loss of functionality.

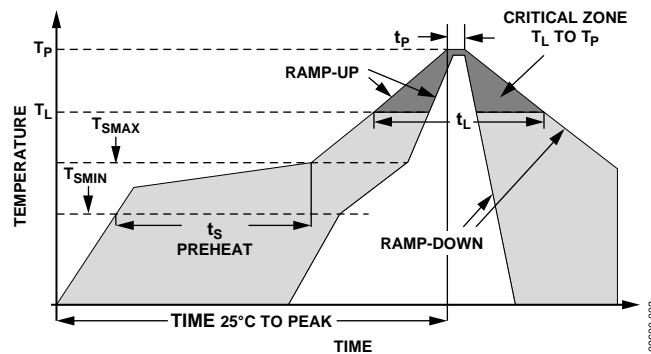

Figure 2. Recommended Soldering Profile

Table 4. Recommended Soldering Profile Limits

Profile Feature	Sn63/Pb37	Pb-Free
Average Ramp Rate ( $T_L$ to $T_P$ )	3°C/sec max	3°C/sec max
Preheat		
Minimum Temperature ( $T_{SMIN}$ )	100°C	150°C
Maximum Temperature ( $T_{SMAX}$ )	150°C	200°C
Time ( $T_{SMIN}$ to $T_{SMAX}$ ), $t_s$	60 sec to 120 sec	60 sec to 150 sec
Ramp-Up Rate ( $T_{SMAX}$ to $T_L$ )	3°C/sec max	3°C/sec max
Time Maintained Above Liquidous ( $t_L$ )	60 sec to 150 sec	60 sec to 150 sec
Liquidous Temperature ( $T_L$ )	183°C	217°C
Peak Temperature ( $T_P$ )	240°C + 0°C/-5°C	260°C + 0°C/-5°C
Time Within 5°C of Actual Peak Temperature ( $t_p$ )	10 sec to 30 sec	20 sec to 40 sec
Ramp-Down Rate ( $T_P$ to $T_L$ )	6°C/sec max	6°C/sec max
Time 25°C to Peak Temperature	6 minutes max	8 minutes max

## PIN CONFIGURATION AND FUNCTION DESCRIPTIONS

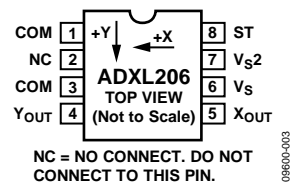

Figure 3. Pin Configuration

Table 5. Pin Function Descriptions

Pin No.	Mnemonic	Description
1, 3	COM	Common.
2	NC	No Connect. Do not connect to this pin.
4	Y <sub>OUT</sub>	Y Channel Output.
5	X <sub>OUT</sub>	X Channel Output.
6	V <sub>s</sub>	Supply.
7	V <sub>s2</sub>	Supply. Must be connected to V <sub>s</sub> .
8	ST	Self-Test.

# TYPICAL PERFORMANCE CHARACTERISTICS

$V_s = 5\text{ V}$ , unless otherwise noted.

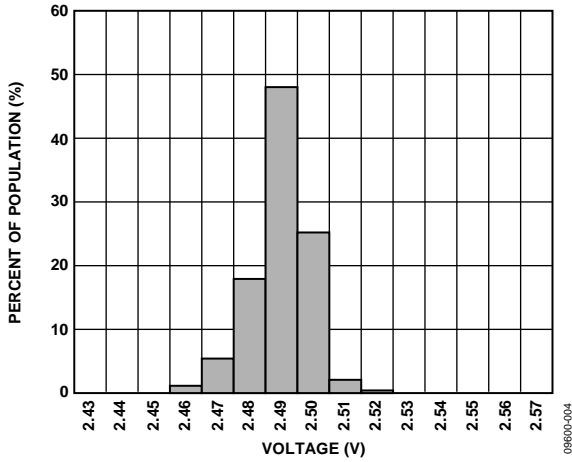

Figure 4. X-Axis Zero g Bias at  $T_A = 25^\circ\text{C}$

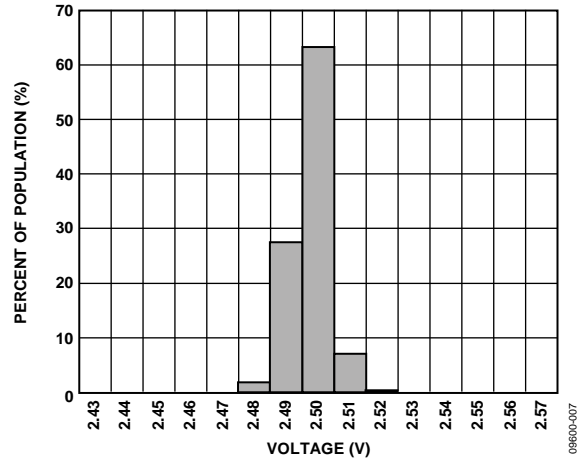

Figure 7. Y-Axis Zero g Bias at  $T_A = 25^\circ\text{C}$

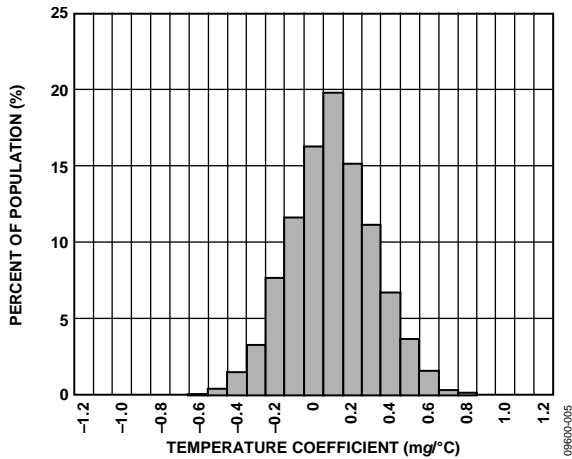

Figure 5. X-Axis Zero g Bias Temperature Coefficient

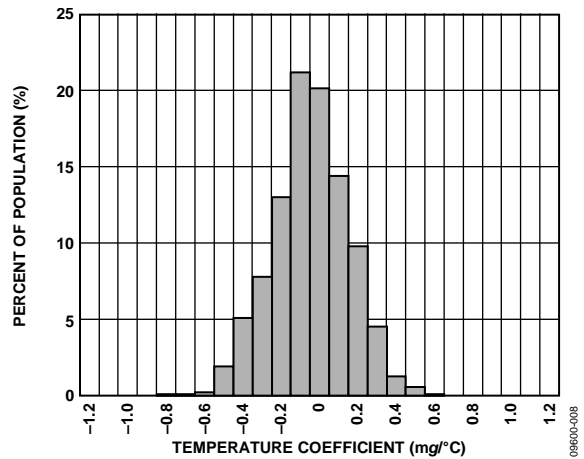

Figure 8. Y-Axis Zero g Bias Temperature Coefficient

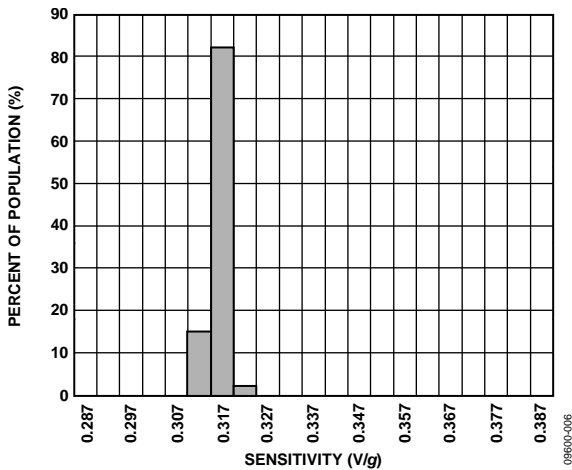

Figure 6. X-Axis Sensitivity at  $T_A = 25^\circ\text{C}$

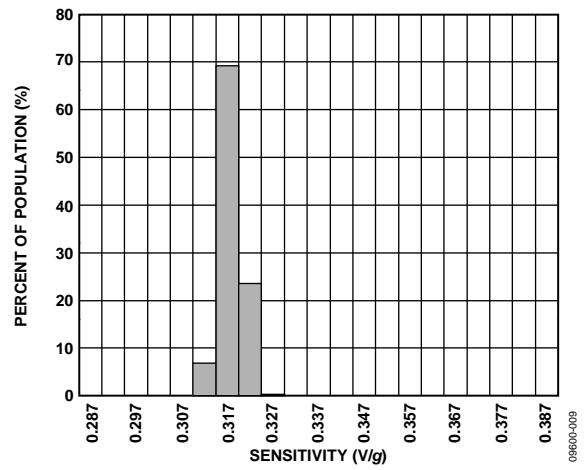

Figure 9. Y-Axis Sensitivity at  $T_A = 25^\circ\text{C}$

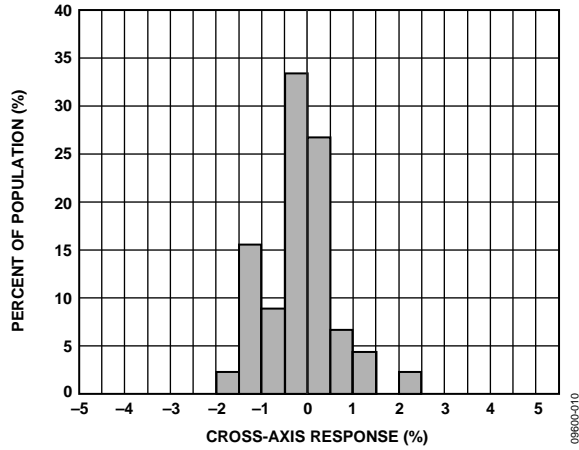

Figure 10. Cross-Axis Response, Z-Axis vs. X-Axis

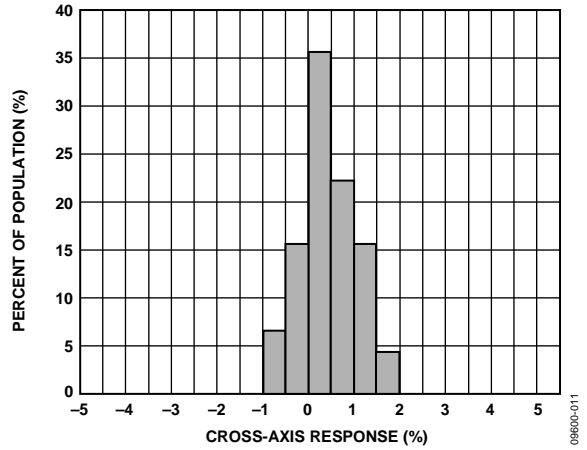

Figure 13. Cross-Axis Response, Z-Axis vs. Y-Axis

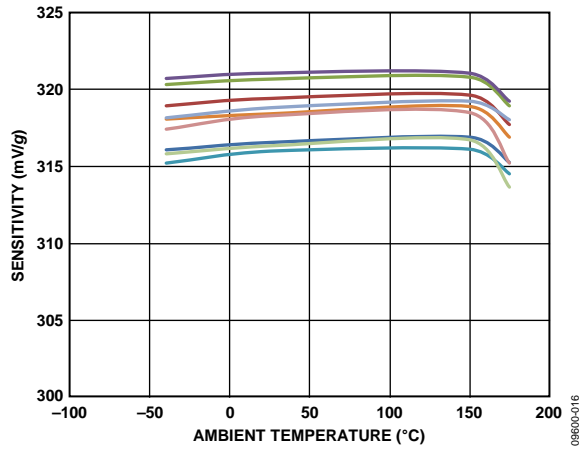

Figure 11. X-Axis Sensitivity over Temperature, Nine Devices

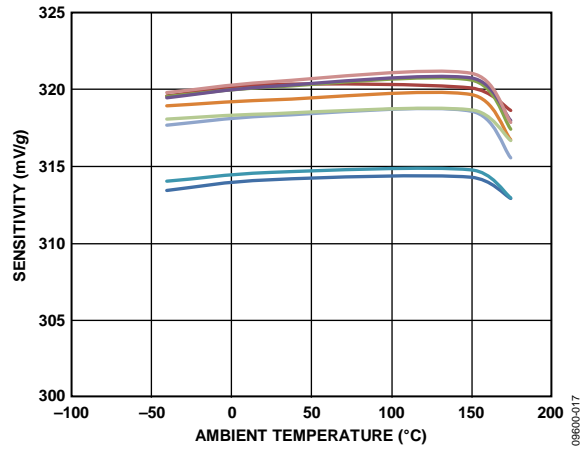

Figure 14. Y-Axis Sensitivity over Temperature, Nine Devices

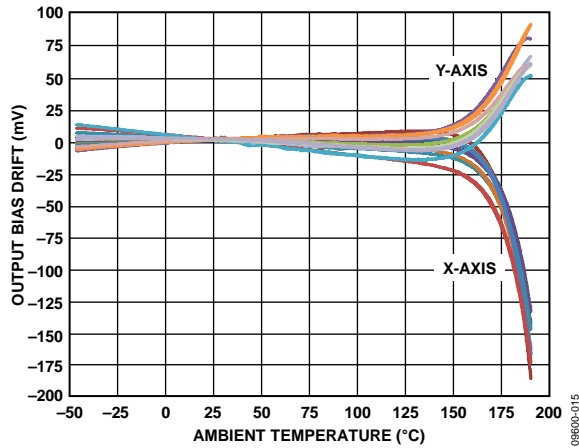

Figure 12. Zero g Output Bias Drift over Temperature, Eight Devices

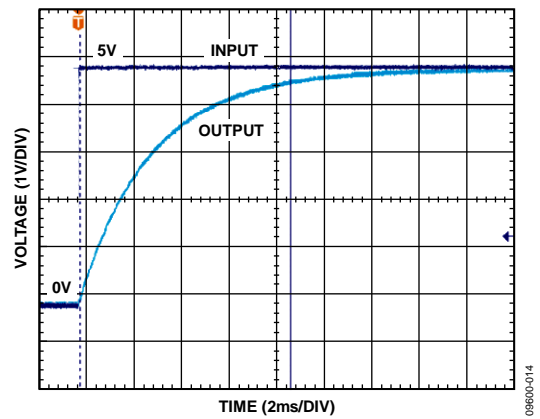

Figure 15. Turn-On Time,  $C_x, C_y = 0.1 \mu F$ , Time Scale = 2 ms/div

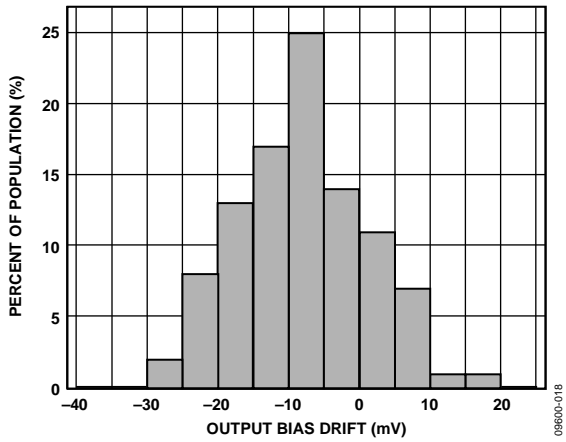

Figure 16. X-Axis Zero g Output Bias Drift over 1000 Hours at  $T_A = 175^\circ\text{C}$ , Powered

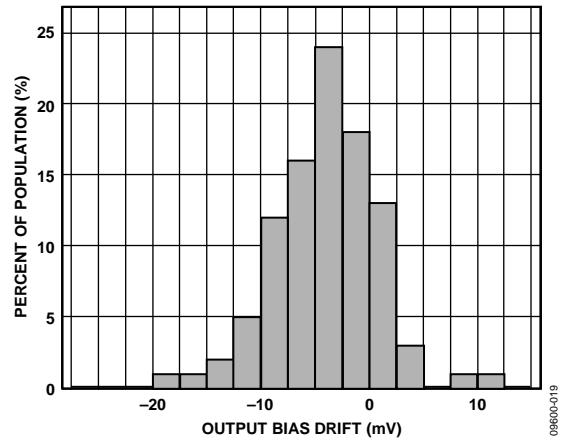

Figure 18. Y-Axis Zero g Output Bias Drift over 1000 Hours at  $T_A = 175^\circ\text{C}$ , Powered

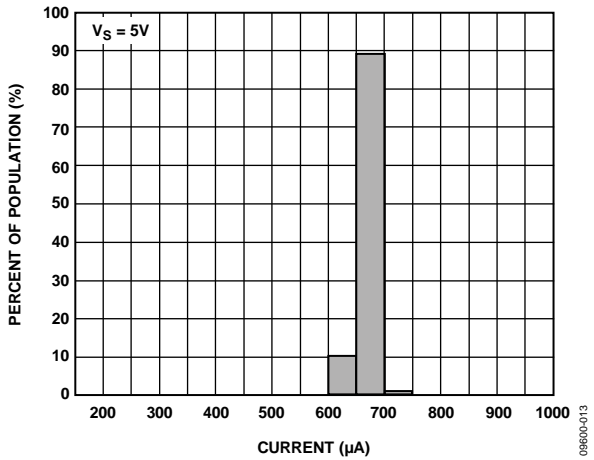

Figure 17. Supply Current at  $T_A = 25^\circ\text{C}$

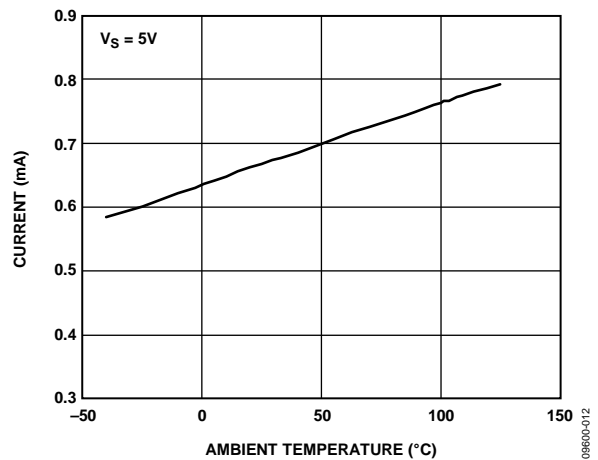

Figure 19. Supply Current vs. Temperature



## THEORY OF OPERATION

The [ADXL206](#) is a complete acceleration measurement system on a single, monolithic IC. The part contains a polysilicon, surface-micromachined sensor and signal conditioning circuitry to implement an open-loop acceleration measurement architecture. The output signals are analog voltages proportional to acceleration. The [ADXL206](#) is capable of measuring both positive and negative accelerations to at least  $\pm 5$  g. The accelerometer can measure static acceleration forces such as gravity, allowing it to be used as a tilt sensor.

The sensor is a surface-micromachined, polysilicon structure built on top of the silicon wafer. Polysilicon springs suspend the structure over the surface of the wafer and provide resistance against acceleration forces. Deflection of the structure is measured using a differential capacitor that consists of independent fixed plates and plates attached to the moving mass. The fixed plates are driven by  $180^\circ$  out-of-phase square waves. Acceleration deflects the beam and unbalances the differential capacitor, resulting in an output square wave whose amplitude is proportional to acceleration. Phase-sensitive demodulation techniques are then used to rectify the signal and determine the direction of the acceleration.

The output of the demodulator is amplified and brought off chip through a  $32\text{ k}\Omega$  resistor. At this point, the user can set the signal bandwidth of the device by adding a capacitor. This filtering improves measurement resolution and helps prevent aliasing.

## PERFORMANCE

Rather than using additional temperature compensation circuitry, innovative design techniques have been used to ensure that high performance is built in. As a result, there is essentially no quantization error or nonmonotonic behavior, and temperature hysteresis is very low (typically less than 2 mg over the  $-40^\circ\text{C}$  to  $+175^\circ\text{C}$  temperature range).

Figure 12 shows the 0 g output performance of eight parts over the  $-40^\circ\text{C}$  to  $+175^\circ\text{C}$  temperature range.

Figure 11 and Figure 14 show the typical sensitivity shift over temperature for  $V_s = 5$  V. Sensitivity stability is optimized for  $V_s = 5$  V, but it is very good over the full supply voltage range.

## APPLICATIONS INFORMATION

### POWER SUPPLY DECOUPLING

For most applications, a single 0.1  $\mu\text{F}$  capacitor,  $C_{\text{DC}}$ , adequately decouples the accelerometer from noise on the power supply. In some cases, however, particularly where noise is present at the 140 kHz internal clock frequency (or any harmonic thereof), noise on the supply can cause interference on the [ADXL206](#) output. If additional decoupling is needed, a 100  $\Omega$  (or smaller) resistor or ferrite bead can be inserted in the supply line of the [ADXL206](#). Additionally, a larger bulk bypass capacitor (in the 1  $\mu\text{F}$  to 22  $\mu\text{F}$  range) can be added in parallel to  $C_{\text{DC}}$ .

### SETTING THE BANDWIDTH USING $C_X$ AND $C_Y$

The [ADXL206](#) has provisions for band-limiting the  $X_{\text{OUT}}$  and  $Y_{\text{OUT}}$  pins. A capacitor must be added to the pin to implement low-pass filtering for antialiasing and noise reduction. The equation for the 3 dB bandwidth is

$$f_{-3\text{ dB}} = 1/(2\pi(32\text{ k}\Omega) \times C_x)$$

or more simply,

$$f_{-3\text{ dB}} = 5\ \mu\text{F}/C_x$$

The tolerance of the internal resistor ( $R_{\text{FILT}}$ ) can vary typically as much as  $\pm 25\%$  of its nominal value (32 k $\Omega$ ); thus, the bandwidth varies accordingly. A minimum capacitance of 2000 pF for  $C_X$  and  $C_Y$  is required in all cases.

**Table 6. Filter Capacitor Selection,  $C_X$  and  $C_Y$**

Bandwidth (Hz)	Capacitor ( $\mu\text{F}$ )
1	4.7
10	0.47
50	0.10
100	0.05
200	0.027
500	0.01

### SELF-TEST

The ST pin controls the self-test feature. When this pin is set to  $V_S$ , an electrostatic force is exerted on the beam of the accelerometer. The resulting movement of the beam allows the user to test whether the accelerometer is functional. The typical change in output is 800 mg (corresponding to 250 mV). This pin can be left open-circuit or connected to common in normal use.

The ST pin should never be exposed to voltage greater than  $V_S + 0.3\text{ V}$ . If the system design is such that this condition cannot be guaranteed (that is, multiple supply voltages are present), it is recommended that a clamping diode with low forward voltage be connected between ST and  $V_S$ .

### DESIGN TRADE-OFFS FOR SELECTING FILTER CHARACTERISTICS: NOISE/BANDWIDTH TRADE-OFF

The accelerometer bandwidth selected ultimately determines the measurement resolution (smallest detectable acceleration). Filtering can be used to lower the noise floor, improving the resolution of the accelerometer. Resolution is dependent on the analog filter bandwidth at  $X_{\text{OUT}}$ .

The output of the [ADXL206](#) has a typical bandwidth of 2.5 kHz. The user must filter the signal at this point to limit aliasing errors. The analog bandwidth must be no more than half the analog-to-digital sampling frequency to minimize aliasing. The analog bandwidth can be further decreased to reduce noise and improve resolution.

The [ADXL206](#) noise has the characteristics of white Gaussian noise, which contributes equally at all frequencies and is described in terms of  $\mu\text{g}/\sqrt{\text{Hz}}$  (that is, the noise is proportional to the square root of the accelerometer bandwidth). The user should limit bandwidth to the lowest frequency needed by the application to maximize the resolution and dynamic range of the accelerometer.

With the single-pole roll-off characteristic, the typical noise of the [ADXL206](#) is determined by

$$\text{rms Noise} = (110\ \mu\text{g}/\sqrt{\text{Hz}}) \times (\sqrt{BW} \times 1.6)$$

At 100 Hz, the noise is

$$\text{rms Noise} = (110\ \mu\text{g}/\sqrt{\text{Hz}}) \times (\sqrt{100} \times 1.6) = 1.4\ \text{mg}$$

Often, the peak value of the noise is desired. Peak-to-peak noise can only be estimated by statistical methods. Table 7 is useful for estimating the probability of exceeding various peak values, given the rms value.

**Table 7. Estimation of Peak-to-Peak Noise**

Peak-to-Peak Value	% of Time That Noise Exceeds Nominal Peak-to-Peak Value
2 $\times$ rms	32
4 $\times$ rms	4.6
6 $\times$ rms	0.27
8 $\times$ rms	0.006

Peak-to-peak noise values give the best estimate of the uncertainty in a single measurement; peak-to-peak noise is estimated by 6  $\times$  rms. Table 8 gives the typical noise output of the [ADXL206](#) for various  $C_X$  and  $C_Y$  values.

**Table 8. Typical Noise Output for Various Capacitor Values**

Bandwidth (Hz)	$C_X, C_Y$ ( $\mu\text{F}$ )	RMS Noise (mg)	Peak-to-Peak Noise Estimate (mg)
10	0.47	0.4	2.6
50	0.1	1.0	6
100	0.047	1.4	8.4
500	0.01	3.1	18.7

### USING THE ADXL206 WITH OPERATING VOLTAGES OTHER THAN 5 V

The ADXL206 is tested and specified at  $V_s = 5$  V; however, it can be powered with  $V_s$  as low as 3 V or as high as 6 V. Some performance parameters change as the supply voltage is varied.

The ADXL206 output is ratiometric; therefore, the output sensitivity (or scale factor) varies proportionally to the supply voltage. The zero  $g$  bias output is also ratiometric; therefore, the zero  $g$  output is nominally equal to  $V_s/2$  at all supply voltages.

The output noise is not ratiometric but is absolute in volts; therefore, the noise density decreases as the supply voltage increases.

Self-test response in  $g$  is roughly proportional to the square of the supply voltage. However, when ratiometricity of sensitivity is factored in with supply voltage, self-test response in volts is roughly proportional to the cube of the supply voltage. Therefore, at  $V_s = 3$  V, the typical self-test response is approximately 50 mV or about 160 mg.

### USING THE ADXL206 AS A DUAL-AXIS TILT SENSOR

One of the most popular applications of the ADXL206 is tilt measurement. An accelerometer uses the force of gravity as an input vector to determine the orientation of an object in space.

An accelerometer is most sensitive to tilt when its sensitive axis is perpendicular to the force of gravity, that is, parallel to the earth's surface. At this orientation, the sensitivity of the accelerometer to changes in tilt is highest. When the axis of sensitivity is parallel to gravity, that is, near its  $+1 g$  or  $-1 g$  reading, the change in output acceleration per degree of tilt is negligible. When the accelerometer is perpendicular to gravity, its output changes nearly 17.5 mg per degree of tilt. At  $45^\circ$ , its output changes at only 12.2 mg per degree and resolution declines.

#### **Dual-Axis Tilt Sensor: Converting Acceleration to Tilt**

When the accelerometer is oriented so that both its x-axis and y-axis are parallel to the earth's surface, it can be used as a 2-axis tilt sensor with a roll axis and a pitch axis. After the output signal from the accelerometer is converted to an acceleration that varies between  $-1 g$  and  $+1 g$ , the output tilt in degrees is calculated as follows:

$$PITCH = \arcsin(A_x/1 g)$$

$$ROLL = \arcsin(A_y/1 g)$$

Make sure to account for overranges. It is possible for the accelerometer to output a signal greater than  $\pm 1 g$  due to vibration, shock, or other accelerations.

OUTLINE DIMENSIONS

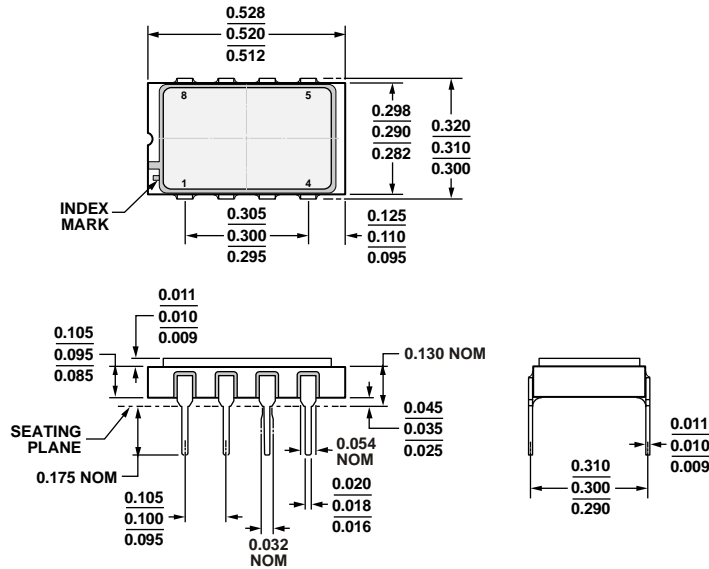

Figure 20. 8-Lead Side-Brazed Ceramic Dual In-Line Package [SBDIP] (D-8-1)  
Dimensions shown in inches

ORDERING GUIDE

Model <sup>1,2</sup>	Number of Axes	Specified Voltage (V)	Temperature Range	Package Description	Package Option
ADXL206HDZ	2	5	-40°C to +175°C	8-Lead SBDIP	D-8-1

<sup>1</sup> Lead finish. Gold over nickel over tungsten.  
<sup>2</sup> Z = RoHS Compliant Part.