

**General Description**

The MAX77756 evaluation kit (EV kit) is a fully assembled and tested PCB that demonstrates the MAX77756 synchronous 500mA step-down converter. The EV kit allows for easy evaluation of the IC’s input power multiplexer and step-down converter. A dual-range (8mA and 800mA full scale) electronic load is included on the EV kit for easy buck converter load control.

Windows®-based software provides a user-friendly graphical user interface (GUI), as well as a detailed register-based interface to exercise the features of the IC.

Ordering Information appears at end of data sheet.

**Benefits and Features**

- Easy to Use
  - Evaluates Both Fixed-Output and Adjustable-Output Versions (3.3V Version Preinstalled)
  - 3V to 24V Input Voltage Range
  - Demonstrates 1.5µA Quiescent Current at 12V<sub>SUP</sub> Input
- GUI Drives I<sup>2</sup>C Interface
- Emulates System Loading
  - On-Board Electronic Load
  - Electronic Load has Steady-State, Transient, and Random Modes
  - Optional Ability to Control Electronic Load through Function Generator for Patterned Load Waveforms
- Proven PCB Layout
- Fully Assembled and Tested

**MAX77756 EV Kit Photo**

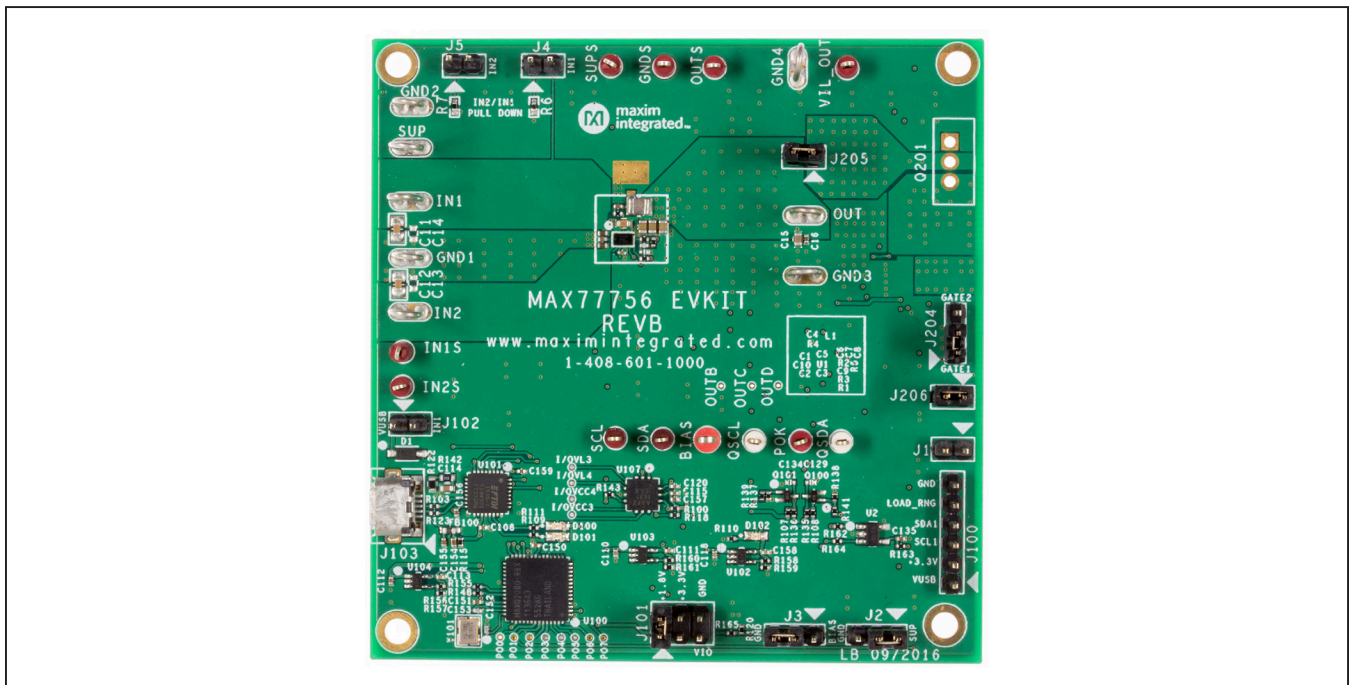

Windows is a registered trademark and registered service mark of Microsoft Corporation.



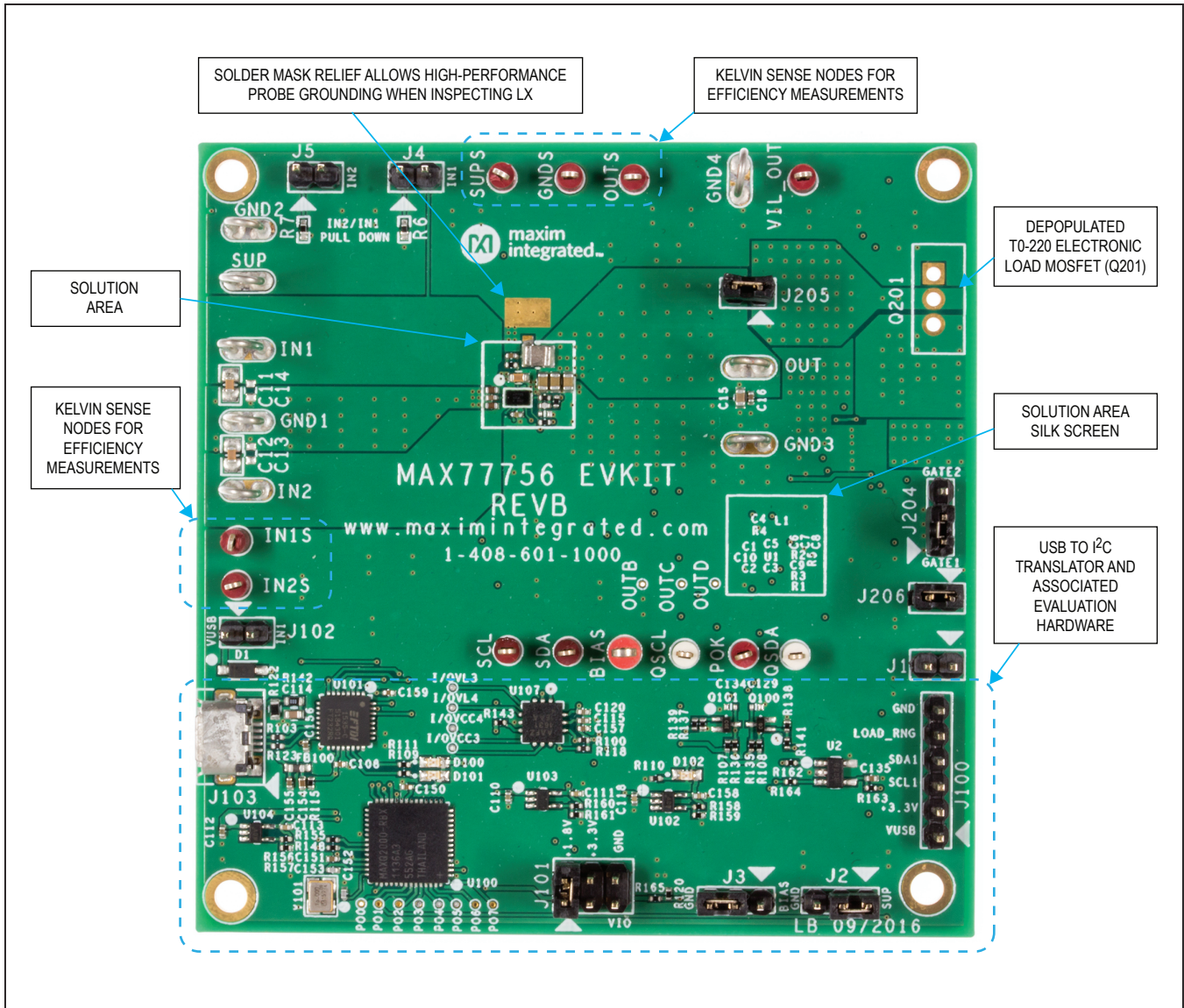

Figure 1. MAX77756 EV Kit PCB—Top View with Default Shunt Positions



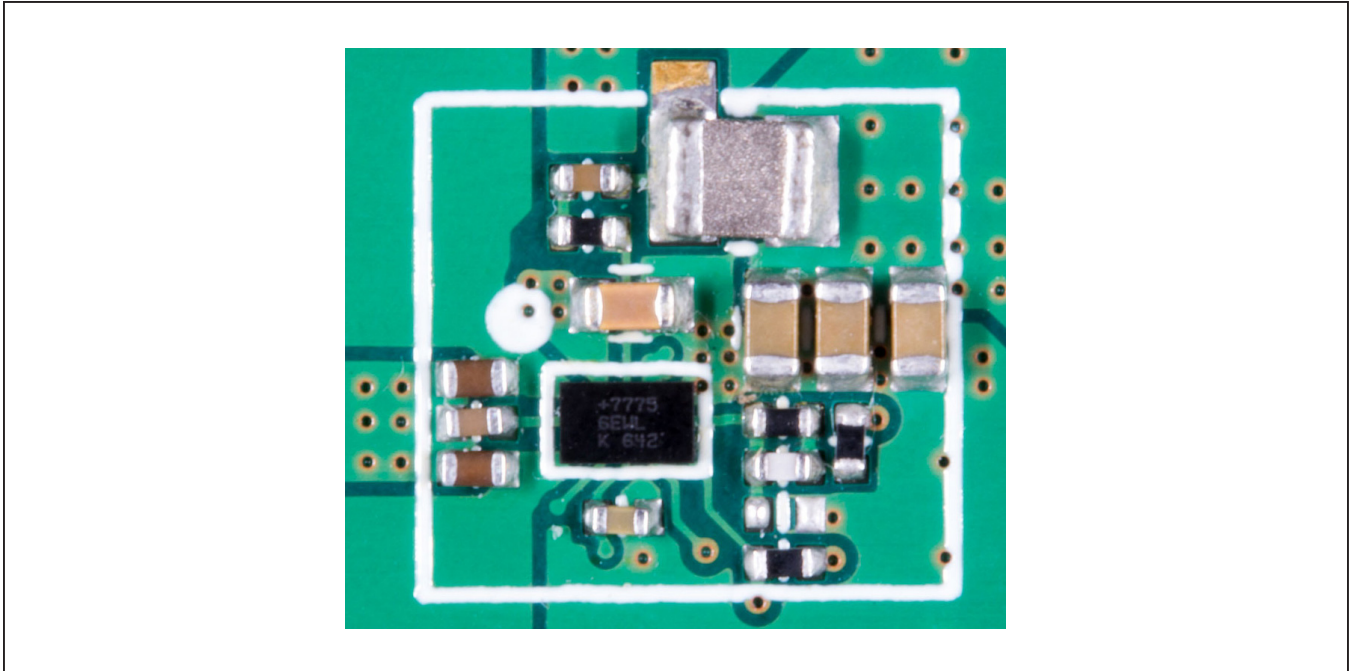

Figure 3. MAX77756 EV Kit PCB—Top View Solution Area

## Quick Start

### Required Equipment

- MAX77756 EV kit
- Windows-based PC
- Power supply
- Ammeter
- Digital voltmeter (DVM)
- Micro-USB cable

**Note:** In the following sections, software-related items are identified by bolding. Text in **bold** refers to items directly from the EV kit software.

### Procedure

The EV kit is fully assembled and tested. Follow the steps below to verify board operation:

- 1) Visit [www.maximintegrated.com/evkitsoftware](http://www.maximintegrated.com/evkitsoftware) to download and install the latest version of the EV kit GUI software. Save the EV kit software to your local MAX77756 folder and uncompress the ZIP file. Run the .EXE file that was uncompressed and follow the on-screen instructions to complete installation.
- 2) Install the EV kit shunts per [Table 1](#).
- 3) Apply a power supply set to 0V (100mA current limit) through an ammeter (10mA range) across the SUP and GND2 terminals of the EV kit. Turn the supply on and increase the voltage to 12V. To avoid excessive in-rush current into the input capacitors of the EV kit, do not connect a precharged power supply to the input. See the [Input Slew-Rate Limiting](#) section for more information.
- 4) Connect a Micro-B USB cable between the EV kit's J103 and your Windows-based PC.
- 5) Open the GUI and press the **Device** button in the menu bar. Press the **Connect** button in the **Device** button's drop-down list. Wait for the device to respond, and in the **Synchronize** window, press the **Read and close** button.
- 6) Confirm with the ammeter that the quiescent current is approximately 1.5μA.
- 7) Confirm with DVM that output voltage is 3.3V.

This concludes the *Quick Start* procedure. Users are encouraged to explore the device and its register settings with the GUI. During general device evaluation, set the ammeter range to  $\geq 1A$  to minimize the impact of its series resistance. For more information on the GUI, see the [Detailed Description of Software](#) section.

**Table 1. Default Shunt Positions and Jumper Descriptions**

JUMPER	SHUNT POSITION	FUNCTION
J1	1-2	Connects POK to BIAS through a 100kΩ resistor.
	Open*	Disconnects POK from BIAS.
J2	1-2*	Connects EN to SUP.
	2-3	Connects EN to GND.
J3	1-2*	Connects ILIM to BIAS.
	2-3	Connects ILIM to GND.
J4	1-2	Connects IN1 to GND through a 100kΩ resistor.
	Open*	Disconnects IN1 from GND.
J5	1-2	Connects IN2 to GND through a 100kΩ resistor.
	Open*	Disconnects IN2 from GND.
J100	Open*	J100 is an evaluation header. Do not connect shunts to J100.
J101	1-2*	Connects VIO to the 1.8V EV kit logic rail.
	3-4	Connects VIO to the 3.3V EV kit logic rail.
	5-6	Connects VIO to GND.
J102	1-2	Connects VUSB to IN1 through a Schottky diode, D1. Install this jumper to power the MAX77756 IN1 from VUSB. This jumper allows for communication with the MAX77756 through the on-board USB-to-I <sup>2</sup> C translator without the need for an external power supply. <b>Note:</b> Remove this jumper any time an external power supply is applied as an input source.
	Open*	Disconnects VUSB from IN1.
J204	1-2*	Connects the U202 amplifier to the gate of the Q202 load MOSFET.
	2-3	Connects the U202 amplifier to the gate of the Q201 depopulated TO-220 electronic load MOSFET.
J205	1-2*	Connects OUT to the on-board electronic load.
J206	1-2*	Connects the DAC output to the on-board load's error amplifier U202.

\*Default position.

### Detailed Description of Software

The GUI software allows for quick, easy, and thorough evaluation of the MAX77756 IC. The GUI is designed to present all the controls necessary to operate the IC and on-board electronic load circuit. See [Figure 4](#) for a screenshot of the GUI upon first opening.

### Installation

Visit [www.maximintegrated.com/evkitsoftware](http://www.maximintegrated.com/evkitsoftware) to download and install the latest version of the EV kit GUI software. Save the EV kit software to your local MAX77756 folder and uncompress the ZIP file. Right-click on the .EXE file that was uncompressed and select “Run as Administrator.” Follow the on-screen instructions to complete the installation.

### Windows Drivers

After connecting a Micro-USB cable between your PC and the EV kit for the first time, wait a few minutes for Windows to automatically install the necessary drivers.

### Graphical User Interface (GUI) Details

The GUI drives I<sup>2</sup>C communication with the EV kit. Two control tabs are available.

The **BUCK** tab controls correspond directly to bitfields within the IC. Hovering your pointer over the control text

descriptions results in a pop-up window indicating the exact bitfield for that control. Refer to the MAX77756 IC data sheet’s *Register Map* section for complete bitfield descriptions.

The **Load Control** tab controls the on-board electronic load, which is provided to make evaluation more convenient. None of the controls on the **Load Control** tab manipulate bitfields within the IC.

### Evaluating Other MAX77756 Versions

The EV kit natively supports the 3.3V internal-feedback version of the IC. The EV kit is designed so that any version of the IC can be evaluated with the same hardware. To evaluate the 1.8V or 5V internal-feedback versions of the IC, replace the U1 component on the EV kit with the desired output version (refer to the data sheet’s [Ordering Information](#)). No other component changes are required to evaluate the internal-feedback version.

To evaluate the external resistor-divider feedback version of the IC, replace the U1 component on the EV kit with the MAX77756D. The external feedback resistors (R2 and R3) must be adjusted according to the *Setting the Output Voltage (MAX77756D)* section in the MAX77756 IC data sheet.

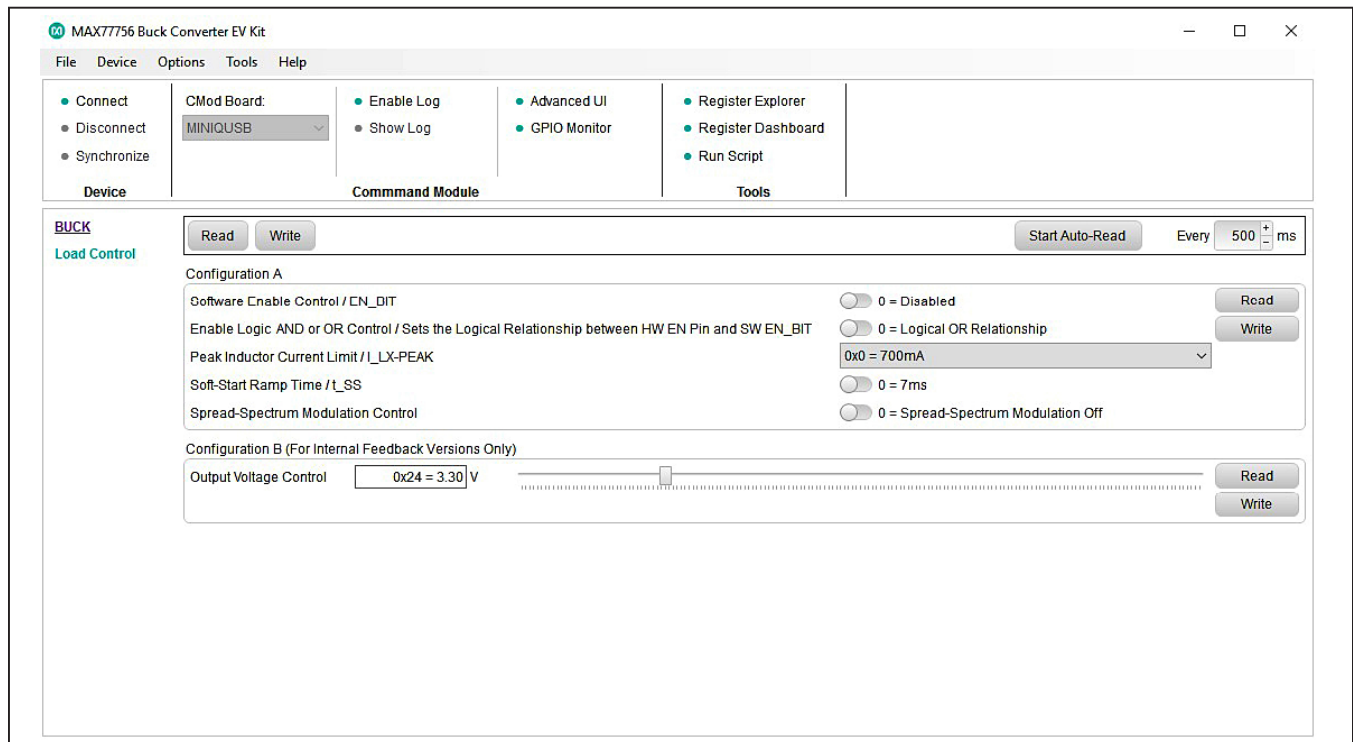

Figure 4. MAX77756 EV Kit Top-Level Interface GUI Screenshot

## Detailed Description of Hardware

### Hardware Considerations

#### Input Slew-Rate Limiting

The forward current from IN1 or IN2 to SUP must be limited to less than 4.1A according to the absolute maximum ratings of the device (see the MAX77756 IC data sheet's *Absolute Maximum Ratings* section). To ensure compliance with this, a design must limit the supply voltage slew rate to IN1 or IN2, and/or the value of the SUP capacitor ( $I_{INx} = C_{SUP} \times dV/dt$ ). Never "hot-plug" a precharged voltage supply to IN1 or IN2. The voltage slew rate of a hot-plug event is very fast and can cause inrush currents in excess of 4.1A.

To avoid a hot-plug event, set any input power supply to 0V, connect the supply to the EV kit, enable the output, and increase the voltage to the desired value. For battery insertion into IN1 or IN2, precharge SUP to the battery voltage before connecting the battery to IN1 or IN2. This prevents any inrush current pass from IN1 or IN2 to the SUP capacitor.

#### High-Performance LX Probing

The step-down converter's LX node has fast rising and falling voltage edges (a few nanoseconds). It is difficult to get a clean and noise-free measurement of the LX node voltage using traditional oscilloscope voltage-probing techniques due to the length of the oscilloscope probe ground lead. The EV kit has exposed areas of copper near the LX node that allow for low-noise probing. To properly probe the LX node:

- 1) Remove the oscilloscope probe covers to expose the bare probe tip and ground sleeve.
- 2) Wrap a piece of bare solid wire several times around the ground sleeve of the probe and bend the end of the wire close to the oscilloscope probe tip.
- 3) Cut off the wire so it reaches the same length as the oscilloscope probe tip. This wire acts as the ground connection for the probe.
- 4) Place the tip of the oscilloscope probe on the bare copper connected to the inductor (L1) and place the ground lead on the exposed copper ground pad above L1, as shown in [Figure 5](#).

#### Electronic Load

An on-board electronic load is provided to make evaluation more convenient. The electronic load controls are available through the **Load Control** tab of the GUI. Three modes of operation are available: steady-state, transient, and random. To configure the electronic load, use the slider bar or enter a current value (mA) into the text field and click the **Enable** button. Experiment with different electronic-load operating modes to gain insight to how the device performs under various conditions.

For the transient and random modes of operation, the "target time-slice" values are simply targets. The evaluation system does not use a real-time operating system so variations in that time are normal. If an older computer appears to run slow with the GUI, try to use longer values for the "target time slice."

The offset and gain values are set by Maxim and do not need to be altered.

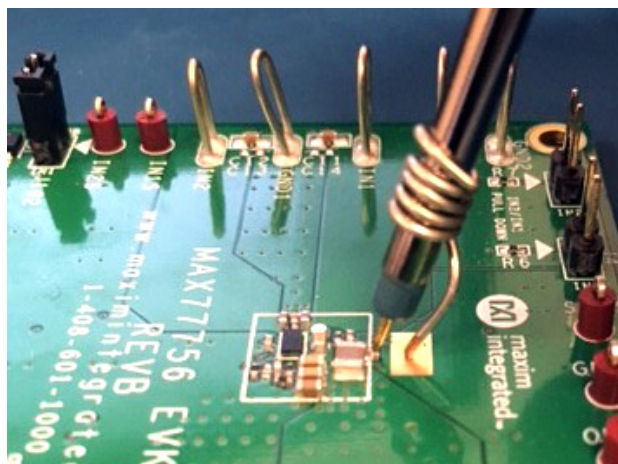

Figure 5. High-Performance LX Probing Technique

**Electronic-Load Transistor**

The on-board electronic-load circuit uses a D-Pack MOSFET (Q202) by default to control the load current. This transistor uses the copper of the EV kit’s PCB as a heatsink. When operating the load at the IC’s maximum output capacity, the load transistor produces a lot of heat and spreads the heat through the EV kit board. If this self-heating effect is undesirable, install a TO-220 MOSFET with an attached heatsink in position Q201 to spread the heat out to an external heatsink. Move the shunt on jumper J204 to the 2-3 position after installing the TO-220 MOSFET to change the gate-drive signal to the proper MOSFET.

**High-Speed Load-Transient Generation**

The on-board electronic-load circuit is designed to generate very high-speed load transients. To create high-speed load transients:

- 1) Connect a Micro-B USB cable between the EV kit’s J103 and a computer or USB wall adapter. This cable allows the load to enter the 800mA range (default range).
- 2) Connect an input power supply of desired voltage to the IC to IN1, IN2, or SUP, as described in the [Input Slew-Rate Limiting](#) section.

- 3) Enable the IC by installing a shunt on J2 in the 1-2 position.
- 4) Remove the shunt on J204.
- 5) Connect a function generator between pin 1 of jumper J104 (Q202’s gate pin) and GND3.
- 6) Connect an oscilloscope to the VIL\_OUT test point. This test point senses the voltage on the electronic-load circuit’s 500mΩ sense resistor. A voltage of 100mV on this node is equivalent to 200mA of load current while the electronic load is in the 800mA range.
- 7) Configure the function generator to create a pulse waveform of desired period and pulse width. Set the low level of the pulse to 0V and the high level of the pulse to 1V. 1V is below the threshold voltage of the electronic-load circuit’s MOSFET and does not create an appreciable load current.
- 8) While monitoring the VIL\_OUT voltage on the oscilloscope, slowly increase the high level of the pulse waveform until the desired pulsed load current is achieved.

**Ordering Information**

PART	TYPE
MAX77756EVKIT#	EV Kit

#Denotes RoHS compliant.



MAX77756 EV System Bill of Materials

REF_DES	DNI, DNP	QTY	MFG PART #	MFG	VALUE	DESCRIPTION
BIAS		1	5010	KEystone		TESTPOINT WITH 1.80MM HOLE DIA, RED, MULTIPURPOSE;
C1, C2		2	C1005X5R1E225K050	TDK	2.2UF	CAPACITOR; SMT (0402); CERAMIC CHIP; 2.2UF; 25V; TOL=10%; TG=-55 DEGC TO +85 DEGC; TC=X5R
C3		1			1UF	CAPACITOR; SMT (0402); CERAMIC CHIP; 1UF; 6.3V; TOL=20%; MODEL=C SERIES; TG=-55 DEGC TO +85 DEGC; TC=X5R ; FORMFACTOR
C4, C10		2			0.1UF	CAPACITOR; SMT; 0402; CERAMIC; 0.1uF; 10V; 10%; X5R; -55degC to + 125degC; 0 +/-30PPM/degC; FORMFACTOR ;
C5		1			1UF	CAPACITOR; SMT (0603); CERAMIC CHIP; 1UF; 25V; TOL=10%; MODEL=GRM SERIES; TG=-55 DEGC TO +125 DEGC; TC=X7R; FORMFACTOR
C6-C8		3			22UF	CAPACITOR; SMT (0603); CERAMIC CHIP; 22UF; 10V; TOL=20%; MODEL=CL SERIES; TG=-55 DEGC TO +85 DEGC; TC=X5R; FORMFACTOR
C9		1	GRM1555C1H5R0CZ01D	MURATA	5PF	CAPACITOR; SMT (0402); CERAMIC CHIP; 5PF; 50V; TOL=+-0.25PF; MODEL=C0G; TG=-55 DEGC TO +125 DEGC; TC=+/-
C11, C12		2	08053C105JAT2A	AVX	1UF	CAPACITOR; SMT (0805); CERAMIC CHIP; 1UF; 25V; TOL=5%; MODEL=X7R; TG=-55 DEGC TO +85 DEGC; TC=+/-
C13,C14	Do not install	2			OPEN	CAPACITOR; SMT (0603); OPEN; FORMFACTOR
C15		1			4.7UF	CAPACITOR; SMT (0603); CERAMIC CHIP; 4.7UF; 16V; TOL=10%; MODEL=; TG=-55 DEGC TO +85 DEGC; TC=X5R ; FORMFACTOR
C16		1	GRM155R61C104KA88	MURATA	0.1UF	CAPACITOR; SMT (0402); CERAMIC; 0.1UF; 16V; TOL=10%; MODEL=GRM SERIES; TG=-55 DEGC to +85 DEGC; TC=X5R
C108, C135, C150, C151, C155-C157, C159		8			0.1UF	CAPACITOR; SMT (0402); CERAMIC CHIP; 0.1UF; 50V; TOL=10%; MODEL=CGA SERIES; TG=-55 DEGC TO +125 DEGC; TC=X7R; FORMFACTOR
C110-C113, C115, C118, C120, C158		8			1UF	CAPACITOR; SMT (0402); CERAMIC CHIP; 1UF; 6.3V; TOL=10%; MODEL=; TG=-55 DEGC TO +85 DEGC; TC=X5R;
C114		1			0.47UF	CAPACITOR; SMT; 0603; CERAMIC; 0.47uF; 10V; 10%; X5R; -55degC to + 125degC. ; FORMFACTOR
C129,C134	Do not install	2			OPEN	CAPACITOR; SMT (0402); OPEN; FORMFACTOR
C152, C153		2	C0402C0G500-150JNP; GRM1555C1H150JA01	VENKEL LTD./MURATA	15PF	CAPACITOR; SMT (0402); CERAMIC CHIP; 15PF; 50V; TOL=5%; TG=-55 DEGC TO +125 DEGC; TC=C0G
C154		1			4.7UF	CAPACITOR; SMT (0402); CERAMIC CHIP; 4.7UF; 10V; TOL=20%; MODEL=C SERIES; TG=-55 DEGC TO +85 DEGC; TC=X5R; FORMFACTOR

MAX77756 EV System Bill of Materials (continued)

REF_DES	DNI, DNP	QTY	MFG PART #	MFG	VALUE	DESCRIPTION
C211		1			1000PF	CAPACITOR; SMT (0402); CERAMIC CHIP; 1000PF; 50V; TOL=10%; MODEL=C0G; TG=-55 DEGC TO +125 DEGC; TC=+; FORMFACTOR
C212, C221-C223		4			0.1UF	CAPACITOR; SMT (0402); CERAMIC CHIP; 0.1UF; 25V; TOL=10%; MODEL=C SERIES; TG=-55 DEGC TO +125 DEGC; TC=X7R; FORMFACTOR
C213, C214		2	C0402C101K5GAC; C1005C0G1H101K050BA	KEMET/TDK	100PF	CAPACITOR; SMT; 0402; CERAMIC; 100pF; 50V; 10%; C0G; -55degC to + 125degC; 0 +/-30PPM/degC
C241		1	C1005X5R1C105K	TDK	1UF	CAPACITOR; SMT (0402); CERAMIC CHIP; 1UF; 16V; TOL=10%; MODEL=C SERIES; TG=-55 DEGC TO +85 DEGC; TC=X5R
C250		1	C1005X5R1H472K050	TDK	4700PF	CAPACITOR; SMT (0402); CERAMIC CHIP; 4700PF; 50V; TOL=10%; TG=-55 DEGC TO +85 DEGC; TC=X5R
D1		1	CMHSH5-4	CENTRAL SEMICONDUCTOR CORP.	CMHSH5-4	DIODE; SCH; SMT (SOD-123); PIV=40V; IF=0.5A; -65 DEGC TO +125 DEGC
D100, D101		2	LTST-C190YKT	LITE-ON ELECTRONICS; INC.	LTST-C190YKT	DIODE; LED; STANDARD; YELLOW; SMT (0603); PIV=5.0V; IF=0.02A; -55 DEGC TO +85 DEGC
D102		1	LTST-C190GKT	LITE-ON ELECTRONICS; INC.	LTST-C190GKT	DIODE; LED; WATER CLEAR GREEN; SMT (0603); VF=2.1V; IF=0.03A; -55 DEGC TO +85 DEGC
FB100		1	BLM18PG221SN1	MURATA	220	INDUCTOR; SMT (0603); FERRITE-BEAD; 220; TOL=+/-25%; 1.4A; -55 DEGC TO +125 DEGC
IN1, IN2, OUT, SUP, GND1-GND4		8	9020 BUSS	WEICO WIRE	MAXIMPAD	EVK KIT PARTS; MAXIM PAD; WIRE; NATURAL; SOLID; WEICO WIRE; SOFT DRAWN BUS TYPE-S; 20AWG
POK, SCL, SDA, GNDS, IN1S, IN2S, OUTS, SUPS, VIL_OUT		9	5000	KEYSTONE		TEST POINT; PIN DIA=0.1IN; TOTAL LENGTH=0.3IN; BOARD HOLE=0.04IN; RED; PHOSPHOR BRONZE WIRE SILVER PLATE FINISH;
J1, J4, J5, J102		4	PBC02SAAN	SULLINS ELECTRONICS CORP.	PBC02SAAN	EVKIT PART-CONNECTOR; MALE; THROUGH HOLE; BREAKAWAY; STRAIGHT; 2PINS; -65 DEGC TO +125 DEGC;
J2, J3, J204		3	PEC03SAAN	SULLINS ELECTRONICS CORP.	PEC03SAAN	EVKIT PART-CONNECTOR; MALE; THROUGH HOLE; BREAKAWAY; STRAIGHT; 3PINS; -65 DEGC TO +125 DEGC;
J100		1	PBC06SAAN	SULLINS ELECTRONICS CORP.	PBC06SAAN	CONNECTOR; MALE; THROUGH HOLE; BREAKAWAY; STRAIGHT; 6PINS; -65 DEGC TO +125 DEGC
J101		1	PBC03DAAN	SULLINS ELECTRONICS CORP.	PBC03DAAN	CONNECTOR; MALE; THROUGH HOLE; BREAKAWAY; STRAIGHT; 6PINS; -65 DEGC TO +125 DEGC
J103		1	10103592-0001LF	FCI CONNECT	10103592-0001LF	CONNECTOR; FEMALE; SMT; MICRO USB B-TYPE REVERSE; RIGHT ANGLE; 5PINS

MAX77756 EV System Bill of Materials (continued)

REF_DES	DNI, DNP	QTY	MFG PART #	MFG	VALUE	DESCRIPTION
J205, J206		2	TSW-102-07-T-S	SAMTEC	TSW-102-07-T-S	CONNECTOR; THROUGH HOLE; TSW SERIES; SINGLE ROW; STRAIGHT; 2PINS; -55 DEGC TO +105 DEGC
L1		1	1239AS-H-100N=P2	TOKO	10UH	INDUCTOR; SMT (2520); METAL ALLOY CHIP; 10UH; TOL=+/-30%; 0.85A; FORMFACTOR
Q100, Q101		2	FDY300NZ	FAIRCHILD SEMICONDUCTOR	FDY300NZ	TRAN; SINGLE N-CHANNEL 2.5V SPECIFIED POWER TRENCH MOSFET; NCH; SC89; PD-(0.625W); I-(0.6A); V-(20V)
Q200		1	DMG3420U	DIODES INCORPORATED	DMG3420U	TRAN; N-CHANNEL ENHANCEMENT MODE MOSFET; NCH; SOT-23; PD-(0.74W); I-(5.47A); V-(20V)
Q201	Do not install	1	PSMN022-30PL	NXP	PSMN022-30PL	TRAN; N-CHANNEL 30V 22MOHM LOGIC LEVEL MOSFET; NCH; TO-220AB; PD-(41W); I-(30A); V-(30V)
Q202		1	IRLR8259PBF	INTERNATIONAL RECTIFIER	IRLR8259PBF	TRAN; HEXFET POWER MOSFET; NCH; DPAK; PD-(48W); I-(57A); V-(25V)
QSCL, QSDA		2	5002	KEYSTONE		TEST POINT; PIN DIA=0.1IN; TOTAL LENGTH=0.3IN; BOARD HOLE=0.04IN; WHITE; PHOSPHOR BRONZE WIRE SILVER;
R1, R115, R157, R159, R161, R214, R283		7			100K	RESISTOR; 0402; 100K; 1%; 100PPM; 0.0625W; THICK FILM; FORMFACTOR
R2, R4, R5		3			0	RESISTOR; 0402; 0 OHM; 0%; JUMPER; 0.10W; THICK FILM; FORMFACTOR
R3	Do not install	1			OPEN	RESISTOR; 0402; OPEN; FORMFACTOR
R6, R7, R120		3	CRCW0402100KFK; RC0402FR-07100KL	VISHAY DALE; YAGEO PHICOMP	100K	RESISTOR; 0402; 100K; 1%; 100PPM; 0.0625W; THICK FILM
R100, R118		2			4.7K	RESISTOR, 0402, 4.7K OHM, 1%, 100PPM, 0.0625W, THICK FILM; FORMFACTOR
R103, R123		2			22	RESISTOR, 0402, 22 OHM, 1%, 100PPM, 0.0625W, THICK FILM; FORMFACTOR
R107, R108		2			2.2K	RESISTOR, 0402, 2.2K OHM, 1%, 100PPM, 0.0625W, THICK FILM; FORMFACTOR
R109, R111		2			100	RESISTOR; 0402; 100 OHM; 1%; 100PPM; 0.0625W; THICK FILM; FORMFACTOR
R110		1	CRCW0402470RFK	VISHAY DALE	470	RESISTOR, 0402, 470 OHM, 1%, 100PPM, 0.0625W, THICK FILM
R122		1			1M	RESISTOR; 0603; 1M; 1%; 100PPM; 0.10W; THICK FILM; FORMFACTOR

**MAX77756 EV System Bill of Materials (continued)**

REF_DES	DNI, DNP	QTY	MFG PART #	MFG	VALUE	DESCRIPTION
R135, R136, R139, R141, R143, R148, R155, R162-R165, R238, R247, R248, R305, R306		16			0	RESISTOR; 0402; 0 OHM; 1%; 100PPM; 0.0625W; THICK FILM; FORMFACTOR
R137, R138		2			49.9	RESISTOR; 0402; 49.9 OHM; 1%; 100PPM; 0.0625W; THICK FILM; FORMFACTOR
R142		1			0	RESISTOR; 0603; 0 OHM; 0%; JUMPER; 0.10W; THICK FILM; FORMFACTOR
R156		1	CRCW0402105KFK	VISHAY DALE	105K	RESISTOR; 0402; 105K OHM; 1%; 100PPM; 0.063W ; THICK FILM
R158		1	CRCW0402169KFK	VISHAY DALE	169K	RESISTOR; 0402; 169K OHM; 1%; 100PPM; 0.063W; THICK FILM
R160		1	CRCW04024752FK; 9C04021A4752FLHF3; CRCW040247K5FK	VISHAY DALE	47.5K	RESISTOR; 0402; 47.5K; 1%; 100PPM; 0.0625W; THICK FILM
R235		1	CRCW0402100RFK; 9C04021A1000FL; RC0402FR-07100RL	VISHAY DALE; PANASONIC; YAGEO PHYCOMP	100	RESISTOR; 0402; 100 OHM; 1%; 100PPM; 0.063W; THICK FILM
R236		1	CRCW0402680RFK;RC0402FR-07680RL	VISHAY DALE/YAGEO PHICOMP	680	RESISTOR; 0402; 680 OHM; 1%; 100PPM; 0.0625W; THICK FILM
R237		1	CRCW040220K0FK	VISHAY DALE	20K	RESISTOR; 0402; 20K OHM; 1%; 100PPM; 0.063W; THICK FILM
R239, R240		2	CRCW04024991FK	VISHAY DALE	4.99K	RESISTOR; 0402; 4.99K; 1%; 100PPM; 0.0625W; THICK FILM
R242, R243		2			1K	RESISTOR; 0402; 1K; 1%; 100PPM; 0.0625W; THICK FILM; FORMFACTOR
R244, R246, R251		3	CRCW04021M00FK	VISHAY DALE	1M	RESISTOR; 0402; 1M; 1%; 100PPM; 0.0625W; THICK FILM
R245		1	LRC-LR2512LF-01-R500-F	TT ELECTRONICS	0.5	RESISTOR; 2512; 0.5 OHM; 1%; 100PPM; 2.0W; METAL FILM
R249		1	CRCW080549R9FK; ERJ-6ENF49R9	VISHAY DALE; PANASONIC	49.9	RESISTOR; 0805; 49.9 OHM; 1%; 100PPM; 0.125W; THICK FILM
R252		1	CRCW040210K0FK; RC0402FR-0710K	VISHAY DALE; YAGEO PHICOMP	10K	RESISTOR; 0402; 10K; 1%; 100PPM; 0.0625W; THICK FILM
R297		1	ERJ-2RK4703X	PANASONIC	470K	RESISTOR; 0402; 470K OHM; 1%; 100PPM; 0.0625W; THICK FILM
R298		1	CRCW0402649KFK	VISHAY DALE	649K	RESISTOR; 0402; 649K OHM; 1%; 100PPM; 0.063W; THICK FILM

## MAX77756 EV System Bill of Materials (continued)

REF_DES	DNI, DNP	QTY	MFG PART #	MFG	VALUE	DESCRIPTION
U1		1	MAX77756BEWL+	MAXIM	MAX77756BEWL+	EVKIT PART-IC; PACKAGE OUTLINE 21-100111; PACKAGE CODE W151G2+1
U2		1	24AA02T-I/OT	MICROCHIP	24AA02T-I/OT	IC; EPROM; 2K I2C SERIAL EEPROM; SOT23-5
U100		1	MAXQ2000-RBX+	MAXIM	MAXQ2000-RBX+	IC; CTRL; LOW-POWER LCD MICROCONTROLLER; TQFN56-EP 8X8
U101		1	FT232RQ	FUTURE TECHNOLOGY DEVICES INTL LTD.	FT232RQ	IC; INFC; UART INTERFACE IC USB TO SERIAL; QFN32-EP 5X5
U102-U104		3	MAX8512EXK	MAXIM	MAX8512EXK	IC, VREG, Ultra-Low-Noise, High PSRR, Adjustable Vout, SC70-5
U107		1	MAX3395EETC	MAXIM	MAX3395EETC	IC; TRANS; 15KV ESD-PROTECTED HIGH-DRIVE CURRENT QUAD-LEVEL TRANSLATOR WITH SPEED-UP CIRCUITRY; TQFN12 4X4
U202		1	MAX44251AUA+	MAXIM	MAX44251AUA+	IC; OPAMP; ULTRA-PRECISION; LOW-NOISE OP AMP; UMAX8
U205		1	MAX5815AAUD+	MAXIM	MAX5815AAUD+	IC; DAC; ULTRA-SMALL; QUAD-CHANNEL; 12-BIT BUFFERED OUTPUT DAC WITH INTERNAL REFERENCE AND I2C INTERFACE; TSSOP14
Y101		1	CX3225SB16000D0FLJZZ	KYOCERA-KINSEKI	16MHZ	CRYSTAL; SMT (3225) 3.2X2.5; 8PF; 16MHZ; +/-10PPM; +/-15PPM
—	—	1	MAX77756EVKIT#	MAXIM	—	PCB: MAX77756 EVKIT
		163				

**MAX77756 EV System Schematic**

Part Number	Configuration	7-bit	8-bit Write	8-bit Read
MAX77756 (PMIC)	N/A	0X1E 0b001 1110	0X3C 0b0011 1100	0x3D 0b0011 1101
MAX11614 (ADC)	N/A	0x33 0b011 0011	0x66 0b0110 0110	0x67 0b0110 0111
MAX5815 (DAC)	ADDR1=ADDR0=GND	0x10 0b001 0000	0x20 0b0010 0000 0x10* 0b0001 0000	0x21 0b0010 0001
24AA02 (EEPROM)	N/A	0x50 to 0x57 0b1010xxx	0b1010xxx0	0b1010xxx1

\*MAX5815 ALSO RESPONDS TO AN I2C BROADCAST ADDRESS 0b0001 0000

MAX77756 EV System Schematic (continued)

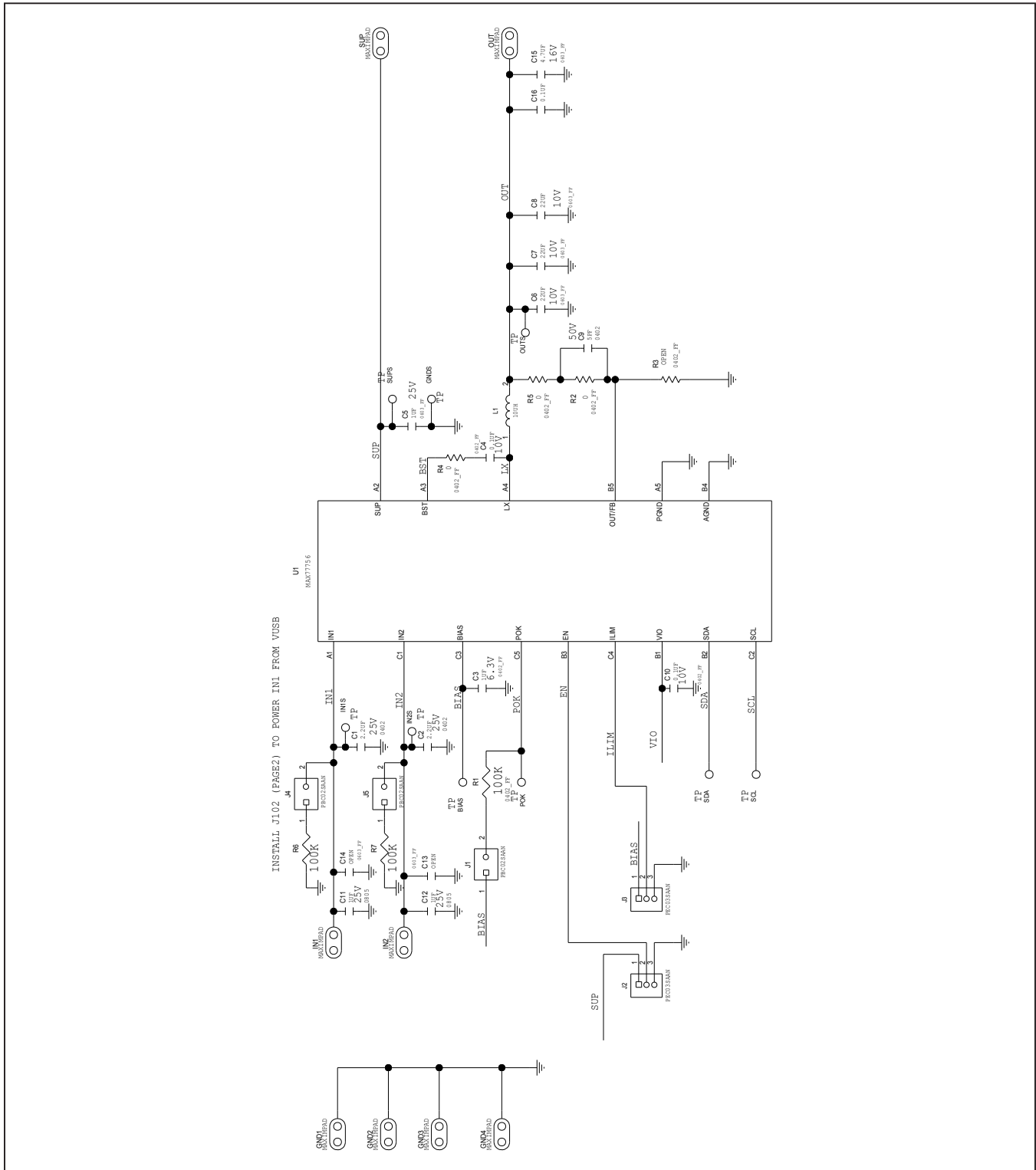

MAX77756 EV System Schematic (continued)

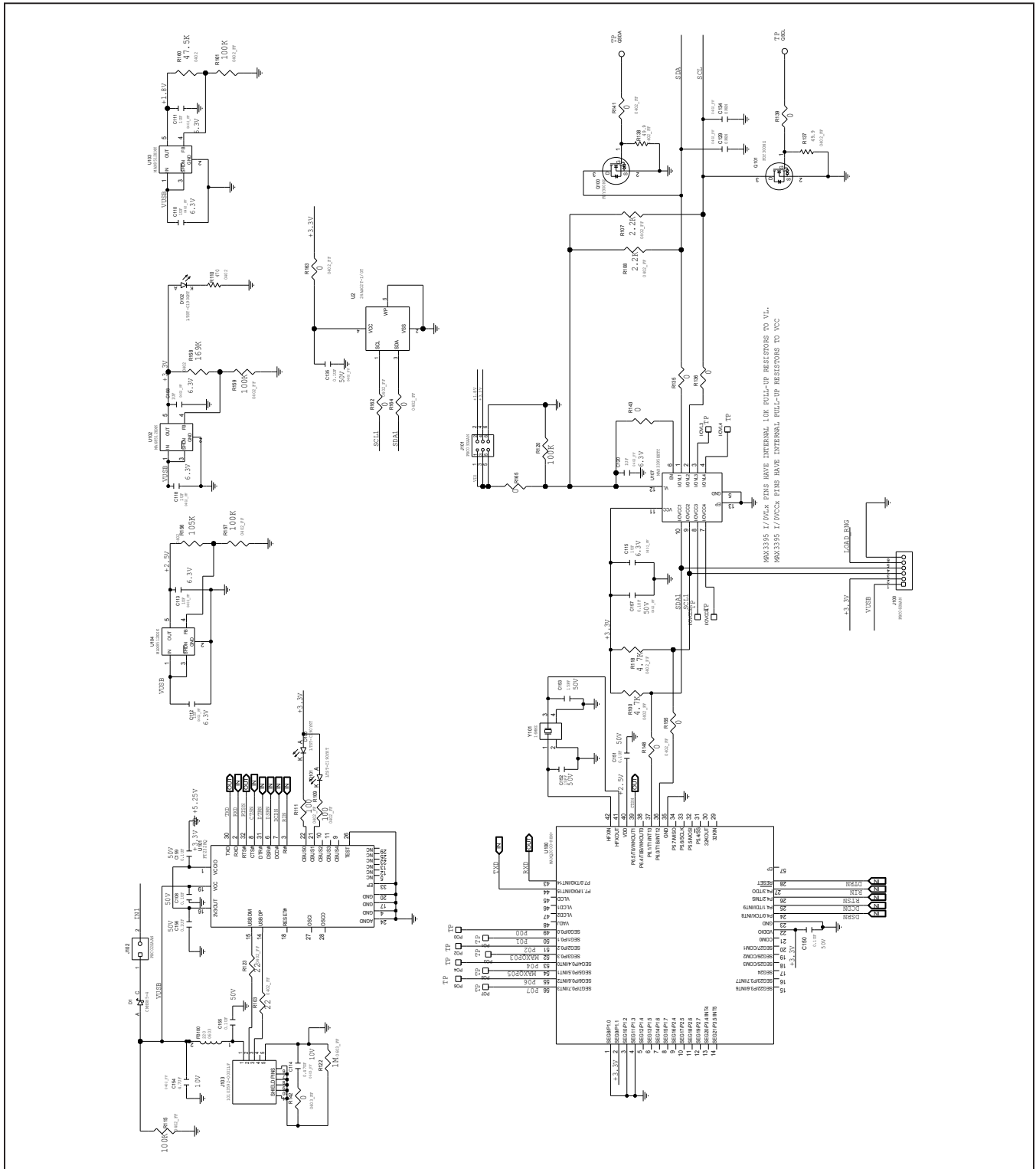



MAX77756 EV System Schematic (continued)

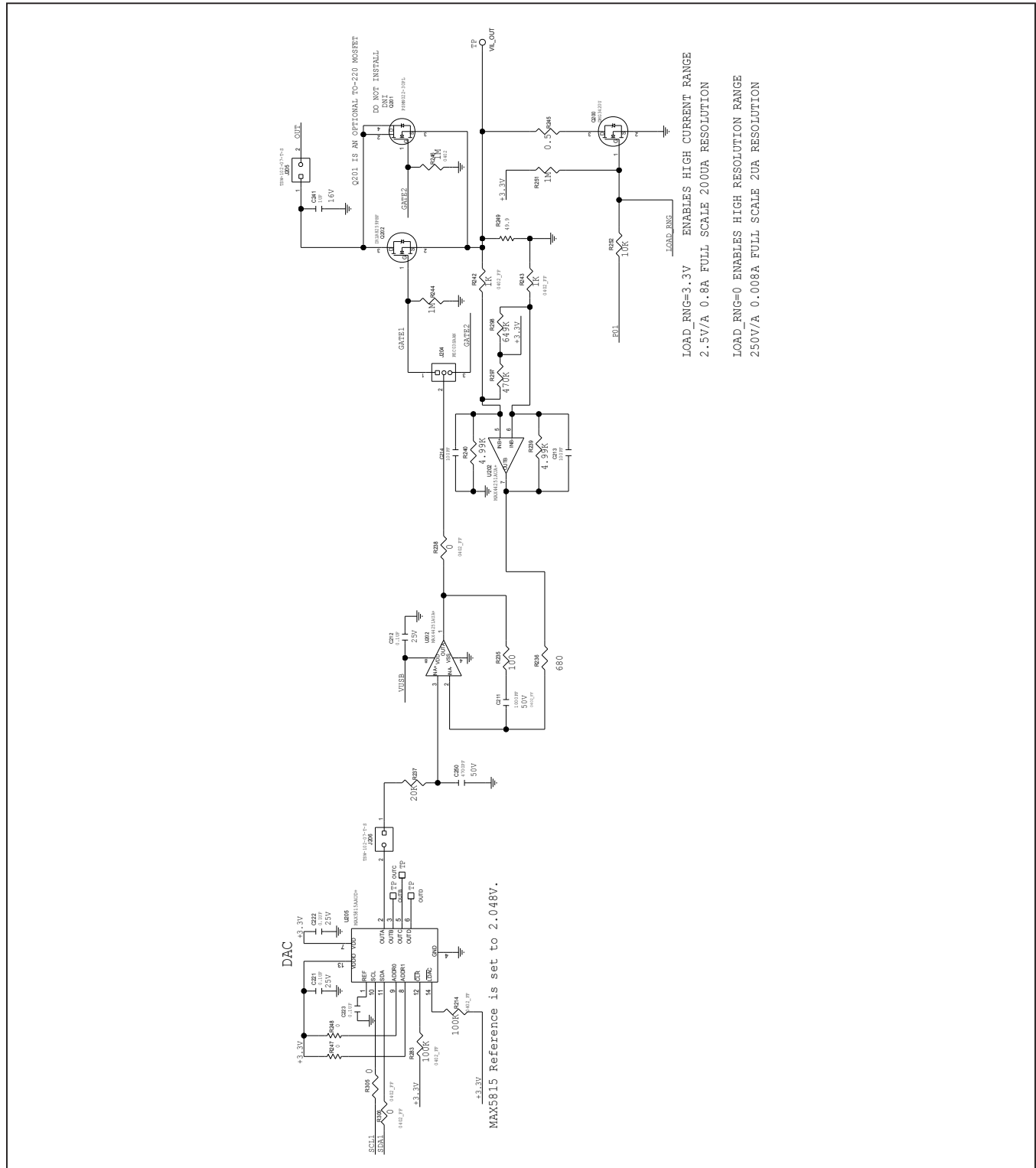

MAX77756 EV System PCB Layout

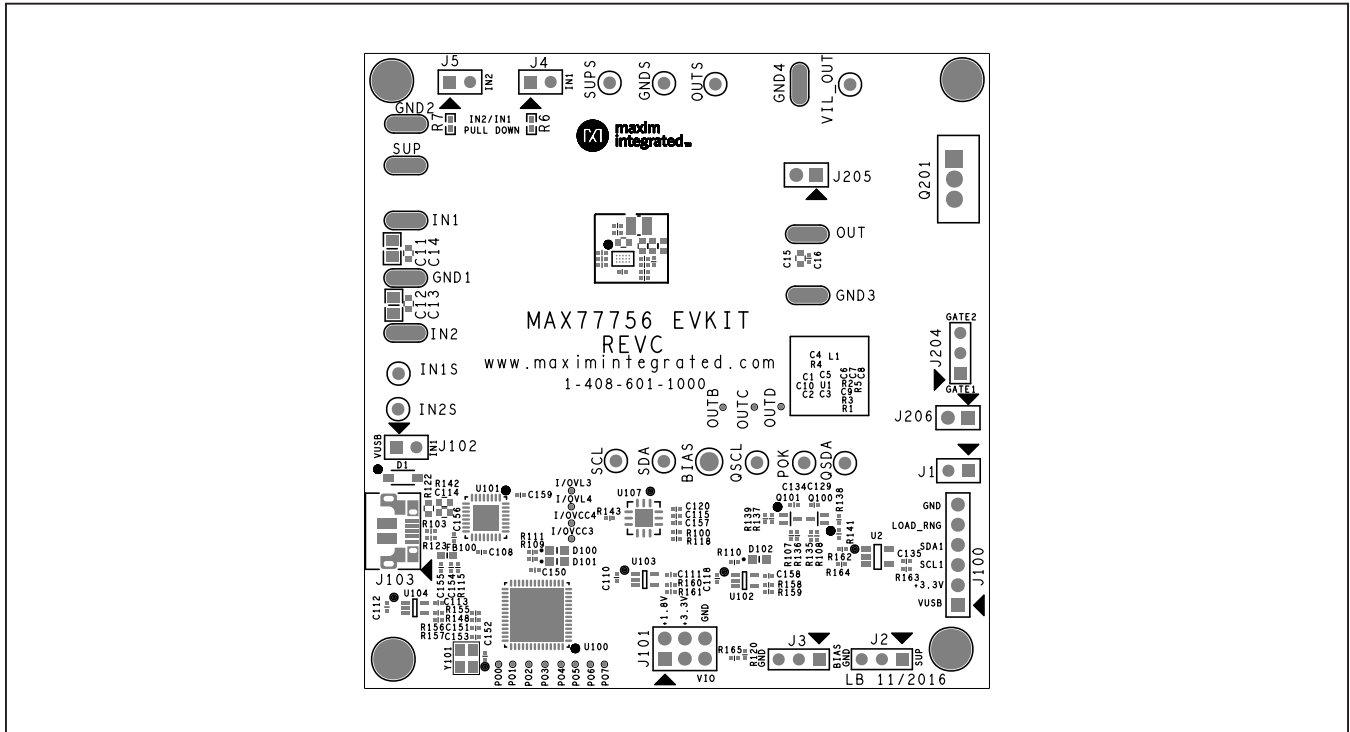

MAX77756 EV Kit Component Placement Guide—Top Silkscreen

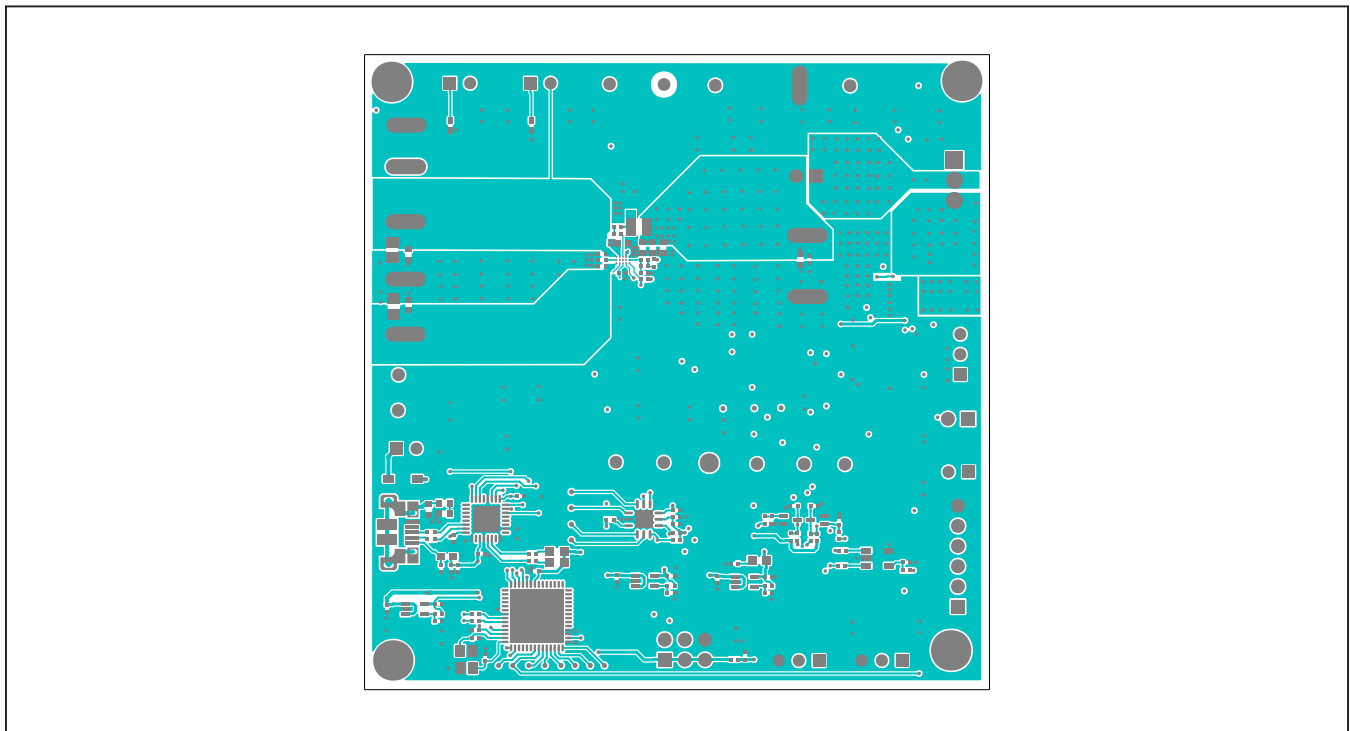

MAX77756 EV Kit PCB Layout—Top Layer

**MAX77756 EV System PCB Layout (continued)**

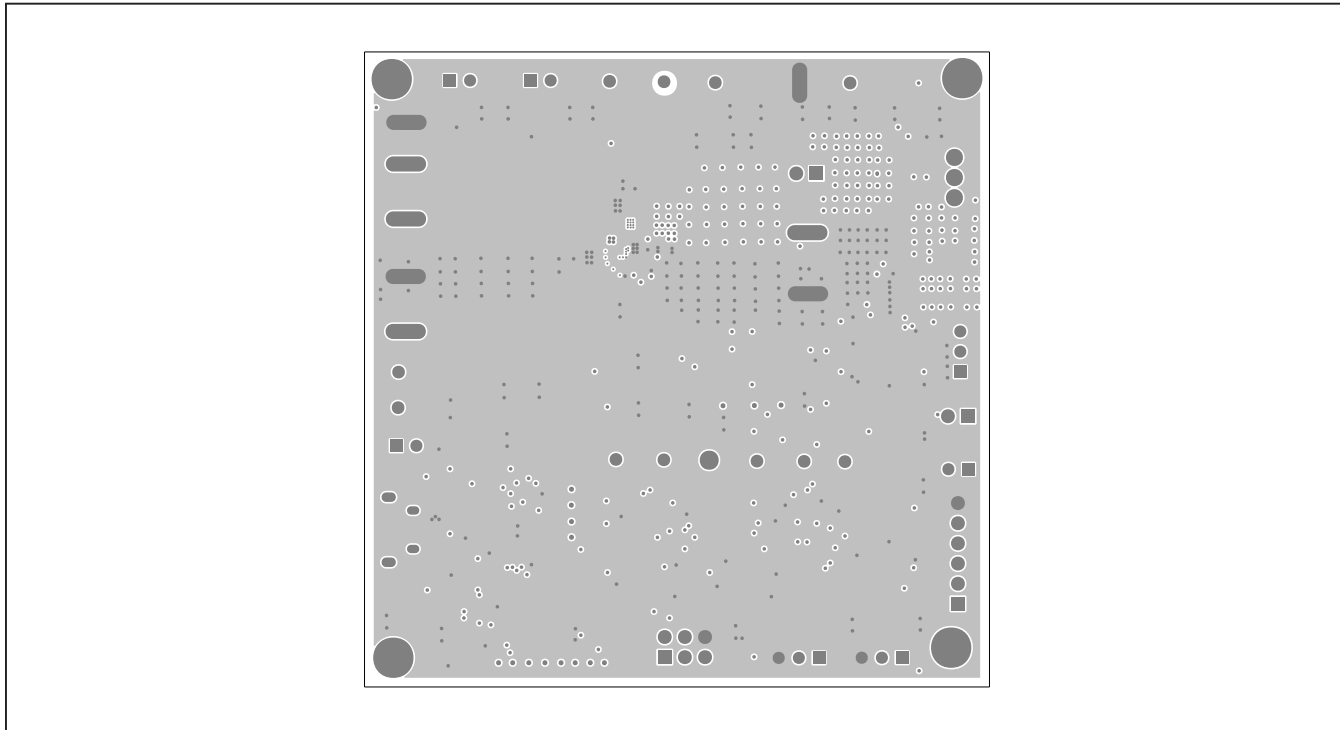

MAX77756 EV Kit PCB Layout—Internal Layer 2

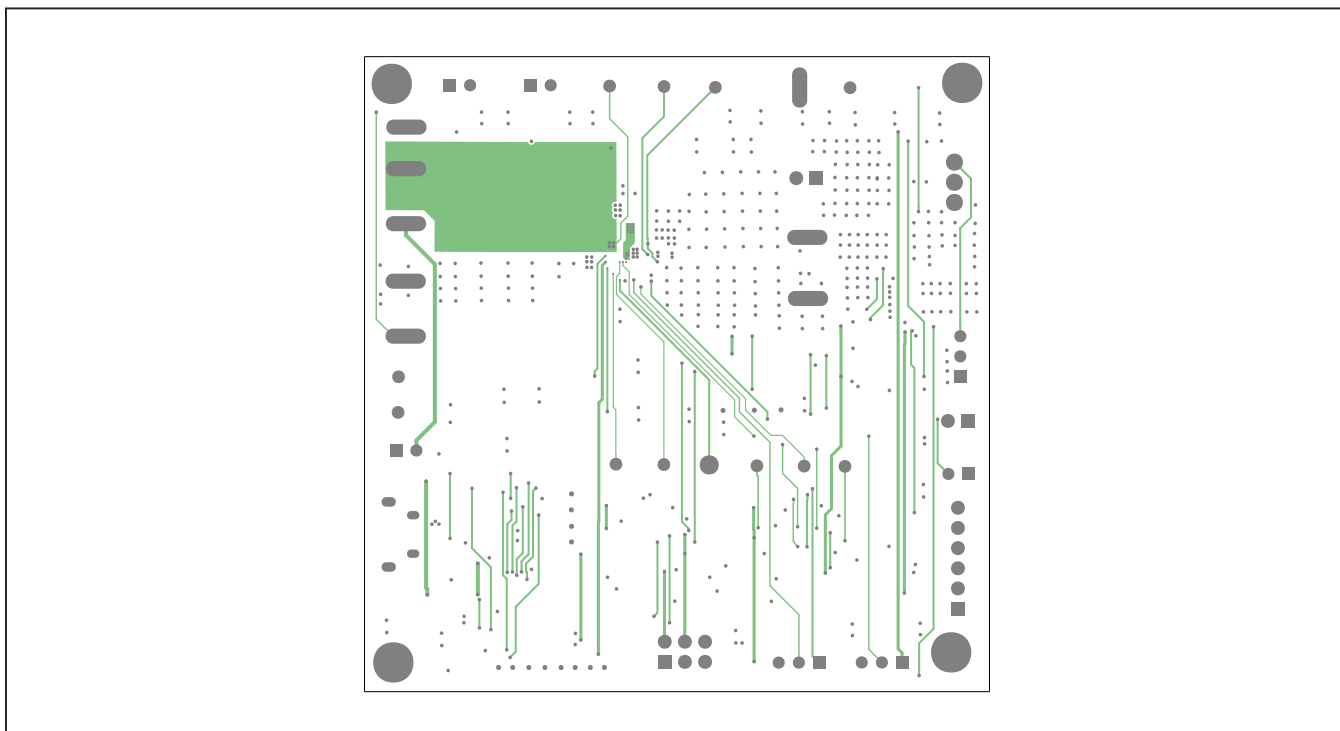

MAX77756 EV Kit PCB Layout—Internal Layer 3

MAX77756 EV System PCB Layout (continued)

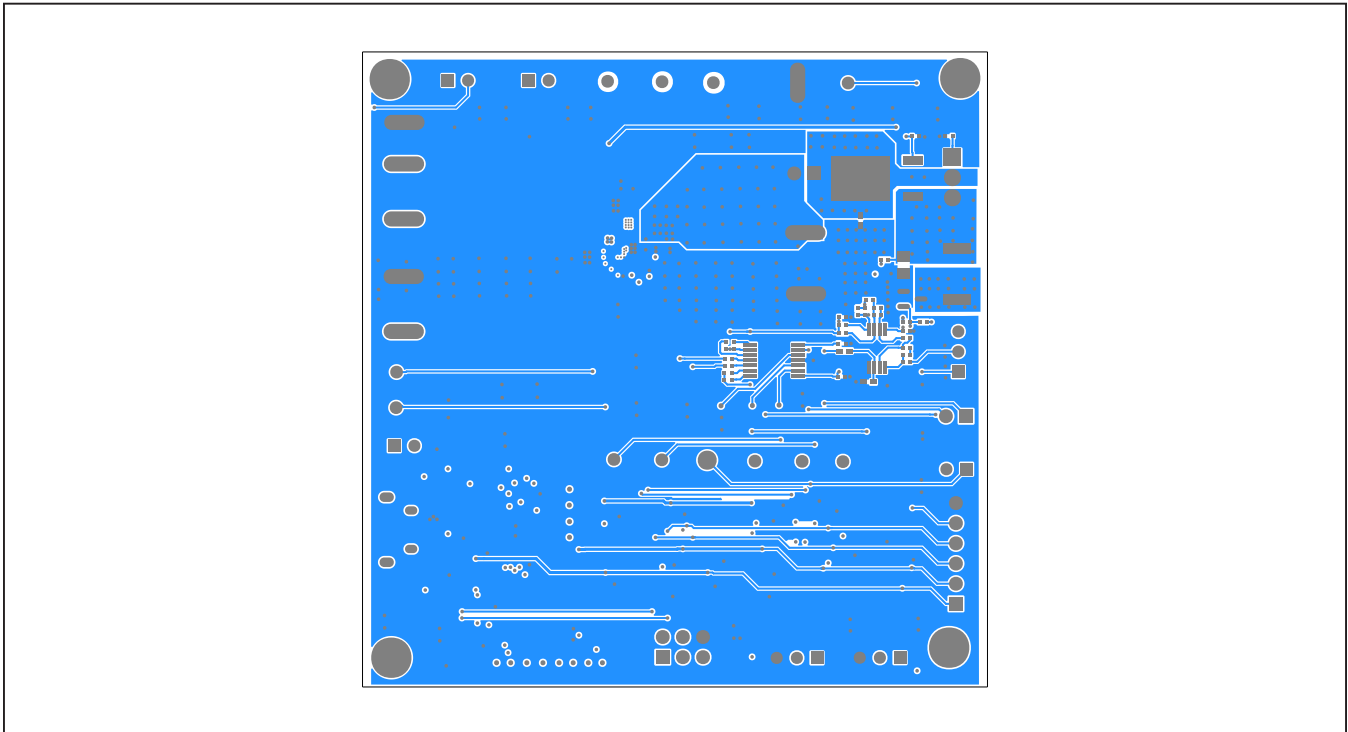

MAX77756 EV Kit PCB Layout—Bottom Layer

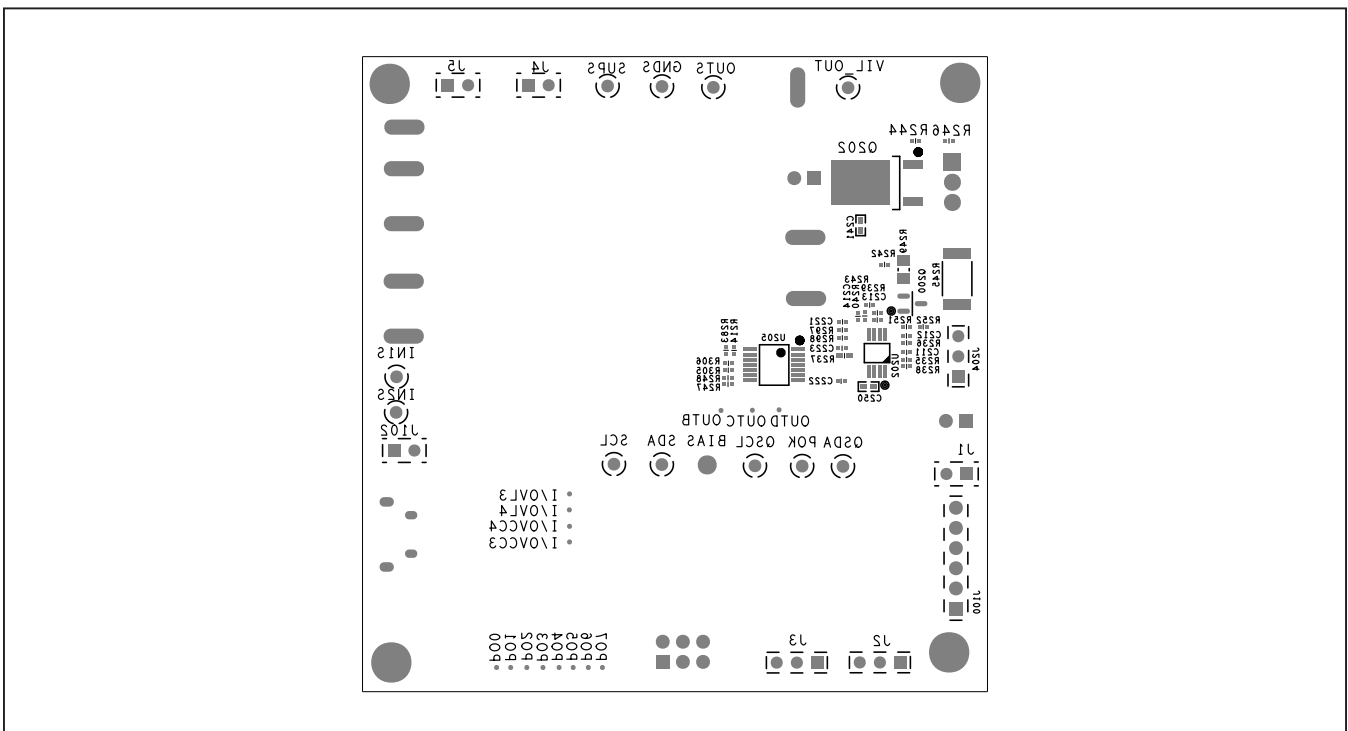

### Revision History

REVISION NUMBER	REVISION DATE	DESCRIPTION	PAGES CHANGED
0	1/17	Initial release	—

For pricing, delivery, and ordering information, please contact Maxim Direct at 1-888-629-4642, or visit Maxim Integrated's website at [www.maximintegrated.com](http://www.maximintegrated.com).

*Maxim Integrated cannot assume responsibility for use of any circuitry other than circuitry entirely embodied in a Maxim Integrated product. No circuit patent licenses are implied. Maxim Integrated reserves the right to change the circuitry and specifications without notice at any time.*