



FEATURES

- Vertical SIP-mount small footprint package
- Output from 0.6 to 6 Volts up to 51 Watts
- Ultra-wide 4.5 to 13.8 Vdc input range
- Outstanding thermal performance and derating
- Extensive self-protection and short circuit features with no output reverse conduction
- On/Off control and trim functions
- High efficiency up to 93% with no heatsink
- Fully protected against temperature and voltage limits
- Designed to meet UL/IEC/EN60950-1 safety approvals

PRODUCT OVERVIEW

Fabricated on a Single Inline Package (SIP) module, the LSS-T/10-W12 series is a miniature non-isolated Point-of-Load (POL) switching DC/DC power converter for embedded applications. The converter offers both tight regulation and high efficiency directly at the power usage site. Typically, no extra outside components are required. The module mounts vertically, occupying a tiny board footprint. The upright mounting improves cooling airflow. Suggested applications include powering CPU's, distributed bus architectures (DBA) with a master bus power supply, programmable logic and mixed voltage systems.

Based on synchronous buck converter topology, the extraordinary efficiency means very low heat and little electrical noise. The ultra wide input range is 4.5 to 13.8 Volts. Additional features include quick transient response to step loads and

stable no-load operation. A key feature is selectable output voltage either by precision resistor, trim pot or user's voltage input. The output range is adjustable from 0.6 to 6 Vdc.

A wealth of protection features prevents damage to both the converter and outside circuits. Inputs are protected from undervoltage and outputs offer short circuit protection, overcurrent and excess temperature shut down. The unit is designed to meet all EMI/RFI certifications as well as HALT reliability. RoHS6 hazardous material compliance is specified as standard. All units are precision assembled in a highly automated computer-controlled surface mount facility with ISO-traceable manufacturing quality standards. Additional system functions include a remote On/Off control.

Simplified Block Diagram

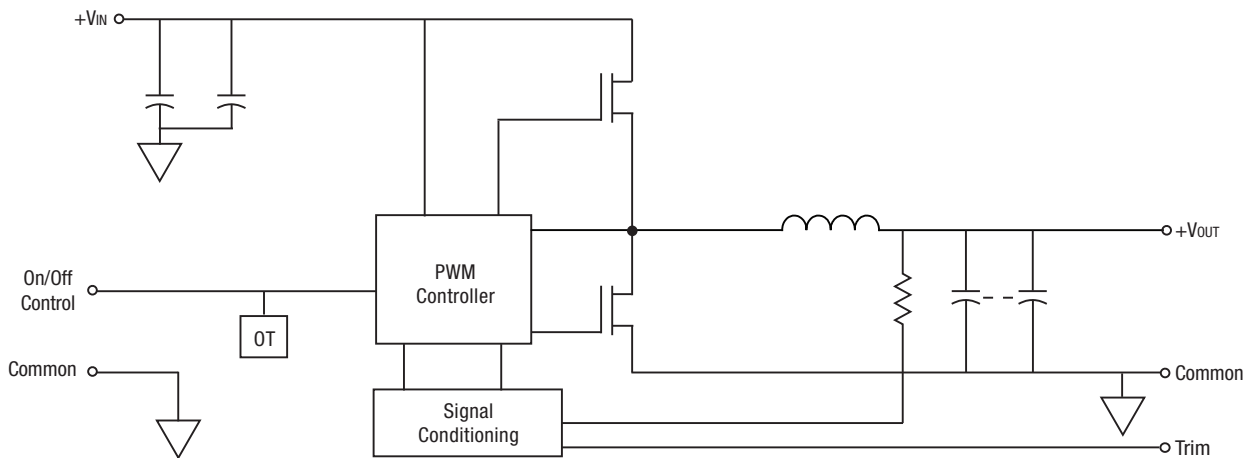

Typical topology is shown.

Figure 1. LSS-T/10-W12 Series, 10 Amp Model



Performance Specifications and Ordering Guide ^②

ORDERING GUIDE															
Root Model ^②	Output				Input				Efficiency		Package				
	V _{OUT} (Volts)	I _{OUT} (Amps max)	Power (Watts)	R/N (mVp-p) ^②		Regulation (Max.) ^③		V _{IN} Nom. (Volts)	Range (Volts)	I _{IN} , no load (mA)	I _{IN} , full load (Amps)	Min.	Typ.	Case C72 ^①	Pinout
LSS-T/10-W12	0.591 – 6	10	60	45	75	±0.2%	±1.4%	12	4.5 – 13.8	80	4.48	91.5	93	0.41 × 0.65 × 0.4 (10.4 × 16.5 × 10.2)	P73

① Dimensions are in inches (mm).

② All specifications are at nominal line voltage, V_{OUT} = 5V and full load, +25 °C unless otherwise noted. See detailed specifications. Output capacitors are 2 x 0.47 µF ceramic. Input cap is 22 µF.

I/O caps are necessary for our test equipment and may not be needed for your application.

③ V_{IN} must be 2V or higher than V_{OUT} for 3.3 to 5V outputs.

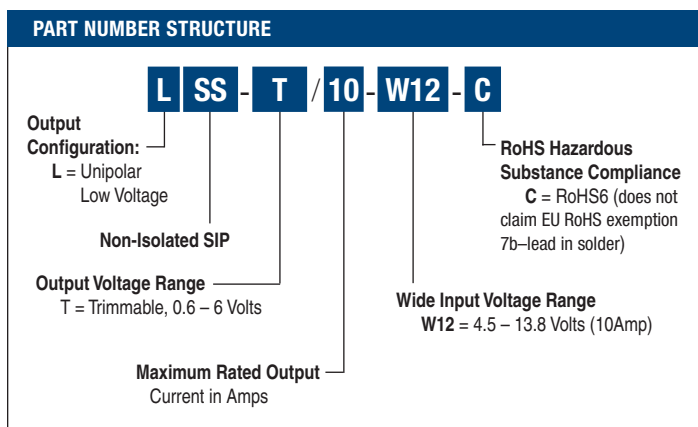

MECHANICAL SPECIFICATIONS

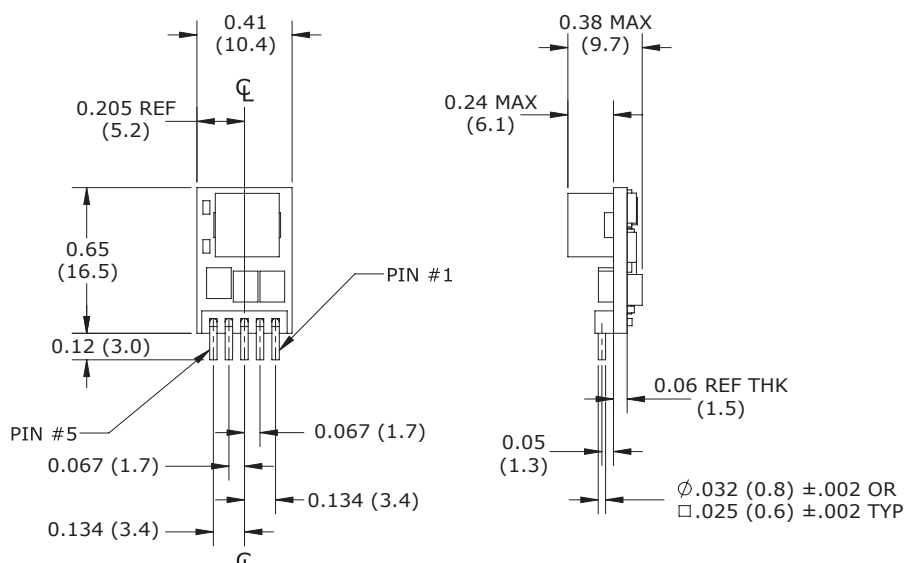
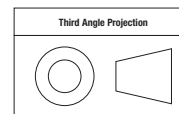

Figure 2 . LSS-T/10-W12 Series
Component locations are typical.

INPUT/OUTPUT CONNECTIONS LSS-T/10-W12

Pin	Function P73
1	Enable On/Off
2	+V _{IN}
3	Ground
4	+V _{OUT}
5	Output Trim

Dimensions are in inches (mm) shown for ref. only.



Tolerances (unless otherwise specified):
.XX ± 0.02 (0.5)
.XXX ± 0.010 (0.25)
Angles ± 2°

Components are shown for reference only.

Performance/Functional Specifications

All specifications are typical unless noted See Note 1.

Input	
Input Voltage Range	See Ordering Guide. See note 19.
Recommended External Fuse	20 Amps
Isolation	Not isolated. The input and output commons internally connected.
Start-up Voltage	4.2 Volts
Undervoltage Shutdown	3.4 Volts
Overvoltage Shutdown	None
Reflected (Back) Ripple Current	20 mA pk-pk
Internal Input Filter Type	Capacitive
Reverse Polarity Protection ¹ (Note 15)	See fuse information
Input Current:	
Full Load Conditions	See Ordering Guide
Inrush Transient	0.4 A ² sec
Shutdown mode (Off, UV, OT)	5 mA
Output Short-Circuit	60 mA
No load, 5V _{out}	80 mA
Low Line (V _{in} = V _{min} , 5V _{out})	11.95 Amps
Remote On/Off Control (Note 5) (LSS-T/10-W12, no suffix)	
Positive Logic	On = +1.5 V to plus V _{in} max. or open pin Off = 0 to +0.2 V max. or ground pin
Current	1 mA
Output	
Minimum Loading (Note 7)	No minimum load
Maximum Output Power	51 Watts (Note 11)
Accuracy (50% load)	±1.5% of V setting
Voltage Adjustment Range (Notes 13, 19)	See Ordering Guide
Temperature Coefficient	±0.02% max. per °C of V _{out} range
Ripple/Noise (20MHz bandwidth)	See Ordering Guide and Note 8
Line Load Regulation (See Tech Notes)	See Ordering Guide and Note 10
Efficiency	See Ordering Guide
Maximum Capacitive Loading	
Cap-ESR = 0.001 to 0.01 Ω	5,000 μF
Cap-ESR > 0.01 Ω	10,000 μF
Current Limit Inception (98% of V_{out} setting) (Note 12)	
	33 Amps (after warm up)
Short Circuit Mode (Note 6, 12)	
Short Circuit Current Output	0.6 Amp
Protection Method	Hiccup autorecovery upon overload removal. (Note 16)
Short Circuit Duration	Continuous, no damage (output shorted to ground)

Dynamic Characteristics

Dynamic Load Response	20 μSec to within ±2% of final value (0 to 50% load step, di/dt = 10A/μSec, no external caps)
Turn-On Time	6 mSec for V _{out} regulated
Remote On/Off Time	6 mSec for V _{out} regulated
Switching Frequency	600 kHz

Environmental

Calculated MTBF (Note 4)	TBC
Operating Temperature Range With Derating	-45 to +85°C (Note 9) See Derating Curves (Note 18)
Storage Temperature Range	-55 to +125°C
Thermal Protection Shutdown	+115°C
Relative Humidity	85%/+85°C

Physical

Outline Dimensions	See Mechanical Specifications
Weight	0.07 ounces (2 grams)
Electromagnetic Interference (may require external filter)	Designed to meet FCC Part 15, EN55022, conducted and radiated
Safety	Designed to meet UL/cUL 60950-1, CSA-C22.2 No. 60950-1, IEC/EN 60950-1

Absolute Maximum Ratings

Input Voltage Continuous or transient	15 Volts max.
Output Power	51 Watts max.
On/Off Control	0V. min to +V _{in} max.
Input Reverse-Polarity Protection	See Fuse section
Output Current	Current limited. Devices can withstand sustained output short circuits without damage.
Storage Temperature	-40 to +125°C
Lead Temperature	See soldering guidelines

Absolute maximums are stress ratings. Exposure of devices to greater than any of these conditions may adversely affect long-term reliability. Proper operation under conditions other than those listed in the Performance/Functional Specifications Table is not implied nor recommended.

CAUTION: This product is not internally fused. To comply with safety agency certifications and to avoid injury to personnel or equipment, the user must supply an external fast-blow fuse to the input terminals. See fuse information.

Notes

- (1) All models are tested and specified with external 11110 μ F ceramic/tantalum output capacitors and a 22 μ F external input capacitor. All capacitors are low ESR types. These capacitors are necessary to accommodate our test equipment and may not be required to achieve specified performance in your applications. All models are stable and regulate within spec under no-load conditions.
All specifications are typical unless noted. General conditions for Specifications are +25 °C, V_{IN} =nominal, V_{OUT} =5V, full load. Adequate airflow must be supplied for extended testing under power.
- (2) Input Ripple Current is tested and specified over a 5 Hz to 20 MHz bandwidth. Input filtering is C_{IN} =2 \times 100 μ F, 100V tantalum, C_{BUS} =1000 μ F, 100V electrolytic, L_{BUS} =1 μ H.
- (3) Note that Maximum Power Derating curves indicate an average current at nominal input voltage. At higher temperatures and/or lower airflow, the DC/DC converter will tolerate brief full current outputs if the total RMS current over time does not exceed the Derating curve. All Derating curves are presented at sea level altitude. Be aware of reduced power dissipation with increasing density altitude.
- (4) Mean Time Before Failure is calculated using the Telcordia (Belcore) SR-332 Method 1, Case 3, ground fixed conditions, $T_{PCBOARD}$ =+25°C, full output load, natural air convection.
- (5) The On/Off Control is normally controlled by a switch or open collector or open drain transistor. But it may also be driven with external logic or by applying appropriate external voltages which are referenced to Input Common.
- (6) Short circuit shutdown begins when the output voltage degrades approximately 2% from the selected setting.
- (7) The outputs are not intended to sink appreciable reverse current. This may damage the outputs.
- (8) Output noise may be further reduced by adding an external filter. See I/O Filtering and Noise Reduction. Use only as much output filtering as needed *and no more*. Larger caps may slow transient response or degrade dynamic performance. Thoroughly test your system under full load, especially with low-ESR ceramic capacitors.
- (9) All models are fully operational and meet published specifications, including "cold start" at -40°C.
- (10) Regulation specifications describe the deviation as the line input voltage or output load current is varied from a nominal midpoint value to either extreme.
- (11) For the LSS-T/10-W12, the maximum rated output power is 51 Watts (5.1 Volts and 10 Amps). Output adjustment up to 6 Volts must reduce current to remain within the 51 Watt output limit.
- (12) Output current limit and short circuit protection is non-latching. When the overcurrent fault is removed, the converter will immediately recover.
- (13) Do not exceed maximum power specifications when adjusting the output trim.
- (14) At zero output current, the output may contain low frequency components which exceed the ripple specification. The output may be operated indefinitely with no load.
- (15) Input Fusing: If reverse polarity is accidentally applied to the input, a body diode will become forward biased and will conduct considerable current. To ensure reverse input protection with full output load, always connect an external input fast-blow fuse in series with the + V_{IN} input. Use approximately twice the full input current rating with nominal input voltage.
- (16) "Hiccup" overcurrent operation repeatedly attempts to restart the converter with a brief, full-current output. If the overcurrent condition still exists, the restart current will be removed and then tried again. This short current pulse prevents overheating and damaging the converter. Once the fault is removed, the converter immediately recovers normal operation.
- (17) Output accuracy is dependent on user-supplied trim resistors. To achieve high accuracy, use \pm 1% or better tolerance metal-film resistors.
- (18) At full power, on-board component package temperatures must not exceed +128°C.
- (19) V_{IN} must be 2 Volts or higher than V_{OUT} for +3.3 to +5V outputs.

Trim Connections

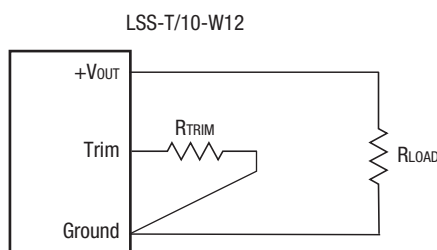

$$R_{TRIM} (k\Omega) = \frac{1.182}{V_{OUT} - 0.591}$$

Soldering Guidelines

Murata Power Solutions recommends the specifications below when installing these converters. These specifications vary depending on the solder type. Exceeding these specifications may cause damage to the product. Be cautious when there is high atmospheric humidity. We strongly recommend a mild pre-bake (100° C. for 30 minutes). Your production environment may differ; therefore please thoroughly review these guidelines with your process engineers.

Wave Solder Operations for through-hole mounted products (THMT)			
For Sn/Ag/Cu based solders:		For Sn/Pb based solders:	
Maximum Preheat Temperature	115° C.	Maximum Preheat Temperature	105° C.
Maximum Pot Temperature	270° C.	Maximum Pot Temperature	250° C.
Maximum Solder Dwell Time	7 seconds	Maximum Solder Dwell Time	6 seconds

PERFORMANCE DATA: EFFICIENCY VS LINE VOLTAGE AND LOAD CURRENT

Ta = +25°C

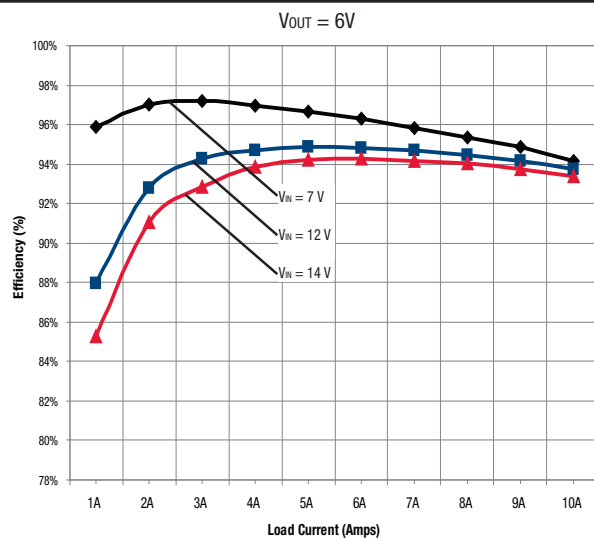
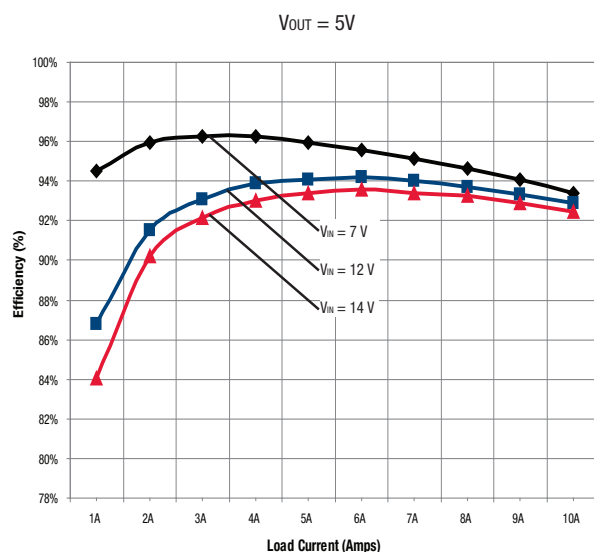
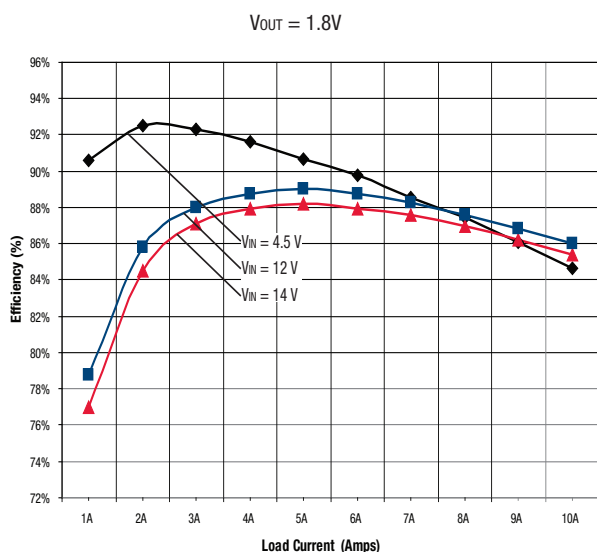
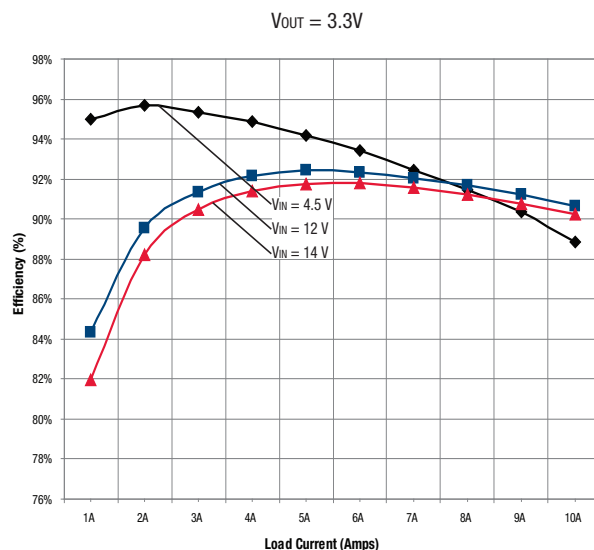
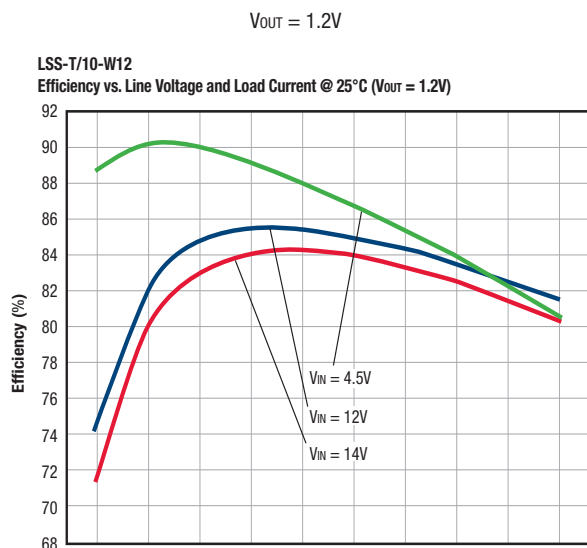

PERFORMANCE DATA: MAXIMUM CURRENT TEMPERATURE DERATING

($V_{in} = 12V$, transverse airflow, at sea level)

$V_{out} = 1.2V$

LSS-T/10-W12 Maximum Current Temperature Derating at sea level,
 $V_{in} = 12V$, transverse airflow, $V_{out} = 1.2V$,

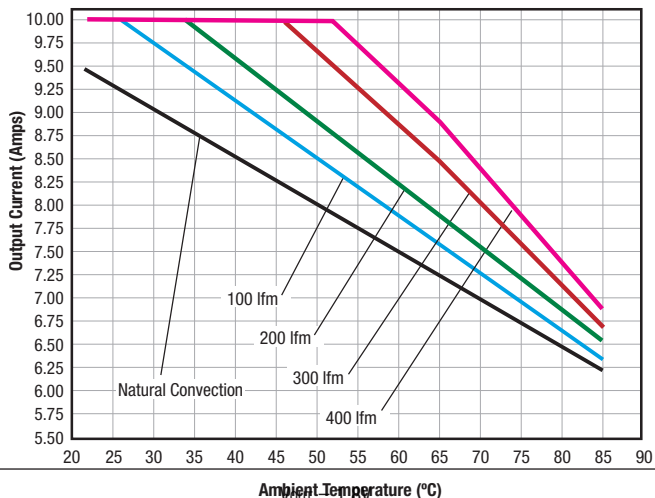

$V_{out} = 2.5V$

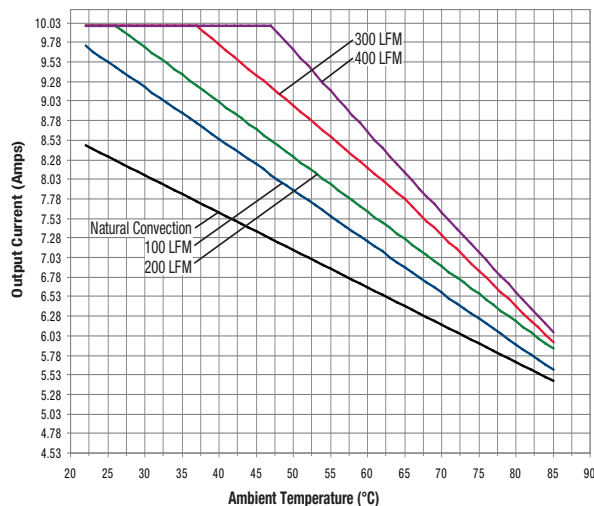

Ambient Temperature (°C)

$V_{out} = 3.3V$

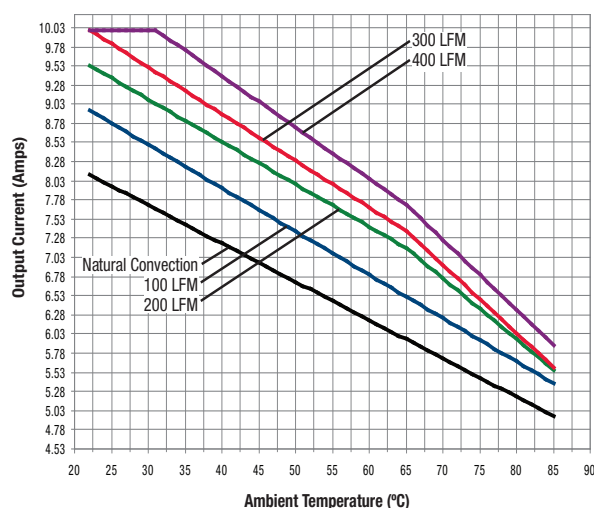
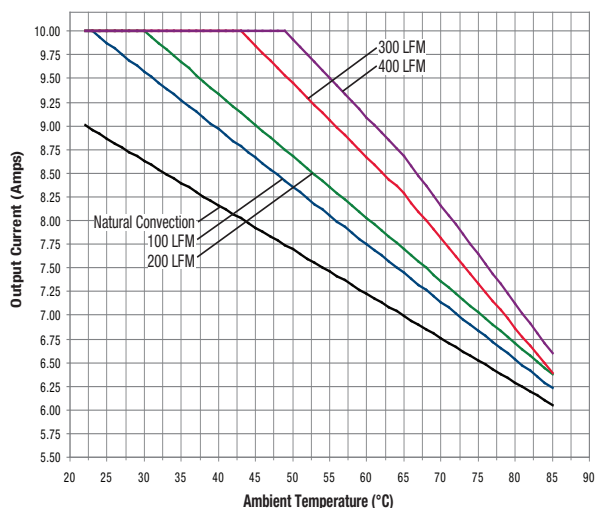

Ambient Temperature (°C)

Ambient Temperature (°C)

$V_{out} = 5V$

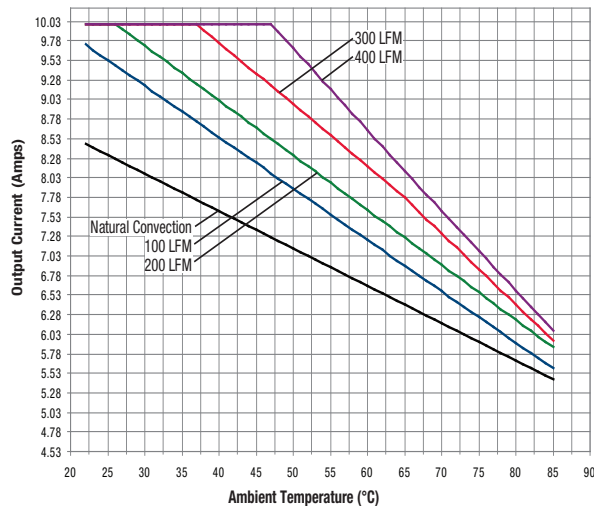

Ambient Temperature (°C)

PERFORMANCE DATA: OUTPUT RIPPLE AND NOISE (PARD)

V_{IN} = 12V

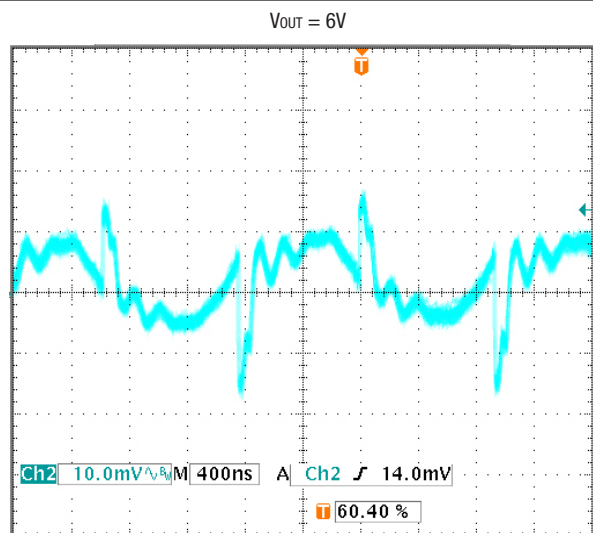
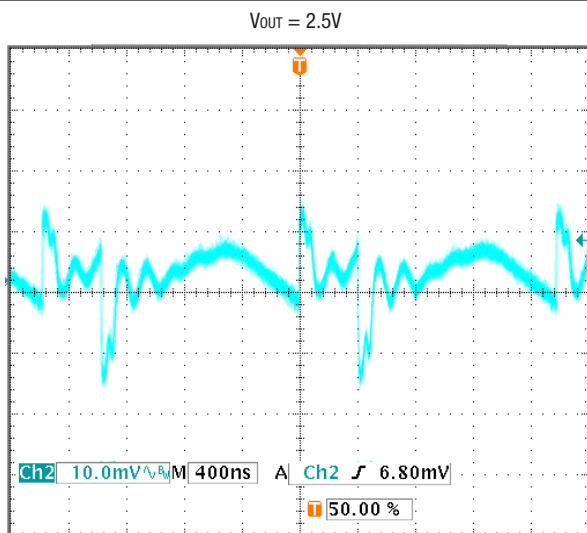
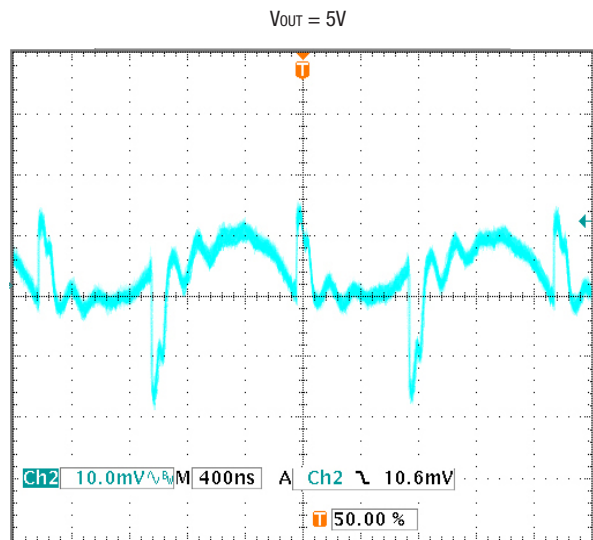
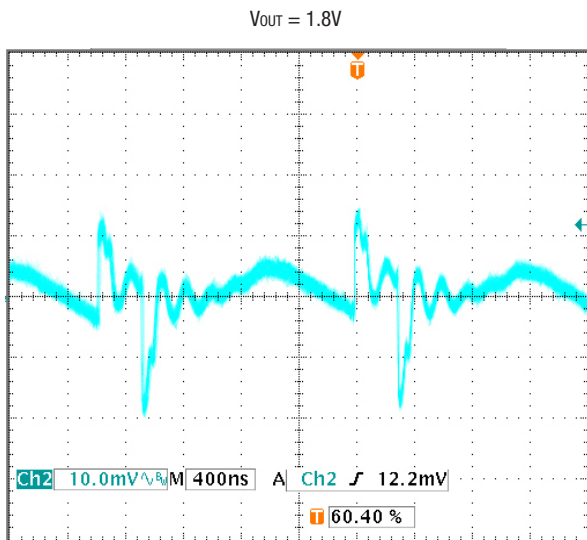
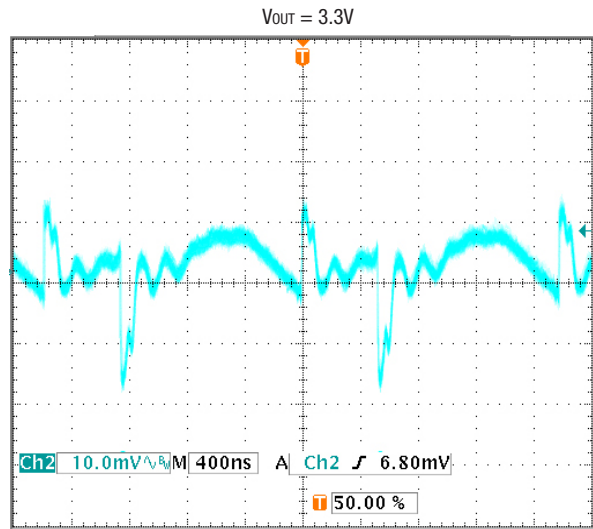
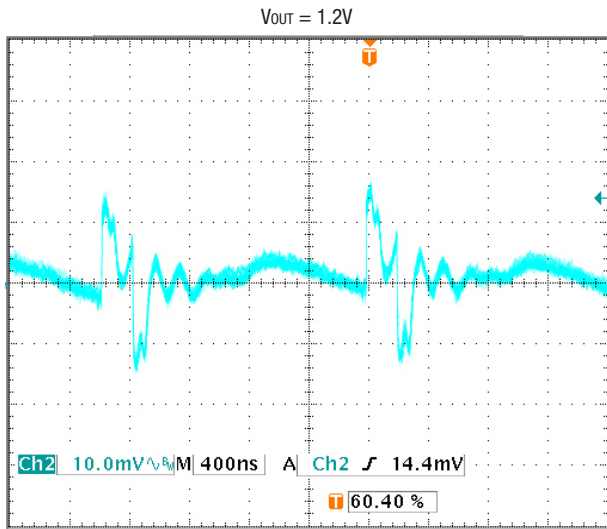

PERFORMANCE DATA: TURN-ON, TURN-OFF TIMES

V_{IN} = 12V

On/Off Enable

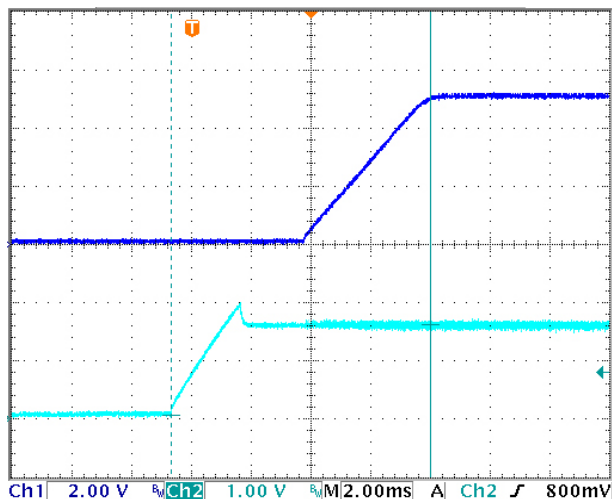

V_{IN} Power On

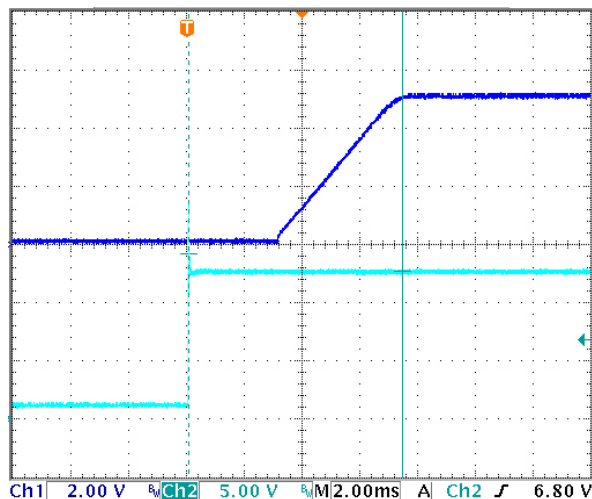

On/Off Disable

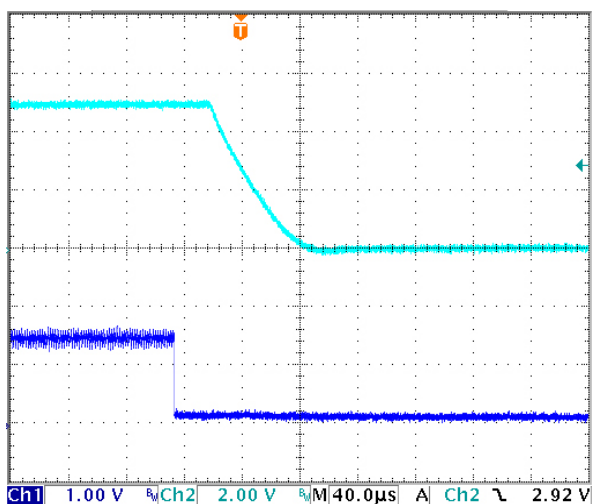

V_{IN} Power Off

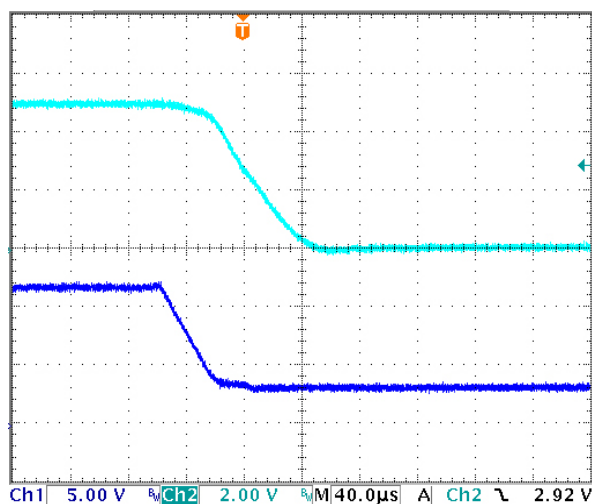

Murata Power Solutions, Inc.
11 Cabot Boulevard, Mansfield, MA 02048-1151 U.S.A.
ISO 9001 and 14001 REGISTERED



This product is subject to the following operating requirements and the Life and Safety Critical Application Sales Policy:
Refer to: <http://www.murata-ps.com/requirements/>

Murata Power Solutions, Inc. makes no representation that the use of its products in the circuits described herein, or the use of other technical information contained herein, will not infringe upon existing or future patent rights. The descriptions contained herein do not imply the granting of licenses to make, use, or sell equipment constructed in accordance therewith. Specifications are subject to change without notice. © 2017 Murata Power Solutions, Inc.