

0.75-5.5V 30A SMT Point-of Load Converter

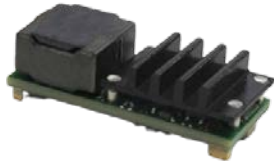

Features

- Efficiency up to 96.0% (3.3V/25A)
- Excellent thermal performance
- Output over-voltage, over-current, short-circuit and over-temperature protections
- Monotonic start-up into pre-biased load
- Fixed frequency operation
- UL 60950-1 2nd edition recognized[†]



Options

- Baseplate
- Negative / Positive enable logic
- Output voltage protection
- Output voltage tracking / Sequencing

Part Numbering System

NES	1	000	□	30	S	□	□
Series Name	Input Voltage	Output Voltage	Enabling Logic	Output Current	Pin Option	Electrical Options	Mechanical Options
	1: 8.5-18V	000: Variable* (0.75-5.5V)	P: Positive N: Negative	Unit: A 30: 30A	S: SMT	0: Default 1: Voltage Tracking (VT) 2: OVP 3: VT & OVP	5: Open frame 6: Baseplate

* Consult the factory for semi-custom codes with the output voltage set to a specific value without using an external programming resistor.

[†] UL is a registered trademark of Underwriters Laboratory Inc.

Absolute Maximum Rating

Excessive stresses over these absolute maximum ratings can cause permanent damage to the converter. Operation should be limited to the conditions outlined under the Electrical Specification Section.

Parameter	Min	Max	Unit
Input Voltage (continuous)	-0.5	22	Vdc
Operating Ambient Temperature (See Thermal Considerations section)	-40	85*	°C
Storage Temperature	-55	125	°C

*Derating curves provided in this datasheet end at 85°C ambient temperature. Operation above 85°C ambient temperature is allowed provided the temperatures of the key components or the baseplate do not exceed the limit stated in the Thermal Considerations section.

Electrical Specifications

These specifications are valid over the converter's full range of input voltage, resistive load, and temperature unless noted otherwise.

Input Specifications

Parameter	Min	Typical	Max	Unit	
Input Specifications					
Input Voltage	8.5	12	18	Vdc	
Input Current	-	-	20	A	
Quiescent Input Current (typical Vin)	-	80	150	mA	
Standby Input Current	-	2	-	mA	
Input Reflected-ripple Current, peak-to-peak (5-20 MHz, 12μH source impedance)	-	20	-	mA	
Input Turn-on Voltage Threshold	8.0	8.3	8.7	V	
Input Turn-off Voltage Threshold	7.8	8.2	8.4	V	
Output Specifications					
Output Voltage Set Point Accuracy (typical Vin; full load; Ta = 25°C)	-2.0	-	+2.0	%Vo	
Output Voltage Set Point Accuracy (over all conditions)	-2.5	-	+3.5	%Vo	
Output Regulation: Line Regulation (full range input voltage, 1/2 full load) Load Regulation (full range load, typical Vin) Temperature (Ta = -40°C to 85 °C)	- - -	0.2 0.3 0.2	- - -	%Vo	
Output Ripple and Noise Voltage RMS Peak-to-peak (5 Hz to 20 MHz bandwidth, typical Vin)	- -	- 3	1 -	%Vo	
Output Current	Vo ≤ 2.5V	0	-	30	A
	Vo > 2.5V	0	-	25	W
Efficiency (typical Vin; full load; Ta = 25°C)	Vo = 0.8V	-	77.0	-	%
	Vo = 1.25V	-	85.0	-	
	Vo = 1.8V	-	91.0	-	
	Vo = 2.5V	-	93.0	-	
	Vo = 3.3V	-	96.0	-	
Vo = 5V	-	96.0	-	-	
Output Over Current Protection Set Point	-	200	-	%	
Output Over Voltage Protection Set Point	115	125	135	%	

Output Ripple Frequency	270	300	330	kHz
External Load Capacitance	-	-	5,000	μF
Dynamic Response (typical Vin; Ta = 25°C; load transient 0.1A/μs) Load steps from 75% to 50% of full load:				
Peak deviation	-	120	-	mV
Settling time (within 10% band of Vo deviation)	-	70	-	μs
Load step from 50% to 75% of full load				
Peak deviation	-	120	-	mV
Settling time (within 10% band of Vo deviation)	-	70	-	μs
General Specifications				
Remote Enable				
Logic Low:				
ION/OFF = 1.0mA	0	-	0.5	V
VON/OFF = 0.0V	-	-	1.0	mA
Logic High:				
ION/OFF = 0.0μA	-	-	15	V
Leakage Current	-	-	50	μA
Calculated MTBF (Telecordia SR-332, 2011, Issue 3), full load, 40°C, 60% upper confidence level, typical Vin	-	10.7	-	10 ⁶ -hour

Characteristic Curves (Vo=0.8V)

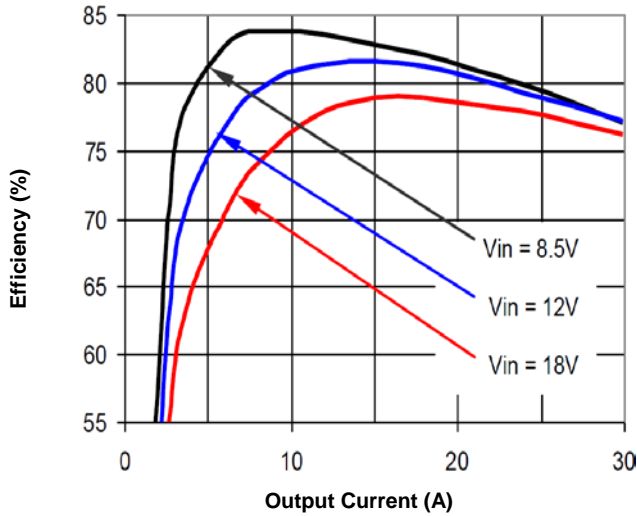

Figure 1a. Efficiency vs. Load Current (25°C)

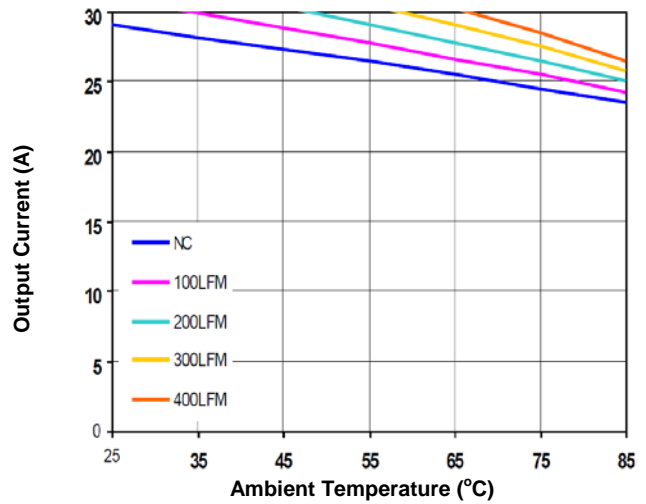

Figure 1b. Current Derating Curve
(Vin=12V, open frame)

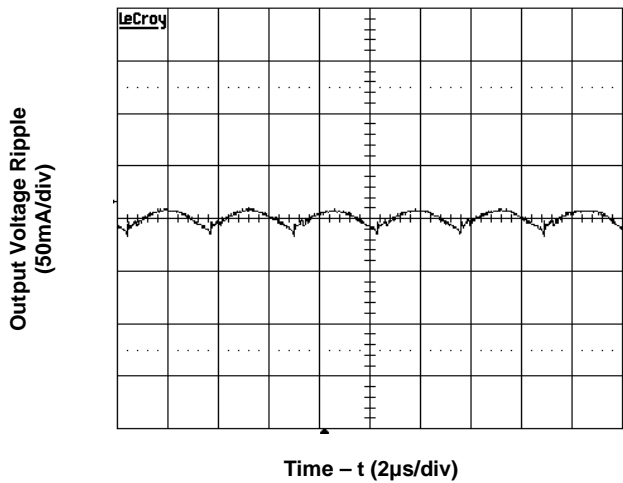

Figure 1c. Output Voltage Ripple (Vin=12V, full load)

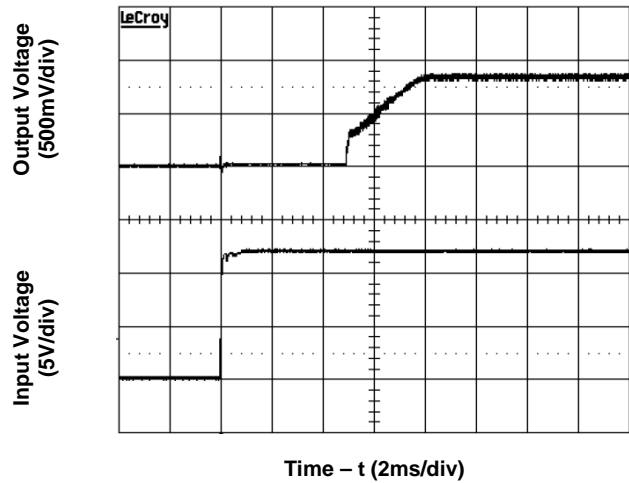
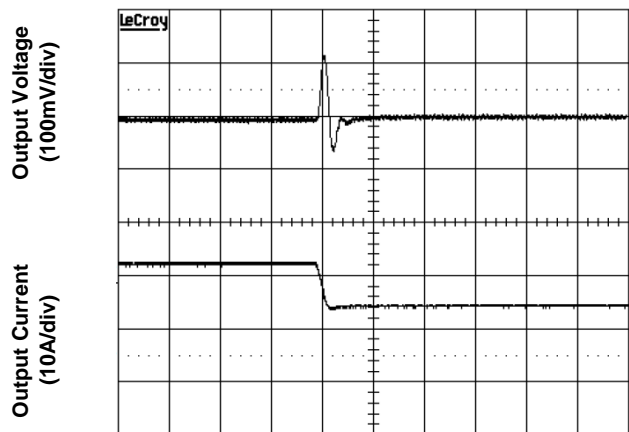
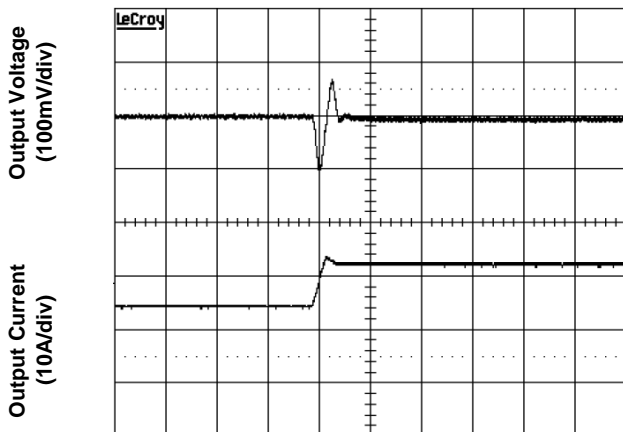

Figure 1d. Output Voltage (Vin=12V, full load)



Time – t (200µs/div)

Figure 1e. Transient Load Response
(typical V_{in} , load current steps from 50% to 75% at a slew rate 0.1A/µs)

Time – t (200µs/div)

Figure 1f. Transient Load Response
(typical V_{in} , load current steps from 75% to 50% at a slew rate 0.1A/µs)

Characteristic Curves ($V_o=1.25V$)

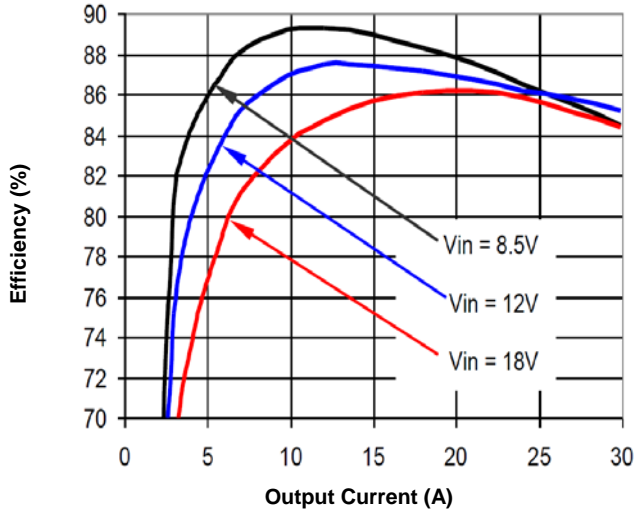

Figure 2a. Efficiency vs. Load Current (25°C)

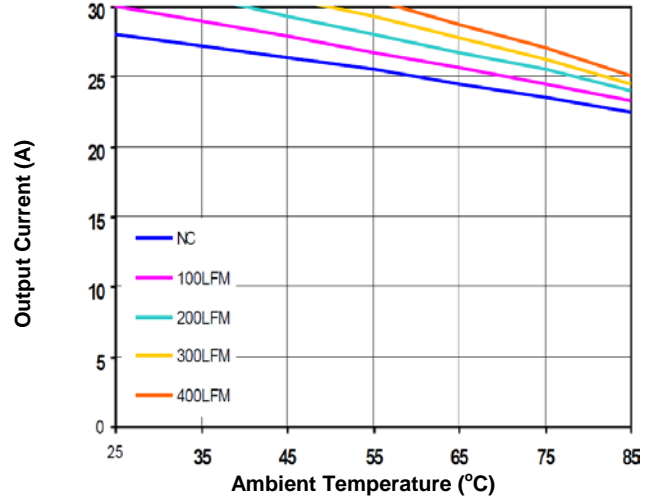

Figure 2b. Current Derating Curve
($V_{in}=12V$, open frame)

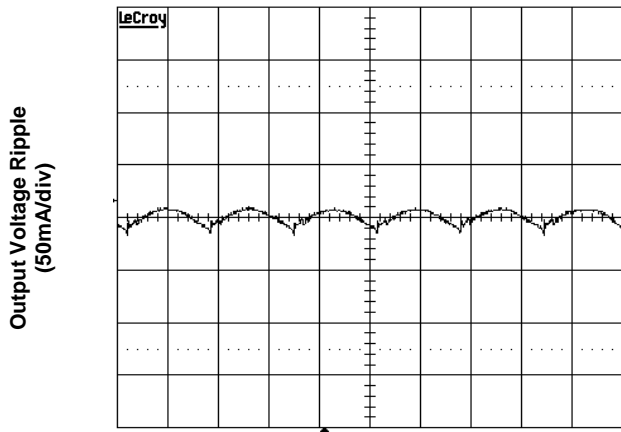

Figure 2c. Output Voltage (Vin=12V, full load)

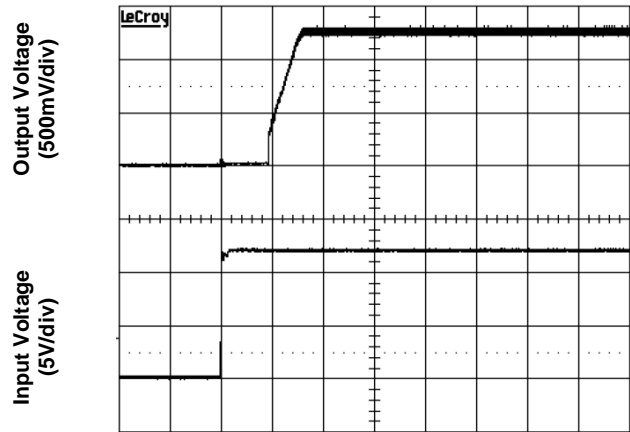
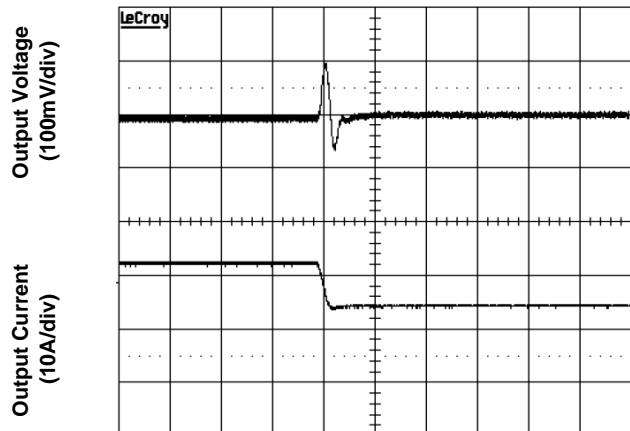
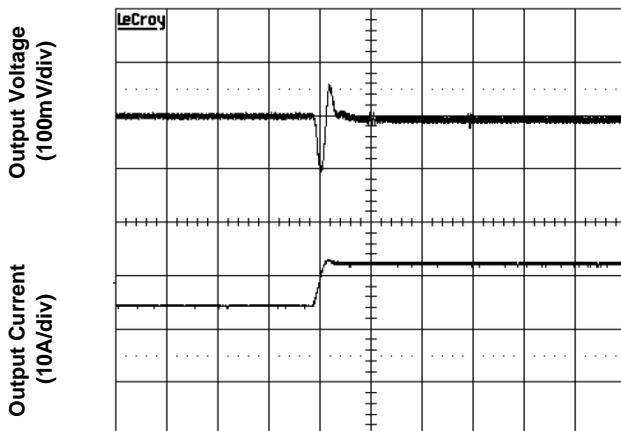

Figure 2d. Output Voltage (Vin=12V, full load)



Time – t (200 μ s/div)
Figure 2e. Transient Load Response
(typical V_{in} , load current steps from 50% to 75% at a slew rate 0.1A/ μ s)

Time – t (200 μ s/div)
Figure 2f. Transient Load Response
(typical V_{in} , load current steps from 75% to 50% at a slew rate 0.1A/ μ s)

Characteristic Curves ($V_o=1.8V$)

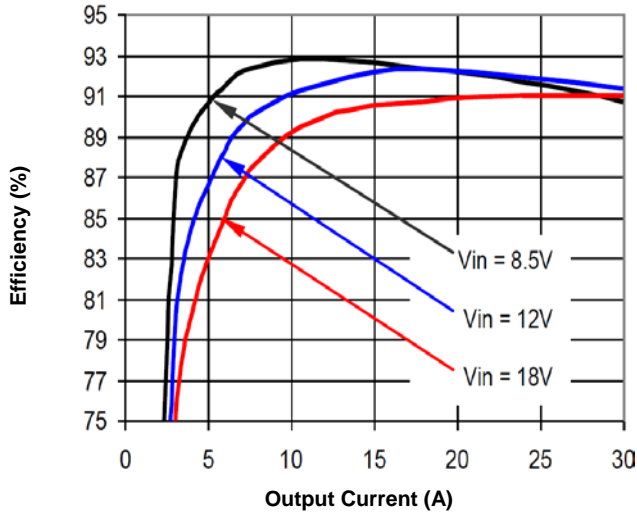

Figure 3a. Efficiency vs. Load Current (25°C)

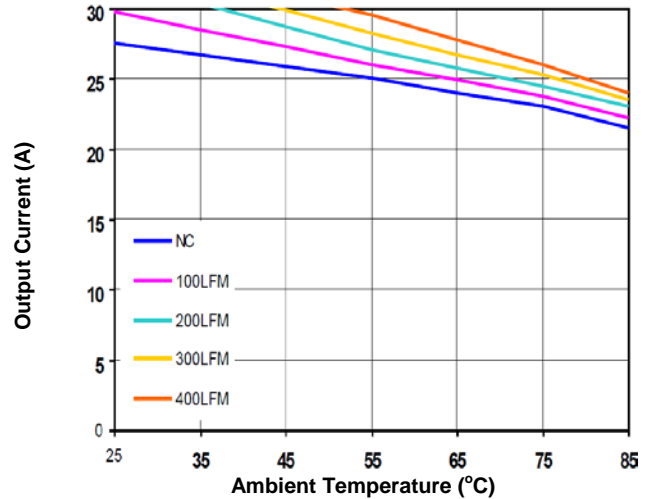
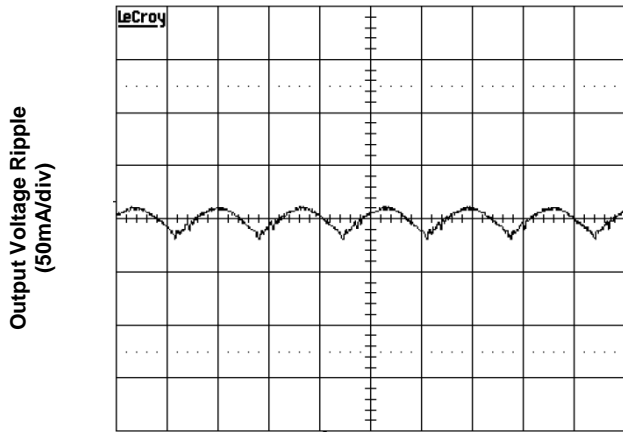
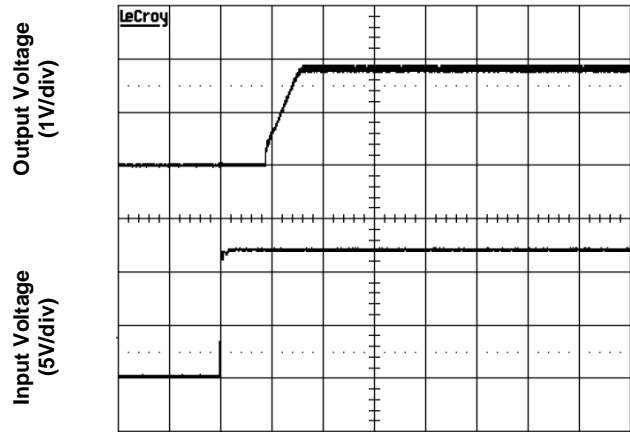

Figure 3b. Current Derating Curve
($V_{in}=12V$, open frame)



Time – t (2 μ s/div)
Figure 3c. Output Ripple Voltage ($V_{in}=12V$, full load)



Time – t (2ms/div)
Figure 3d. Output Ripple Voltage ($V_{in}=12V$, full load)

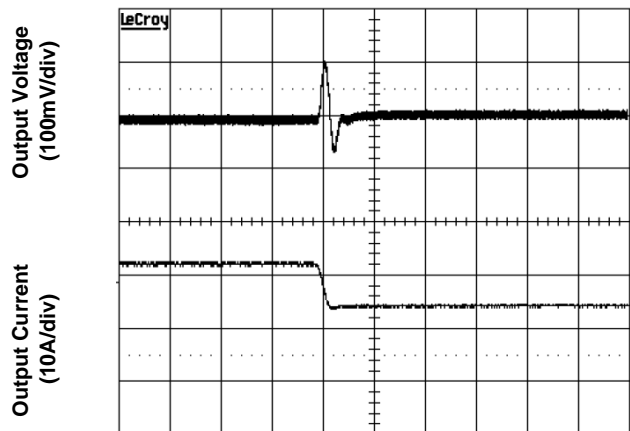
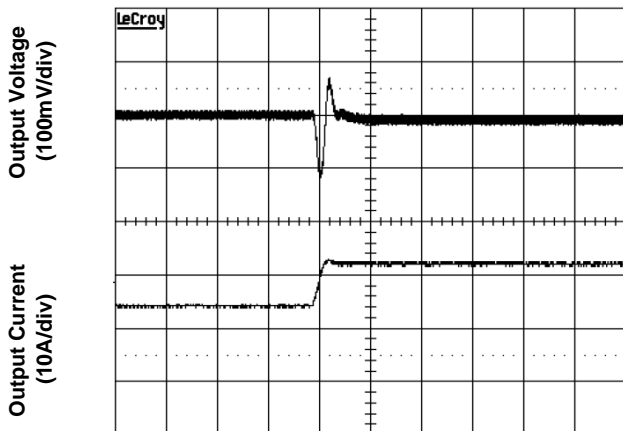

Time – t (200 μ s/div)
Figure 3e. Transient Load Response
 (typical V_{in} , load current steps from 50% to 75% at a slew rate 0.1A/ μ s)

Time – t (200 μ s/div)
Figure 3f. Transient Load Response
 (typical V_{in} , load current steps from 75% to 50% at a slew rate 0.1A/ μ s)

Characteristic Curves ($V_o=2.5V$)

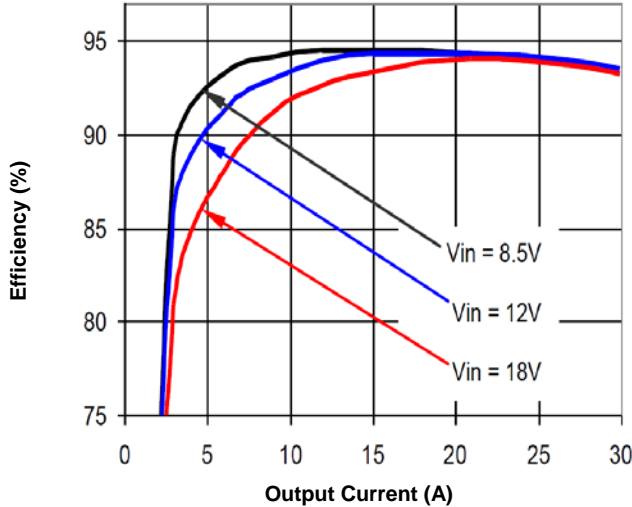

Figure 4a. Efficiency vs. Load Current (25°C)

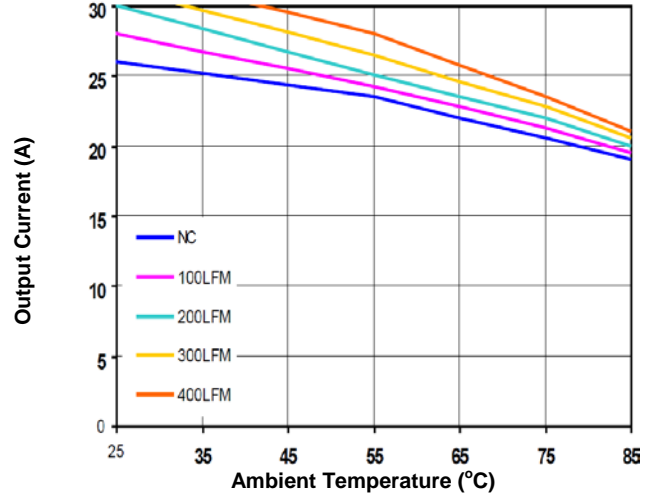
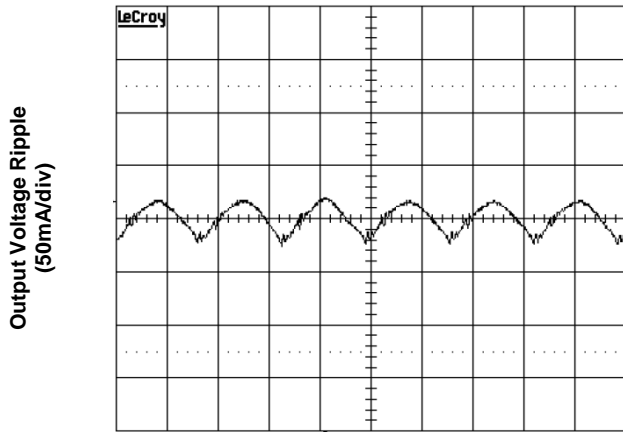
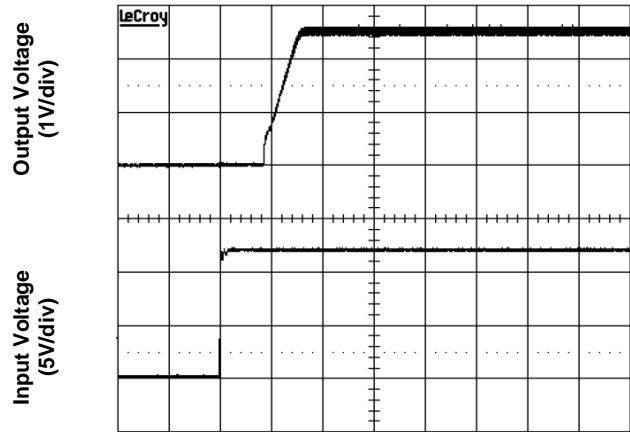

Figure 4b. Current Derating Curve
 ($V_{in}=12V$, open frame)



Time – t (2 μ s/div)
Figure 4c. Output Ripple Voltage ($V_{in}=12V$, full load)



Time – t (2ms/div)
Figure 4d. Output Ripple Voltage ($V_{in}=12V$, full load)

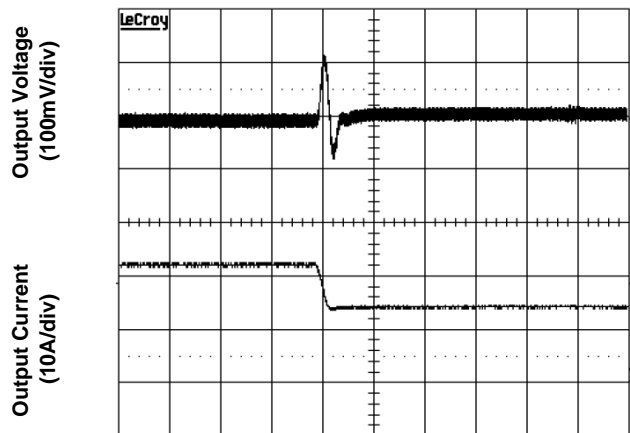
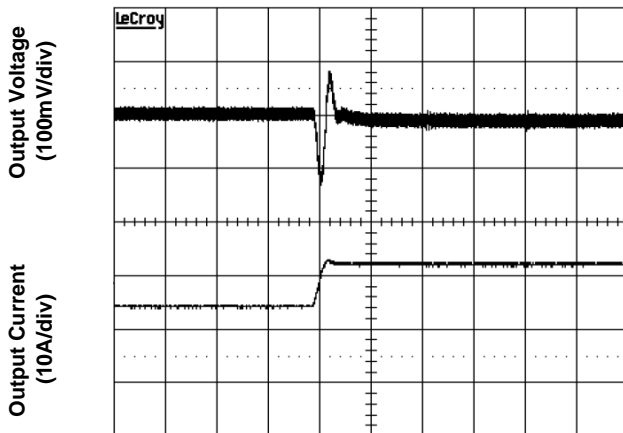

Time – t (200 μ s/div)
Figure 4e. Transient Load Response
(typical V_{in} , load current steps from 50% to 75% at a slew rate 0.1A/ μ s)

Time – t (200 μ s/div)
Figure 4f. Transient Load Response
(typical V_{in} , load current steps from 75% to 50% at a slew rate 0.1A/ μ s)

Characteristic Curves ($V_o=3.3V$)

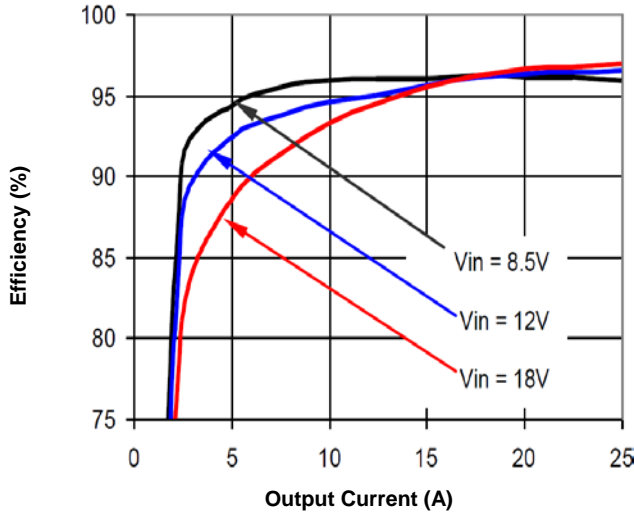

Figure 5a. Efficiency vs. Load Current (25°C)

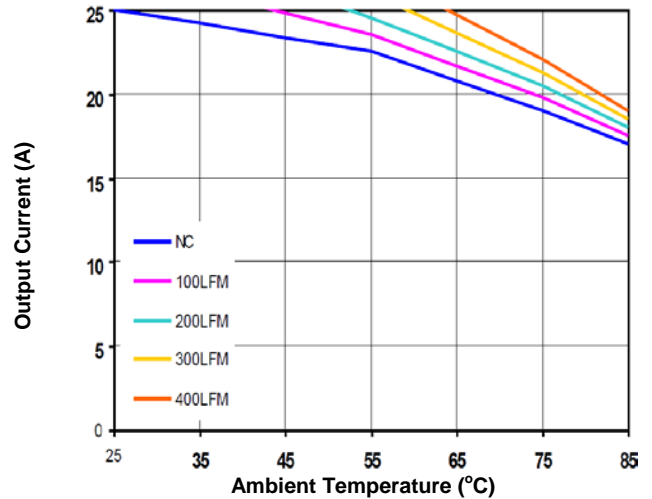
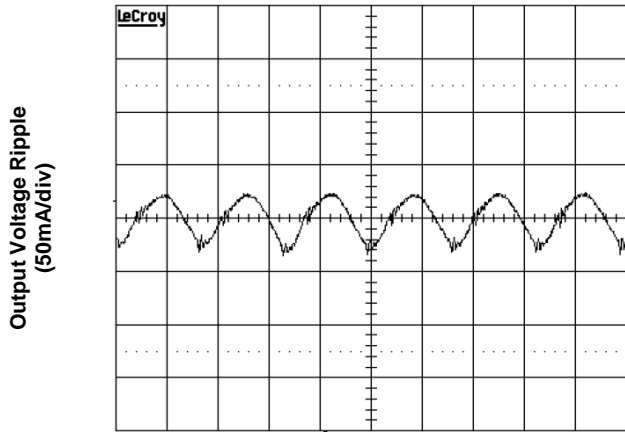
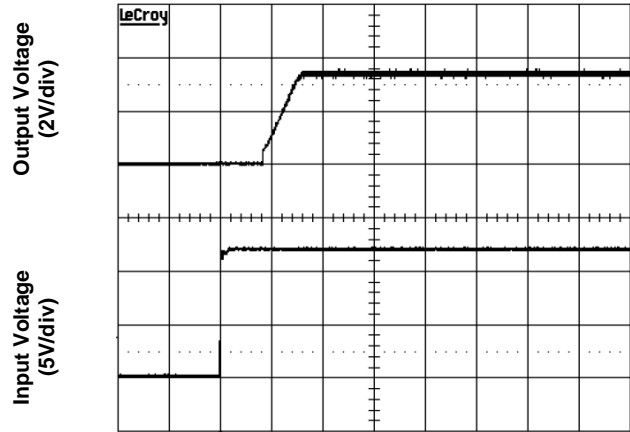

Figure 5b. Current Derating Curve
($V_{in}=12V$, open frame)



Time – t (2 μ s/div)
Figure 5c. Output Ripple Voltage ($V_{in}=12V$, full load)



Time – t (2ms/div)
Figure 5d. Output Ripple Voltage ($V_{in}=12V$, full load)

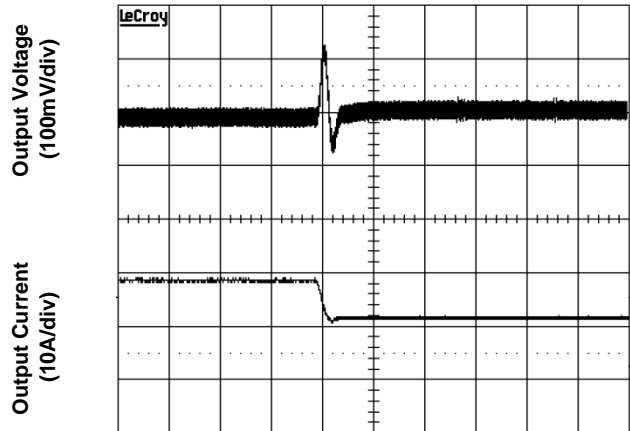
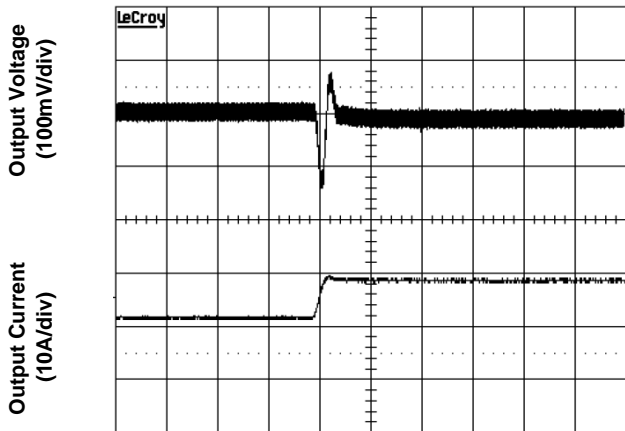

Time – t (200 μ s/div)
Figure 5e. Transient Load Response
(typical V_{in} , load current steps from 50% to 75% at a slew rate 0.1A/ μ s)

Time – t (200 μ s/div)
Figure 5f. Transient Load Response
(typical V_{in} , load current steps from 75% to 50% at a slew rate 0.1A/ μ s)

Characteristic Curves ($V_o=5V$)

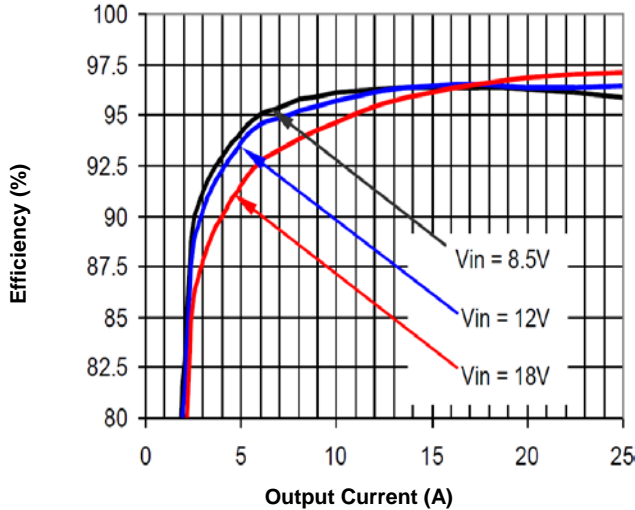

Figure 6a. Efficiency vs. Load Current (25°C)

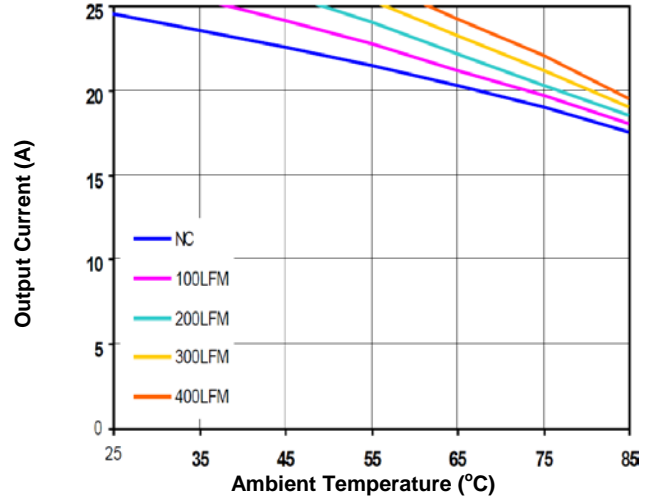
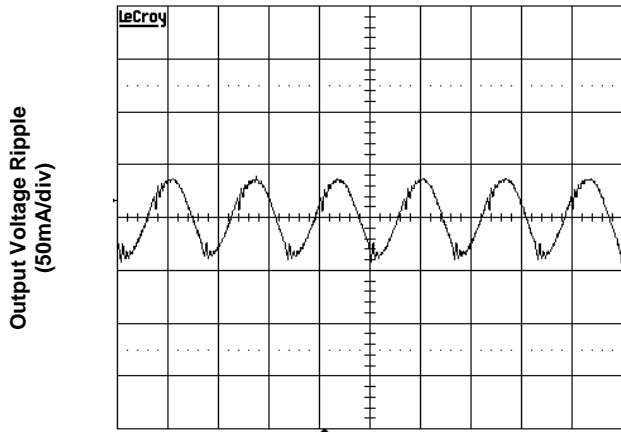
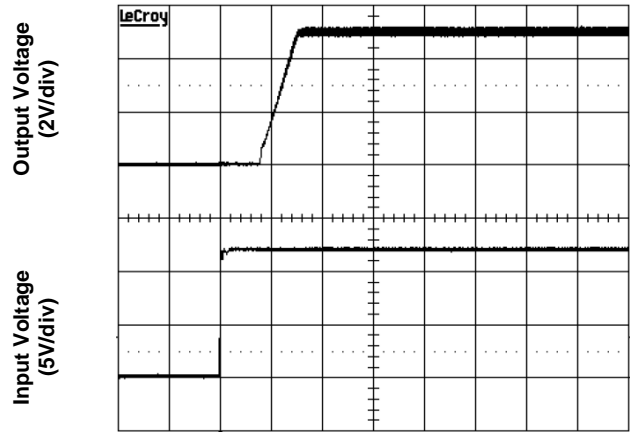

Figure 6b. Current Derating Curve
($V_{in}=12V$, open frame)



Time – t (2 μ s/div)
Figure 6c. Output Ripple Voltage ($V_{in}=12V$, full load)



Time – t (2ms/div)
Figure 6d. Output Ripple Voltage ($V_{in}=12V$, full load)

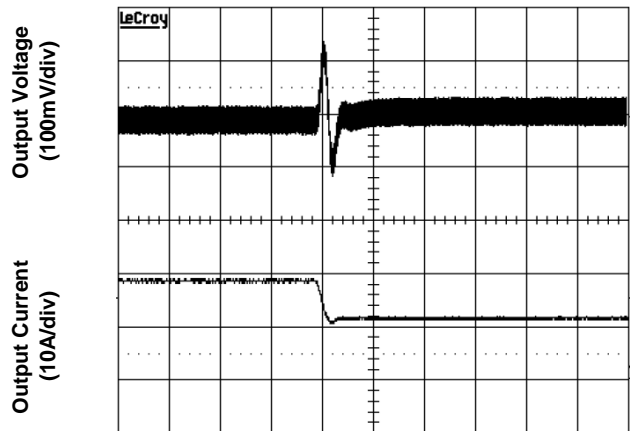
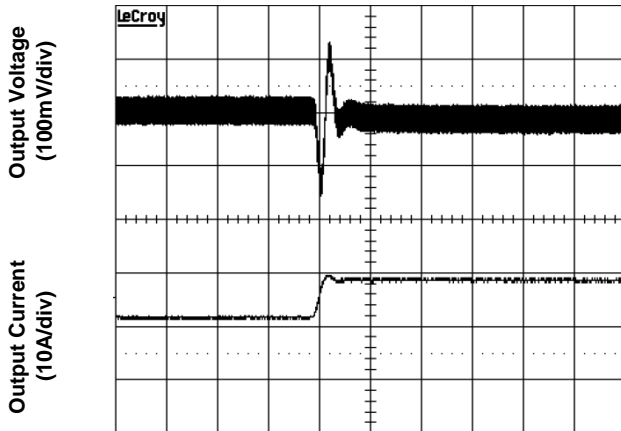



Time – t (200 μ s/div)

Figure 6e. Transient Load Response
(typical V_{in} , load current steps from 50% to 75% at a slew rate 0.1A/ μ s)

Time – t (200 μ s/div)

Figure 6f. Transient Load Response
(typical V_{in} , load current steps from 75% to 50% at a slew rate 0.1A/ μ s)

Feature Descriptions

Remote ON/OFF

The converter can be turned on and off by changing the voltage between the ON/OFF pin and GND. The NES series of converters are available with factory selectable positive logic and negative logic.

For the negative control logic, the converter is ON when the ON/OFF pin is at a logic low level and OFF when the ON/OFF pin is at a logic high level. For the positive control logic, the converter is ON when the ON/OFF pin is at a logic high level and OFF when the ON/OFF pin is at a logic low level. The converter is ON no matter what control logic is when ON/OFF pin is left open (unconnected).

Figure 7 is the recommended ON/Off control circuit for positive logic modules, while Figure 8 is for negative logic modules, Recommended value of the pull up resistor $R_{pull-up}$ is 50Kohm. The maximum allowable leakage current from this pin at logic-high level is 20 μ A.

The logic low level is from 0V to 0.5V and the maximum sink current during logic low is 2mA. The external switch must be capable of maintaining a logic-low level while sinking up to this current.

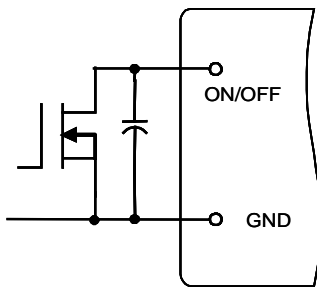

Figure 7. Circuit for Positive Logic Control

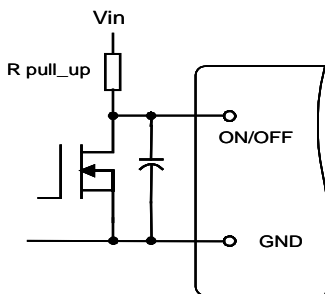

Figure 8. Circuit for Negative Logic Control

Remote SENSE

The remote SENSE pin is used to sense voltage at the load point to accurately regulate the load voltage and eliminate the impact of the voltage drop in the power distribution path.

The SENSE pin should be connected to the point where regulation is desired. The voltage difference between the output pins must not exceed the operating range of this converter shown in the specification table.

When remote sense is not used, the SENSE pin can be connected to the positive output terminals. If the SENSE pins are left floating, the converter will deliver an output voltage slightly higher than its specified typical output voltage.

Because the converter does not have remote sense connection for the return path, it is important to make sure that the connection resistance and voltage drop between GND pin and the load is small.

Output Voltage Programming and Adjustment

This series of converters are available with variable output voltages. The output voltage is preset to 0.8V, and can be programmed up to 5.5V using an external trim resistor connected between the Trim pin and GND pin as shown in Figure 9.

The resistance of the external resistor for trimming up the output voltage can be calculated using the equation below:

$$R_{trim} = \left(\frac{1200}{\Delta} - 100 \right) \Omega$$

Where

$$\Delta = V_o - V_{onom}$$

For variable output models, $V_{onom} = 0.8$

Because this converter uses GND as the reference for control, R_{trim} should be placed as close to GND pin as possible, and the trace connecting GND pin and R_{trim} should not carry significant current, to reduce the effect of voltage drop on the GND trace/plain affecting the output voltage accuracy.

When remote sense and trim functions are used simultaneously, please do not allow the output voltage at the converter output terminals to be outside the operating range.

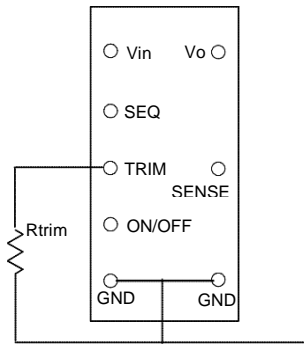

Figure 9. Circuit for Output Voltage Trim

Input Under-Voltage Lockout

This feature prevents the converter from starting until the input voltage reaches the turn-on voltage threshold, and keeps the converter running until the input voltage falls below the turn-off voltage threshold.

Output Over-Current Protection

As a standard feature, the converter turns off when the load current exceeds the current limit. If the over current or short circuit condition persists, the converter will operate in a hiccup mode (repeatedly trying to restart) until the over-current condition is cleared.

Thermal Shutdown

As a standard feature, the converter will shut down if an over-temperature condition is detected. The converter has a temperature sensor, which detects the thermal condition of key components of the converter.

The thermal shutdown circuit is designed to turn the converter off when the temperature at the sensor reaches 120°C. The converter will resume operation after the converter cools down.

Output Over-Voltage Protection

As an optional feature, if the voltage across the output pins exceeds the output voltage protection threshold as shown in the Specifications Table, the converter will clamp the output voltage to protect the converter and the load. The converter automatically resumes normal operation after the over voltage condition is removed.

Output Voltage Tracking / Sequencing

An optional voltage tracking/sequencing feature is available with these converters. This feature is compatible with the “Voltage Sequencing” feature (DOSA) or the “Voltage Tracking” feature (POLA) seen in industry standards.

This feature basically forces the output of the converter to follow the voltage at the SEQ pin until it reaches the set point during startup, or is completely shut down during turn off. The converter’s output voltage is controlled to be the same magnitude as the voltage on the SEQ pin, on a 1:1 basis. When using this function, one should pay careful attention to the following aspects:

- 1). This feature is intended mainly for startup and shutdown sequencing control. In normal operation, the voltage at SEQ pin should be maintained higher than the output voltage set point.
- 2). The input voltage should be valid for this feature to work. During startup, it is recommended to have a delay of at least 10ms between the establishment of a valid input voltage, and the application of a voltage at the SEQ pin.
- 3). The ON/OFF pin should be in “Enabled” state when this function is effective.
- 4). The converter’s pre-bias startup is affected by this function. The converter will still be able to start under a pre-bias condition, but the output voltage waveform will have a glitch during startup if this feature is selected.

Design Considerations

The stability of the NES converters, as with any DC-DC converter, may be compromised if the source impedance is too high or too inductive. It’s desirable to keep the input source AC impedance as low as possible. To reduce switching frequency ripple current getting into the input circuit (especially the ground/return conductor), it is desirable to place some low ESR capacitors at the input of the converter. Due to the existence of some inductance (such as the trace inductance, connector inductance, filter inductance, etc) in the input circuitry, possible oscillation may occur at the input of the converter. Because of the relatively high input current, it may not be practical or economical to have separate damping

or soft start circuit in front of POL converters. A combination of ceramic capacitors and Tantalum/Polymer capacitors are recommended to be used at the input, so the relatively higher ERS of Tantalum/Polymer capacitors can help to damp the possible oscillation.

Similarly, although the converter is designed to be stable without external capacitor at the output, some low ESR capacitors at the output may be desirable to further reduce the output voltage ripple or improve the transient response. A combination of ceramic capacitors and Tantalum/Polymer/Aluminum capacitors usually can achieve good results.

Safety Considerations

The NES Series of converters is designed in accordance with EN 60950 Safety of Information Technology Equipment Including Electrical Equipment. The converters are recognized by UL in both USA and Canada to meet the requirements in UL 60950, Safety of Information Technology Equipment and applicable Canadian Safety Requirement, and ULc 60950. Flammability ratings of the PWB and plastic components in the converter meet UL94V-0.

The converter's output meets SELV requirements if all of its input meets SELV requirements.

Thermal Considerations

The NES converters can operate in various thermal environments. Due to high efficiency and optimal heat distribution, these converters exhibit excellent thermal performance.

The maximum allowable output power of any power converter is usually determined by the electrical design and the maximum operating temperature of its components. The NES converters have been tested comprehensively under various conditions to generate the derating curves with consideration for long term reliability.

Thermal derating curves are highly influenced by derating guideline, the test conditions and setup, such as test temperatures, the interface method between the converter and the test fixture board,

spacing and construction (especially copper weight, holes and openings) of the fixture board and the spacing board, temperature measurement method, and the ambient temperature measurement point. The thermal derating curves in this datasheet are obtained by thermal tests in a wind-tunnel. The converter's power pins are soldered to a 2-layer test fixture board through 18 AWG wires. The space between the test board and a PWB spacing board is 1". Usually, the end system board has more layer count, and has better thermal conductivity than our test fixture board.

Note that the natural convection condition was measured at 0.05 m/s to 0.15 m/s (10ft./min. to 30 ft./min).

Heat Transfer without a Baseplate

Convection heat transfer is the primary cooling means for NES converters. Therefore, airflow speed is important and increasing the airflow over the converter enhances the heat transfer via convection.

The current derating curves for a few output voltages are presented in this datasheet. To maintain long-term reliability, the module should be operated within these curves in steady state.

Proper cooling in the end system can be verified by monitoring the temperature of the key components. Figure 10 shows the recommended temperature monitoring points. The temperature at these locations should not exceed 120 °C continuously.

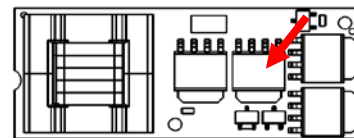
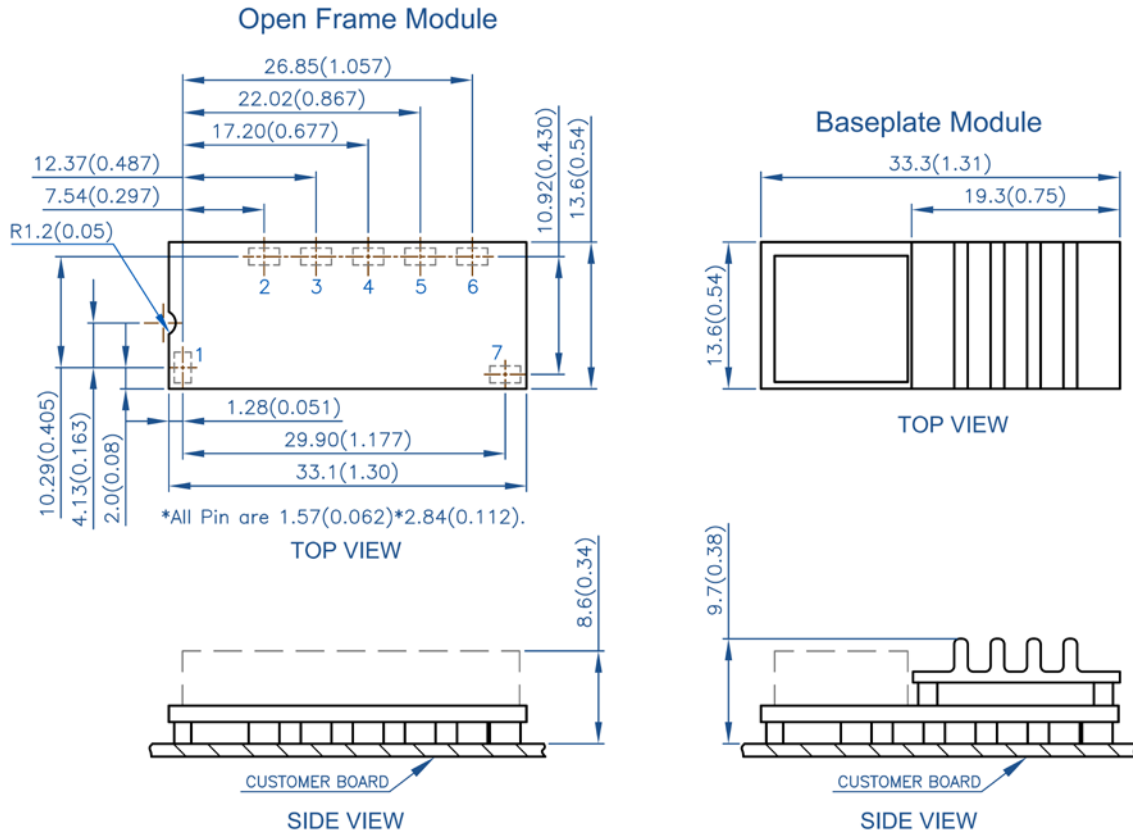

Figure 10. Temperature Monitoring Locations

Heat Transfer with a Baseplate

The NES Series of converters have the options of using a baseplate for enhanced thermal performance.

For reliable operation, the baseplate temperature should not continuously exceed 100 °C.

Mechanical Drawing

Pin	Name	Function
1	ON/OFF	Remote control
2	SENSE	remote sense
3	TRIM	Output voltage adjustment
4	Vout	Output voltage
5	GND	Power ground
6	SEQ	Tracking/Sequencing (optional)
7	Vin	Input voltage

Notes:

- All dimensions in mm (inches)
Tolerances: .x ± .5 (.xx ± 0.02)
.xx ± .25 (.xxx ± 0.010)
- SMT pins are metal block pins at the same locations of the through-hole pins. The recommended diameter for pad/stencil opening and solder mask opening for SMT pins is 3mm (0.12").
- All pins are Copper Alloy, Matte Tin finish with Nickel under plating.
- Weight: 7.5g open frame converter
9.3g baseplate converter
- Workmanship: Meet or exceeds IPC-A-610 Class II.