

Hall ICs

Omnipolar Detection Hall ICs



BU52001GUL, BU52011HFV, BU52021HFV, BU52015GUL, BU52025G, BU52053NVX,
BU52054GWZ, BU52055GWZ, BU52056NVX, BU52061NVX, BD7411G

No.10045EGT02

●Description

The omnipolar Hall ICs are magnetic switches that can operate both S-and N-pole, upon which the output goes from Hi to Low. In addition to regular single-output Hall ICs, We offer a lineup of dual-output units with a reverse output terminal (active High).

●Features

- 1) Omnipolar detection
- 2) Micro power operation (small current using intermittent operation method)(BD7411G is excluded.)
- 3) Ultra-compact and thin wafer level CSP4 package (BU52054GWZ, BU52055GWZ)
- 4) Ultra-compact wafer level CSP4 package (BU52015GUL, BU52001GUL)
- 5) Ultra-Small outline package SSON004X1216 (BU52061NVX, BU52053NVX, BU52056NVX)
- 6) Ultra-Small outline package HVSO5 (BU52011HFV, BU52021HFV)
- 7) Small outline package (BU52025G, BD7411G)
- 8) Line up of supply voltage
 For 1.8V Power supply voltage (BU52054GWZ, BU52055GWZ, BU52015GUL, BU52061NVX, BU52053NVX, BU52056NVX, BU52011HFV)
 For 3.0V Power supply voltage (BU52001GUL)
 For 3.3V Power supply voltage (BU52021HFV, BU52025G)
 For 5.0V Power supply voltage (BD7411G)
- 9) Dual output type (BU52015GUL)
- 10) High ESD resistance 8kV (HBM) (6kV for BU52056NVX)

●Applications

Mobile phones, notebook computers, digital video camera, digital still camera, white goods etc.

●Lineup matrix

| Product name | Supply voltage (V) | Operate point (mT) | Hysteresis (mT) | Period (ms) | Supply current (AVG) (A) | Output type | Package |
|--------------|--------------------|--------------------|-----------------|-------------|--------------------------|-------------|--------------|
| BU52054GWZ | 1.65~3.60 | +/-6.3 * | 0.9 | 50 | 5.0μ | CMOS | UCSP35L1 |
| BU52055GWZ | 1.65~3.60 | +/-4.1 * | 0.8 | 50 | 5.0μ | CMOS | UCSP35L1 |
| BU52015GUL | 1.65~3.30 | +/-3.0 * | 0.9 | 50 | 5.0μ | CMOS | VCSP50L1 |
| BU52001GUL | 2.40~3.30 | +/-3.7 * | 0.8 | 50 | 8.0μ | CMOS | VCSP50L1 |
| BU52061NVX | 1.65~3.60 | +/-3.3 * | 0.9 | 50 | 4.0μ | CMOS | SSON004X1216 |
| BU52053NVX | 1.65~3.60 | +/-3.0 * | 0.9 | 50 | 5.0μ | CMOS | SSON004X1216 |
| BU52056NVX | 1.65~3.60 | +/-4.6 * | 0.8 | 50 | 5.0μ | CMOS | SSON004X1216 |
| BU52011HFV | 1.65~3.30 | +/-3.0 * | 0.9 | 50 | 5.0μ | CMOS | HVSO5 |
| BU52021HFV | 2.40~3.60 | +/-3.7 * | 0.8 | 50 | 8.0μ | CMOS | HVSO5 |
| BU52025G | 2.40~3.60 | +/-3.7 * | 0.8 | 50 | 8.0μ | CMOS | SSOP5 |
| BD7411G | 4.50~5.50 | +/-3.4 * | 0.4 | - | 2.0m | CMOS | SSOP5 |

*Plus is expressed on the S-pole; minus on the N-pole

● Absolute maximum ratings

BU52054GWZ, BU52055GWZ (Ta=25°C)

| Parameter | Symbol | Ratings | Unit |
|-----------------------------|------------------|-------------------------|------|
| Power Supply Voltage | V _{DD} | -0.1~+4.5 ^{※1} | V |
| Output Current | I _{OUT} | ±0.5 | mA |
| Power Dissipation | P _d | 100 ^{※2} | mW |
| Operating Temperature Range | T _{opr} | -40~+85 | °C |
| Storage Temperature Range | T _{stg} | -40~+125 | °C |

※1. Not to exceed Pd

※2. Reduced by 1.00mW for each increase in Ta of 1°C over 25°C (mounted on 24mm × 20mm Glass-epoxy PCB)

BU52015GUL (Ta=25°C)

| Parameter | Symbol | Ratings | Unit |
|-----------------------------|------------------|-------------------------|------|
| Power Supply Voltage | V _{DD} | -0.1~+4.5 ^{※3} | V |
| Output Current | I _{OUT} | ±0.5 | mA |
| Power Dissipation | P _d | 420 ^{※4} | mW |
| Operating Temperature Range | T _{opr} | -40~+85 | °C |
| Storage Temperature Range | T _{stg} | -40~+125 | °C |

※3. Not to exceed Pd

※4. Reduced by 4.20mW for each increase in Ta of 1°C over 25°C (mounted on 50mm × 58mm Glass-epoxy PCB)

BU52001GUL (Ta=25°C)

| Parameter | Symbol | Ratings | Unit |
|-----------------------------|------------------|-------------------------|------|
| Power Supply Voltage | V _{DD} | -0.1~+4.5 ^{※5} | V |
| Output Current | I _{OUT} | ±1 | mA |
| Power Dissipation | P _d | 420 ^{※6} | mW |
| Operating Temperature Range | T _{opr} | -40~+85 | °C |
| Storage Temperature Range | T _{stg} | -40~+125 | °C |

※5. Not to exceed Pd

※6. Reduced by 4.20mW for each increase in Ta of 1°C over 25°C (mounted on 50mm × 58mm Glass-epoxy PCB)

BU52061NVX, BU52053NVX, BU52056NVX(Ta=25°C)

| Parameter | Symbol | Ratings | Unit |
|-----------------------------|------------------|-------------------------|------|
| Power Supply Voltage | V _{DD} | -0.1~+4.5 ^{※7} | V |
| Output Current | I _{OUT} | ±0.5 | mA |
| Power Dissipation | P _d | 2049 ^{※8} | mW |
| Operating Temperature Range | T _{opr} | -40~+85 | °C |
| Storage Temperature Range | T _{stg} | -40~+125 | °C |

※7. Not to exceed Pd

※8. Reduced by 4.20mW for each increase in Ta of 1°C over 25°C (mounted on 50mm × 58mm Glass-epoxy PCB)

BU52011HFV (Ta=25°C)

| Parameter | Symbol | Ratings | Unit |
|-----------------------------|------------------|-------------------------|------|
| Power Supply Voltage | V _{DD} | -0.1~+4.5 ^{※9} | V |
| Output Current | I _{OUT} | ±0.5 | mA |
| Power Dissipation | P _d | 536 ^{※10} | mW |
| Operating Temperature Range | T _{opr} | -40~+85 | °C |
| Storage Temperature Range | T _{stg} | -40~+125 | °C |

※9. Not to exceed Pd

※10. Reduced by 5.36mW for each increase in Ta of 1°C over 25°C (mounted on 70mm × 70 mm × 1.6mm Glass-epoxy PCB)

BU52021HFV (Ta=25°C)

| Parameter | Symbol | Ratings | Unit |
|-----------------------------|------------------|--------------------------|------|
| Power Supply Voltage | V _{DD} | -0.1~+4.5 ^{※11} | V |
| Output Current | I _{OUT} | ±1 | mA |
| Power Dissipation | P _d | 536 ^{※12} | mW |
| Operating Temperature Range | T _{opr} | -40~+85 | °C |
| Storage Temperature Range | T _{stg} | -40~+125 | °C |

※11 Not to exceed Pd

※12. Reduced by 5.36mW for each increase in Ta of 1°C over 25°C (mounted on 70mm × 70 mm × 1.6mm Glass-epoxy PCB)

BU52025G (Ta=25°C)

| Parameter | Symbol | Ratings | Unit |
|-----------------------------|------------------|--------------------------|------|
| Power Supply Voltage | V _{DD} | -0.1~+4.5 ^{※13} | V |
| Output Current | I _{OUT} | ±1 | mA |
| Power Dissipation | P _d | 540 ^{※14} | mW |
| Operating Temperature Range | T _{opr} | -40~+85 | °C |
| Storage Temperature Range | T _{stg} | -40~+125 | °C |

※13. Not to exceed Pd

※14. Reduced by 5.40mW for each increase in Ta of 1°C over 25°C (mounted on 70mm × 70 mm × 1.6mm Glass-epoxy PCB)

BD7411G (Ta=25°C)

| Parameter | Symbol | Ratings | Unit |
|-----------------------------|------------------|--------------------------|------|
| Power Supply Voltage | V _{DD} | -0.3~+7.0 ^{※15} | V |
| Output Current | I _{OUT} | ±1 | mA |
| Power Dissipation | P _d | 540 ^{※16} | mW |
| Operating Temperature Range | T _{opr} | -40~+85 | °C |
| Storage Temperature Range | T _{stg} | -55~+150 | °C |

※15. Not to exceed Pd

※16. Reduced by 5.40mW for each increase in Ta of 1°C over 25°C (mounted on 70mm × 70 mm × 1.6mm Glass-epoxy PCB)

●Magnetic, Electrical characteristics

BU52054GWZ (Unless otherwise specified, $V_{DD}=1.80V$, $T_a=25^{\circ}C$)

| Parameter | Symbol | Limits | | | Unit | Conditions |
|------------------------------------|---------------|--------------|------|------|---------|---|
| | | Min. | Typ. | Max. | | |
| Power Supply Voltage | V_{DD} | 1.65 | 1.80 | 3.60 | V | |
| Operate Point | B_{opS} | - | 6.3 | 7.9 | mT | |
| | B_{opN} | -7.9 | -6.3 | - | | |
| Release Point | B_{rpS} | 3.5 | 5.4 | - | mT | |
| | B_{rpN} | - | -5.4 | -3.5 | | |
| Hysteresis | B_{hysS} | - | 0.9 | - | mT | |
| | B_{hysN} | - | 0.9 | - | | |
| Period | T_p | - | 50 | 100 | ms | |
| Output High Voltage | V_{OH} | $V_{DD}-0.2$ | - | - | V | $B_{rpN} < B < B_{rpS}$ $I_{OUT} = -0.5mA$ ※17 |
| Output Low Voltage | V_{OL} | - | - | 0.2 | V | $B < B_{opN}$, $B_{opS} < B$ $I_{OUT} = +0.5mA$ ※17 |
| Supply Current | $I_{DD(AVG)}$ | - | 5 | 8 | μA | Average |
| Supply Current During Startup Time | $I_{DD(EN)}$ | - | 2.8 | - | mA | During Startup Time Value |
| Supply Current During Standby Time | $I_{DD(DIS)}$ | - | 1.8 | - | μA | During Standby Time Value |

※17 B = Magnetic flux density
 1mT=10Gauss

Positive (“+”) polarity flux is defined as the magnetic flux from south pole which is direct toward to the branded face of the sensor.

After applying power supply, it takes one cycle of period (T_p) to become definite output.

Radiation hardness is not designed.

BU52055GWZ (Unless otherwise specified, $V_{DD}=1.80V$, $T_a=25^{\circ}C$)

| Parameter | Symbol | Limits | | | Unit | Conditions |
|------------------------------------|---------------|--------------|------|------|---------|---|
| | | Min. | Typ. | Max. | | |
| Power Supply Voltage | V_{DD} | 1.65 | 1.80 | 3.60 | V | |
| Operate Point | B_{opS} | - | 4.1 | 5.5 | mT | |
| | B_{opN} | -5.5 | -4.1 | - | | |
| Release Point | B_{rpS} | 1.5 | 3.3 | - | mT | |
| | B_{rpN} | - | -3.3 | -1.5 | | |
| Hysteresis | B_{hysS} | - | 0.8 | - | mT | |
| | B_{hysN} | - | 0.8 | - | | |
| Period | T_p | - | 50 | 100 | ms | |
| Output High Voltage | V_{OH} | $V_{DD}-0.2$ | - | - | V | $B_{rpN} < B < B_{rpS}$ $I_{OUT} = -0.5mA$ ※18 |
| Output Low Voltage | V_{OL} | - | - | 0.2 | V | $B < B_{opN}$, $B_{opS} < B$ $I_{OUT} = +0.5mA$ ※18 |
| Supply Current | $I_{DD(AVG)}$ | - | 5 | 8 | μA | Average |
| Supply Current During Startup Time | $I_{DD(EN)}$ | - | 2.8 | - | mA | During Startup Time Value |
| Supply Current During Standby Time | $I_{DD(DIS)}$ | - | 1.8 | - | μA | During Standby Time Value |

※18 B = Magnetic flux density

1mT=10Gauss

Positive (“+”) polarity flux is defined as the magnetic flux from south pole which is direct toward to the branded face of the sensor.

After applying power supply, it takes one cycle of period (T_p) to become definite output.

Radiation hardness is not designed.

BU52015GUL (Unless otherwise specified, $V_{DD}=1.80V$, $T_a=25^{\circ}C$)

| Parameter | Symbol | Limits | | | Unit | Conditions |
|--------------------------------------|----------------|--------------|------|------|---------|--|
| | | Min. | Typ. | Max. | | |
| Power Supply Voltage | V_{DD} | 1.65 | 1.80 | 3.30 | V | |
| Operate Point | B_{opS} | - | 3.0 | 5.0 | mT | |
| | B_{opN} | -5.0 | -3.0 | - | | |
| Release Point | B_{rpS} | 0.6 | 2.1 | - | mT | |
| | B_{rpN} | - | -2.1 | -0.6 | | |
| Hysteresis | B_{hysS} | - | 0.9 | - | mT | |
| | B_{hysN} | - | 0.9 | - | | |
| Period | T_p | - | 50 | 100 | ms | |
| Output High Voltage | V_{OH} | $V_{DD}-0.2$ | - | - | V | OUT1: $B_{rpN} < B < B_{rpS}$ ※19 OUT2: $B < B_{opN}$, $B_{opS} < B$ $I_{OUT} = -0.5mA$ |
| Output Low Voltage | V_{OL} | - | - | 0.2 | V | OUT1: $B < B_{opN}$, $B_{opS} < B$ ※19 OUT2: $B_{rpN} < B < B_{rpS}$ $I_{OUT} = +0.5mA$ |
| Supply Current 1 | $I_{DD1(AVG)}$ | - | 5 | 8 | μA | $V_{DD}=1.8V$, Average |
| Supply Current During Startup Time 1 | $I_{DD1(EN)}$ | - | 2.8 | - | mA | $V_{DD}=1.8V$, During Startup Time Value |
| Supply Current During Standby Time 1 | $I_{DD1(DIS)}$ | - | 1.8 | - | μA | $V_{DD}=1.8V$, During Standby Time Value |
| Supply Current 2 | $I_{DD2(AVG)}$ | - | 8 | 12 | μA | $V_{DD}=2.7V$, Average |
| Supply Current During Startup Time 2 | $I_{DD2(EN)}$ | - | 4.5 | - | mA | $V_{DD}=2.7V$, During Startup Time Value |
| Supply Current During Standby Time 2 | $I_{DD2(DIS)}$ | - | 4.0 | - | μA | $V_{DD}=2.7V$, During Standby Time Value |

※19 B = Magnetic flux density
 1mT=10Gauss

Positive (“+”) polarity flux is defined as the magnetic flux from south pole which is direct toward to the branded face of the sensor.

After applying power supply, it takes one cycle of period (T_p) to become definite output.

Radiation hardness is not designed.

BU52001GUL (Unless otherwise specified, $V_{DD}=3.0V$, $T_a=25^{\circ}C$)

| Parameter | Symbol | Limits | | | Unit | Conditions |
|------------------------------------|---------------|--------------|------|------|---------|--|
| | | Min. | Typ. | Max. | | |
| Power Supply Voltage | V_{DD} | 2.4 | 3.0 | 3.3 | V | |
| Operate Point | B_{opS} | - | 3.7 | 5.5 | mT | |
| | B_{opN} | -5.5 | -3.7 | - | | |
| Release Point | B_{rpS} | 0.8 | 2.9 | - | mT | |
| | B_{rpN} | - | -2.9 | -0.8 | | |
| Hysteresis | B_{hysS} | - | 0.8 | - | mT | |
| | B_{hysN} | - | 0.8 | - | | |
| Period | T_p | - | 50 | 100 | ms | |
| Output High Voltage | V_{OH} | $V_{DD}-0.4$ | - | - | V | $B_{rpN} < B < B_{rpS}$ $I_{OUT} = -1.0mA$ ※20 |
| Output Low Voltage | V_{OL} | - | - | 0.4 | V | $B < B_{opN}, B_{opS} < B$ $I_{OUT} = +1.0mA$ ※20 |
| Supply Current | $I_{DD(AVG)}$ | - | 8 | 12 | μA | Average |
| Supply Current During Startup Time | $I_{DD(EN)}$ | - | 4.7 | - | mA | During Startup Time Value |
| Supply Current During Standby Time | $I_{DD(DIS)}$ | - | 3.8 | - | μA | During Standby Time Value |

※20 B = Magnetic flux density
 1mT=10Gauss

Positive (“+”) polarity flux is defined as the magnetic flux from south pole which is direct toward to the branded face of the sensor.
 After applying power supply, it takes one cycle of period (T_p) to become definite output.
 Radiation hardness is not designed.

BU52061NVX (Unless otherwise specified, $V_{DD}=1.80V$, $T_a=25^{\circ}C$)

| Parameter | Symbol | Limits | | | Unit | Conditions |
|--------------------------------------|----------------|--------------|------|------|---------|---|
| | | Min. | Typ. | Max. | | |
| Power Supply Voltage | V_{DD} | 1.65 | 1.80 | 3.60 | V | |
| Operate Point | B_{opS} | 2.3 | 3.3 | 4.7 | mT | |
| | B_{opN} | -4.7 | -3.3 | -2.3 | | |
| Release Point | B_{rpS} | 1.2 | 2.4 | 3.4 | mT | |
| | B_{rpN} | -3.4 | -2.4 | -1.2 | | |
| Hysteresis | B_{hysS} | - | 0.9 | - | mT | |
| | B_{hysN} | - | 0.9 | - | | |
| Period | T_p | - | 50 | 100 | ms | |
| Output High Voltage | V_{OH} | $V_{DD}-0.2$ | - | - | V | $B_{rpN} < B < B_{rpS}$ $I_{OUT} = -0.5mA$ ※21 |
| Output Low Voltage | V_{OL} | - | - | 0.2 | V | $B < B_{opN}$, $B_{opS} < B$ $I_{OUT} = +0.5mA$ ※21 |
| Supply Current 1 | $I_{DD1(AVG)}$ | - | 4 | 7 | μA | $V_{DD}=1.8V$, Average |
| Supply Current During Startup Time 1 | $I_{DD1(EN)}$ | - | 5.0 | - | mA | $V_{DD}=1.8V$, During Startup Time Value |
| Supply Current During Standby Time 1 | $I_{DD1(DIS)}$ | - | 1.8 | - | μA | $V_{DD}=1.8V$, During Standby Time Value |
| Supply Current 2 | $I_{DD2(AVG)}$ | - | 9 | 16 | μA | $V_{DD}=3.0V$, Average |
| Supply Current During Startup Time 2 | $I_{DD2(EN)}$ | - | 9.0 | - | mA | $V_{DD}=3.0V$, During Startup Time Value |
| Supply Current During Standby Time 2 | $I_{DD2(DIS)}$ | - | 4.4 | - | μA | $V_{DD}=3.0V$, During Standby Time Value |

※21 B = Magnetic flux density
 1mT=10Gauss

Positive (“+”) polarity flux is defined as the magnetic flux from south pole which is direct toward to the branded face of the sensor.

After applying power supply, it takes one cycle of period (T_p) to become definite output.

Radiation hardness is not designed.

BU52053NVX (Unless otherwise specified, $V_{DD}=1.80V$, $T_a=25^{\circ}C$)

| Parameter | Symbol | Limits | | | Unit | Conditions |
|------------------------------------|---------------|--------------|------|------|---------|---|
| | | Min. | Typ. | Max. | | |
| Power Supply Voltage | V_{DD} | 1.65 | 1.80 | 3.60 | V | |
| Operate Point | B_{opS} | - | 3.0 | 5.0 | mT | |
| | B_{opN} | -5.0 | -3.0 | - | | |
| Release Point | B_{rpS} | 0.6 | 2.1 | - | mT | |
| | B_{rpN} | - | -2.1 | -0.6 | | |
| Hysteresis | B_{hysS} | - | 0.9 | - | mT | |
| | B_{hysN} | - | 0.9 | - | | |
| Period | T_p | - | 50 | 100 | ms | |
| Output High Voltage | V_{OH} | $V_{DD}-0.2$ | - | - | V | $B_{rpN} < B < B_{rpS}$ $I_{OUT} = -0.5mA$ ※22 |
| Output Low Voltage | V_{OL} | - | - | 0.2 | V | $B < B_{opN}$, $B_{opS} < B$ $I_{OUT} = +0.5mA$ ※22 |
| Supply Current | $I_{DD(AVG)}$ | - | 5 | 8 | μA | Average |
| Supply Current During Startup Time | $I_{DD(EN)}$ | - | 2.8 | - | mA | During Startup Time Value |
| Supply Current During Standby Time | $I_{DD(DIS)}$ | - | 1.8 | - | μA | During Standby Time Value |

※22 B = Magnetic flux density

1mT=10Gauss

Positive (“+”) polarity flux is defined as the magnetic flux from south pole which is direct toward to the branded face of the sensor.

After applying power supply, it takes one cycle of period (T_p) to become definite output.

Radiation hardness is not designed.

BU52011HFV (Unless otherwise specified, $V_{DD}=1.80V$, $T_a=25^{\circ}C$)

| Parameter | Symbol | Limits | | | Unit | Conditions |
|--------------------------------------|----------------|--------------|------|------|---------|---|
| | | Min. | Typ. | Max. | | |
| Power Supply Voltage | V_{DD} | 1.65 | 1.80 | 3.30 | V | |
| Operate Point | B_{opS} | - | 3.0 | 5.0 | mT | |
| | B_{opN} | -5.0 | -3.0 | - | | |
| Release Point | B_{rpS} | 0.6 | 2.1 | - | mT | |
| | B_{rpN} | - | -2.1 | -0.6 | | |
| Hysteresis | B_{hysS} | - | 0.9 | - | mT | |
| | B_{hysN} | - | 0.9 | - | | |
| Period | T_p | - | 50 | 100 | ms | |
| Output High Voltage | V_{OH} | $V_{DD}-0.2$ | - | - | V | $B_{rpN} < B < B_{rpS}$ $I_{OUT} = -0.5mA$ ※23 |
| Output Low Voltage | V_{OL} | - | - | 0.2 | V | $B < B_{opN}$, $B_{opS} < B$ $I_{OUT} = +0.5mA$ ※23 |
| Supply Current 1 | $I_{DD1(AVG)}$ | - | 5 | 8 | μA | $V_{DD}=1.8V$, Average |
| Supply Current During Startup Time 1 | $I_{DD1(EN)}$ | - | 2.8 | - | mA | $V_{DD}=1.8V$, During Startup Time Value |
| Supply Current During Standby Time 1 | $I_{DD1(DIS)}$ | - | 1.8 | - | μA | $V_{DD}=1.8V$, During Standby Time Value |
| Supply Current 2 | $I_{DD2(AVG)}$ | - | 8 | 12 | μA | $V_{DD}=2.7V$, Average |
| Supply Current During Startup Time 2 | $I_{DD2(EN)}$ | - | 4.5 | - | mA | $V_{DD}=2.7V$, During Startup Time Value |
| Supply Current During Standby Time 2 | $I_{DD2(DIS)}$ | - | 4.0 | - | μA | $V_{DD}=2.7V$, During Standby Time Value |

※23 B = Magnetic flux density
 1mT=10Gauss

Positive (“+”) polarity flux is defined as the magnetic flux from south pole which is direct toward to the branded face of the sensor.

After applying power supply, it takes one cycle of period (T_p) to become definite output.

Radiation hardness is not designed.

BU52056NVX (Unless otherwise specified, $V_{DD}=1.80V$, $T_a=25^{\circ}C$)

| Parameter | Symbol | Limits | | | Unit | Conditions |
|------------------------------------|---------------|--------------|------|------|---------|---|
| | | Min. | Typ. | Max. | | |
| Power Supply Voltage | V_{DD} | 1.65 | 1.80 | 3.60 | V | |
| Operate Point | B_{opS} | - | 4.6 | 6.4 | mT | |
| | B_{opN} | -6.4 | -4.6 | - | | |
| Release Point | B_{rpS} | 2.0 | 3.8 | - | mT | |
| | B_{rpN} | - | -3.8 | -2.0 | | |
| Hysteresis | B_{hysS} | - | 0.8 | - | mT | |
| | B_{hysN} | - | 0.8 | - | | |
| Period | T_p | - | 50 | 100 | ms | |
| Output High Voltage | V_{OH} | $V_{DD}-0.2$ | - | - | V | $B_{rpN} < B < B_{rpS}$ $I_{OUT} = -0.5mA$ ※24 |
| Output Low Voltage | V_{OL} | - | - | 0.2 | V | $B < B_{opN}$, $B_{opS} < B$ $I_{OUT} = +0.5mA$ ※24 |
| Supply Current | $I_{DD(AVG)}$ | - | 5 | 8 | μA | Average |
| Supply Current During Startup Time | $I_{DD(EN)}$ | - | 2.8 | - | mA | During Startup Time Value |
| Supply Current During Standby Time | $I_{DD(DIS)}$ | - | 1.8 | - | μA | During Standby Time Value |

※24 B = Magnetic flux density

1mT=10Gauss

Positive (“+”) polarity flux is defined as the magnetic flux from south pole which is direct toward to the branded face of the sensor.

After applying power supply, it takes one cycle of period (T_p) to become definite output.

Radiation hardness is not designed.

BU52021HFV, BU52025G (Unless otherwise specified, $V_{DD}=3.0V$, $T_a=25^{\circ}C$)

| Parameter | Symbol | Limits | | | Unit | Conditions |
|------------------------------------|---------------|--------------|------|------|---------|---|
| | | Min. | Typ. | Max. | | |
| Power Supply Voltage | V_{DD} | 2.4 | 3.0 | 3.6 | V | |
| Operate Point | B_{opS} | - | 3.7 | 5.5 | mT | |
| | B_{opN} | -5.5 | -3.7 | - | | |
| Release Point | B_{rpS} | 0.8 | 2.9 | - | mT | |
| | B_{rpN} | - | -2.9 | -0.8 | | |
| Hysteresis | B_{hysS} | - | 0.8 | - | mT | |
| | B_{hysN} | - | 0.8 | - | | |
| Period | T_p | - | 50 | 100 | ms | |
| Output High Voltage | V_{OH} | $V_{DD}-0.4$ | - | - | V | $B_{rpN} < B < B_{rpS}$ $I_{OUT} = -1.0mA$ ※25 |
| Output Low Voltage | V_{OL} | - | - | 0.4 | V | $B < B_{opN}$, $B_{opS} < B$ $I_{OUT} = +1.0mA$ ※25 |
| Supply Current | $I_{DD(AVG)}$ | - | 8 | 12 | μA | Average |
| Supply Current During Startup Time | $I_{DD(EN)}$ | - | 4.7 | - | mA | During Startup Time Value |
| Supply Current During Standby Time | $I_{DD(DIS)}$ | - | 3.8 | - | μA | During Standby Time Value |

※25 B = Magnetic flux density
 1mT=10Gauss

Positive (“+”) polarity flux is defined as the magnetic flux from south pole which is direct toward to the branded face of the sensor.

After applying power supply, it takes one cycle of period (T_p) to become definite output.

Radiation hardness is not designed.

BD7411G (Unless otherwise specified, $V_{DD}=5.0V$, $T_a=25^{\circ}C$)

| Parameter | Symbol | Limits | | | Unit | Conditions |
|----------------------|------------|--------|------|------|------|---|
| | | Min. | Typ. | Max. | | |
| Power Supply Voltage | V_{DD} | 4.5 | 5.0 | 5.5 | V | |
| Operate Point | B_{opS} | - | 3.4 | 5.6 | mT | |
| | B_{opN} | -5.6 | -3.4 | - | | |
| Release Point | B_{rpS} | 1.5 | 3.0 | - | mT | |
| | B_{rpN} | - | -3.0 | -1.5 | | |
| Hysteresis | B_{hysS} | - | 0.4 | - | mT | |
| | B_{hysN} | - | 0.4 | - | | |
| Output High Voltage | V_{OH} | 4.6 | - | - | V | $B_{rpN} < B < B_{rpS}$ $I_{OUT} = -1.0mA$ ※26 |
| Output Low Voltage | V_{OL} | - | - | 0.4 | V | $B < B_{opN}$, $B_{opS} < B$ $I_{OUT} = +1.0mA$ ※26 |
| Supply Current | I_{DD} | - | 2 | 4 | mA | |

※26 B = Magnetic flux density

1mT=10Gauss

Positive (“+”) polarity flux is defined as the magnetic flux from south pole which is direct toward to the branded face of the sensor.

Radiation hardness is not designed.

● Figure of measurement circuit

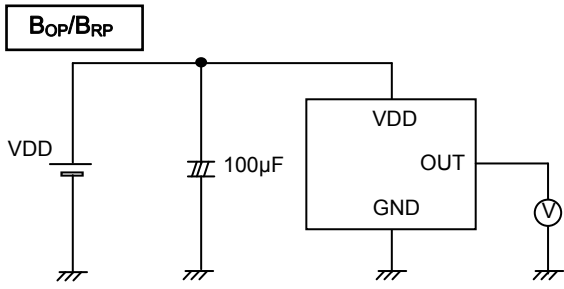

Bop and Brp are measured with applying the magnetic field from the outside.

Fig.1 B_{op}, B_{rp} measurement circuit

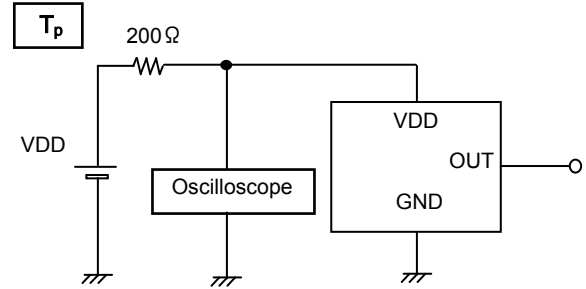

The period is monitored by Oscilloscope.

Fig.2 T_p measurement circuit

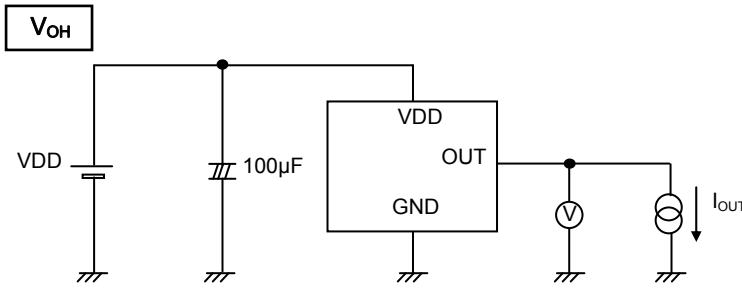

Fig.3 V_{OH} measurement circuit

| Product Name | I _{OUT} |
|---|------------------|
| BU52001GUL, BU52021HFV, BU52025G, BD7411G | 1.0mA |
| BU52054GWZ, BU52055GWZ, BU52015GUL, BU52061NVX, BU52053NVX, BU52056NVX, BU52011HFV | 0.5mA |

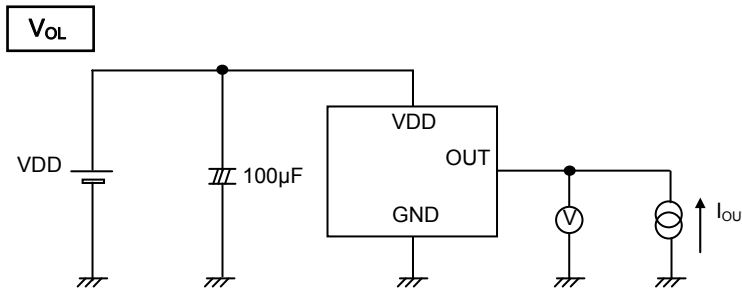

Fig.4 V_{OL} measurement circuit

| Product Name | I _{OUT} |
|---|------------------|
| BU52001GUL, BU52021HFV, BU52025G, BD7411G | 1.0mA |
| BU52054GWZ, BU52055GWZ, BU52015GUL, BU52061NVX, BU52053NVX, BU52056NVX, BU52011HFV | 0.5mA |

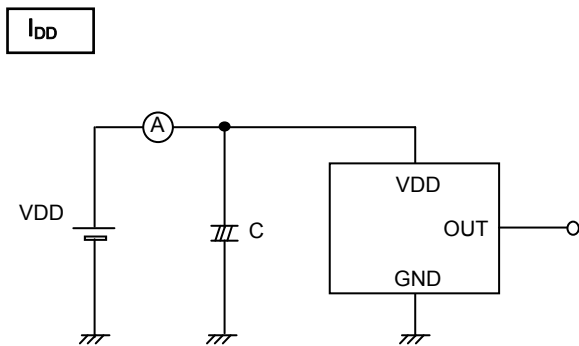

Fig.5 I_{DD} measurement circuit

| Product Name | C |
|--|--------|
| BU52054GWZ, BU52055GWZ, BU52015GUL, BU52001GUL, BU52061NVX, BU52053NVX, BU52056NVX, BU52011HFV, BU52021HFV, BU52025G | 2200µF |
| BD7411G | 100µF |

● Technical (Reference) Data

BU52054GWZ (V_{DD}=1.65~3.6V type)

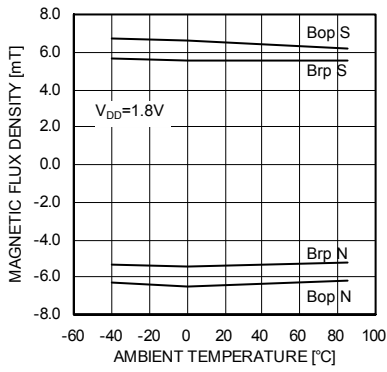

Fig. 6 Bop, Brp– Ambient temperature

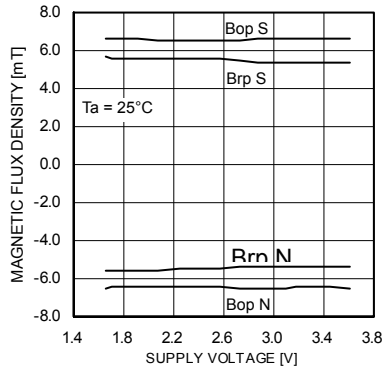

Fig. 7 Bop, Brp– Supply voltage

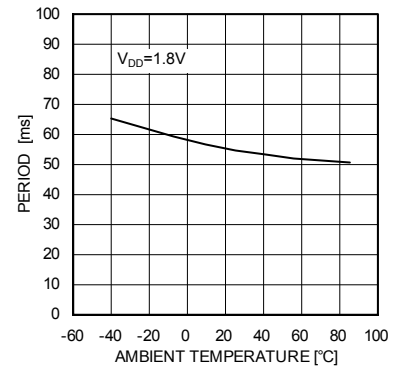

Fig. 8 T_P– Ambient temperature

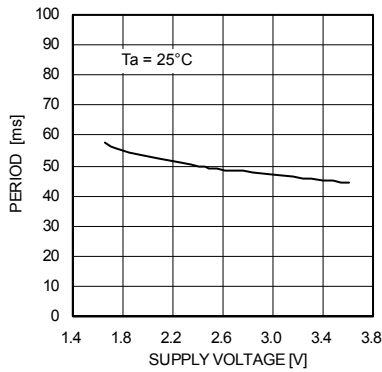

Fig. 9 T_P– Supply voltage

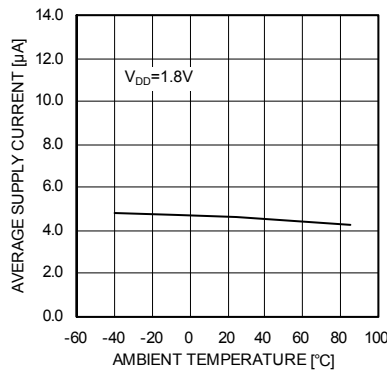

Fig. 10 I_{DD}– Ambient temperature

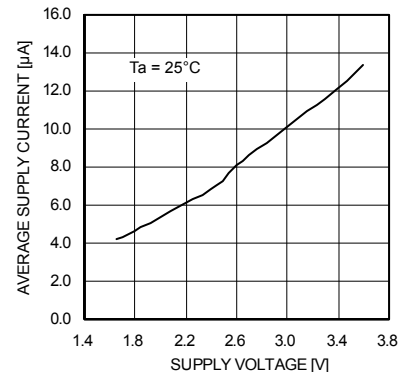

Fig. 11 I_{DD}– Supply voltage

BU52055GWZ (V_{DD}=1.65~3.6V type)

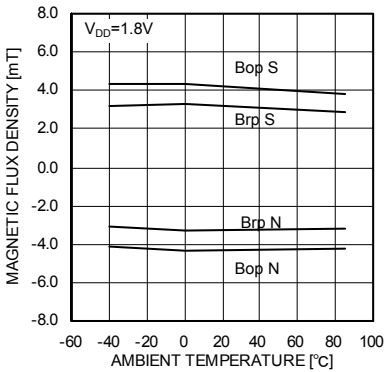

Fig. 12 Bop, Brp– Ambient temperature

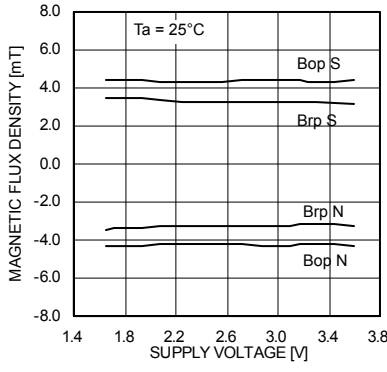

Fig. 13 Bop, Brp– Supply voltage

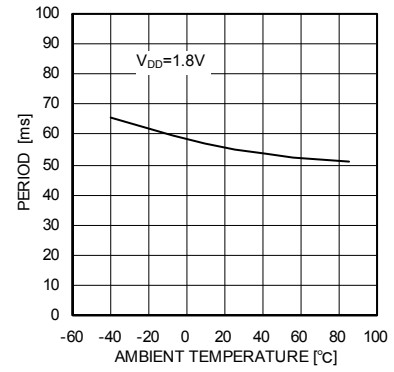

Fig. 14 T_P– Ambient temperature

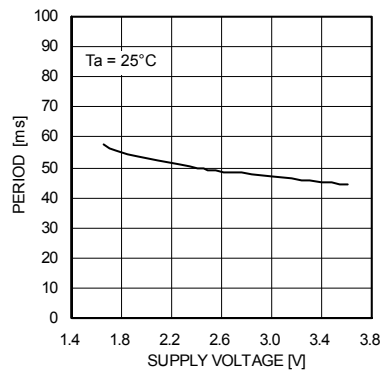

Fig. 15 T_P– Supply voltage

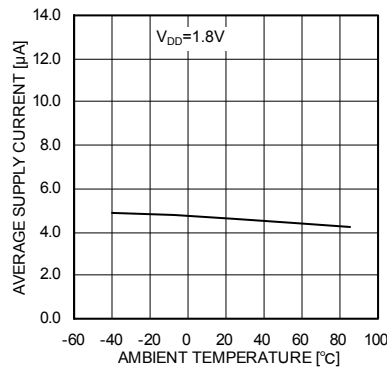

Fig. 16 I_{DD}– Ambient temperature

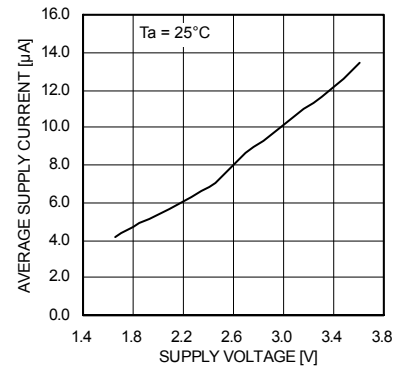

Fig. 17 I_{DD}– Supply voltage

BU52015GUL, BU52011HFV ($V_{DD}=1.65\sim 3.3V$ type)

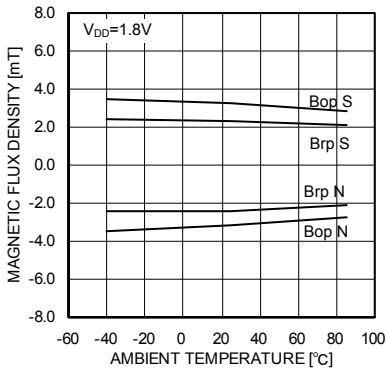

Fig.18 Bop,Brp- Ambient temperature

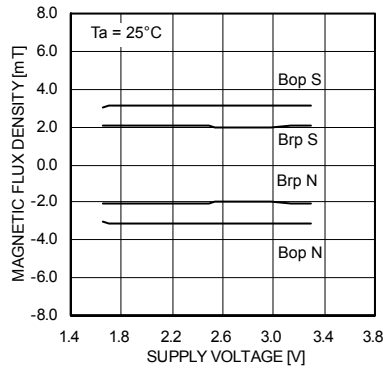

Fig.19 Bop,Brp Supply voltage

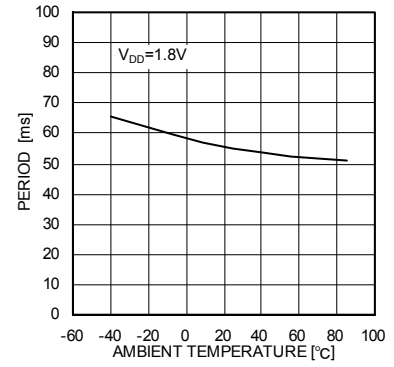

Fig.20 T_P - Ambient temperature

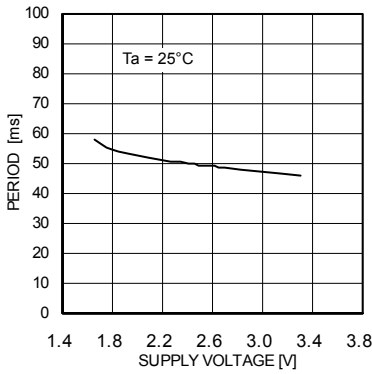

Fig.21 T_P - Supply voltage

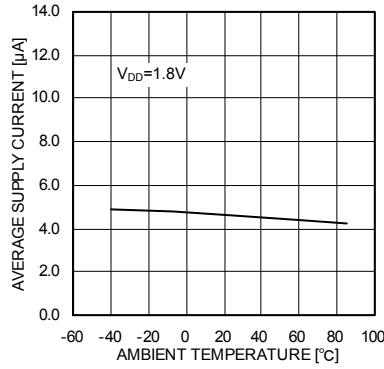

Fig.22 I_{DD} - Ambient temperature

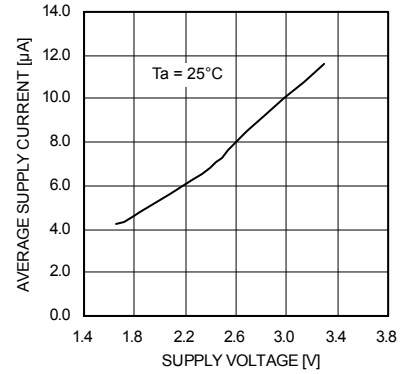

Fig.23 I_{DD} - Supply voltage

BU52001GUL ($V_{DD}=2.4\sim 3.3V$ type)

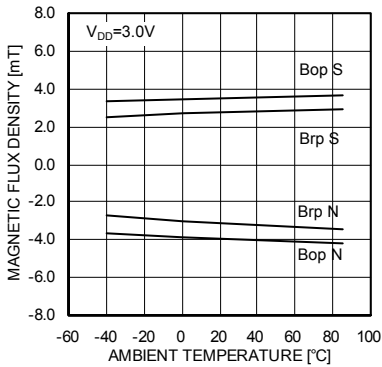

Fig.24 Bop,Brp- Ambient temperature

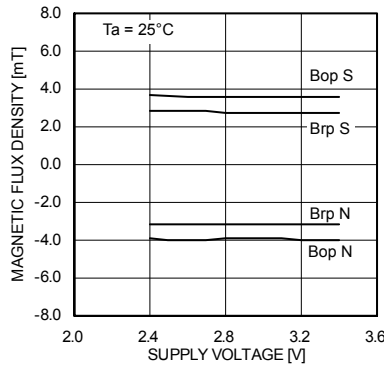

Fig.25 Bop,Brp- Supply voltage

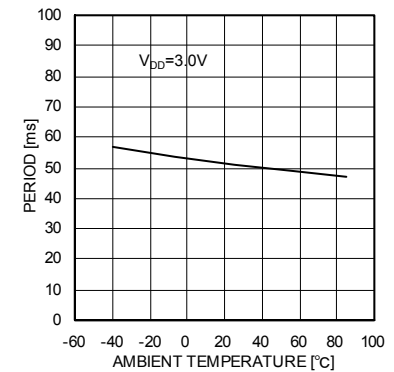

Fig.26 T_P - Ambient temperature

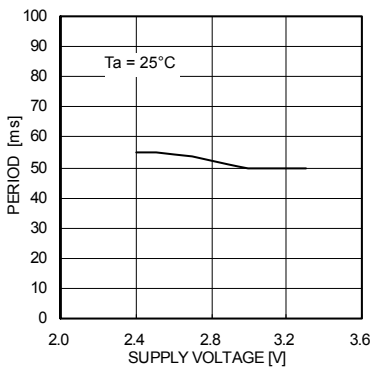

Fig.27 T_P - Supply voltage

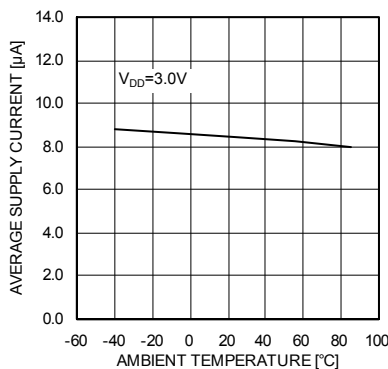

Fig.28 I_{DD} - Ambient temperature

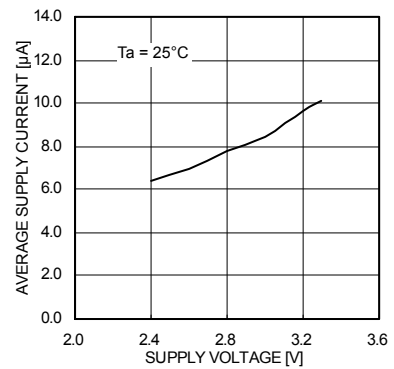

Fig.29 I_{DD} - Supply voltage

BU52061NVX (V_{DD}=1.65~3.6V type)

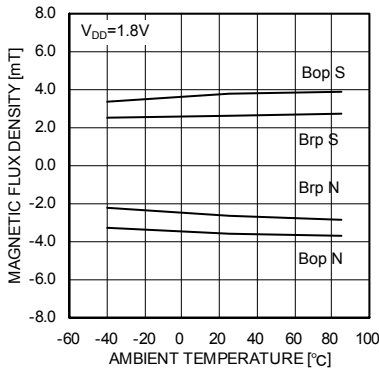

Fig.30 Bop, Brp– Ambient temperature

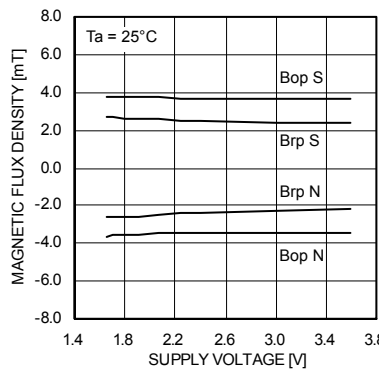

Fig.31 Bop, Brp– Supply voltage

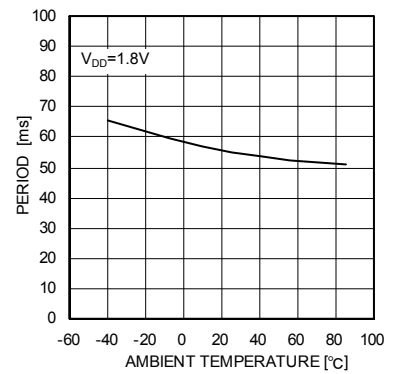

Fig.32 T_P – Ambient temperature

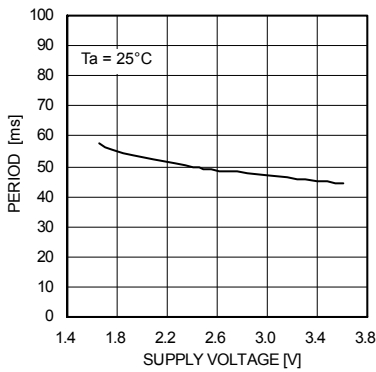

Fig.33 T_P– Supply voltage

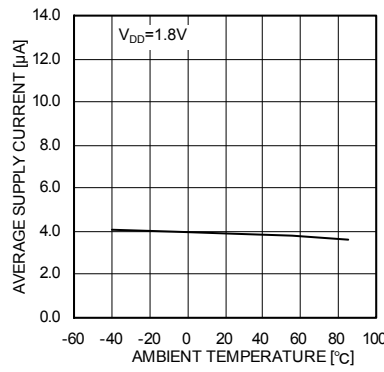

Fig.34 I_{DD}– Ambient temperature

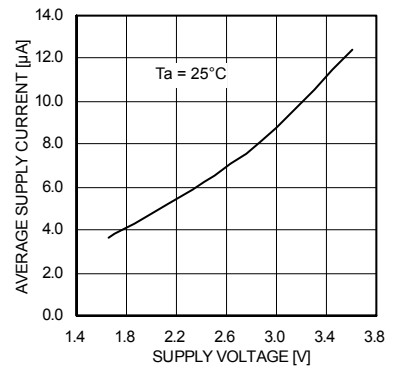

Fig.35 I_{DD} – Supply voltage

BU52053NVX (V_{DD}=1.65~3.6V type)

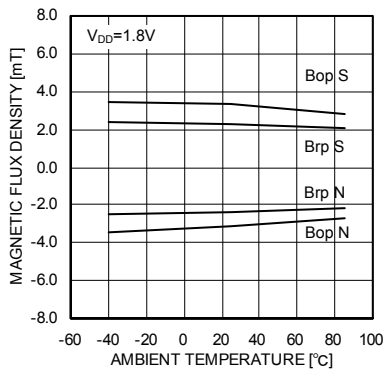

Fig.36 Bop, Brp– Ambient temperature

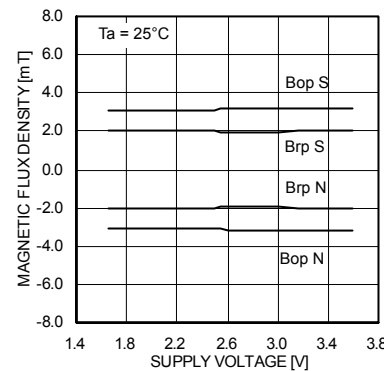

Fig.37 Bop, Brp– Supply voltage

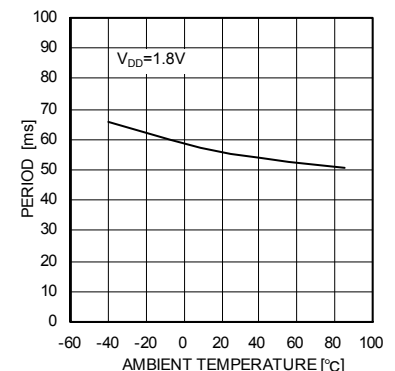

Fig.38 T_P – Ambient temperature

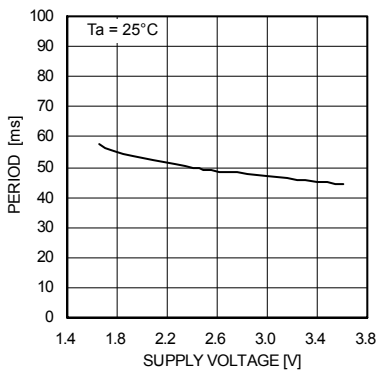

Fig.39 T_P– Supply voltage

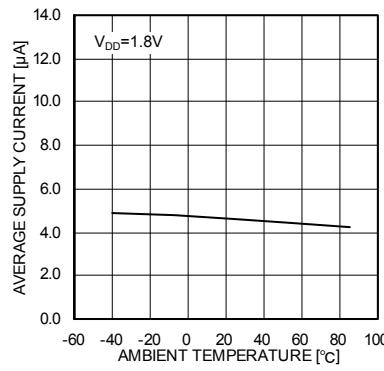

Fig.40 I_{DD}– Ambient temperature

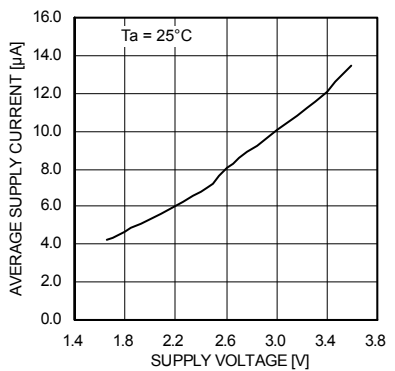

Fig.41 I_{DD} – Supply voltage

BU52056NVX (V_{DD}=1.65~3.6V type)

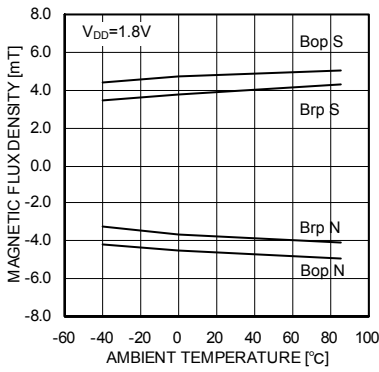

Fig.42 Bop, Brp – Ambient temperature

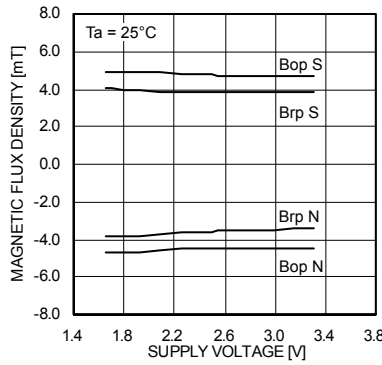

Fig.43 Bop, Brp – Supply voltage

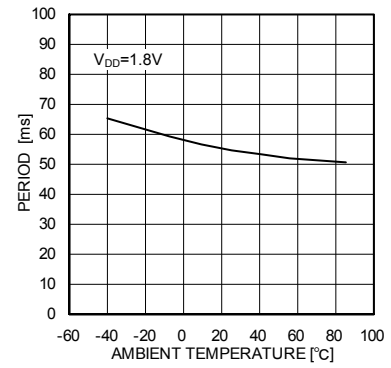

Fig.44 T_P – Ambient temperature

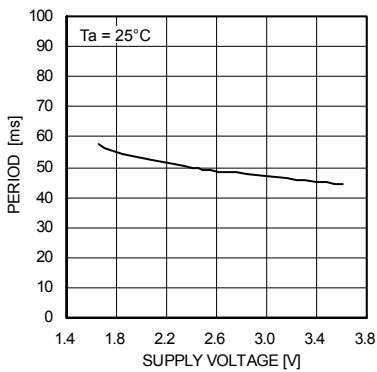

Fig.45 T_P – Supply voltage

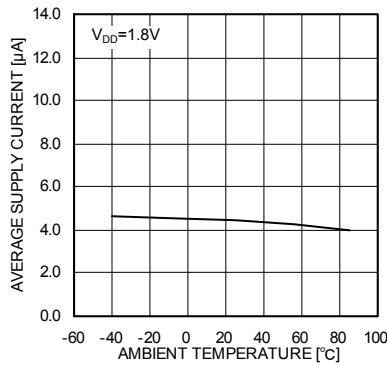

Fig.46 I_{DD} – Ambient temperature

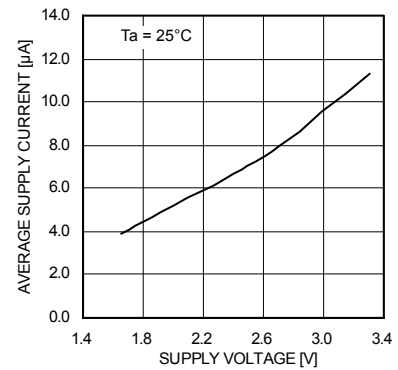

Fig.47 I_{DD} – Supply voltage

BU52021HFV, BU52025G (V_{DD}=2.4~3.6V type)

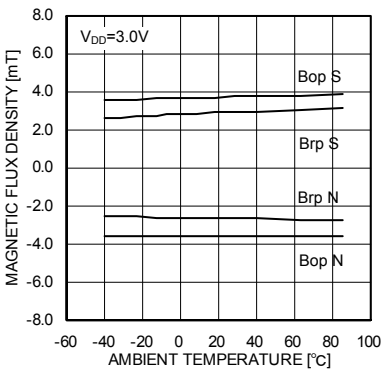

Fig.48 Bop, Brp – Ambient temperature

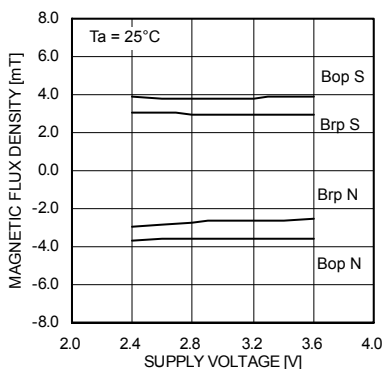

Fig.49 Bop, Brp – Supply voltage

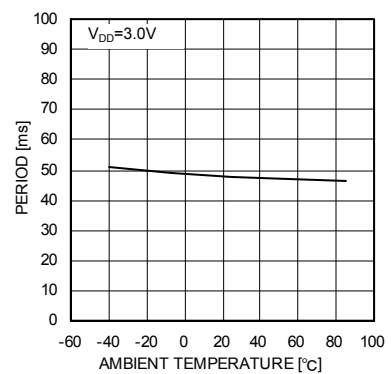

Fig.50 T_P – Ambient temperature

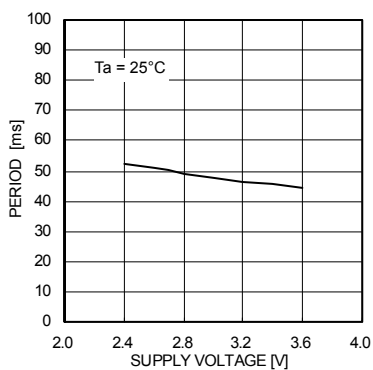

Fig.51 T_P – Supply voltage

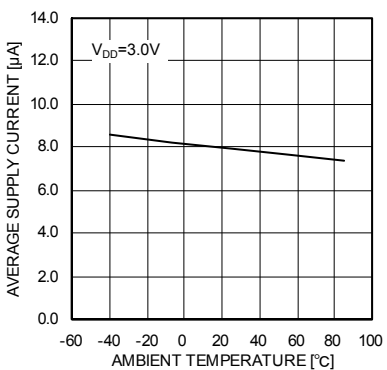

Fig.52 I_{DD} – Ambient temperature

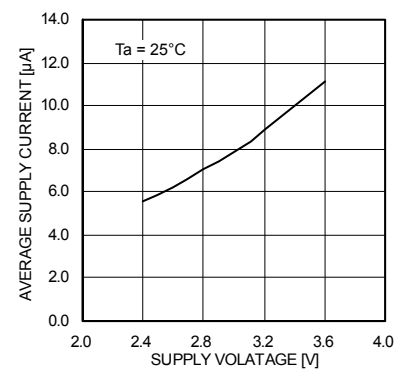

Fig.53 I_{DD} – Supply voltage

BD7411G (V_{DD}=4.5~5.5V type)

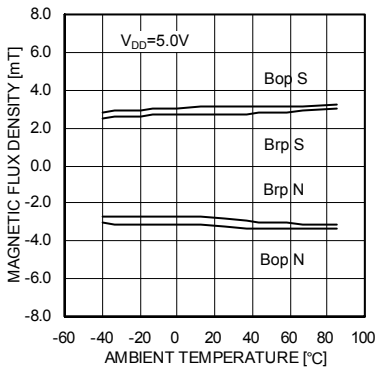

Fig.54 Bop,Brp–Ambient temperature

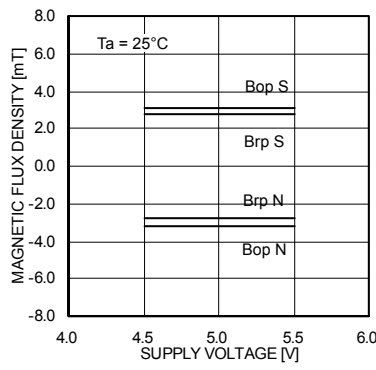

Fig.55 Bop,Brp– Supply voltage

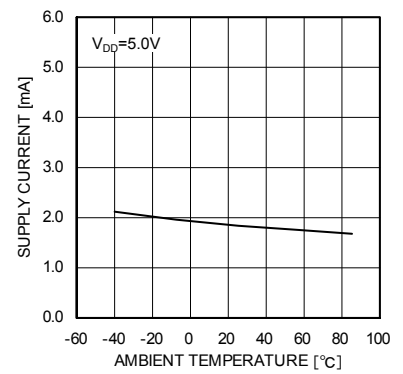

Fig.56 I_{DD} – Ambient temperature

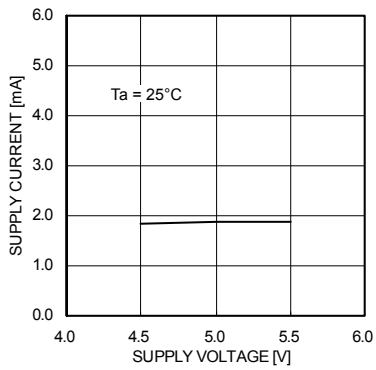
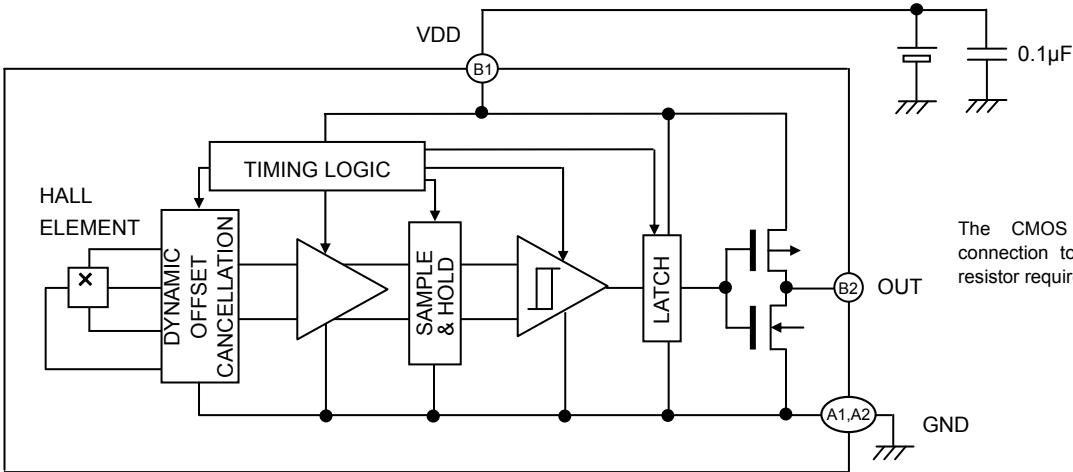

Fig.57 I_{DD} – Supply voltage

● Block Diagram

BU52054GWZ, BU52055GWZ



Adjust the bypass capacitor value as necessary, according to voltage noise conditions, etc.

The CMOS output terminals enable direct connection to the PC, with no external pull-up resistor required.

Fig.58

| PIN No. | PIN NAME | FUNCTION | COMMENT |
|---------|----------|--------------|---------|
| A1 | GND | GROUND | |
| A2 | GND | GROUND | |
| B1 | VDD | POWER SUPPLY | |
| B2 | OUT | OUTPUT | |

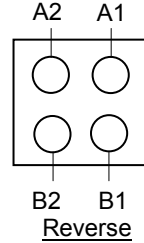
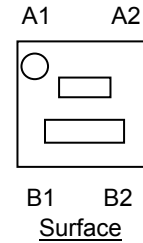

BU52015GUL

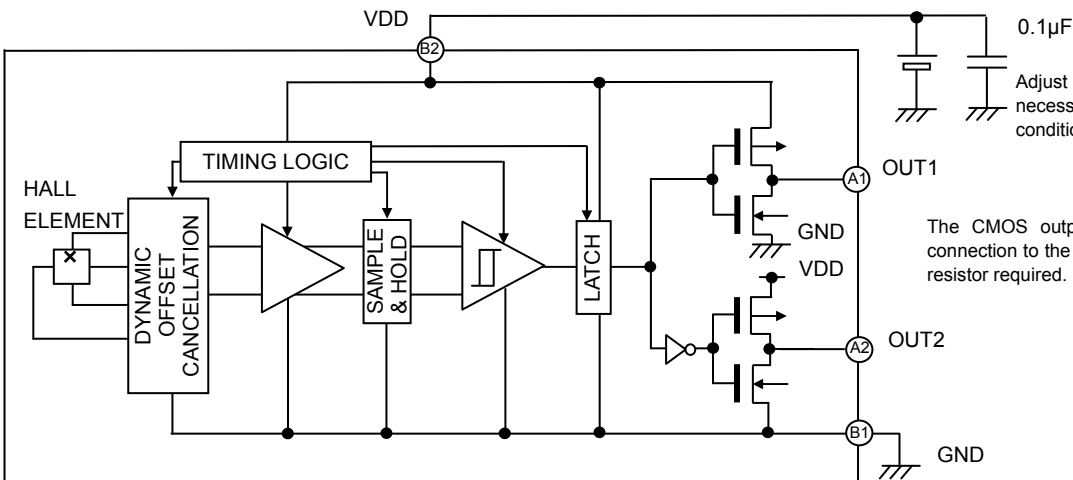

Adjust the bypass capacitor value as necessary, according to voltage noise conditions, etc.

The CMOS output terminals enable direct connection to the PC, with no external pull-up resistor required.

Fig.59

| PIN No. | PIN NAME | FUNCTION | COMMENT |
|---------|----------|--------------------------|---------|
| A1 | OUT1 | Output pin (Active Low) | |
| A2 | OUT2 | Output pin (Active High) | |
| B1 | GND | GROUND | |
| B2 | VDD | Power Supply Voltage | |

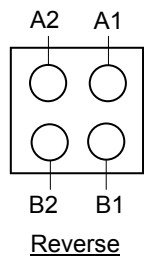
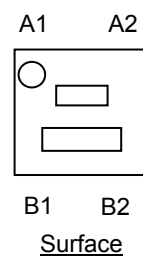

BU52001GUL

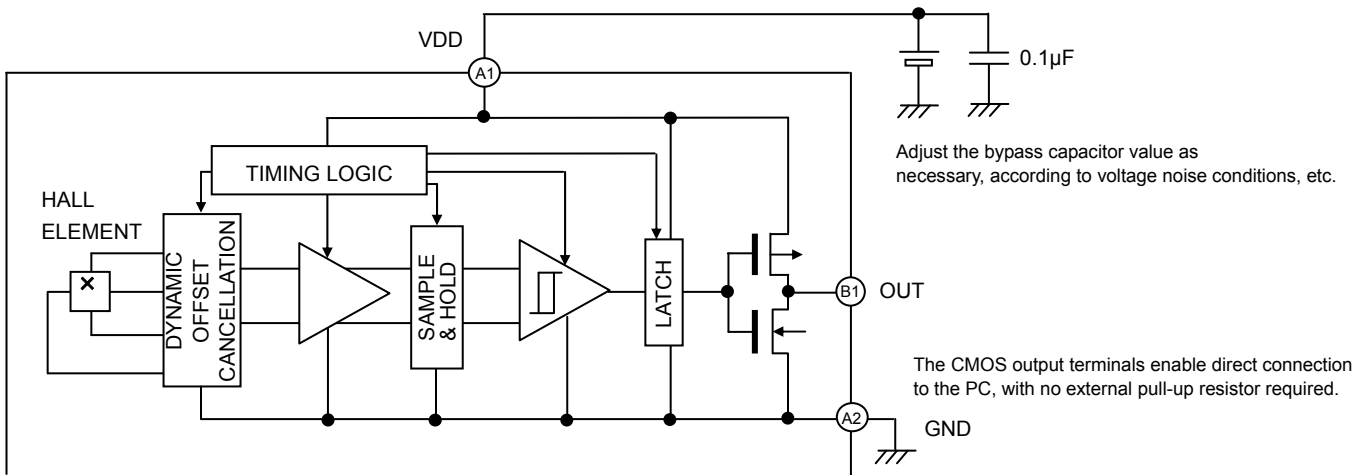
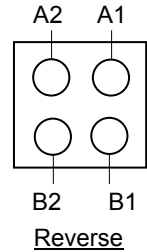
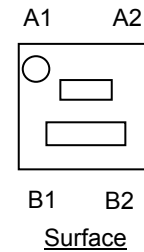

Fig.60

| PIN No. | PIN NAME | FUNCTION | COMMENT |
|---------|----------|--------------|-----------------------|
| A1 | VDD | POWER SUPPLY | |
| A2 | GND | GROUND | |
| B1 | OUT | OUTPUT | |
| B2 | N.C. | | OPEN or Short to GND. |



BU52061NVX, BU52053NVX, BU52056NVX

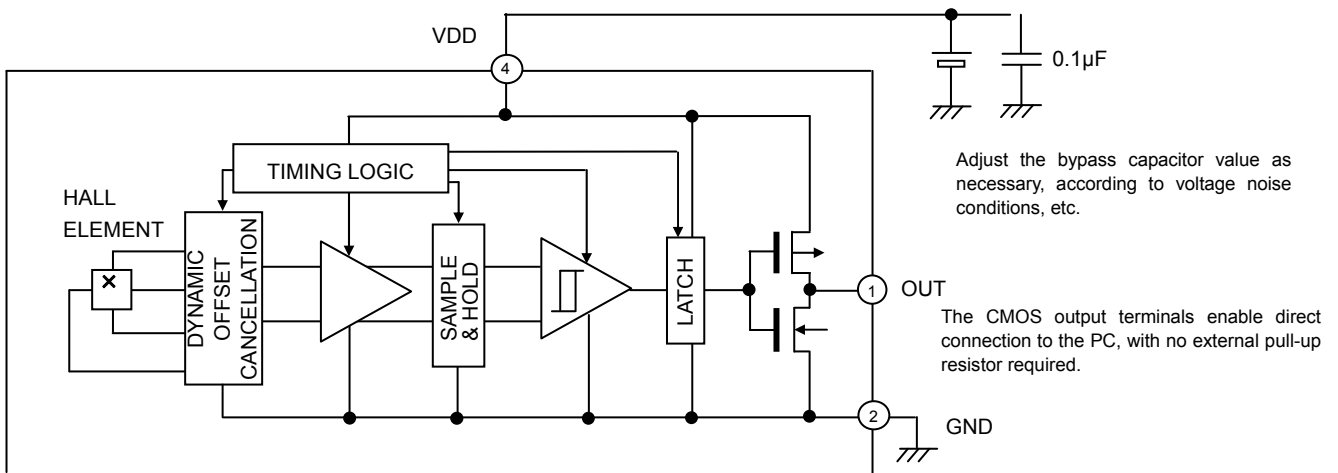
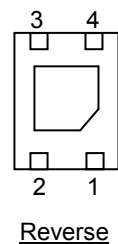
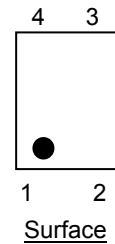

Fig.61

| PIN No. | PIN NAME | FUNCTION | COMMENT |
|---------|----------|--------------|-----------------------|
| 1 | OUT | OUTPUT | |
| 2 | GND | GROUND | |
| 3 | N.C. | | OPEN or Short to GND. |
| 4 | VDD | POWER SUPPLY | |



BU52011HFV, BU52021HFV

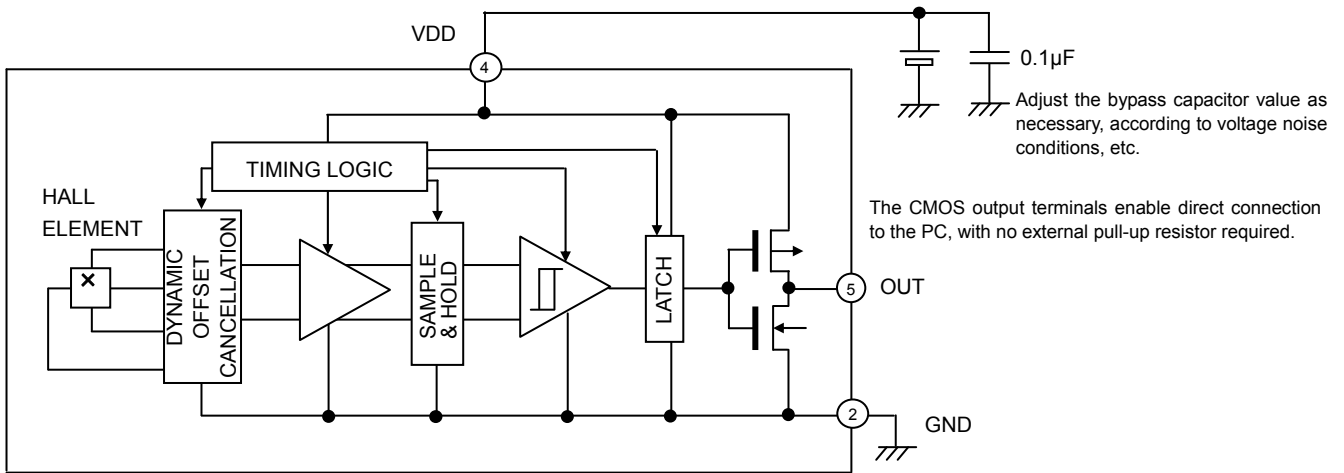
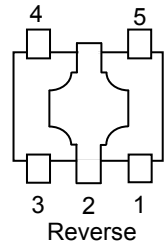
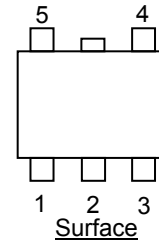

Fig.62

| PIN No. | PIN NAME | FUNCTION | COMMENT |
|---------|----------|--------------|-----------------------|
| 1 | N.C. | | OPEN or Short to GND. |
| 2 | GND | GROUND | |
| 3 | N.C. | | OPEN or Short to GND. |
| 4 | VDD | POWER SUPPLY | |
| 5 | OUT | OUTPUT | |



BU52025G

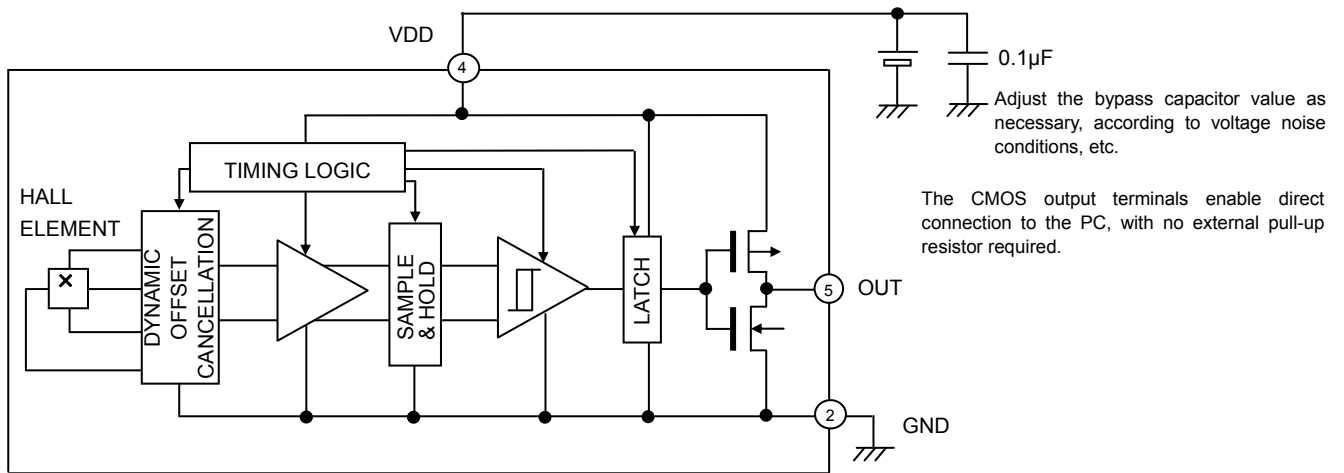
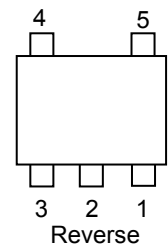
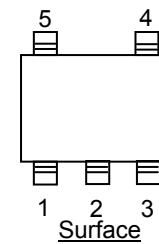

Fig.63

| PIN No. | PIN NAME | FUNCTION | COMMENT |
|---------|----------|--------------|-----------------------|
| 1 | N.C. | | OPEN or Short to GND. |
| 2 | GND | GROUND | |
| 3 | N.C. | | OPEN or Short to GND. |
| 4 | VDD | POWER SUPPLY | |
| 5 | OUT | OUTPUT | |



BD7411G

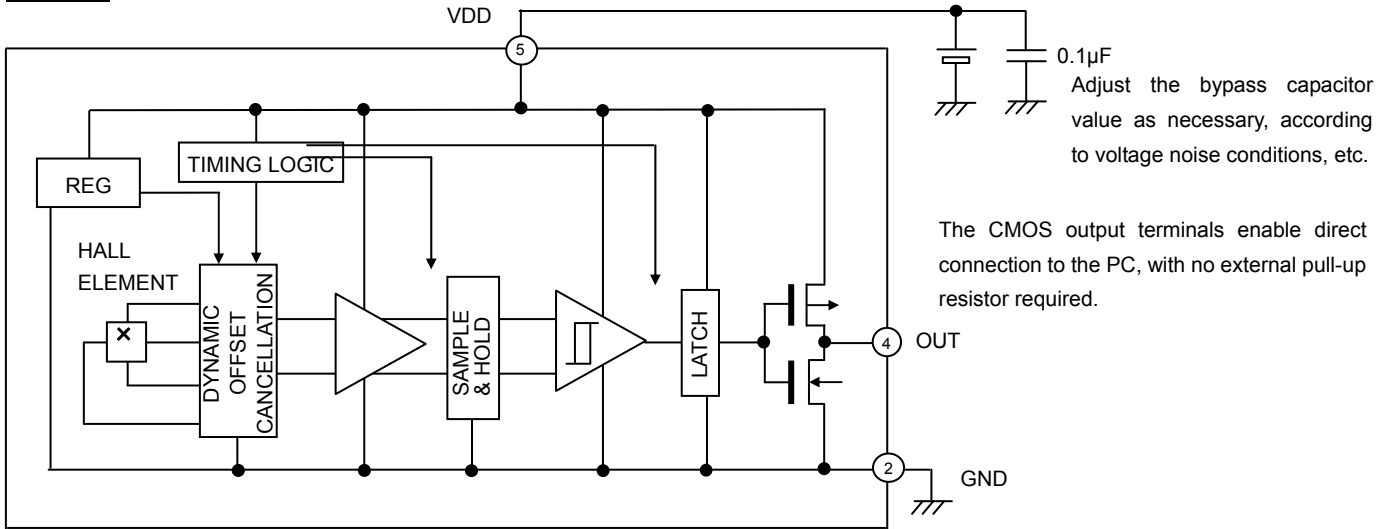
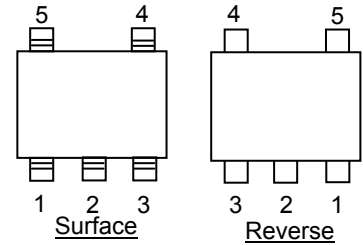

Fig.64

| PIN No. | PIN NAME | FUNCTION | COMMENT |
|---------|----------|--------------|-----------------------|
| 1 | N.C. | | OPEN or Short to GND. |
| 2 | GND | GROUND | |
| 3 | N.C. | | OPEN or Short to GND. |
| 4 | OUT | OUTPUT | |
| 5 | VDD | POWER SUPPLY | |



●Description of Operations

(Micropower Operation)

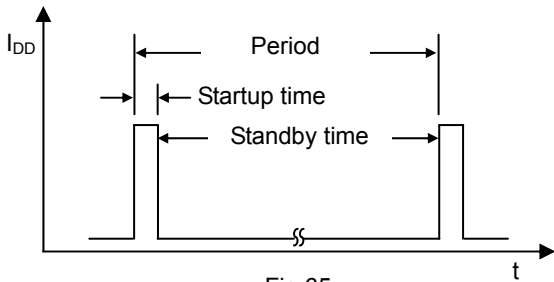

Fig.65

The bipolar detection Hall IC adopts an intermittent operation method to save energy. At startup, the Hall elements, amp, comparator and other detection circuits power ON and magnetic detection begins. During standby, the detection circuits power OFF, thereby reducing current consumption. The detection results are held while standby is active, and then output.

Reference period: 50ms (MAX100ms)
 Reference startup time: 48 μ s

※BD7411G don't adopts an intermittent operation method.

(Offset Cancellation)

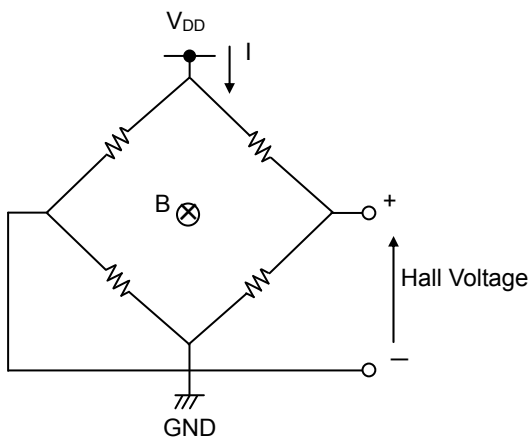

Fig.66

The Hall elements form an equivalent Wheatstone (resistor) bridge circuit. Offset voltage may be generated by a differential in this bridge resistance, or can arise from changes in resistance due to package or bonding stress. A dynamic offset cancellation circuit is employed to cancel this offset voltage.

When Hall elements are connected as shown in Fig. 66 and a magnetic field is applied perpendicular to the Hall elements, voltage is generated at the mid-point terminal of the bridge. This is known as Hall voltage.

Dynamic cancellation switches the wiring (shown in the figure) to redirect the current flow to a 90° angle from its original path, and thereby cancels the Hall voltage.

The magnetic signal (only) is maintained in the sample/hold circuit during the offset cancellation process and then released.

(Magnetic Field Detection Mechanism)

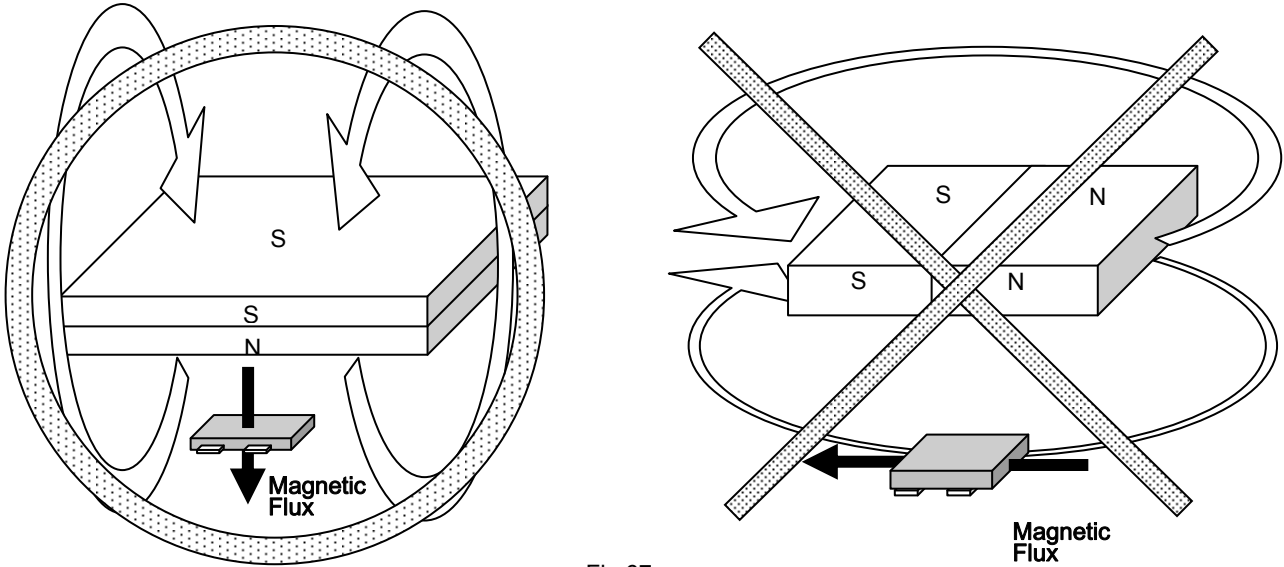

Fig.67

The Hall IC cannot detect magnetic fields that run horizontal to the package top layer. Be certain to configure the Hall IC so that the magnetic field is perpendicular to the top layer.

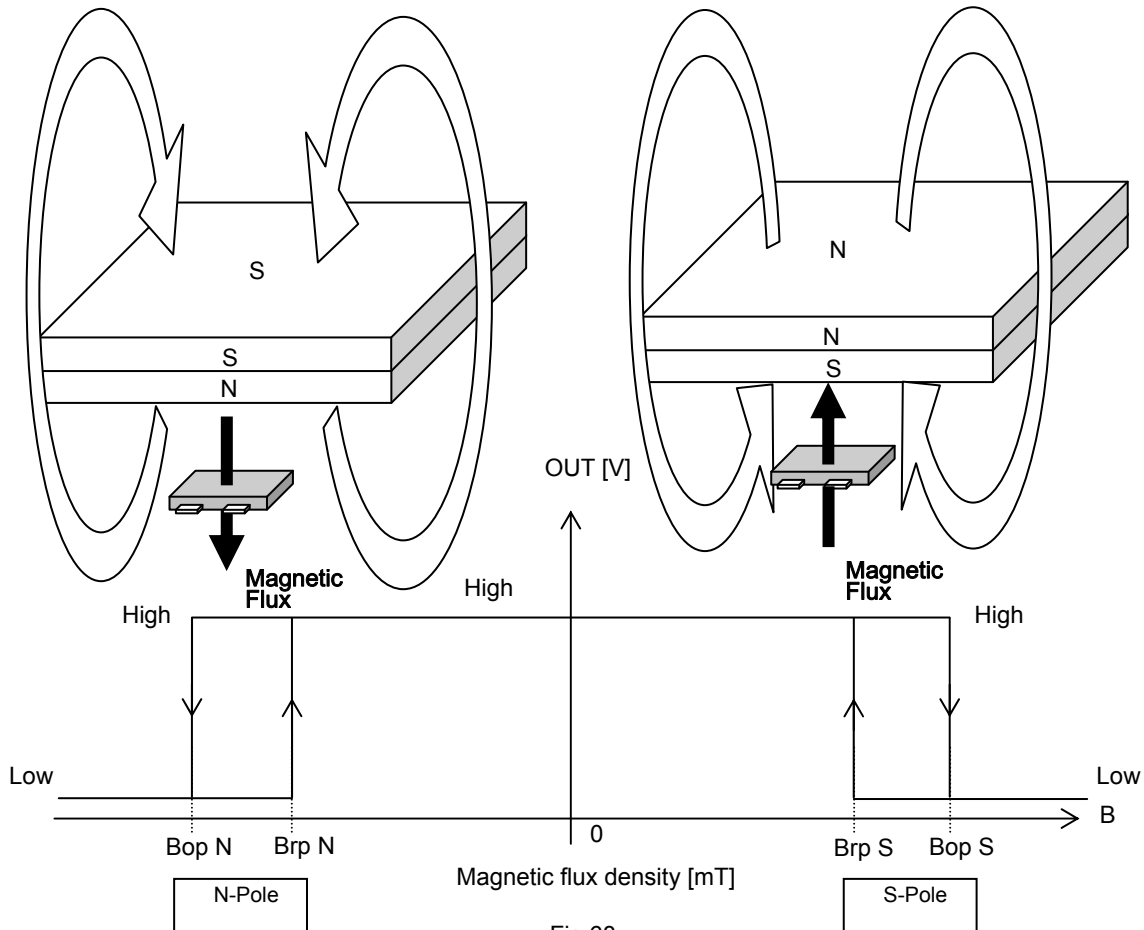

Fig.68

The bipolar detection Hall IC detects magnetic fields running perpendicular to the top surface of the package. There is an inverse relationship between magnetic flux density and the distance separating the magnet and the Hall IC: when distance increases magnetic density falls, to the operate point (Bop), output goes HIGH. When the magnet gets closer to the IC and magnetic density rises, to the operate point, the output switches LOW. In LOW output mode, the distance from the magnet to the IC increases again until the magnetic density falls to a point just below Bop, and output returns HIGH. (This point, where magnetic flux density restores HIGH output, is known as the release point, Brp.) This detection and adjustment mechanism is designed to prevent noise, oscillation and other erratic system operation.

● Intermittent Operation at Power ON
Power ON

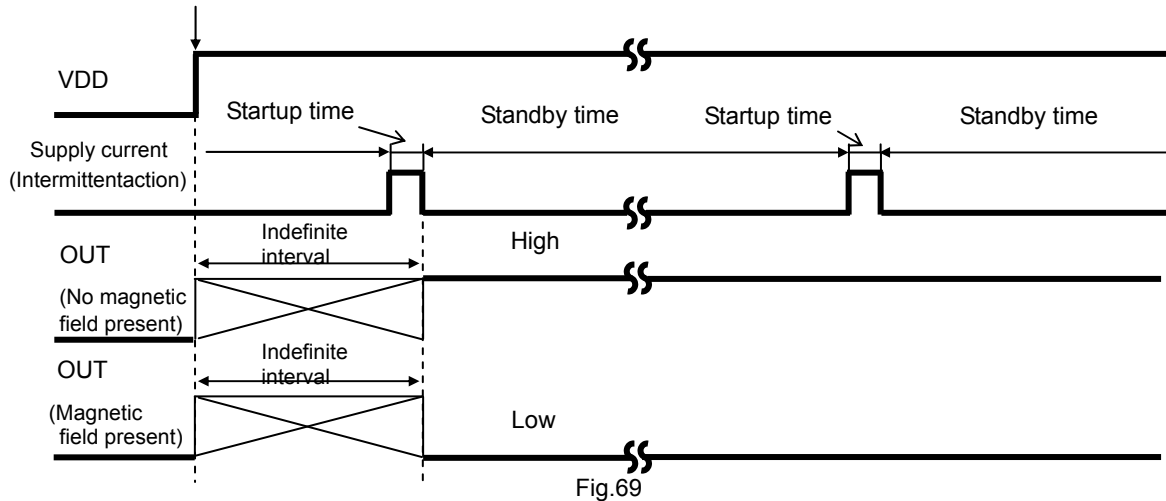

Fig.69

The bipolar detection Hall IC adopts an intermittent operation method in detecting the magnetic field during startup, as shown in Fig. 69. It outputs to the appropriate terminal based on the detection result and maintains the output condition during the standby period. The time from power ON until the end of the initial startup period is an indefinite interval, but it cannot exceed the maximum period, 100ms. To accommodate the system design, the Hall IC output read should be programmed within 100ms of power ON, but after the time allowed for the period ambient temperature and supply voltage. ※BD7411G don't adopts an intermittent operation method.

● Magnet Selection

Of the two representative varieties of permanent magnet, neodymium generally offers greater magnetic power per volume than ferrite, thereby enabling the highest degree of miniaturization. Thus, neodymium is best suited for small equipment applications. Fig. 70 shows the relation between the size (volume) of a neodymium magnet and magnetic flux density. The graph plots the correlation between the distance (L) from three versions of a 4mm X 4mm cross-section neodymium magnet (1mm, 2mm, and 3mm thick) and magnetic flux density. Fig. 71 shows Hall IC detection distance – a good guide for determining the proper size and detection distance of the magnet. Based on the BU52011HFV, BU52015GUL operating point max 5.0 mT, the minimum detection distance for the 1mm, 2mm and 3mm magnets would be 7.6mm, 9.22mm, and 10.4mm, respectively. To increase the magnet's detection distance, either increase its thickness or sectional area.

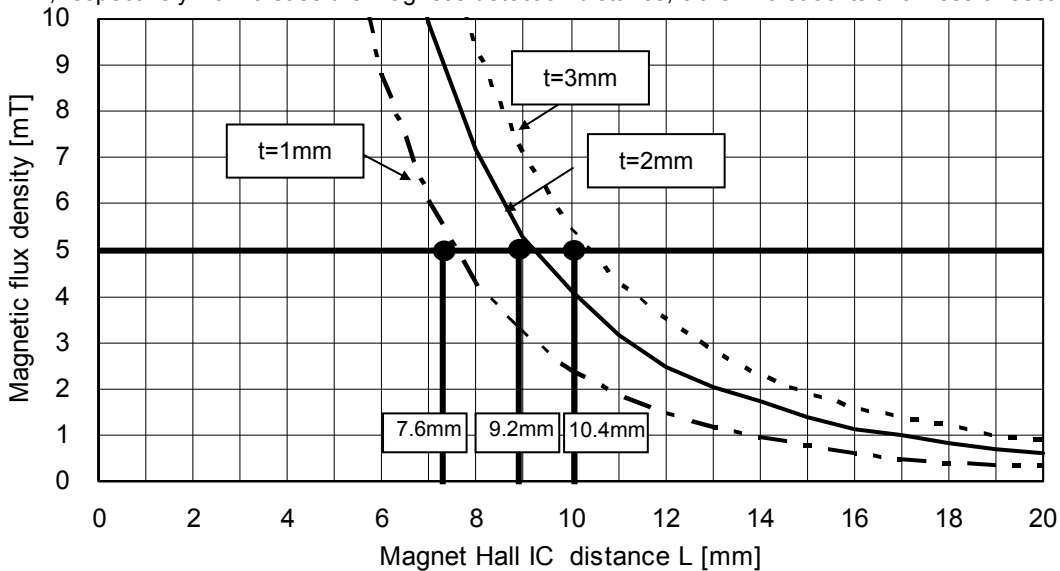
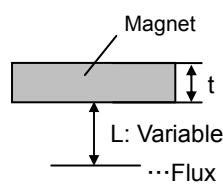
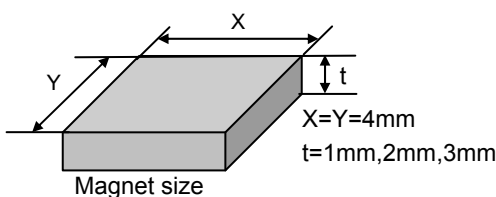

Fig.70



Magnet material: NMX-44CH
Maker: Hitachi Metals.,LTD

... Flux density measuring point

Fig.71 Magnet Dimensions and Flux Density Measuring Point

●Position of the Hall Effect IC(Reference)

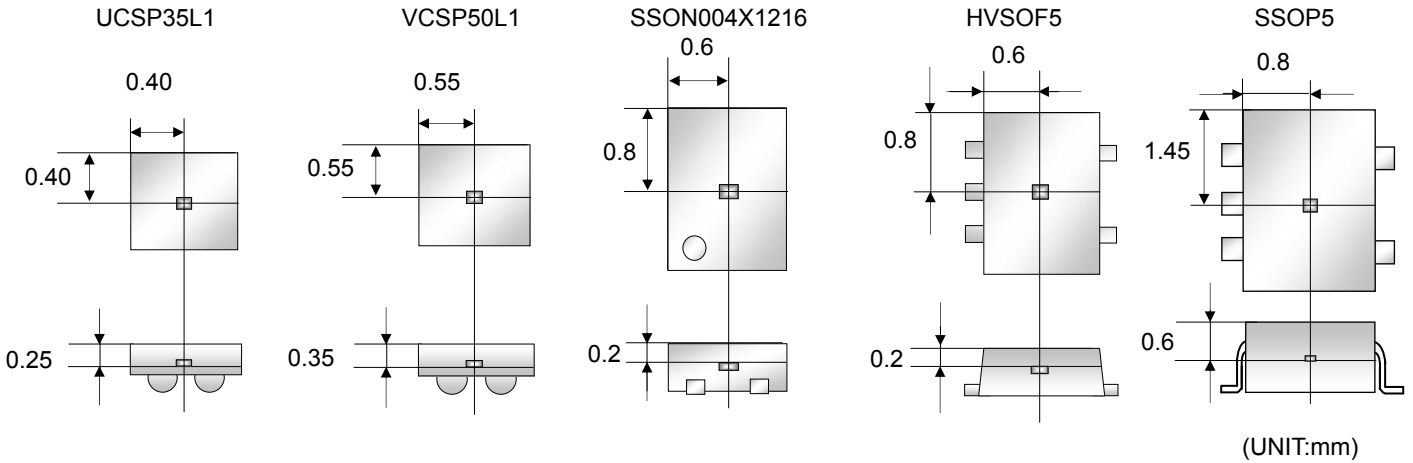

●Footprint dimensions (Optimize footprint dimensions to the board design and soldering condition)

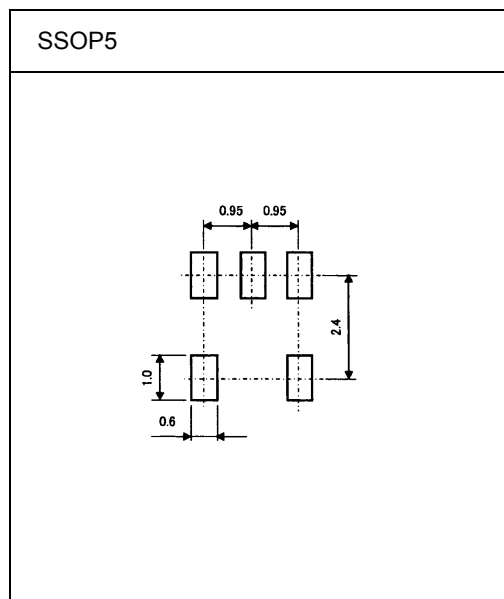
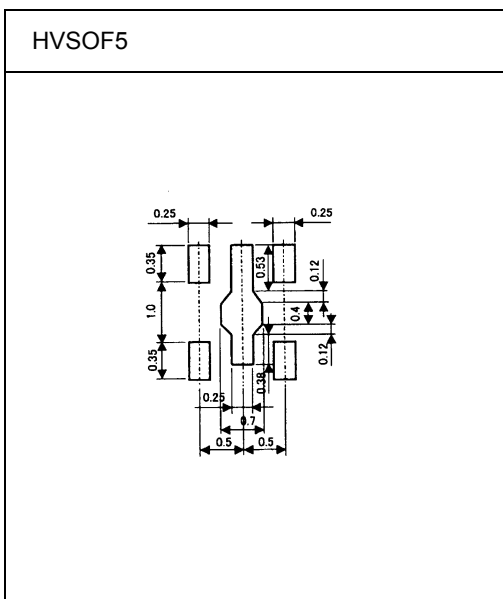
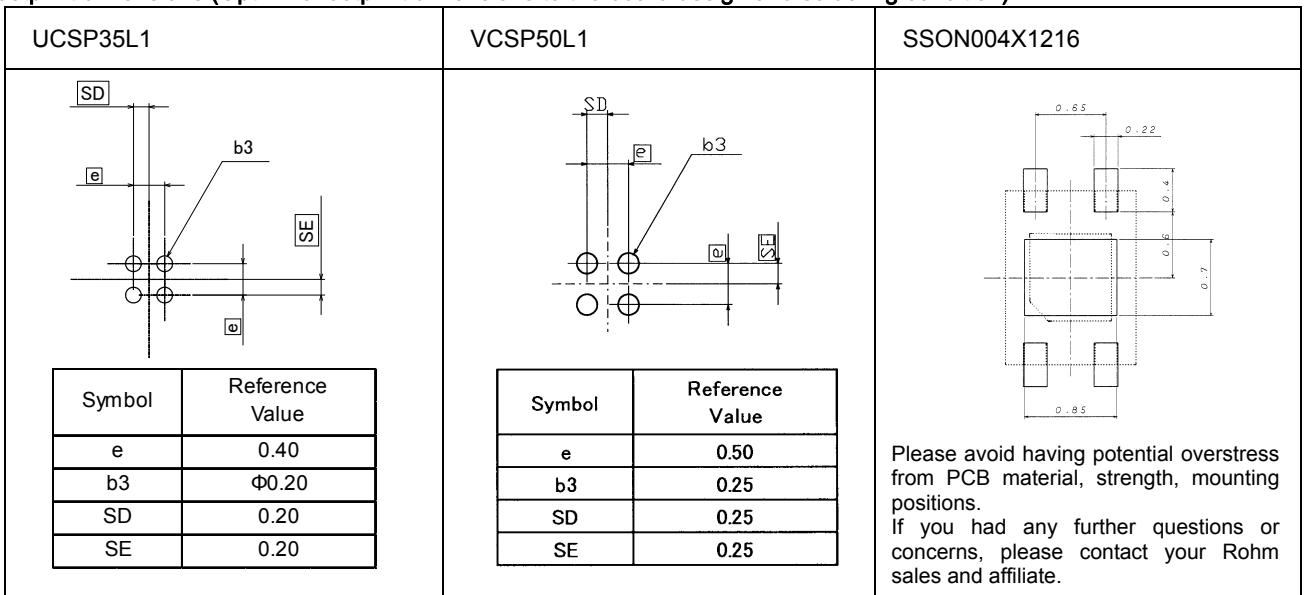

(UNIT:mm)

● Terminal Equivalent Circuit Diagram

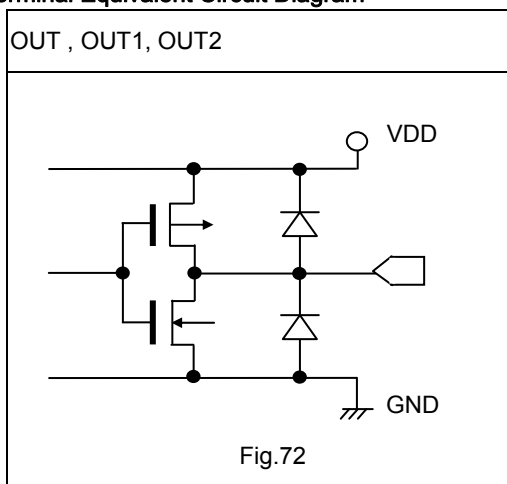

Because they are configured for CMOS (inverter) output, the output pins require no external resistance and allow direct connection to the PC. This, in turn, enables reduction of the current that would otherwise flow to the external resistor during magnetic field detection, and supports overall low current (micropower) operation.

● Notes for use

- 1) Absolute maximum ratings
 Exceeding the absolute maximum ratings for supply voltage, operating conditions, etc. may result in damage to or destruction of the IC. Because the source (short mode or open mode) cannot be identified if the device is damaged in this way, it is important to take physical safety measures such as fusing when implementing any special mode that operates in excess of absolute rating limits.
- 2) GND voltage
 Make sure that the GND terminal potential is maintained at the minimum in any operating state, and is always kept lower than the potential of all other pins.
- 3) Thermal design
 Use a thermal design that allows for sufficient margin in light of the power dissipation (Pd) in actual operating conditions.
- 4) Pin shorts and mounting errors
 Use caution when positioning the IC for mounting on printed circuit boards. Mounting errors, such as improper positioning or orientation, may damage or destroy the device. The IC may also be damaged or destroyed if output pins are shorted together, or if shorts occur between the output pin and supply pin or GND.
- 5) Positioning components in proximity to the Hall IC and magnet
 Positioning magnetic components in close proximity to the Hall IC or magnet may alter the magnetic field, and therefore the magnetic detection operation. Thus, placing magnetic components near the Hall IC and magnet should be avoided in the design if possible. However, where there is no alternative to employing such a design, be sure to thoroughly test and evaluate performance with the magnetic component(s) in place to verify normal operation before implementing the design.
- 6) Slide-by position sensing
 Fig.73 depicts the slide-by configuration employed for position sensing. Note that when the gap (d) between the magnet and the Hall IC is narrowed, the reverse magnetic field generated by the magnet can cause the IC to malfunction. As seen in Fig.74, the magnetic field runs in opposite directions at Point A and Point B. Since the bipolar detection Hall IC can detect the S-pole at Point A and the N-pole at Point B, it can wind up switching output ON as the magnet slides by in the process of position detection. Fig. 75 plots magnetic flux density during the magnet slide-by. Although a reverse magnetic field was generated in the process, the magnetic flux density decreased compared with the center of the magnet. This demonstrates that slightly widening the gap (d) between the magnet and Hall IC reduces the reverse magnetic field and prevents malfunctions.

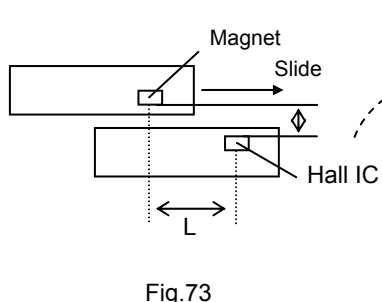

Fig.73

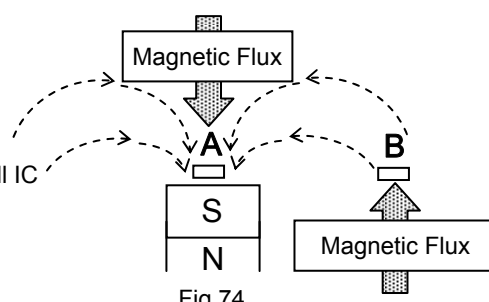

Fig.74

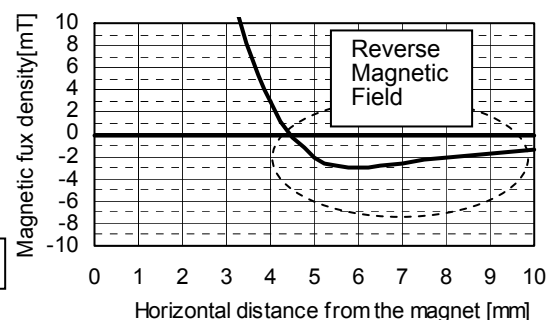

Fig.75

- 7) Operation in strong electromagnetic fields
 Exercise extreme caution about using the device in the presence of a strong electromagnetic field, as such use may cause the IC to malfunction.
- 8) Common impedance
 Make sure that the power supply and GND wiring limits common impedance to the extent possible by, for example, employing short, thick supply and ground lines. Also, take measures to minimize ripple such as using an inductor or capacitor.
- 9) GND wiring pattern
 When both a small-signal GND and high-current GND are provided, single-point grounding at the reference point of the set PCB is recommended, in order to separate the small-signal and high-current patterns, and to ensure that voltage changes due to the wiring resistance and high current do not cause any voltage fluctuation in the small-signal GND. In the same way, care must also be taken to avoid wiring pattern fluctuations in the GND wiring pattern of external components.
- 10) Exposure to strong light
 Exposure to halogen lamps, UV and other strong light sources may cause the IC to malfunction. If the IC is subject to such exposure, provide a shield or take other measures to protect it from the light. In testing, exposure to white LED and fluorescent light sources was shown to have no significant effect on the IC.
- 11) Power source design
 Since the IC performs intermittent operation, it has peak current when it's ON. Please taking that into account and under examine adequate evaluations when designing the power source.

● Ordering part number

| | | | | | | | | | | | | |
|--------------------|---|--|---|---|---|---|---|---|---|---|---|---|
| B | U | 5 | 2 | 0 | 0 | 1 | G | U | L | - | E | 2 |
| Part No. BU, BD | | Part No. 52054, 52055, 52015 52001, 52061, 52053 52056, 52011, 52021 52025, 7411 | | | | | Package GWZ : UCSP35L1 GUL : VSCP50L1 NVX : SSON004X1216 HFV : HVSO5F5 G : SSOP5 | | | Packaging and forming specification E2: Embossed tape and reel (UCSP35L1, VSCP50L1) TR: Embossed tape and reel (SSON004X1216, HVSO5F5, SSOP5) | | |

UCSP35L1(BU52054GWZ)

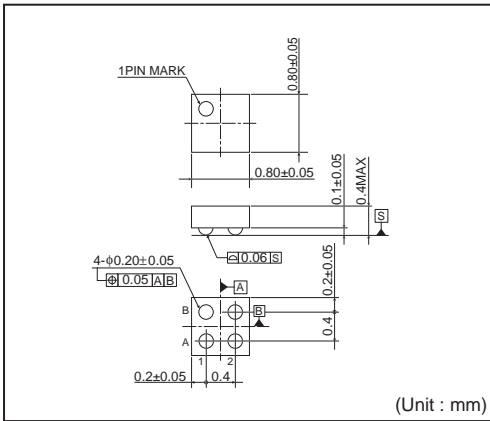

<Tape and Reel information>

| | |
|-------------------|---|
| Tape | Embossed carrier tape |
| Quantity | 3000pcs |
| Direction of feed | E2 (The direction is the 1pin of product is at the upper left when you hold reel on the left hand and you pull out the tape on the right hand) |

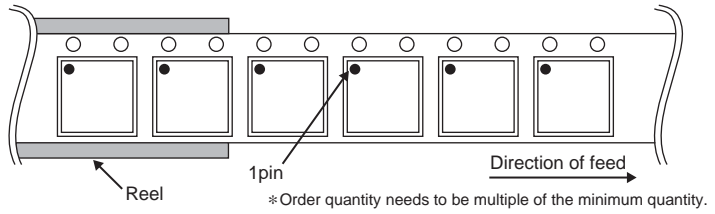

UCSP35L1(BU52055GWZ)

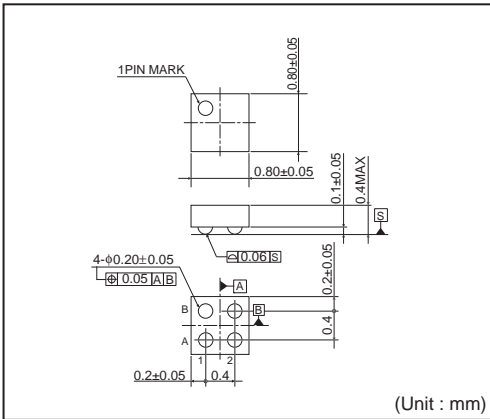

<Tape and Reel information>

| | |
|-------------------|---|
| Tape | Embossed carrier tape |
| Quantity | 3000pcs |
| Direction of feed | E2 (The direction is the 1pin of product is at the upper left when you hold reel on the left hand and you pull out the tape on the right hand) |

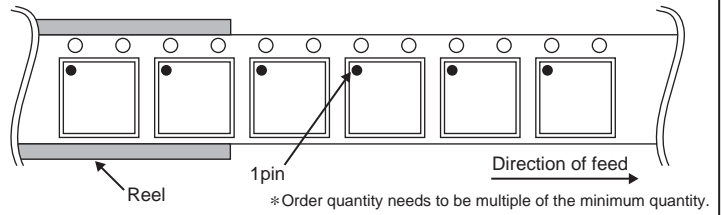

VCSP50L1(BU52015GUL)

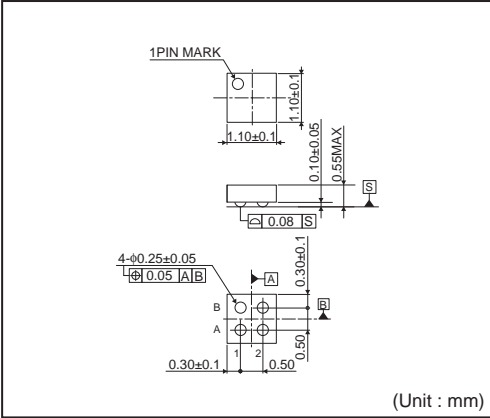

<Tape and Reel information>

| | |
|-------------------|---|
| Tape | Embossed carrier tape |
| Quantity | 3000pcs |
| Direction of feed | E2 (The direction is the 1pin of product is at the upper left when you hold reel on the left hand and you pull out the tape on the right hand) |

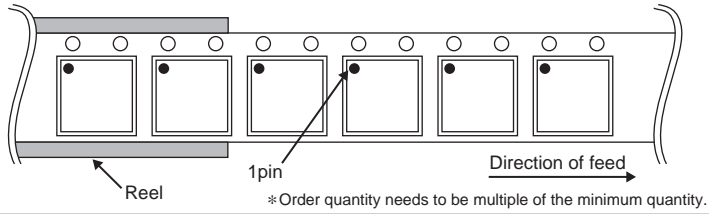

VCSP50L1(BU52001GUL)

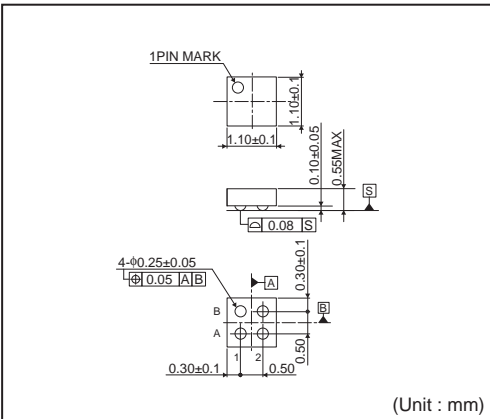

<Tape and Reel information>

| | |
|-------------------|---|
| Tape | Embossed carrier tape |
| Quantity | 3000pcs |
| Direction of feed | E2 (The direction is the 1pin of product is at the upper left when you hold reel on the left hand and you pull out the tape on the right hand) |

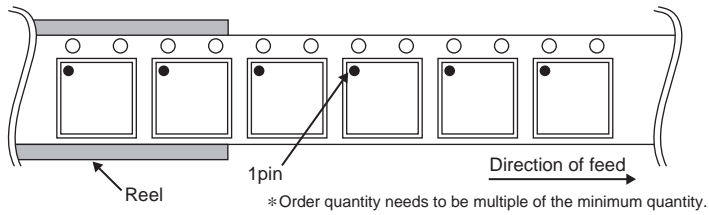

SSON004X1216

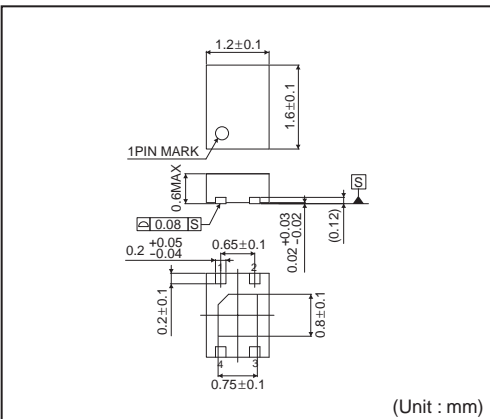

<Tape and Reel information>

| | |
|-------------------|--|
| Tape | Embossed carrier tape |
| Quantity | 5000pcs |
| Direction of feed | TR (The direction is the 1pin of product is at the upper right when you hold reel on the left hand and you pull out the tape on the right hand) |

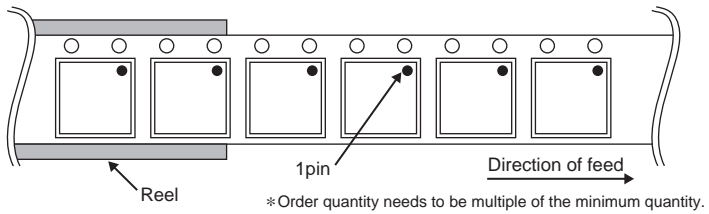

HVSOF5

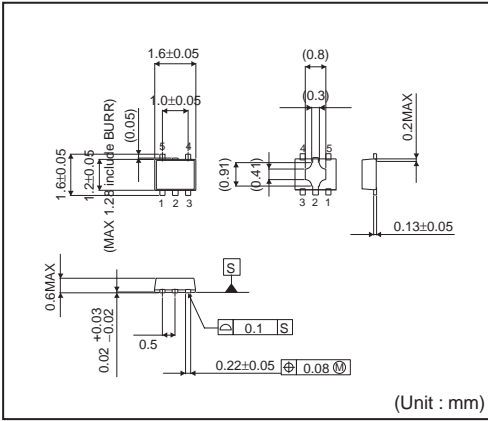

<Tape and Reel information>

| | |
|-------------------|--|
| Tape | Embossed carrier tape |
| Quantity | 3000pcs |
| Direction of feed | TR (The direction is the 1pin of product is at the upper right when you hold reel on the left hand and you pull out the tape on the right hand) |

*Order quantity needs to be multiple of the minimum quantity.

SSOP5

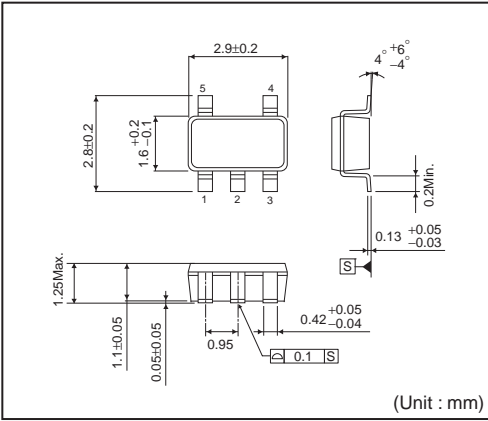

<Tape and Reel information>

| | |
|-------------------|--|
| Tape | Embossed carrier tape |
| Quantity | 3000pcs |
| Direction of feed | TR (The direction is the 1pin of product is at the upper right when you hold reel on the left hand and you pull out the tape on the right hand) |

*Order quantity needs to be multiple of the minimum quantity.

Notice

Precaution on using ROHM Products

- Our Products are designed and manufactured for application in ordinary electronic equipments (such as AV equipment, OA equipment, telecommunication equipment, home electronic appliances, amusement equipment, etc.). If you intend to use our Products in devices requiring extremely high reliability (such as medical equipment ^(Note 1), transport equipment, traffic equipment, aircraft/spacecraft, nuclear power controllers, fuel controllers, car equipment including car accessories, safety devices, etc.) and whose malfunction or failure may cause loss of human life, bodily injury or serious damage to property ("Specific Applications"), please consult with the ROHM sales representative in advance. Unless otherwise agreed in writing by ROHM in advance, ROHM shall not be in any way responsible or liable for any damages, expenses or losses incurred by you or third parties arising from the use of any ROHM's Products for Specific Applications.

(Note1) Medical Equipment Classification of the Specific Applications

| JAPAN | USA | EU | CHINA |
|-----------|-----------|------------|-----------|
| CLASS III | CLASS III | CLASS II b | CLASS III |
| CLASS IV | | CLASS III | |

- ROHM designs and manufactures its Products subject to strict quality control system. However, semiconductor products can fail or malfunction at a certain rate. Please be sure to implement, at your own responsibilities, adequate safety measures including but not limited to fail-safe design against the physical injury, damage to any property, which a failure or malfunction of our Products may cause. The following are examples of safety measures:
 - Installation of protection circuits or other protective devices to improve system safety
 - Installation of redundant circuits to reduce the impact of single or multiple circuit failure
- Our Products are designed and manufactured for use under standard conditions and not under any special or extraordinary environments or conditions, as exemplified below. Accordingly, ROHM shall not be in any way responsible or liable for any damages, expenses or losses arising from the use of any ROHM's Products under any special or extraordinary environments or conditions. If you intend to use our Products under any special or extraordinary environments or conditions (as exemplified below), your independent verification and confirmation of product performance, reliability, etc. prior to use, must be necessary:
 - Use of our Products in any types of liquid, including water, oils, chemicals, and organic solvents
 - Use of our Products outdoors or in places where the Products are exposed to direct sunlight or dust
 - Use of our Products in places where the Products are exposed to sea wind or corrosive gases, including Cl₂, H₂S, NH₃, SO₂, and NO₂
 - Use of our Products in places where the Products are exposed to static electricity or electromagnetic waves
 - Use of our Products in proximity to heat-producing components, plastic cords, or other flammable items
 - Sealing or coating our Products with resin or other coating materials
 - Use of our Products without cleaning residue of flux (even if you use no-clean type fluxes, cleaning residue of flux is recommended); or Washing our Products by using water or water-soluble cleaning agents for cleaning residue after soldering
 - Use of the Products in places subject to dew condensation
- The Products are not subject to radiation-proof design.
- Please verify and confirm characteristics of the final or mounted products in using the Products.
- In particular, if a transient load (a large amount of load applied in a short period of time, such as pulse. is applied, confirmation of performance characteristics after on-board mounting is strongly recommended. Avoid applying power exceeding normal rated power; exceeding the power rating under steady-state loading condition may negatively affect product performance and reliability.
- De-rate Power Dissipation (Pd) depending on Ambient temperature (Ta). When used in sealed area, confirm the actual ambient temperature.
- Confirm that operation temperature is within the specified range described in the product specification.
- ROHM shall not be in any way responsible or liable for failure induced under deviant condition from what is defined in this document.

Precaution for Mounting / Circuit board design

- When a highly active halogenous (chlorine, bromine, etc.) flux is used, the residue of flux may negatively affect product performance and reliability.
- In principle, the reflow soldering method must be used; if flow soldering method is preferred, please consult with the ROHM representative in advance.

For details, please refer to ROHM Mounting specification

Precautions Regarding Application Examples and External Circuits

1. If change is made to the constant of an external circuit, please allow a sufficient margin considering variations of the characteristics of the Products and external components, including transient characteristics, as well as static characteristics.
2. You agree that application notes, reference designs, and associated data and information contained in this document are presented only as guidance for Products use. Therefore, in case you use such information, you are solely responsible for it and you must exercise your own independent verification and judgment in the use of such information contained in this document. ROHM shall not be in any way responsible or liable for any damages, expenses or losses incurred by you or third parties arising from the use of such information.

Precaution for Electrostatic

This Product is electrostatic sensitive product, which may be damaged due to electrostatic discharge. Please take proper caution in your manufacturing process and storage so that voltage exceeding the Products maximum rating will not be applied to Products. Please take special care under dry condition (e.g. Grounding of human body / equipment / solder iron, isolation from charged objects, setting of ionizer, friction prevention and temperature / humidity control).

Precaution for Storage / Transportation

1. Product performance and soldered connections may deteriorate if the Products are stored in the places where:
 - [a] the Products are exposed to sea winds or corrosive gases, including Cl₂, H₂S, NH₃, SO₂, and NO₂
 - [b] the temperature or humidity exceeds those recommended by ROHM
 - [c] the Products are exposed to direct sunshine or condensation
 - [d] the Products are exposed to high Electrostatic
2. Even under ROHM recommended storage condition, solderability of products out of recommended storage time period may be degraded. It is strongly recommended to confirm solderability before using Products of which storage time is exceeding the recommended storage time period.
3. Store / transport cartons in the correct direction, which is indicated on a carton with a symbol. Otherwise bent leads may occur due to excessive stress applied when dropping of a carton.
4. Use Products within the specified time after opening a humidity barrier bag. Baking is required before using Products of which storage time is exceeding the recommended storage time period.

Precaution for Product Label

QR code printed on ROHM Products label is for ROHM's internal use only.

Precaution for Disposition

When disposing Products please dispose them properly using an authorized industry waste company.

Precaution for Foreign Exchange and Foreign Trade act

Since our Products might fall under controlled goods prescribed by the applicable foreign exchange and foreign trade act, please consult with ROHM representative in case of export.

Precaution Regarding Intellectual Property Rights

1. All information and data including but not limited to application example contained in this document is for reference only. ROHM does not warrant that foregoing information or data will not infringe any intellectual property rights or any other rights of any third party regarding such information or data. ROHM shall not be in any way responsible or liable for infringement of any intellectual property rights or other damages arising from use of such information or data.:
2. No license, expressly or implied, is granted hereby under any intellectual property rights or other rights of ROHM or any third parties with respect to the information contained in this document.

Other Precaution

1. This document may not be reprinted or reproduced, in whole or in part, without prior written consent of ROHM.
2. The Products may not be disassembled, converted, modified, reproduced or otherwise changed without prior written consent of ROHM.
3. In no event shall you use in any way whatsoever the Products and the related technical information contained in the Products or this document for any military purposes, including but not limited to, the development of mass-destruction weapons.
4. The proper names of companies or products described in this document are trademarks or registered trademarks of ROHM, its affiliated companies or third parties.

General Precaution

1. Before you use our Products, you are requested to carefully read this document and fully understand its contents. ROHM shall not be in any way responsible or liable for failure, malfunction or accident arising from the use of any ROHM's Products against warning, caution or note contained in this document.
2. All information contained in this document is current as of the issuing date and subject to change without any prior notice. Before purchasing or using ROHM's Products, please confirm the latest information with a ROHM sales representative.
3. The information contained in this document is provided on an "as is" basis and ROHM does not warrant that all information contained in this document is accurate and/or error-free. ROHM shall not be in any way responsible or liable for any damages, expenses or losses incurred by you or third parties resulting from inaccuracy or errors of or concerning such information.