

# APPROVAL SHEET



**WTCF2012 Series**  
**COMMON MODE CHOKE**

\*Contents in this sheet are subject to change without prior notice.

## Features

1. Wire wound type common mode choke.
2. Excellent solderability.

## Applications

1. USB line for personal computers and peripheral.
2. USB 2.0、IEEE1394、LVDS.

## Shape and Dimension

Unit: mm

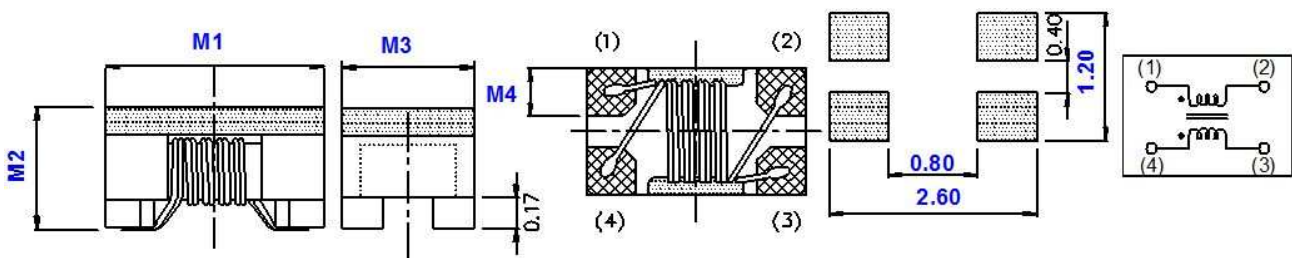

SERIES	M1	M2	M3	M4
WTCF2012	2.0±0.2	1.20±0.2	1.20±0.2	0.40(TYP.)

## Ordering Information

WT	CF	2012	Z0	M	670	P	B
<b>Product Code</b>	<b>Series</b>	<b>Dimensions</b>	<b>Series extension</b>	<b>Tolerance</b>	<b>Value</b>	<b>Packing Code</b>	
WT: Transformer /Balun /Common Mode Choke	COMMON MODE CHOKE	2.0 * 1.2 mm	Z0:STD	M: ± 20%	670 = 67OHM 101 = 100OHM	P=7" Reeled (Embossed tape)	B:STD

## Electrical Characteristics

WTCF2012 Series	Z (OHM) @100MHz ±20%	DCR MAX. (Ω)	RATE CURRENT (mA)	Cut-off Frequency (GHz) TYP.	Rated Voltage (Vdc)	Withstand Voltage (Vdc)	Insulation Resistance @125VDC (MOHM) MIN.
WTCF2012Z0M670PB	67	0.25	400	1.0	50	125	10
WTCF2012Z0M750PB	75	0.30	400				
WTCF2012Z0M900PB	90	0.35	330				
WTCF2012Z0M101PB	100	0.35	330				
WTCF2012Z0M121PB	120	0.30	370				
WTCF2012Z0M161PB	160	0.35	350				
WTCF2012Z0M181PB	180	0.35	330				
WTCF2012Z0M201PB	200	0.40	300				
WTCF2012Z0M221PB	220	0.40	300				
WTCF2012Z0M261PB	260	0.40	300				
WTCF2012Z0M361PB	360	0.50	300				
WTCF2012Z0M371PB	370	0.45	280				
WTCF2012Z0M431PB	430	0.55	280				
WTCF2012Z0M601PB	600	0.60	240				
WTCF2012Z0M751PB	750	0.90	220				

### TEST INSTRUMENT

Z Test by Agilent4291B+16197A

DCR Test by Zentech502BC

Insulation Resistance Test by Agilent 4338B

OPERATING TEMPERATURE RANGE: -40°C ~ +125°C

## TYPICAL RoHS REFLOW PROFILE

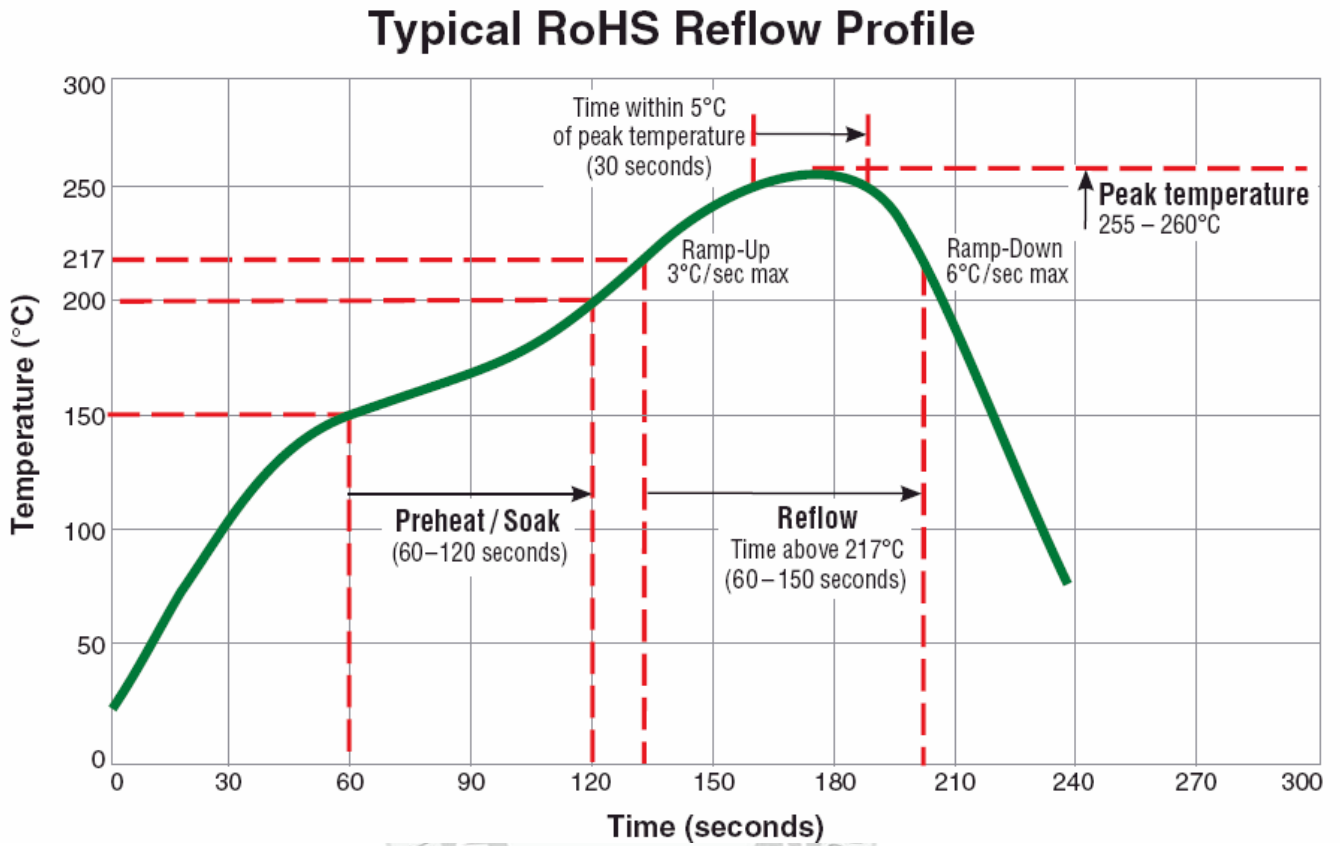

## RELIABILITY PERFORMANCE

### Reliability Experiment For Electrical

Test Item	Test Condition	Standard Source
Humidity Test	+40°C ± 2°C, humidity of 90% ± 5% (total 96 hours).	MIL-STD-202G Method 103B Test Condition B
High Temperature Test	1.Temperature: +125°C ± 2°C 2.Test time: 48 ± 2hrs	IEC 68-2 Test Condition B
Low Temperature Test	1.Temperature: -40°C ± 2°C 2.Test time: 48 ± 2hrs	IEC 68-2 Test Condition A
Thermal Shock	+125°C ± 5°C (30 minutes) ~ -40 ± 5°C (30 minutes), temperature switch time: 5 minutes (total 50 cycles).	MIL-STD-202G Method 107G Test Condition B-2
Life Test	+70°C ± 5°C (250Hours)	MIL-STD-202G Method 108A Test Condition B

### Reliability Experiment For Physical

Test Item	Test Condition	Standard Source
Vibration Test	10-55-10HZ, amplitude: 1.5mm, direction: X, Y, Z axes, each axis 2 hours (total 6 hours).	MIL-STD-202G Method 201A
Solder Heat Resistance Test	IR/convection reflow: Peak Temp 250 ± 5°C for 5Sec in air, Through 2 Cycle. Temperature Ramp: +1~4°C/sec; Above 183°C, must keep 90 s - 120 s	MIL-STD-202G Method 210F Test Condition (Reflow)
Solder Ability Test	Soak in 245 °C solder pot of 3Sec, PAD must have 95% above coverage.	J-STD-003B

### Tape & Reel Packaging Dimensions:

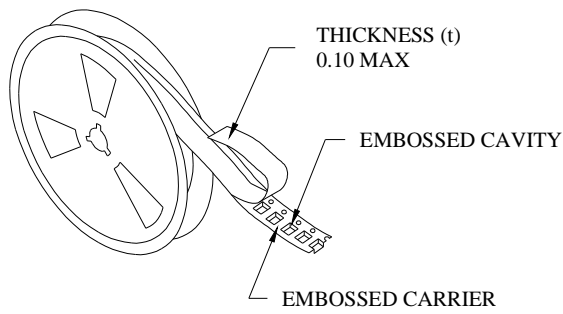

- THE FORCE FOR TEARING OFF COVER TAPE IS 10 TO 100 GRAMS IN THE ARROW DIRECTION.

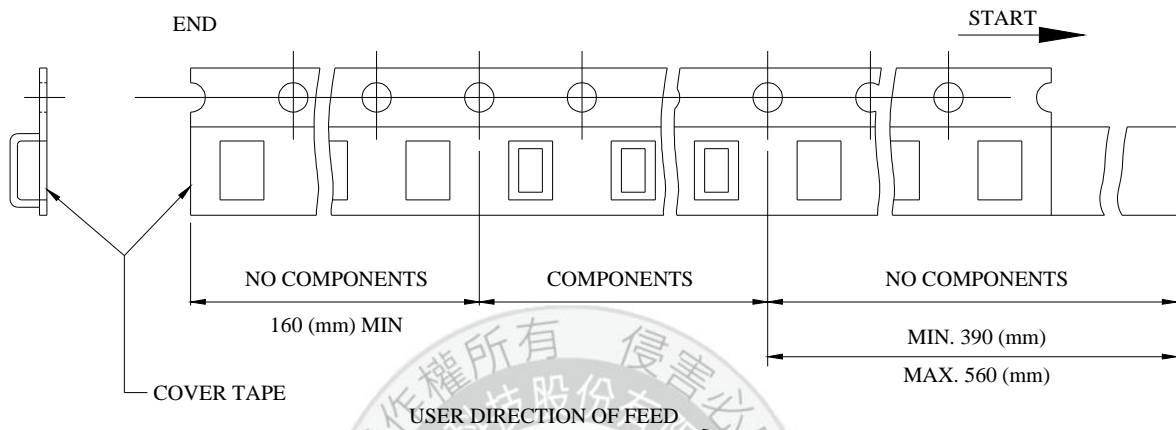
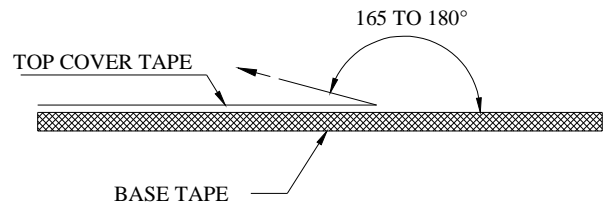

### ■ CARRIER TAPE REELS (mm)

MATERIAL: PLASTIC

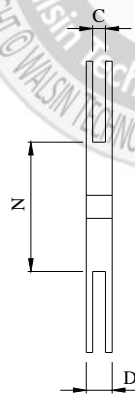
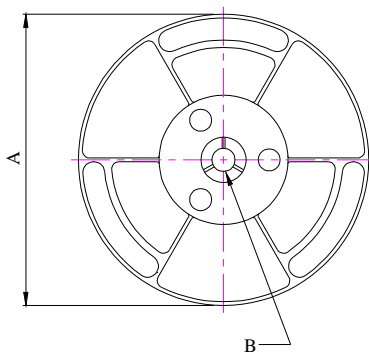

### ■ DIMENSIONS OF CARRIER TAPE (mm)

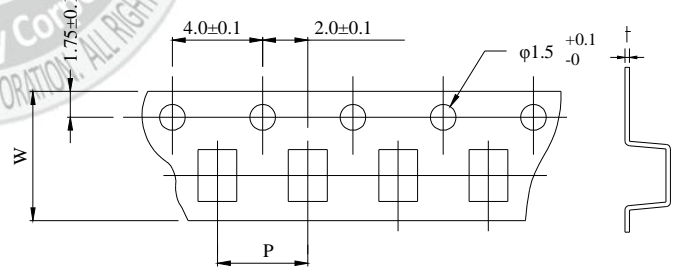

UNIT : mm

	A	B	C	D	N	P	W	t
DIM.	178	13.0	8.4	12.5	75	4.0	8.00	0.24
TOL.	±2.0	±0.8	+1.0-0	MAX	±1.5	±0.10	±0.20	±0.01

Quantity per reel : 2K pcs