

High voltage ultrafast diode

Datasheet - production data

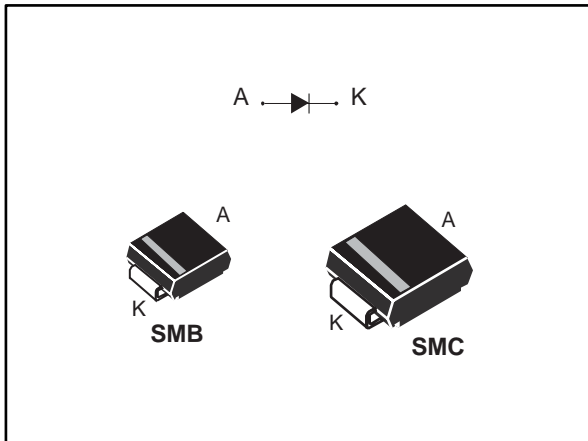

Description

This device is an ultrafast diode based on a high voltage planar technology, it is perfectly suited for freewheeling, clamping, snubbing, demagnetization in power supplies and other power switching applications.

Housed in SMB and SMC packages, this diode reduces the losses in high switching frequency operations.

Table 1: Device summary

Symbol	Value
$I_{F(AV)}$	2 A
V_{RRM}	1200 V
T_j	175 °C
V_F (typ.)	1.0 V
t_{rr} (max.)	75 ns

Features

- Low forward voltage drop
- High reliability
- High surge current capability
- Soft switching for reduced EMI disturbances
- Planar technology

1 Characteristics

Table 2: Absolute ratings (limiting values per diode at 25 °C, unless otherwise specified)

Symbol	Parameter		Value	Unit	
V _{RRM}	Repetitive peak reverse voltage		1200	V	
V _(RMS)	RMS voltage		850	V	
I _{F(AV)}	Average forward current $\delta = 0.5$, square wave	SMB	T _{lead} = 90 °C	2	A
		SMC	T _{lead} = 105 °C		
I _{F(RMS)}	RMS forward current		10	A	
I _{FSM}	Forward surge current t _p = 8.3 ms		40		
T _{stg}	Storage temperature range		-50 to +175	°C	
T _j	Maximum operating junction temperature		175	°C	

Table 3: Thermal parameters

Symbol	Parameter	Maximum	Unit
R _{th(j-l)}	Junction to lead	SMB	25
		SMC	20

Table 4: Static electrical characteristics (per diode)

Symbol	Parameter	Test conditions		Min.	Typ.	Max.	Unit
I _R	Reverse leakage current	T _j = 25 °C	V _R = V _{RRM}	-		10	µA
		T _j = 125 °C		-		100	
V _F	Forward voltage drop	T _j = 25 °C	I _F = 2 A	-		1.75	V
		T _j = 125 °C		-	1.07	1.50	
		T _j = 150 °C		-	1.0	-	

To evaluate the conduction losses, use the following equation:

$$P = 1.26 \times I_{F(AV)} + 0.12 \times I_{F(RMS)}^2$$

Table 5: Dynamic characteristics

Symbol	Parameter	Test conditions		Min.	Typ.	Max.	Unit
t _{rr}	Reverse recovery time	T _j = 25 °C	I _F = 1 A; dI _F /dt = -100 A/µs; V _R = 30 V	-	-	75	ns
t _{fr}	Forward recovery time	T _j = 25 °C	I _F = 2 A; dI _F /dt = 50 A/µs; V _{FR} = 1.1 × V _{Fmax}	-	-	500	
V _{FP}	Forward recovery voltage			-	-	30	V

1.1 Characteristics (curves)

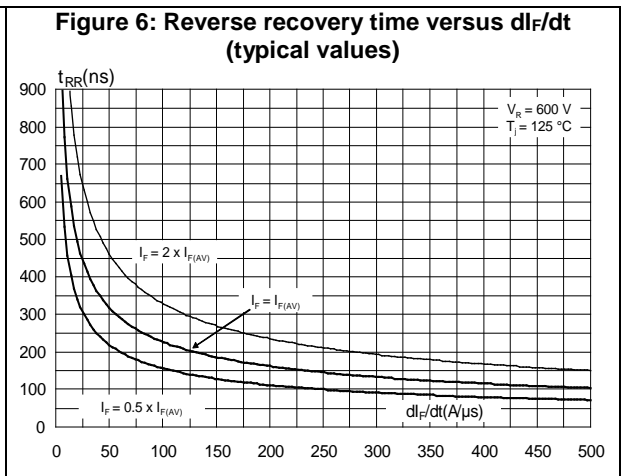
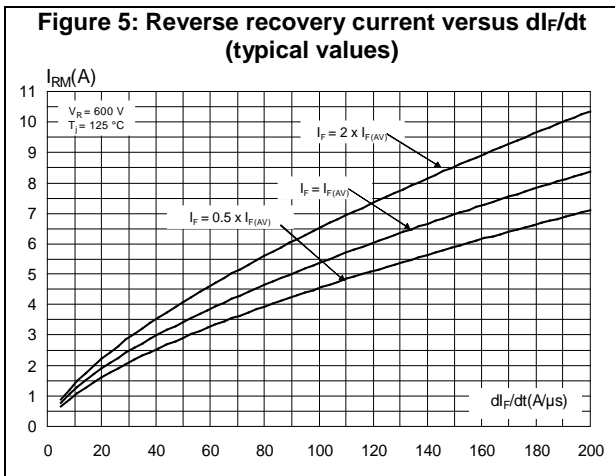
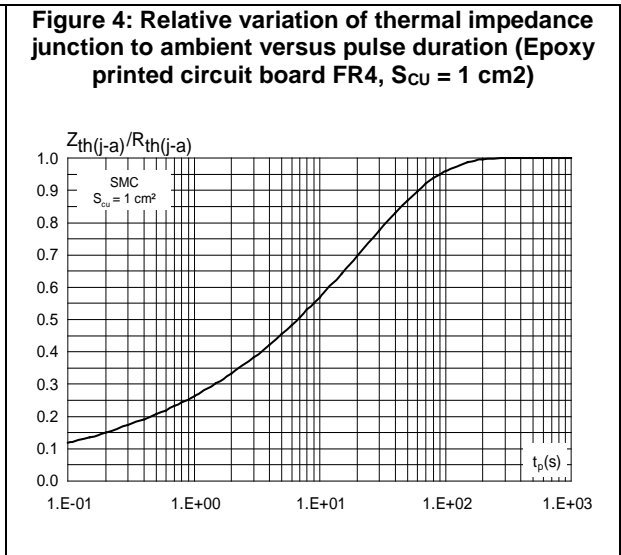
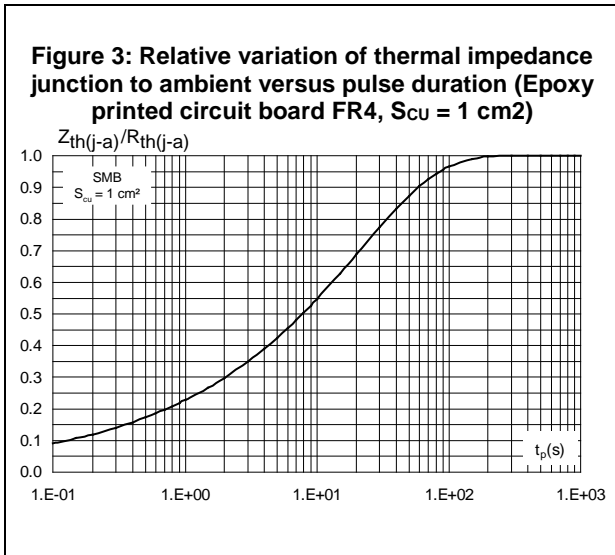
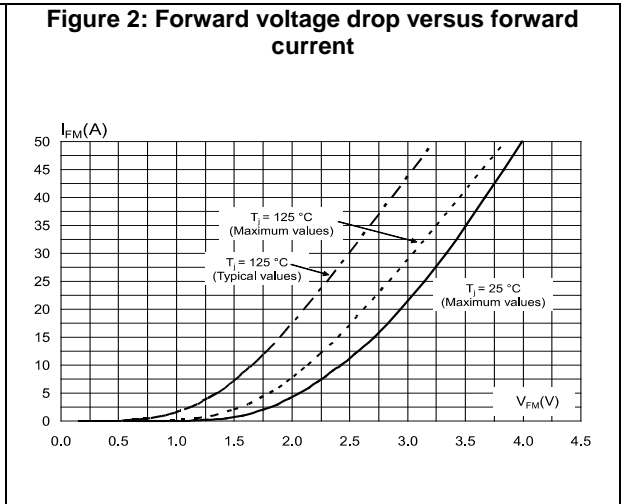
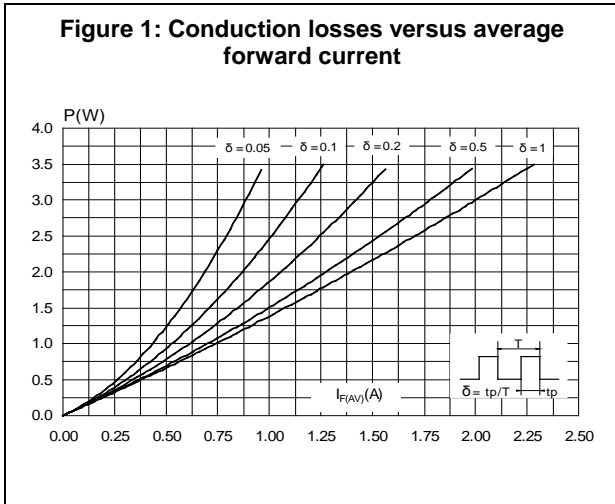

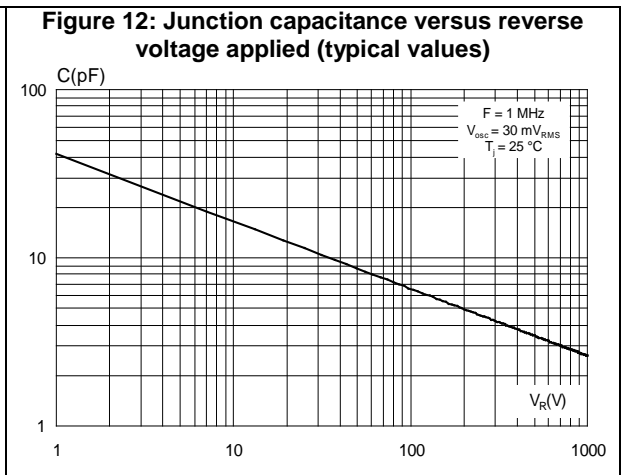
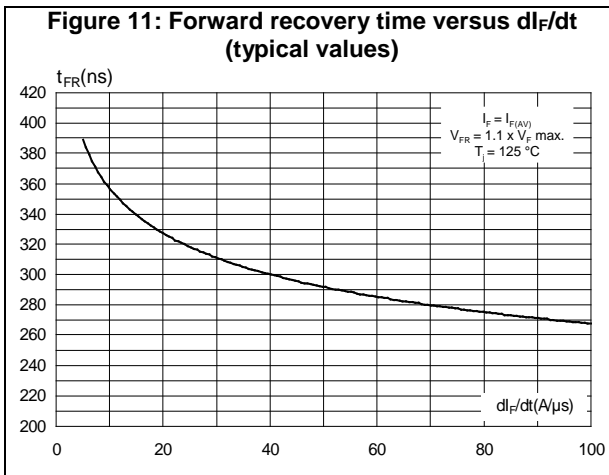
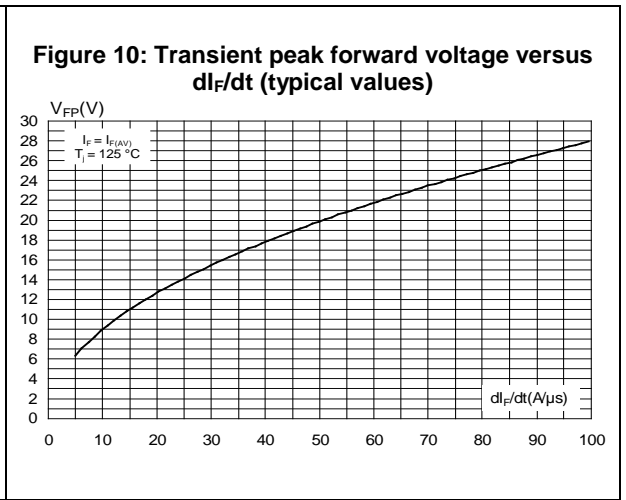
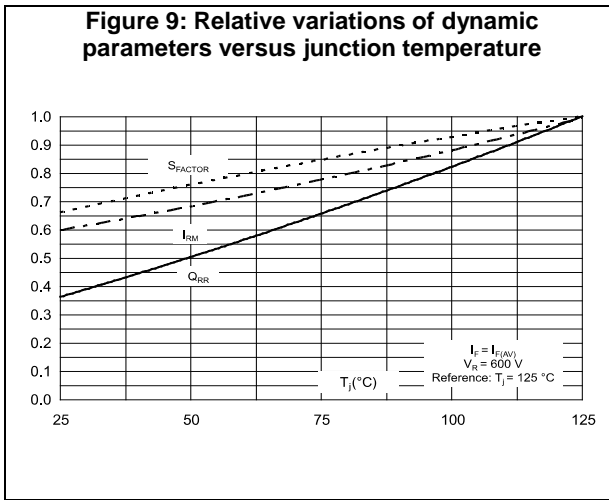
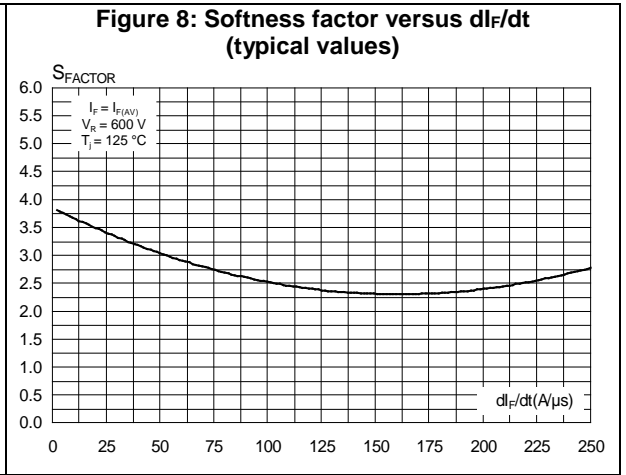
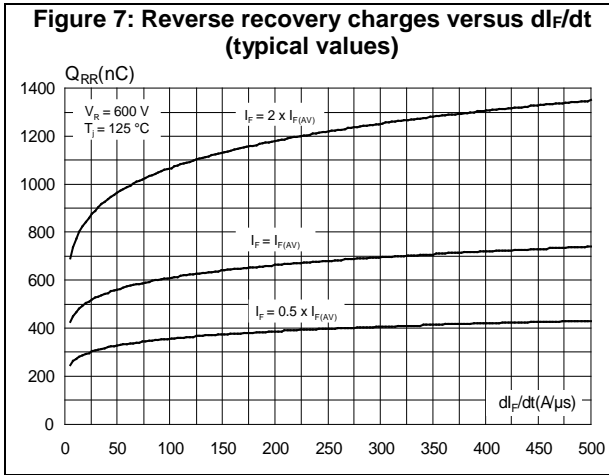
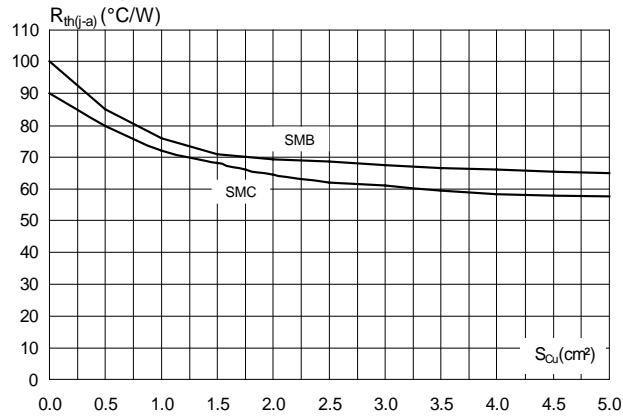

Figure 13: Thermal resistance junction to ambient versus copper surface under each lead
(Epoxy printed circuit board FR4, $e_{Cu} = 35 \mu m$)



2 Package information

In order to meet environmental requirements, ST offers these devices in different grades of ECOPACK® packages, depending on their level of environmental compliance. ECOPACK® specifications, grade definitions and product status are available at: www.st.com. ECOPACK® is an ST trademark.

- Epoxy meets UL94, V0

2.1 SMB package information

Figure 14: SMB package outline

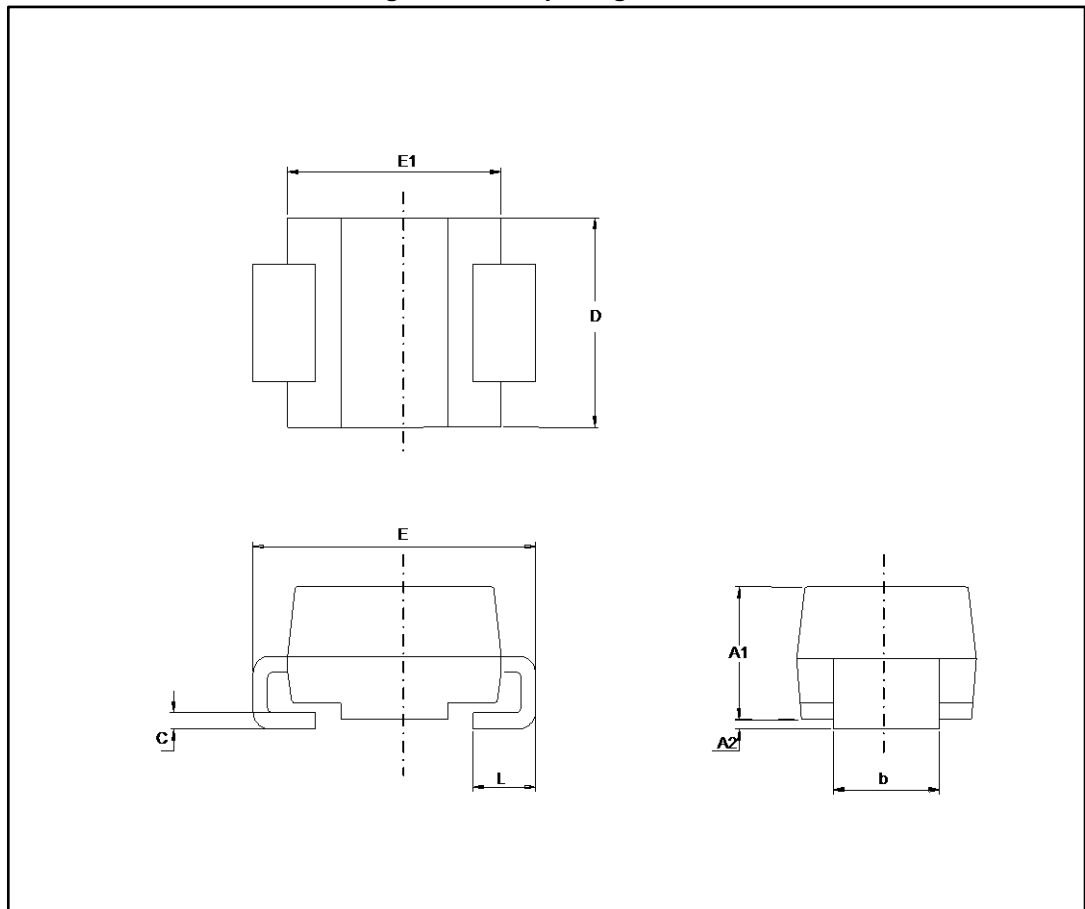
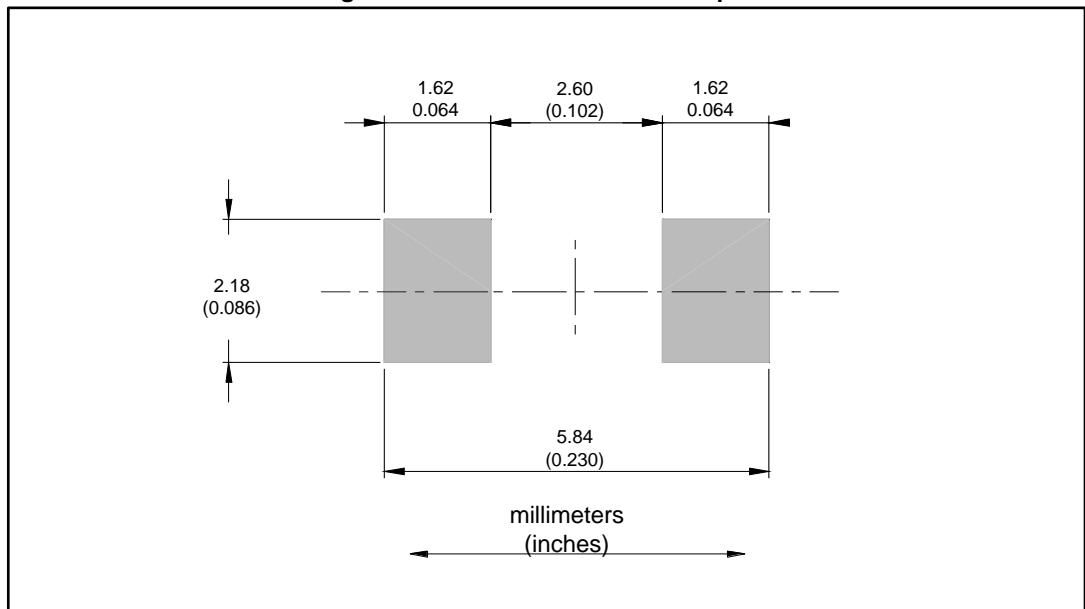

Table 6: SMB package mechanical data

Ref.	Dimensions			
	Millimeters		Inches	
	Min.	Max.	Min.	Max.
A1	1.90	2.45	0.0748	0.0965
A2	0.05	0.20	0.0020	0.0079
b	1.95	2.20	0.0768	0.0867
c	0.15	0.40	0.0059	0.0157
D	3.30	3.95	0.1299	0.1556
E	5.10	5.60	0.2008	0.2205
E1	4.05	4.60	0.1594	0.1811
L	0.75	1.50	0.0295	0.0591

Figure 15: SMB recommended footprint



2.2 SMC package information

Figure 16: SMC package outline

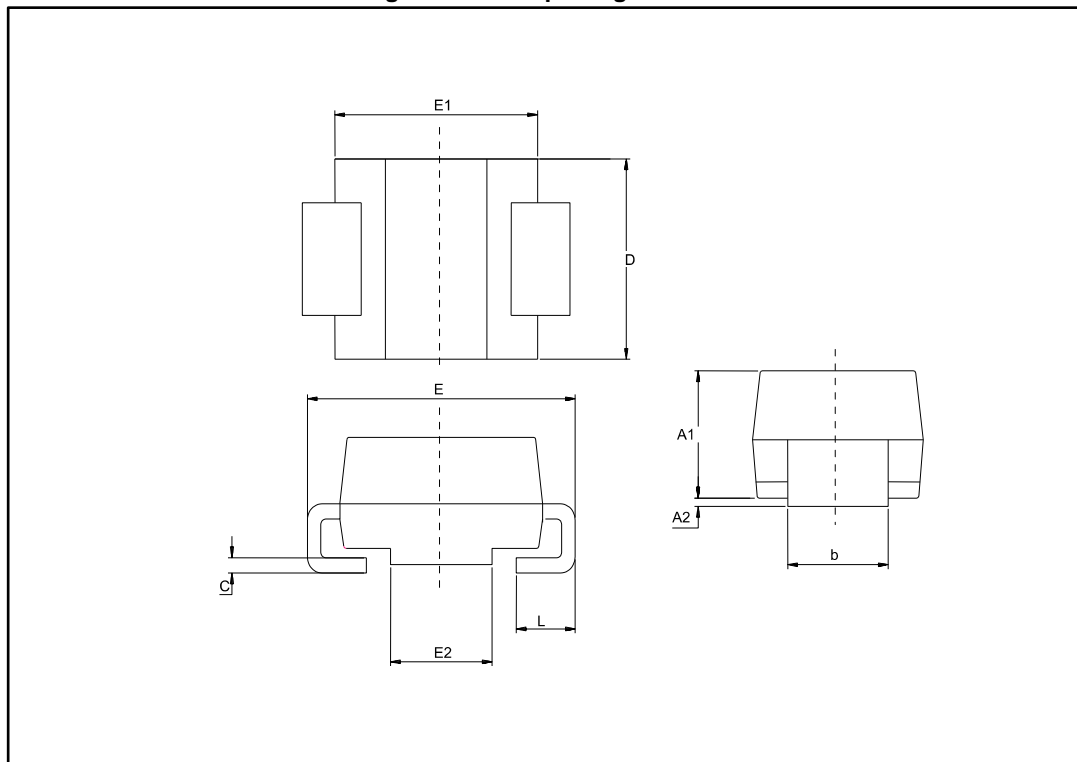
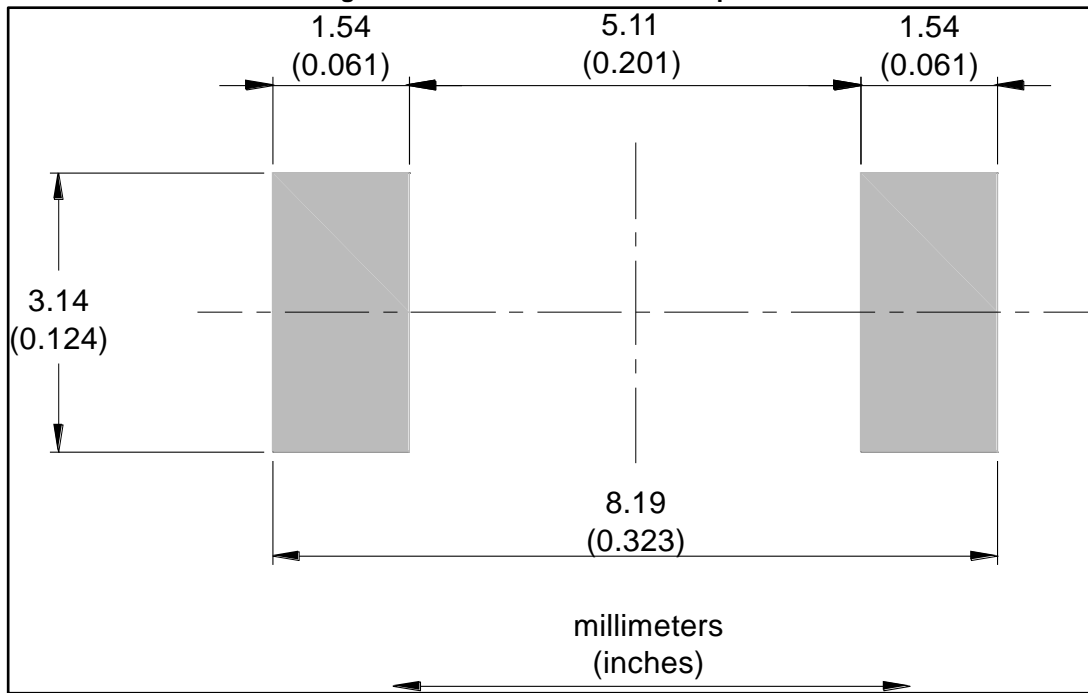

Table 7: SMC package mechanical data

Ref.	Dimensions			
	Millimeters		Inches	
	Min.	Max.	Min.	Max.
A1	1.90	2.45	0.0748	0.0965
A2	0.05	0.20	0.0020	0.0079
b	2.90	3.20	0.1142	0.1260
c	0.15	0.40	0.0059	0.0157
D	5.55	6.25	0.2185	0.2461
E	7.75	8.15	0.3051	0.3209
E1	6.60	7.15	0.2598	0.2815
E2	4.40	4.70	0.1732	0.1850
L	0.75	1.50	0.0295	0.0591

Figure 17: SMC recommended footprint



3 Ordering information

Table 8: Ordering information

Order code	Marking	Package	Weight	Base qty.	Delivery mode
STTH212U	U22	SMB	0.110 g	2500	Tape and reel
STTH212S	S12	SMC	0.243 g	2500	Tape and reel

4 Revision history

Table 9: Document revision history

Date	Revision	Changes
28-Jun-2005	1	First issue
12-Jun-2017	2	Updated cover image. Removed DO-201AD package.

IMPORTANT NOTICE – PLEASE READ CAREFULLY

STMicroelectronics NV and its subsidiaries ("ST") reserve the right to make changes, corrections, enhancements, modifications, and improvements to ST products and/or to this document at any time without notice. Purchasers should obtain the latest relevant information on ST products before placing orders. ST products are sold pursuant to ST's terms and conditions of sale in place at the time of order acknowledgement.

Purchasers are solely responsible for the choice, selection, and use of ST products and ST assumes no liability for application assistance or the design of Purchasers' products.

No license, express or implied, to any intellectual property right is granted by ST herein.

Resale of ST products with provisions different from the information set forth herein shall void any warranty granted by ST for such product.

ST and the ST logo are trademarks of ST. All other product or service names are the property of their respective owners.

Information in this document supersedes and replaces information previously supplied in any prior versions of this document.

© 2017 STMicroelectronics – All rights reserved