

FEATURES

- Automatically restarts a microprocessor after power failure
- Maintains reset for 150 ms after V_{CC} returns to an in-tolerance condition
- Reduces need for discrete components
- Precision temperature-compensated voltage reference and voltage sensor
- Low-cost TO-92 or space saving surface mount SOT-23 packages available
- Push-Pull output for low current operation
- Operating temperature -40°C to $+85^{\circ}\text{C}$

PIN ASSIGNMENT

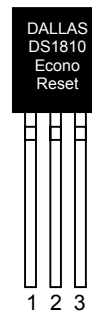

1 2 3



BOTTOM VIEW
 TO-92 PACKAGE
 See Mech.
 Drawings Section
 On Website

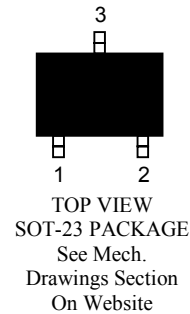

TOP VIEW
 SOT-23 PACKAGE
 See Mech.
 Drawings Section
 On Website

PIN DESCRIPTION

TO-92

1	$\overline{\text{RST}}$	Active Low Reset Output
2	V_{CC}	Power Supply
3	GND	Ground

SOT-23

1	$\overline{\text{RST}}$	Active Low Reset Output
2	V_{CC}	Power Supply
3	GND	Ground

DESCRIPTION

The DS1810 EconoReset uses a precision temperature reference and comparator circuit to monitor the status of the power supply (V_{CC}). When an out-of-tolerance condition is detected, an internal power-fail signal is generated which forces reset to the active state. When V_{CC} returns to an in-tolerance condition, the reset signal is kept in the active state for approximately 150 ms to allow the power supply and processor to stabilize.

OPERATION - POWER MONITOR

The DS1810 provides the function of detecting out-of-tolerance power supply conditions and warning a processor-based system of impending power failure. When V_{CC} is detected as out-of-tolerance, the \overline{RST} signal is asserted. On power-up, \overline{RST} is kept active for approximately 150 ms after the power supply has reached the selected tolerance. This allows the power supply and microprocessor to stabilize before \overline{RST} is released.

BLOCK DIAGRAM (PUSH-PULL OUTPUT) Figure 1

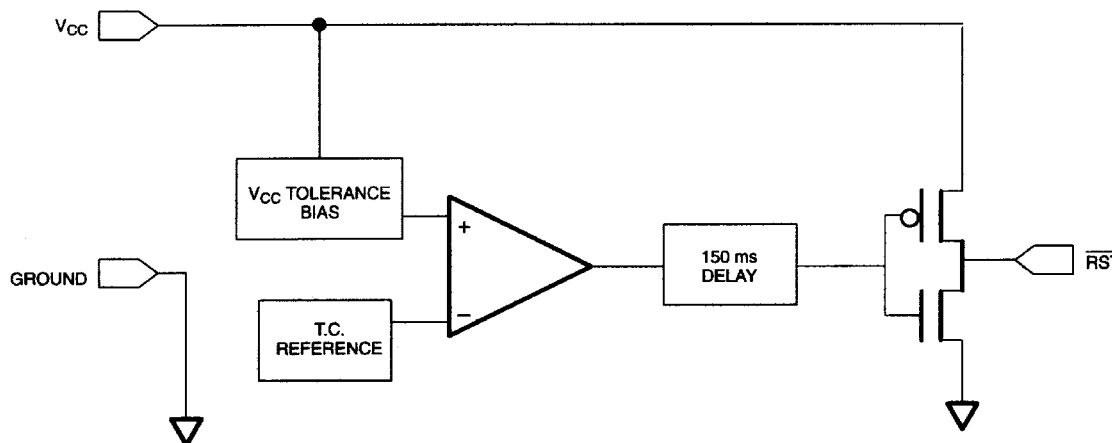

APPLICATION EXAMPLE Figure 2

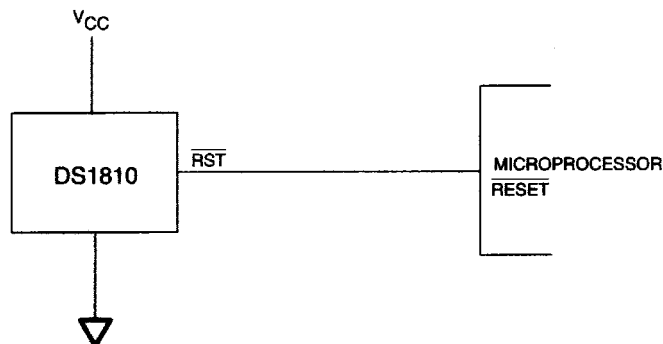

OUTPUT VALID CONDITIONS

All versions of the DS1810 can maintain a valid output as long as V_{CC} remains above 1.2 volt. However, the \overline{RST} outputs on the DS1810 use a push-pull structure which can maintain a valid output below 1.2 volts on an input. To sink current below 1.2 volts, a resistor can be connected from \overline{RST} to Ground (see Figure 3). This arrangement will maintain a valid value on the \overline{RST} outputs even if V_{CC} approaches 0 volts. During both power-up and -down this arrangement will draw current when \overline{RST} is in the high state. A value of about 100 k Ω should be adequate to maintain a valid condition.

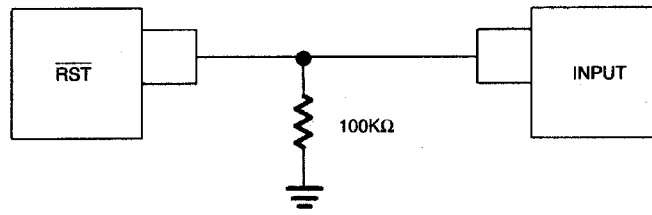
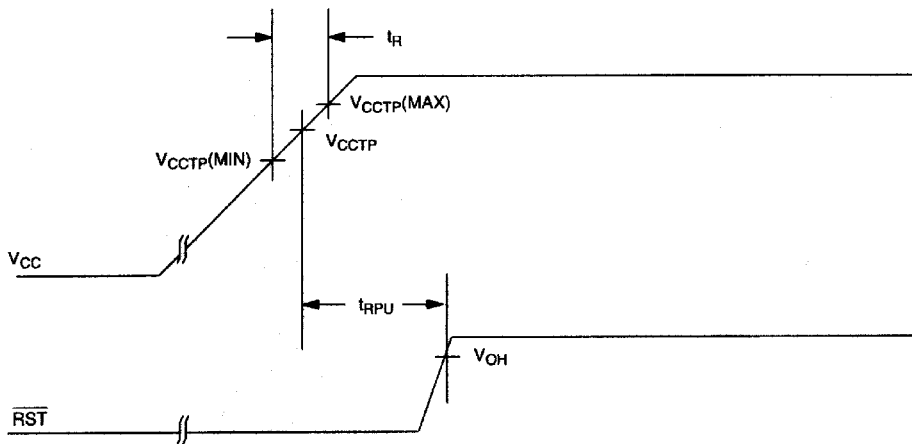
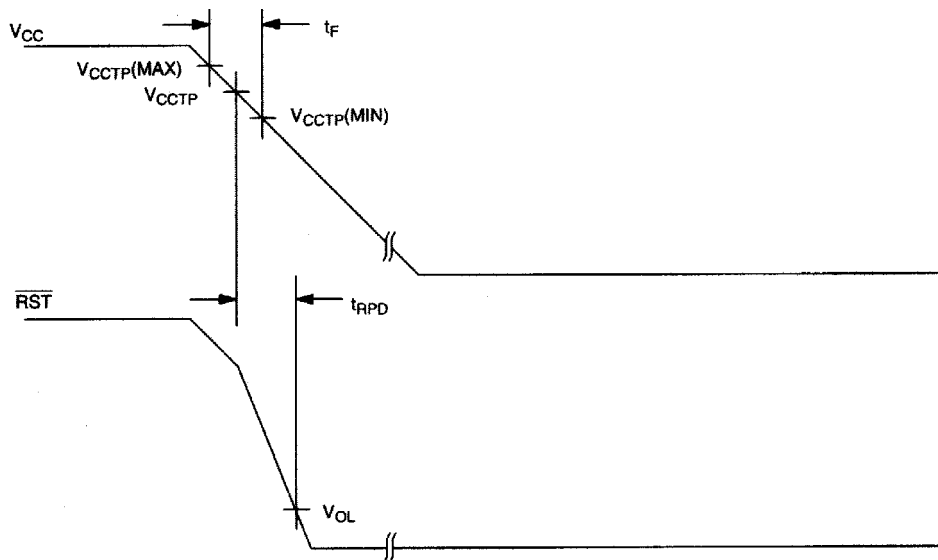
APPLICATION DIAGRAM: **$\overline{\text{RST}}$ VALID TO 0 VOLTS V_{CC} ON THE DS1810 Figure 3****TIMING DIAGRAM: POWER-UP Figure 4****TIMING DIAGRAM: POWER-DOWN Figure 5**

ABSOLUTE MAXIMUM RATINGS*

Voltage on V_{CC} Pin Relative to Ground	-0.5V to +7.0V
Voltage on RST Relative to Ground	-0.5V to $V_{CC} + 0.5V$
Operating Temperature	-40°C to +85°C
Storage Temperature	-55°C to +125°C
Soldering Temperature	260°C for 10 seconds

* This is a stress rating only and functional operation of the device at these or any other conditions above those indicated in the operation sections of this specification is not implied. Exposure to absolute maximum rating conditions for extended periods of time may affect reliability.

RECOMMENDED DC OPERATING CONDITIONS (-40°C to +85°C)

PARAMETER	SYMBOL	MIN	TYP	MAX	UNITS	NOTES
Supply Voltage	V_{CC}	1.2		5.5	V	1

DC ELECTRICAL CHARACTERISTICS (-40°C to +85°C; $V_{CC}=1.2V$ to 5.5V)

PARAMETER	SYMBOL	MIN	TYP	MAX	UNITS	NOTES
Output Voltage @ 0-500 μA	V_{OH}	$V_{CC}-0.5V$	$V_{CC}-0.1V$		V	1
Output Current @ 2.4V	I_{OH}		350		μA	2
Output Current @ 0.4V	I_{OL}	+10			mA	2
Operating Current $V_{CC} < 5.5$	I_{CC}		30	40	μA	3
V_{CC} Trip Point (DS1810-5)	V_{CCTP}	4.50	4.62	4.75	V	1
V_{CC} Trip Point (DS1810-10)	V_{CCTP}	4.25	4.37	4.49	V	1
V_{CC} Trip Point (DS1810-15)	V_{CCTP}	4.00	4.12	4.24	V	1
Output Capacitance	C_{OUT}			10	pF	

AC ELECTRICAL CHARACTERISTICS (-40°C to +85°C; $V_{CC}=1.2V$ to 5.5V)

PARAMETER	SYMBOL	MIN	TYP	MAX	UNITS	NOTES
RESET Active Time	t_{RST}	100	150	300	ms	
V_{CC} Detect to \overline{RST}	t_{RPD}		2	5	μs	
V_{CC} Slew Rate (V_{CCTP} (MAX) to V_{CCTP} (MIN))	t_f	300			μs	
V_{CC} Slew Rate (V_{CCTP} (MIN) to V_{CCTP} (MAX))	t_r	0			ns	
V_{CC} Detect to \overline{RST}	t_{RPU}	100	150	300	ms	4

NOTES:

1. All voltages are referenced to ground.
2. Measured with $V_{CC} \geq 2.7$ volts.
3. Measured with \overline{RST} output open.
4. $t_R = 5 \mu s$.

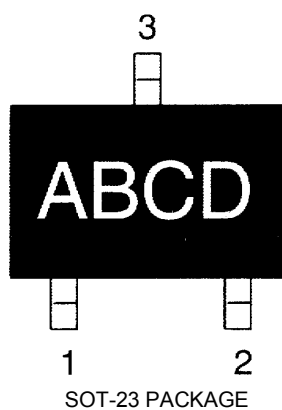
PART MARKING CODES

“A”, “B”, & “C” represent the device type.

810	-	DS1810
811	-	DS1811
812	-	DS1812
813	-	DS1813
815	-	DS1815
816	-	DS1816
817	-	DS1817
818	-	DS1818

“D” represents the device tolerance.

A	-	5%
B	-	10%
C	-	15%
D	-	20%

[DS1810](#)

Part Number Table

Notes:

1. See the [DS1810 QuickView Data Sheet](#) for further information on this product family or download the [DS1810 full data sheet](#) (PDF, 128kB).
2. Other options and links for purchasing parts are listed at: <http://www.maxim-ic.com/sales>.
3. [Didn't Find What You Need?](#) Ask our applications engineers. Expert assistance in finding parts, usually within one business day.
4. Part number suffixes: T or T&R = tape and reel; + = RoHS/lead-free; # = RoHS/lead-exempt. More: See [full data sheet](#) or [Part Naming Conventions](#).
5. * Some packages have variations, listed on the drawing. "PkgCode/Variation" tells which variation the product uses.

Part Number	Notes	Free Sample	Buy Direct	Package: TYPE PINS SIZE DRAWING CODE/VAR *	Temp	RoHS/Lead-Free? Materials Analysis
DS1810R-10+T&R-W				SOT23;3 pin;50 Dwg: 21-0051G (PDF) Use pkgcode/variation: U3+4*	-40C to +85C	RoHS/Lead-Free: Yes Materials Analysis
DS1810R-15+T&R	5V- 15%			SOT23;3 pin;50 Dwg: 21-0051G (PDF) Use pkgcode/variation: U3+4*	-40C to +85C	RoHS/Lead-Free: Yes Materials Analysis
DS1810R-5+T&R	5V-5%			SOT23;3 pin;50 Dwg: 21-0051G (PDF) Use pkgcode/variation: U3+4*	-40C to +85C	RoHS/Lead-Free: Yes Materials Analysis
DS1810R-15-U	5V- 15%			SOT23;3 pin;50 Dwg: 21-0051G (PDF) Use pkgcode/variation: U3-4*	-40C to +85C	RoHS/Lead-Free: No Materials Analysis

DS1810R-10-U	5V- 10%	SOT23;3 pin;50 Dwg: 21-0051G (PDF) Use pkgcode/variation: U3-4*	-40C to +85C RoHS/Lead-Free: No Materials Analysis
DS1810R-5-U	5V-5%	SOT23;3 pin;50 Dwg: 21-0051G (PDF) Use pkgcode/variation: U3-4*	-40C to +85C RoHS/Lead-Free: No Materials Analysis
DS1810R-15/T&R	5V- 15%	SOT23;3 pin;50 Dwg: 21-0051G (PDF) Use pkgcode/variation: U3-4*	-40C to +85C RoHS/Lead-Free: No Materials Analysis
DS1810R-10/T&R	5V- 10%	SOT23;3 pin;50 Dwg: 21-0051G (PDF) Use pkgcode/variation: U3-4*	-40C to +85C RoHS/Lead-Free: No Materials Analysis
DS1810R-5/T&R	5V-5%	SOT23;3 pin;50 Dwg: 21-0051G (PDF) Use pkgcode/variation: U3-4*	-40C to +85C RoHS/Lead-Free: No Materials Analysis
DS1810R-10-U+		SOT23;3 pin;50 Dwg: 21-0051G (PDF) Use pkgcode/variation: U3+4*	-40C to +85C RoHS/Lead-Free: Yes Materials Analysis
DS1810R-15-U+		SOT23;3 pin;50 Dwg: 21-0051G (PDF) Use pkgcode/variation: U3+4*	-40C to +85C RoHS/Lead-Free: Yes Materials Analysis
DS1810R-5-U+		SOT23;3 pin;50 Dwg: 21-0051G (PDF) Use pkgcode/variation: U3+4*	-40C to +85C RoHS/Lead-Free: Yes Materials Analysis
DS1810R-10+T&R	5V- 10%	SOT23;3 pin;50 Dwg: 21-0051G (PDF) Use pkgcode/variation: U3+4*	-40C to +85C RoHS/Lead-Free: Yes Materials Analysis
DS1810-15+T&R	5V- 15%	TO92;3 pin;185 Dwg: 56-G0006-003A (PDF) Use pkgcode/variation: Q3+4*	-40C to +85C RoHS/Lead-Free: Yes Materials Analysis
DS1810-5+T&R	5V-5%	TO92;3 pin;185 Dwg: 56-G0006-003A (PDF) Use pkgcode/variation: Q3+4*	-40C to +85C RoHS/Lead-Free: Yes Materials Analysis

DS1810-10+T&R	5V- 10%	TO92;3 pin;185 Dwg: 56-G0006-003A (PDF) Use pkgcode/variation: Q3+4*	-40C to +85C RoHS/Lead-Free: Yes Materials Analysis
DS1810-15/T&R	5V- 15%	TO92;3 pin;185 Dwg: 56-G0006-003A (PDF) Use pkgcode/variation: Q3-4*	-40C to +85C RoHS/Lead-Free: No Materials Analysis
DS1810-10/T&R	5V- 10%	TO92;3 pin;185 Dwg: 56-G0006-003A (PDF) Use pkgcode/variation: Q3-4*	-40C to +85C RoHS/Lead-Free: No Materials Analysis
DS1810-5/T&R	5V-5%	TO92;3 pin;185 Dwg: 56-G0006-003A (PDF) Use pkgcode/variation: Q3-4*	-40C to +85C RoHS/Lead-Free: No Materials Analysis
DS1810-15	5V- 10% Monitor	TO92;3 pin;185 Dwg: 56-G0006-001A (PDF) Use pkgcode/variation: Q3-1*	-40C to +85C RoHS/Lead-Free: No Materials Analysis
DS1810-10	5V- 15% Monitor	TO92;3 pin;185 Dwg: 56-G0006-001A (PDF) Use pkgcode/variation: Q3-1*	-40C to +85C RoHS/Lead-Free: No Materials Analysis
DS1810-5	5V-5% Monitor	TO92;3 pin;185 Dwg: 56-G0006-001A (PDF) Use pkgcode/variation: Q3-1*	-40C to +85C RoHS/Lead-Free: No Materials Analysis
DS1810-15+		TO92;3 pin;185 Dwg: 56-G0006-001A (PDF) Use pkgcode/variation: Q3+1*	-40C to +85C RoHS/Lead-Free: Yes Materials Analysis
DS1810-5+		TO92;3 pin;185 Dwg: 56-G0006-001A (PDF) Use pkgcode/variation: Q3+1*	-40C to +85C RoHS/Lead-Free: Yes Materials Analysis
DS1810-10+		TO92;3 pin;185 Dwg: 56-G0006-001A (PDF) Use pkgcode/variation: Q3+1*	-40C to +85C RoHS/Lead-Free: Yes Materials Analysis

[Didn't Find What You Need?](#)

[CONTACT US: SEND US AN EMAIL](#)

Copyright 2007 by Maxim Integrated Products, Dallas Semiconductor • [Legal Notices](#) • [Privacy Policy](#)