



Is Now Part of



**ON Semiconductor®**

To learn more about ON Semiconductor, please visit our website at  
[www.onsemi.com](http://www.onsemi.com)

Please note: As part of the Fairchild Semiconductor integration, some of the Fairchild orderable part numbers will need to change in order to meet ON Semiconductor's system requirements. Since the ON Semiconductor product management systems do not have the ability to manage part nomenclature that utilizes an underscore (\_), the underscore (\_) in the Fairchild part numbers will be changed to a dash (-). This document may contain device numbers with an underscore (\_). Please check the ON Semiconductor website to verify the updated device numbers. The most current and up-to-date ordering information can be found at [www.onsemi.com](http://www.onsemi.com). Please email any questions regarding the system integration to [Fairchild\\_questions@onsemi.com](mailto:Fairchild_questions@onsemi.com).

ON Semiconductor and the ON Semiconductor logo are trademarks of Semiconductor Components Industries, LLC dba ON Semiconductor or its subsidiaries in the United States and/or other countries. ON Semiconductor owns the rights to a number of patents, trademarks, copyrights, trade secrets, and other intellectual property. A listing of ON Semiconductor's product/patent coverage may be accessed at [www.onsemi.com/site/pdf/Patent-Marking.pdf](http://www.onsemi.com/site/pdf/Patent-Marking.pdf). ON Semiconductor reserves the right to make changes without further notice to any products herein. ON Semiconductor makes no warranty, representation or guarantee regarding the suitability of its products for any particular purpose, nor does ON Semiconductor assume any liability arising out of the application or use of any product or circuit, and specifically disclaims any and all liability, including without limitation special, consequential or incidental damages. Buyer is responsible for its products and applications using ON Semiconductor products, including compliance with all laws, regulations and safety requirements or standards, regardless of any support or applications information provided by ON Semiconductor. "Typical" parameters which may be provided in ON Semiconductor data sheets and/or specifications can and do vary in different applications and actual performance may vary over time. All operating parameters, including "Typicals" must be validated for each customer application by customer's technical experts. ON Semiconductor does not convey any license under its patent rights nor the rights of others. ON Semiconductor products are not designed, intended, or authorized for use as a critical component in life support systems or any FDA Class 3 medical devices or medical devices with a same or similar classification in a foreign jurisdiction or any devices intended for implantation in the human body. Should Buyer purchase or use ON Semiconductor products for any such unintended or unauthorized application, Buyer shall indemnify and hold ON Semiconductor and its officers, employees, subsidiaries, affiliates, and distributors harmless against all claims, costs, damages, and expenses, and reasonable attorney fees arising out of, directly or indirectly, any claim of personal injury or death associated with such unintended or unauthorized use, even if such claim alleges that ON Semiconductor was negligent regarding the design or manufacture of the part. ON Semiconductor is an Equal Opportunity/Affirmative Action Employer. This literature is subject to all applicable copyright laws and is not for resale in any manner.

## NC7WBD3125

# 2-Bit Low Power Bus Switch with Level Shifting

### General Description

The NC7WBD3125 is a 2-bit ultra high-speed CMOS FET bus switch with enhanced level shifting circuitry and with TTL-compatible active LOW control inputs. The low On Resistance of the switch allows inputs to be connected to outputs with minimal propagation delay and without generating additional ground bounce noise. The device is organized as a 2-bit switch with independent bus enable ( $\overline{OE}$ ) controls. When  $\overline{OE}$  is LOW, the switch is ON and Port A is connected to Port B. When  $\overline{OE}$  is HIGH, the switch is OPEN and a high-impedance state exists between the two ports. Reduced voltage drive to the gate of the FET switch permits nominal level shifting of 5V to 3V through the switch. Control inputs tolerate voltages up to 5.5V independent of  $V_{CC}$ .

### Features

- Space saving US8 surface mount package
- MicroPak™ Pb-Free leadless package
- Typical  $3\Omega$  switch resistance at 5.0V  $V_{CC}$ ,  $V_{IN} = 0V$
- Level shift facilitates 5V to 3.3V interfacing
- Minimal propagation delay through the switch
- Power down high impedance input/output
- Zero bounce in flow through mode
- TTL compatible active LOW control inputs
- Control inputs are overvoltage tolerant
- Bus switch replacement for x125 logic part

### Ordering Code:

Order Number	Package Number	Package Code Top Mark	Package Description	Supplied As
NC7WBD3125K8X	MAB08A	WB5D	8-Lead US8, JEDEC MO-187, Variation CA 3.1mm Wide	3k Units on Tape and Reel
NC7WBD3125L8X (Preliminary)	MAC08A	T9	Pb-Free 8-Lead MicroPak, 1.6 mm Wide	5k Units on Tape and Reel

Pb-Free package per JEDEC J-STD-020B.

MicroPak™ is a trademark of Fairchild Semiconductor Corporation.

### Logic Diagram

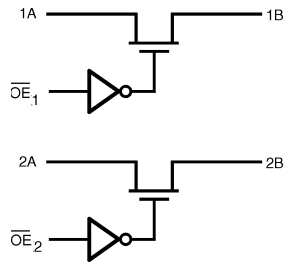

### Pin Descriptions

Pin Name	Description
A	Bus A Switch I/O
B	Bus B Switch I/O
OE	Bus Enable Input

### Function Table

Bus Enable Input (OE)	Function
L	B Connected to A
H	Disconnected

H = HIGH Logic Level  
L = LOW Logic Level

### Connection Diagrams

Pin Assignments for US8

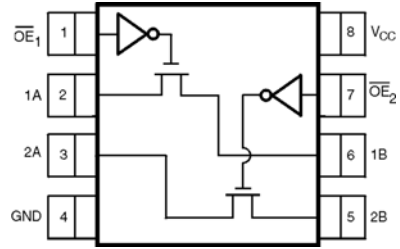

(Top View)

Pin One Orientation Diagram

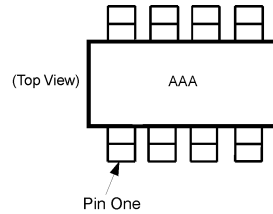

AAA represents Product Code Top Mark - see ordering code

**Note:** Orientation of Top Mark determines Pin One location. Read the top product code mark left to right, Pin One is the lower left pin (see diagram).

Pad Assignments for MicroPak

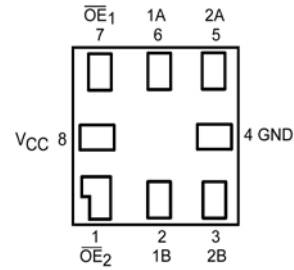

(Top Through View)

## Absolute Maximum Ratings (Note 1)

Supply Voltage ( $V_{CC}$ )	-0.5V to +7.0V
DC Switch Voltage ( $V_S$ )	-0.5V to +7.0V
DC Output Voltage ( $V_{IN}$ ) (Note 2)	-0.5V to +7.0V
DC Input Diode Current	
( $I_{IK}$ ) $V_{IN} < 0V$	-50 mA
DC Output ( $I_{OUT}$ ) Current	128 mA
DC $V_{CC}$ or Ground Current	
( $I_{CC}/I_{GND}$ )	±100 mA
Storage Temperature Range ( $T_{STG}$ )	-65°C to +150°C
Junction Temperature under Bias ( $T_J$ )	+150°C
Lead Temperature ( $T_L$ )	
(Soldering, 10 Seconds)	+260°C
Power Dissipation ( $P_D$ ) @ +85°C	250 mW

## Recommended Operating Conditions (Note 3)

Supply Operating ( $V_{CC}$ )	4.5V to 5.5V
Control Input Voltage ( $V_{IN}$ )	0V to 5.5V
Switch Input Voltage ( $V_{IN}$ )	0V to 5.5V
Switch Output Voltage ( $V_{OUT}$ )	0V to 5.5V
Operating Temperature ( $T_A$ )	-40°C to +85°C
Input Rise and Fall Time ( $t_r, t_f$ )	
Control Input	0 ns/V to 5 ns/V
Switch I/O	0 ns/V to DC
Thermal Resistance ( $\theta_{JA}$ )	250°C/W

**Note 1:** The "Absolute Maximum Ratings" are those values beyond which the safety of the device cannot be guaranteed. The device should not be operated at these limits. The parametric values defined in the Electrical Characteristics tables are not guaranteed at the absolute maximum ratings. The "Recommended Operating Conditions" table will define the conditions for actual device operation.

**Note 2:** The input and output negative voltage ratings may be exceeded if the input and output diode current ratings are observed.

**Note 3:** Unused logic inputs must be held HIGH or LOW. They may not float.

## DC Electrical Characteristics

Symbol	Parameter	$V_{CC}$ (V)	$T_A = -40^\circ\text{C to } +85^\circ\text{C}$			Units	Conditions
			Min	Typ	Max		
$V_{IK}$	Clamp Diode Voltage	4.5		-1.2		V	$I_{IN} = -18 \text{ mA}$
$V_{IH}$	HIGH Level Input Voltage	4.5 to 5.5	2.0			V	
$V_{IL}$	LOW Level Input Voltage	4.5 to 5.5			0.8	V	
$V_{OH}$	HIGH Level Output Voltage	4.5 to 5.5	See Figure 3			V	$V_{IN} = V_{CC}$
$I_{IN}$	Input Leakage Current	5.5			±1.0	µA	$0 \leq V_{IN} \leq 5.5V$
$I_{OFF}$	Power OFF Leakage Current	5.5			±1.0	µA	$0 \leq A, B \leq V_{CC}$
$R_{ON}$	Switch On Resistance (Note 4)	4.5		3.0	7.0	Ω	$V_{IN} = 0V, I_{IN} = 64 \text{ mA}$
		4.5		3.0	7.0		$V_{IN} = 0V, I_{IN} = 30 \text{ mA}$
		4.5		15.0	50.0		$V_{IN} = 2.4V, I_{IN} = 15 \text{ mA}$
$I_{CC}$	Quiescent Supply Current	5.5		1.1	1.5	mA	$V_{IN} = V_{CC}$ or GND, $I_{OUT} = 0$
							10.0
$\Delta I_{CC}$	Increase in $I_{CC}$ per Input (Note 5)	5.5		1.0	2.5	mA	$V_{IN} = 3.4V$ , One $\overline{OE}$ Input only, Other $\overline{OE} = V_{CC}$

**Note 4:** Measured by the voltage drop between A and B pins at the indicated current through the switch. On Resistance is determined by the lower of the voltages on the two (A or B) pins.

**Note 5:** Per TTL driven input ( $V_{IN} = 3.4V$ , control input only). A and B pins do not contribute to  $I_{CC}$ .

## AC Electrical Characteristics

Symbol	Parameter	V <sub>CC</sub> (V)	T <sub>A</sub> = -40°C to +85°C, C <sub>L</sub> = 50 pF, R <sub>U</sub> = R <sub>D</sub> = 500Ω			Units	Conditions	Figure Number
			Min	Typ	Max			
t <sub>PHL</sub> , t <sub>PLH</sub>	Propagation Delay Bus-to-Bus (Note 6)	4.5 to 5.5			0.25	ns	V <sub>I</sub> = OPEN	Figures 1, 2
t <sub>PZL</sub> , t <sub>PZH</sub>	Output Enable Time	4.5 to 5.5	1.0	3.5	5.8	ns	V <sub>I</sub> = 7V for t <sub>PZL</sub> V <sub>I</sub> = 0V for t <sub>PZH</sub>	Figures 1, 2
t <sub>PLZ</sub> , t <sub>PHZ</sub>	Output Disable Time	4.5 to 5.5	0.8	3.0	4.8	ns	V <sub>I</sub> = 7V for t <sub>PLZ</sub> V <sub>I</sub> = 0V for t <sub>PHZ</sub>	Figures 1, 2

**Note 6:** This parameter is guaranteed. The bus switch contributes no propagation delay other than the RC delay of the typical On Resistance of the switch and the 50 pF load capacitance, when driven by an ideal voltage source (zero output impedance). The specified limit is calculated on this basis.

## Capacitance

Symbol	Parameter	Typ	Max	Units	Conditions
C <sub>IN</sub>	Control Pin Input Capacitance	2.5		pF	V <sub>CC</sub> = 0V
C <sub>I/O</sub> (OFF)	Port OFF Capacitance	6.0		pF	V <sub>CC</sub> = 5.0V = $\overline{OE}$
C <sub>I/O</sub> (ON)	Port ON Capacitance	12.0		pF	V <sub>CC</sub> = 5.0V, $\overline{OE}$ = 0V

## AC Loading and Waveforms

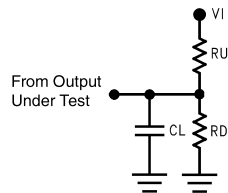

Input driven by 50Ω source terminated in 50Ω

C<sub>L</sub> includes load and stray capacitance

Input PRR = 1.0 MHz; t<sub>W</sub> = 500 ns

FIGURE 1. AC Test Circuit

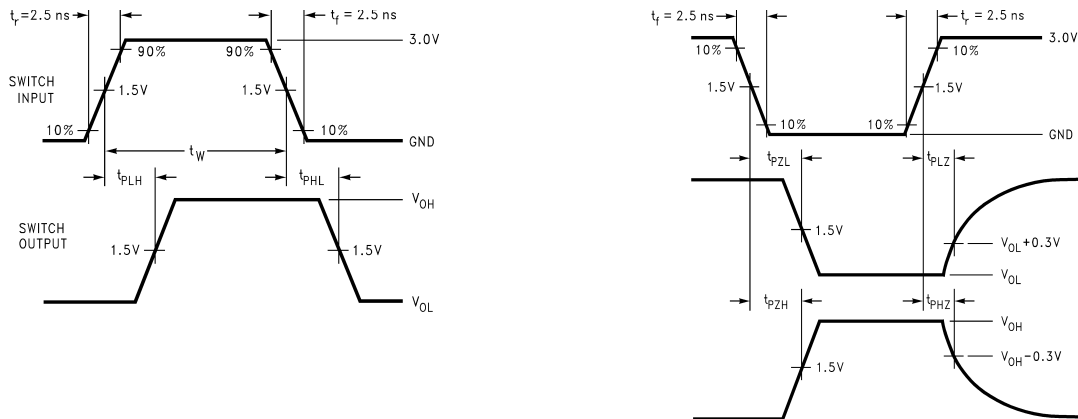

FIGURE 2. AC Waveforms

## DC Electrical Characteristics

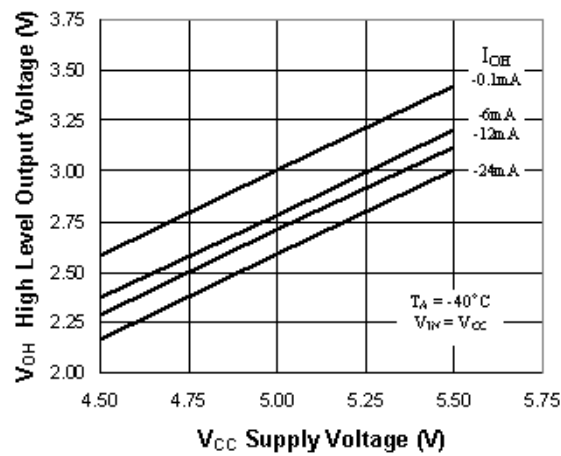
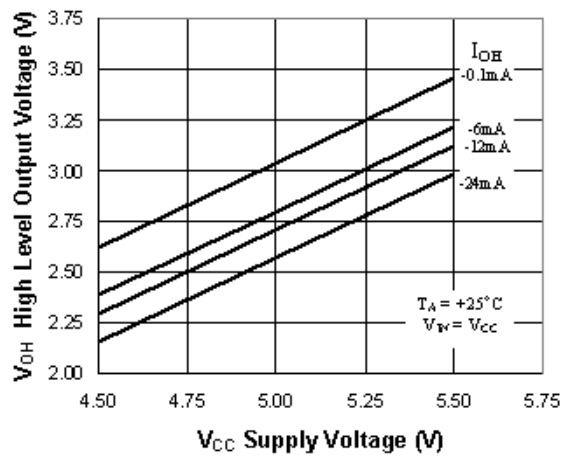
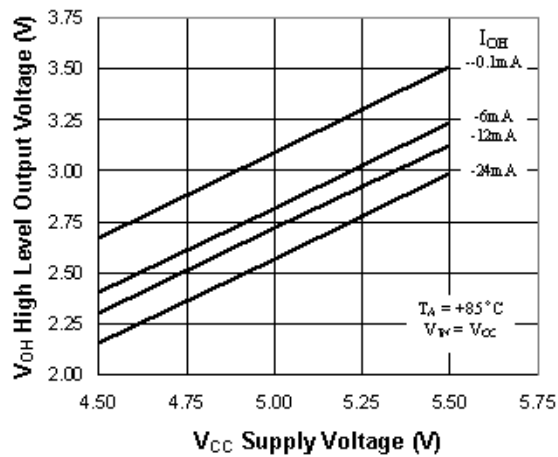

FIGURE 3. Typical High Level Output Voltage vs. Supply Voltage

# Tape and Reel Specification

## TAPE FORMAT for US8

Package Designator	Tape Section	Number Cavities	Cavity Status	Cover Tape Status
K8X	Leader (Start End)	125 (typ)	Empty	Sealed
	Carrier	250	Filled	Sealed
	Trailer (Hub End)	75 (typ)	Empty	Sealed

## TAPE DIMENSIONS inches (millimeters)

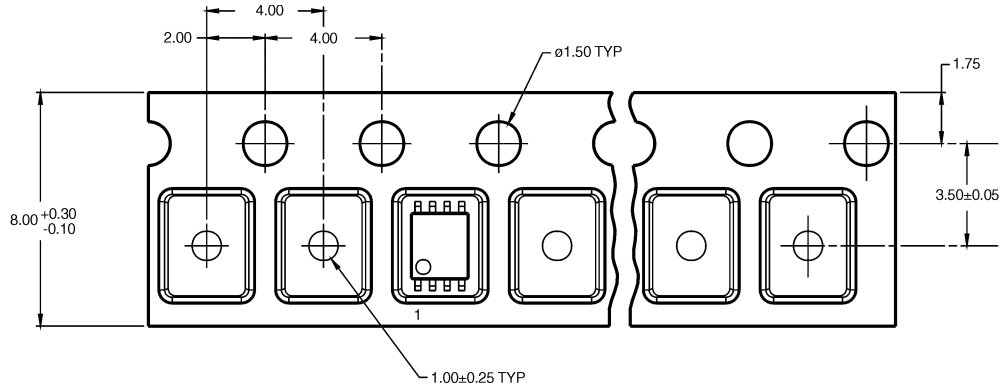

## TAPE FORMAT for MicroPak

Package Designator	Tape Section	Number Cavities	Cavity Status	Cover Tape Status
L8X	Leader (Start End)	125 (typ)	Empty	Sealed
	Carrier	250	Filled	Sealed
	Trailer (Hub End)	75 (typ)	Empty	Sealed

## TAPE DIMENSIONS inches (millimeters)

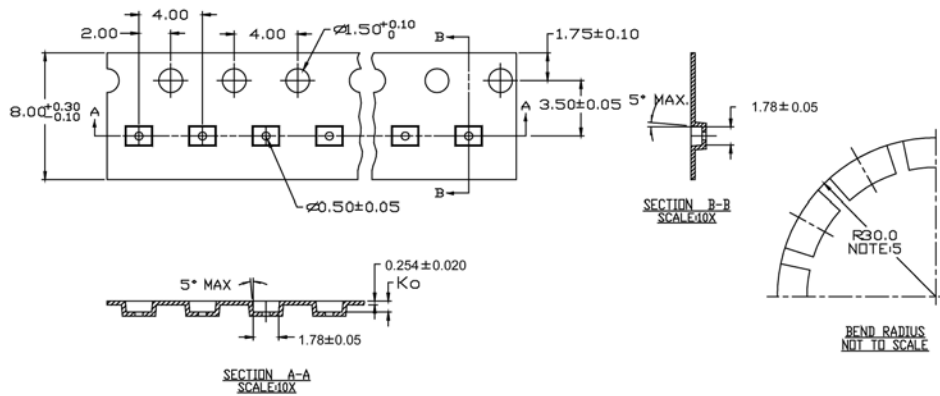

REEL DIMENSIONS inches (millimeters)

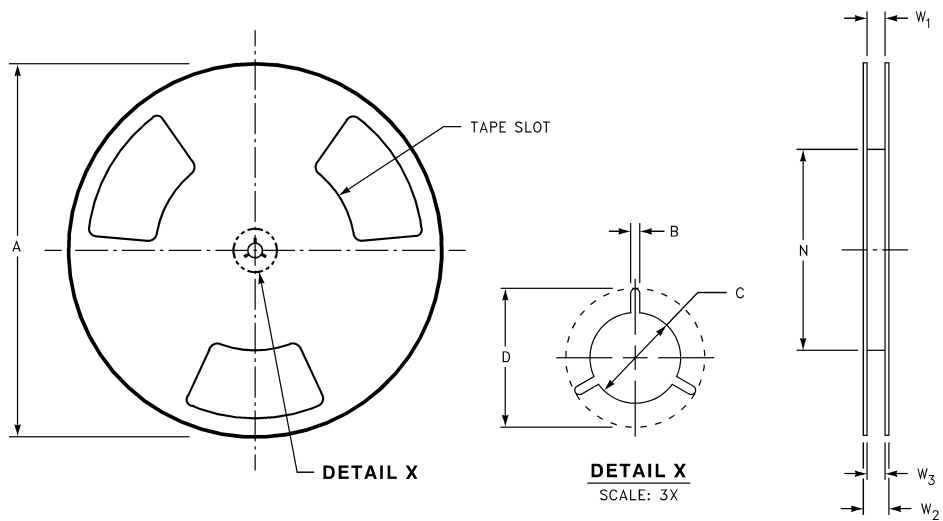

Tape Size	A	B	C	D	N	W1	W2	W3
8 mm	7.0 (177.8)	0.059 (1.50)	0.512 (13.00)	0.795 (20.20)	2.165 (55.00)	0.331 + 0.059/-0.000 (8.40 + 1.50/-0.00)	0.567 (14.40)	W1 + 0.078/-0.039 (W1 + 2.00/-1.00)



**Physical Dimensions** inches (millimeters) unless otherwise noted

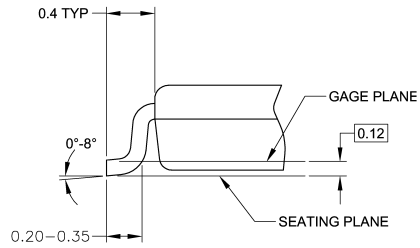
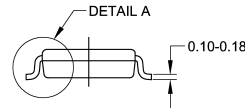
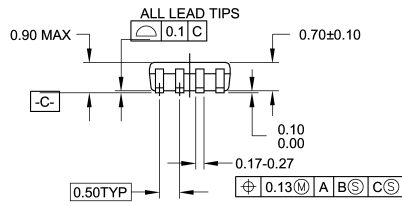
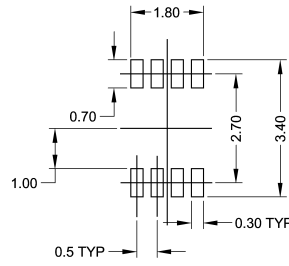
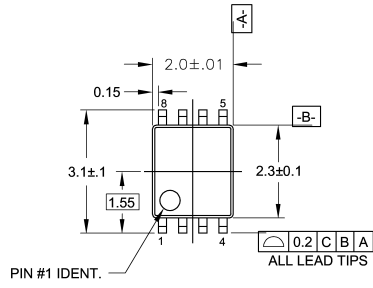

NOTES:

- A. CONFORMS TO JEDEC REGISTRATION MO-187
- B. DIMENSIONS ARE IN MILLIMETERS.
- C. DIMENSIONS ARE EXCLUSIVE OF BURRS, MOLD FLASH, AND TIE BAR EXTRUSIONS.
- D. DIMENSIONS AND TOLERANCES PER ANSI Y14.5M, 1982.

MAB08AREVC

**8-Lead US8, JEDEC MO-187, Variation CA 3.1mm Wide  
Package Number MAB08A**

**Physical Dimensions** inches (millimeters) unless otherwise noted (Continued)

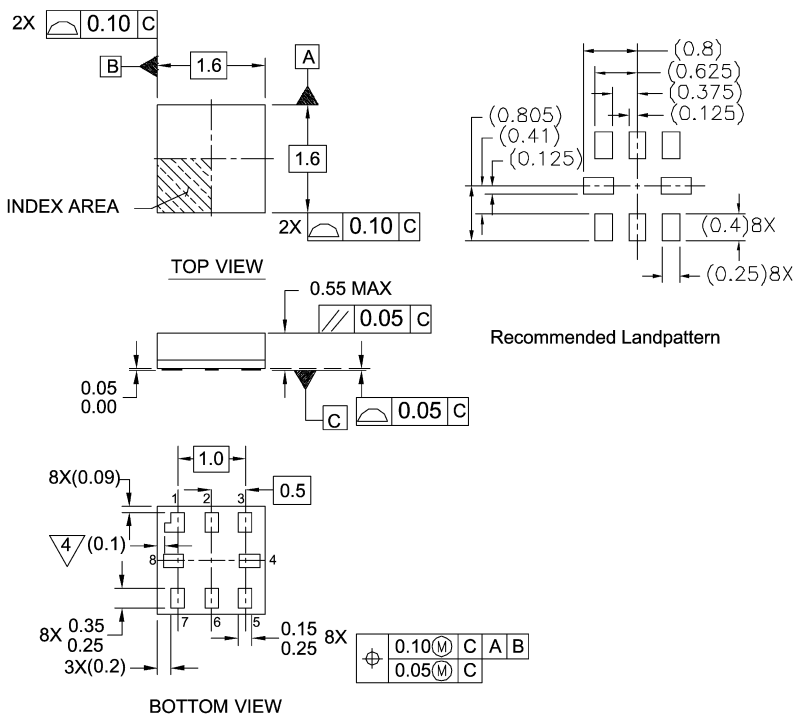

Notes:

1. PACKAGE CONFORMS TO JEDEC MO-255 VARIATION UAAD
2. DIMENSIONS ARE IN MILLIMETERS
3. DRAWING CONFORMS TO ASME Y.14M-1994
4. PIN 1 FLAG, END OF PACKAGE OFFSET.

MAC08AREVC

**Pb-Free 8-Lead MicroPak, 1.6 mm Wide  
Package Number MAC08A**

**DISCLAIMER**

FAIRCHILD SEMICONDUCTOR RESERVES THE RIGHT TO MAKE CHANGES WITHOUT FURTHER NOTICE TO ANY PRODUCTS HEREIN TO IMPROVE RELIABILITY, FUNCTION OR DESIGN. FAIRCHILD DOES NOT ASSUME ANY LIABILITY ARISING OUT OF THE APPLICATION OR USE OF ANY PRODUCT OR CIRCUIT DESCRIBED HEREIN; NEITHER DOES IT CONVEY ANY LICENSE UNDER ITS PATENT RIGHTS, NOR THE RIGHTS OF OTHERS.

**LIFE SUPPORT POLICY**

FAIRCHILD'S PRODUCTS ARE NOT AUTHORIZED FOR USE AS CRITICAL COMPONENTS IN LIFE SUPPORT DEVICES OR SYSTEMS WITHOUT THE EXPRESS WRITTEN APPROVAL OF FAIRCHILD SEMICONDUCTOR CORPORATION

As used herein:

1. Life support devices or systems are devices or systems which, (a) are intended for surgical implant into the body, or (b) support or sustain life, or (c) whose failure to perform when properly used in accordance with instructions for use

provided in the labeling, can be reasonably expected to result in significant injury to the user.

2. A critical component is any component of a life support device or system whose failure to perform can be reasonably expected to cause the failure of the life support device or system, or to affect its safety or effectiveness.

**PRODUCT STATUS DEFINITIONS**

Definition of terms

Datasheet Identification	Product Status	Definition
Advance Information	Formative or In Design	This datasheet contains the design specifications for product development. Specifications may change in any manner without notice.
Preliminary	First Production	This datasheet contains preliminary data, and supplementary data will be published at a later date. Fairchild Semiconductor reserves the right to make changes at any time without notice in order to improve design.
No Identification Needed	Full Production	This datasheet contains final specifications. Fairchild Semiconductor reserves the right to make changes at any time without notice in order to improve design.
Obsolete	Not In Production	This datasheet contains specifications on a product that has been discontinued by Fairchild Semiconductor. The datasheet is printed for reference information only.

ON Semiconductor and  are trademarks of Semiconductor Components Industries, LLC dba ON Semiconductor or its subsidiaries in the United States and/or other countries. ON Semiconductor owns the rights to a number of patents, trademarks, copyrights, trade secrets, and other intellectual property. A listing of ON Semiconductor's product/patent coverage may be accessed at [www.onsemi.com/site/pdf/Patent-Marking.pdf](http://www.onsemi.com/site/pdf/Patent-Marking.pdf). ON Semiconductor reserves the right to make changes without further notice to any products herein. ON Semiconductor makes no warranty, representation or guarantee regarding the suitability of its products for any particular purpose, nor does ON Semiconductor assume any liability arising out of the application or use of any product or circuit, and specifically disclaims any and all liability, including without limitation special, consequential or incidental damages. Buyer is responsible for its products and applications using ON Semiconductor products, including compliance with all laws, regulations and safety requirements or standards, regardless of any support or applications information provided by ON Semiconductor. "Typical" parameters which may be provided in ON Semiconductor data sheets and/or specifications can and do vary in different applications and actual performance may vary over time. All operating parameters, including "Typicals" must be validated for each customer application by customer's technical experts. ON Semiconductor does not convey any license under its patent rights nor the rights of others. ON Semiconductor products are not designed, intended, or authorized for use as a critical component in life support systems or any FDA Class 3 medical devices or medical devices with a same or similar classification in a foreign jurisdiction or any devices intended for implantation in the human body. Should Buyer purchase or use ON Semiconductor products for any such unintended or unauthorized application, Buyer shall indemnify and hold ON Semiconductor and its officers, employees, subsidiaries, affiliates, and distributors harmless against all claims, costs, damages, and expenses, and reasonable attorney fees arising out of, directly or indirectly, any claim of personal injury or death associated with such unintended or unauthorized use, even if such claim alleges that ON Semiconductor was negligent regarding the design or manufacture of the part. ON Semiconductor is an Equal Opportunity/Affirmative Action Employer. This literature is subject to all applicable copyright laws and is not for resale in any manner.

## PUBLICATION ORDERING INFORMATION

### LITERATURE FULFILLMENT:

Literature Distribution Center for ON Semiconductor  
19521 E. 32nd Pkwy, Aurora, Colorado 80011 USA  
**Phone:** 303-675-2175 or 800-344-3860 Toll Free USA/Canada  
**Fax:** 303-675-2176 or 800-344-3867 Toll Free USA/Canada  
**Email:** [orderlit@onsemi.com](mailto:orderlit@onsemi.com)

**N. American Technical Support:** 800-282-9855 Toll Free  
USA/Canada  
**Europe, Middle East and Africa Technical Support:**  
Phone: 421 33 790 2910  
**Japan Customer Focus Center**  
Phone: 81-3-5817-1050

**ON Semiconductor Website:** [www.onsemi.com](http://www.onsemi.com)  
**Order Literature:** <http://www.onsemi.com/orderlit>  
For additional information, please contact your local  
Sales Representative