



## Features

- 4:1 wide input voltage range
- High efficiency up to 88.0%
- No-load power loss as low as 0.12W
- 1,500Vdc input to output isolation
- Input under-voltage, output over-current, over-voltage and short-circuit protections
- Operating temperature range: -40 to +85 °C
- Industry standard pin-out
- UL 60950-1 2nd edition recognized

## Part Numbering System

LM	x	x	xxx	P	6W	1	ZP	C
Series Name	No. of Output	Input Range	Output Voltage	Enable Logic	Output Power	Isolation Voltage	Package	Version No.
	B: Dual S: Single	1: 9-36V 3: 18-75V	Example: 050: 5V	P: Positive	6W: 6W	1: 1500Vdc	ZP: ZP package	C: Version No.

## Selection Guide

Part No.	Input Voltage (Vdc)	Output		Efficiency(%) at typical input & full load	Max. Load Capacitance (µF)
		Voltage(Vdc)	Current(mA)		
LMB1050P6W1ZPC	24 (9-36)	±5	±600	83.0	680
LMB1090P6W1ZPC		±9	±333	86.0	220
LMB1120P6W1ZPC		±12	±250	87.0	330
LMB1150P6W1ZPC		±15	±200	88.0	220
LMB1240P6W1ZPC		±24	±125	87.0	100
LMS1033P6W1ZPC		3.3	1500	79.0	1800
LMS1050P6W1ZPC		5	1200	83.0	1000
LMS1090P6W1ZPC		9	667	84.0	1000
LMS1120P6W1ZPC		12	500	87.0	470
LMS1150P6W1ZPC		15	400	88.0	220
LMS1240P6W1ZPC		24	250	87.0	100
LMB3050P6W1ZPC		48 (18-75)	±5	±600	83.0
LMB3120P6W1ZPC	±12		±250	87.0	330
LMB3150P6W1ZPC	±15		±200	88.0	220
LMS3033P6W1ZPC	3.3		1500	80.0	1800
LMS3050P6W1ZPC	5		1200	84.0	1000
LMS3120P6W1ZPC	12		500	87.0	470
LMS3150P6W1ZPC	15		400	88.0	220
LMS3240P6W1ZPC	24		250	87.0	100

## Input Specifications

Parameter	Notes & Conditions	Min	Typical	Max	Unit
Input Current(full load)	24Vdc input series	-	301	309	mA
	48Vdc input series	-	148	154	
Input Current (zero load)	24Vdc input series	-	5	12	
	48Vdc input series	-	4	8	
Reflected Ripple Current		-	20	-	
Surge Voltage (1sec. max.)	24Vdc input series	-0.7	-	50	Vdc
	48Vdc input series	-0.7	-	100	
Starting Voltage	24Vdc input series	-	-	9	
	48Vdc input series	-	-	18	
Input Under-voltage protection	24Vdc input series	5.5	6.5	-	
	48Vdc input series	12	15.5	-	
Hot Plugging	Not supported				

## Output Specifications

Parameter	Notes & Conditions	Min	Typical	Max	Unit	
Output Voltage Accuracy*	+Vout	-	±1	±3	%Vo	
	-Vout					
Balance of Output Voltage	Dual output, balanced load	-	±0.5	±1.5		
Line Regulation	Full range input voltage, full load	+Vout	-	±0.2		±0.5
		-Vout	-	±0.5		±1
Load Regulation	5%-100% of full load, nominal input	+Vout	-	±0.5		±1
		-Vout	-	±0.5		±1.5
Cross Regulation	Dual output, main circuit with 50% load, auxiliary circuit with 10%-100% of full load	-	-	±5		
Temperature Coefficient	Full load	-	-	0.03		%/°C
Transient Recovery Time		-	300	500		µs
Transient Response Deviation	25% load step, nominal input voltage	3.3V/5V/±5V output	-	±5	±8	
		Others		±3	±5	
Ripple & Noise	20MHz bandwidth	-	-	85	mVp-p	
Ripple Frequency**		-	300	-	kHz	
Over-voltage Protection	Full input range	110	-	160	%Vo	
Over-current Protection		110	140	190	%Io	
Short circuit Protection		Hiccup mode, continuous, auto recovery				

\*Output voltage accuracy of ±5Vdc/±9Vdc output converters for 0%-5% load is ±5% max.

\*\* The ripple frequency decreases as the load decreases at 50% or less of the full load.

## Safety and Environmental Specifications

Parameter	Notes & Conditions	Min	Typical	Max	Unit
Isolation Voltage	Input-Output, 1 minute, leakage current less than 1mA	1,500	-	-	Vdc
Insulation Resistance	Input-Output, isolation voltage 500Vdc	1,000	-	-	MΩ
Isolation Capacitance	Input-Output, 100KHz/0.1V	-	1,000	-	pF
Operating Temperature		-40	-	+85	°C
Storage Temperature		-55	-	+125	
Storage Humidity	Non-condensing	5	-	95	%RH
Vibration		10-55Hz, 2G, 30 min. along X, Y and Z			
MTBF	MIL-HDBK-217F@25°C	1	-	-	10 <sup>6</sup> hours

Note: Unless otherwise specified, data in this datasheet should be tested under the conditions of nominal input voltage, rated load and Ta=25°C.

## Other Specifications

Parameter	Notes
Case Material	Aluminum alloy
Dimensions	32.00 x 20.00 x 10.80 mm
Weight	12g (Typ.)
Cooling Method	Free air convection

## EMC Specifications

Parameter	Notes & Conditions		
EMI	CE	CISPR32/EN55032 CLASS A (Without extra components) / CLASS B (See Figure 6-2)	
	RE	CISPR32/EN55032 CLASS A (Without extra components) / CLASS B (See Figure 6-2)	
EMS	ESD	IEC/EN61000-4-2 Contact ±4KV	perf. Criteria B
	RS	IEC/EN61000-4-3 10V/m	perf. Criteria A
	EFT	IEC/EN61000-4-4 ±2KV (See Figure 6-1)	perf. Criteria B
	Surge	IEC/EN61000-4-5 ±2KV (See Figure 6-1)	perf. Criteria B
	CS	IEC/EN61000-4-6 3Vrms	perf. Criteria A
	Immunities of voltage dip, drop	IEC/EN61000-4-29 0%, 70%	perf. Criteria B

### Characteristic Curves

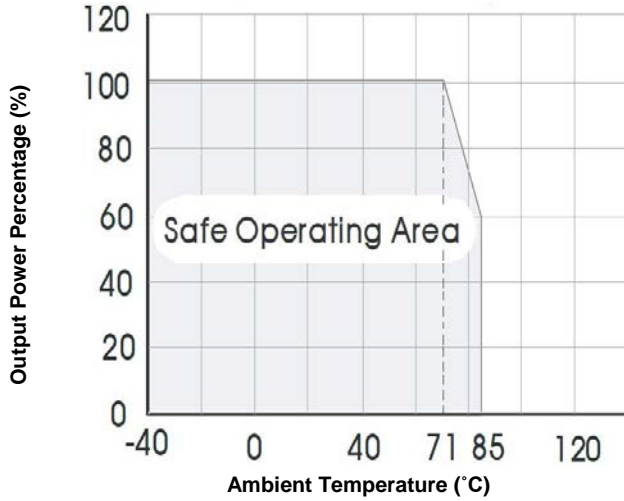

Figure 1. Temperature Derating Curve

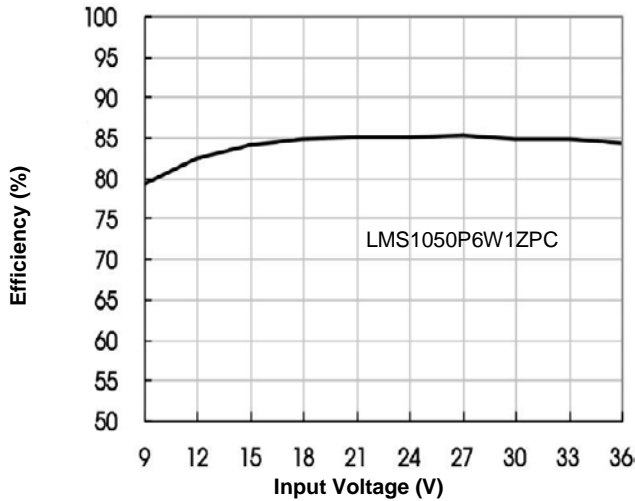

Figure 2. Efficiency vs. Input Voltage (full load)

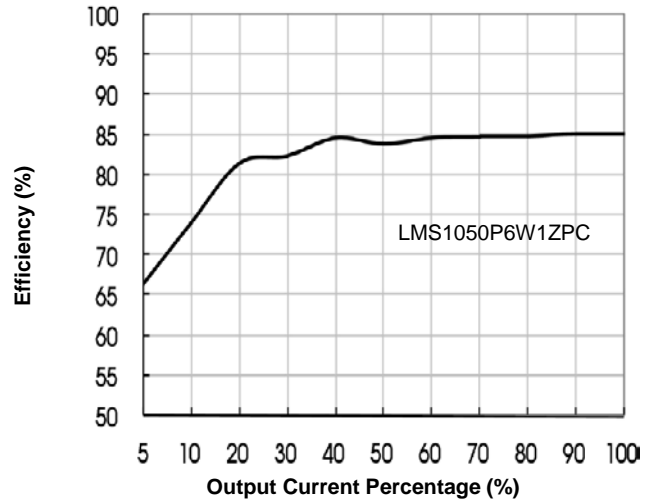

Figure 3. Efficiency vs. Output Load (Vin=24V)

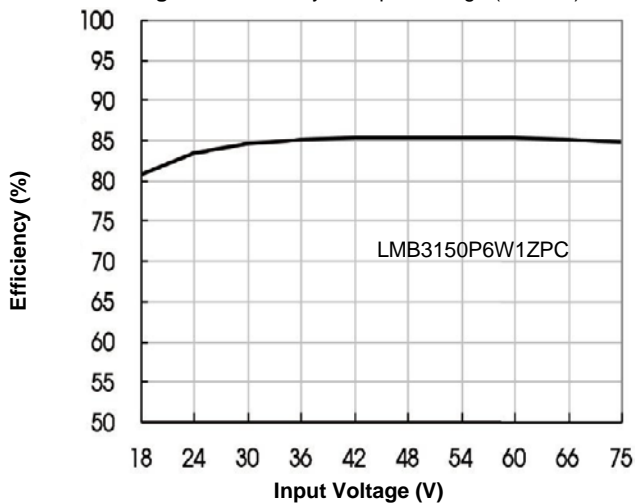

Figure 4. Efficiency vs. Input Voltage (full load)

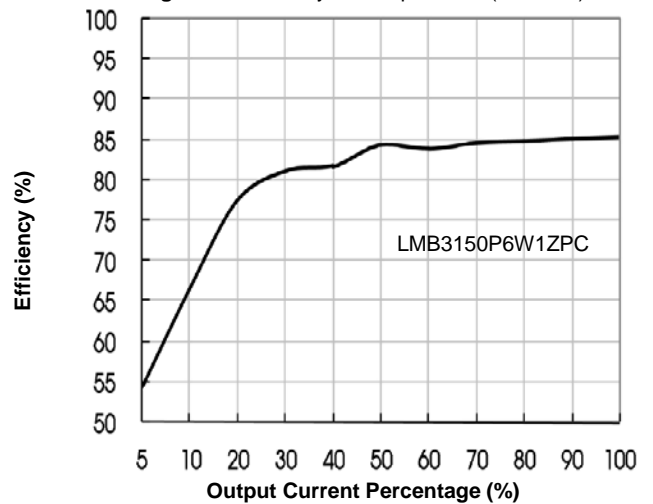
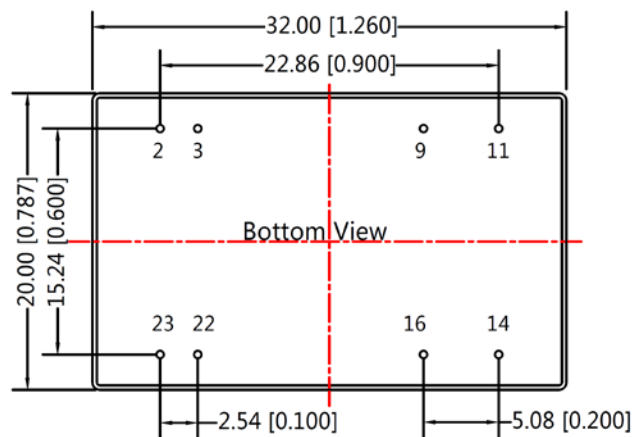
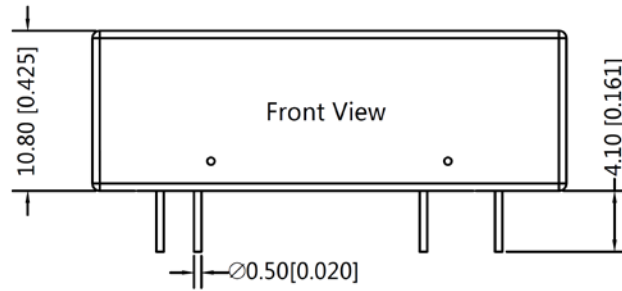

Figure 5. Efficiency vs. Output Load (Vin=48V)

## Mechanical Drawing



Single output		
Pin	Name	Function
2,3	Vin(-)	Negative input voltage
9	Omit	No pin
11	NC	No connection
14	Vout(+)	Positive output voltage
16	Vout(-)	Negative output voltage
22,23	Vin(+)	Positive input voltage
Dual output		
Pin	Name	Function
2,3	Vin(-)	Negative input voltage
9	COM	Output common GND
11	-Vout	Negative output voltage
14	+Vout	Positive output voltage
16	COM	Output common GND
22,23	Vin(+)	Positive input voltage

### Notes:

- 1) All dimension in mm(inches)  
Tolerances:  $\pm 0.50(\pm 0.020)$
- 2) Pin section tolerances :  $\pm 0.10(\pm 0.004)$

## EMC Typical Application Circuit

Single output:

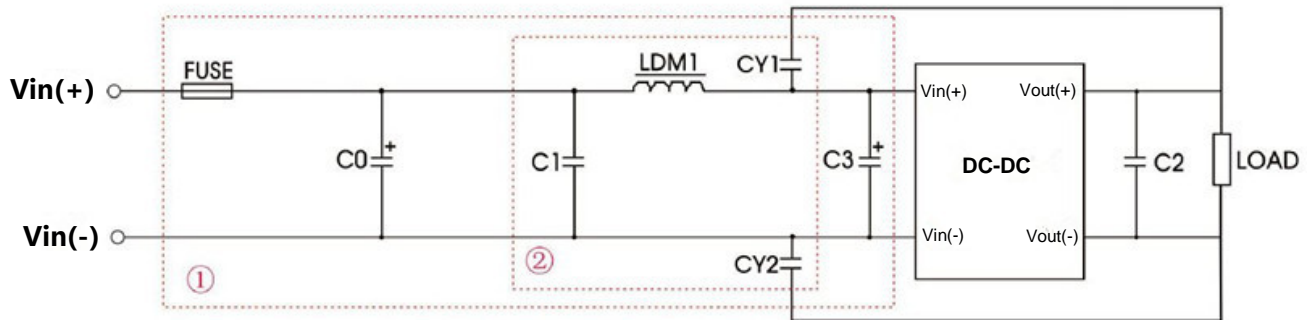

Dual output:

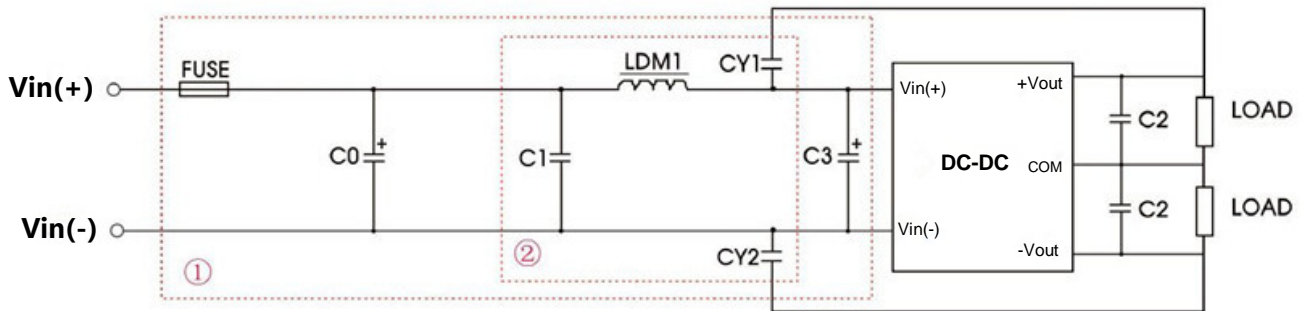

Figure 6. EMC Recommended Circuit

Component	Recommended Value	
	24Vin	48Vin
FUSE	Choose according to the actual input current	
C0, C3	330 $\mu$ F/50V	330 $\mu$ F/100V
C1	1 $\mu$ F/50V	1 $\mu$ F/100V
C2	10 $\mu$ F	
LDM1	4.7 $\mu$ H	
CY1, CY2	1nF/2KV	