

KCLP0403CRSM - Wide Beam - NEMA 5

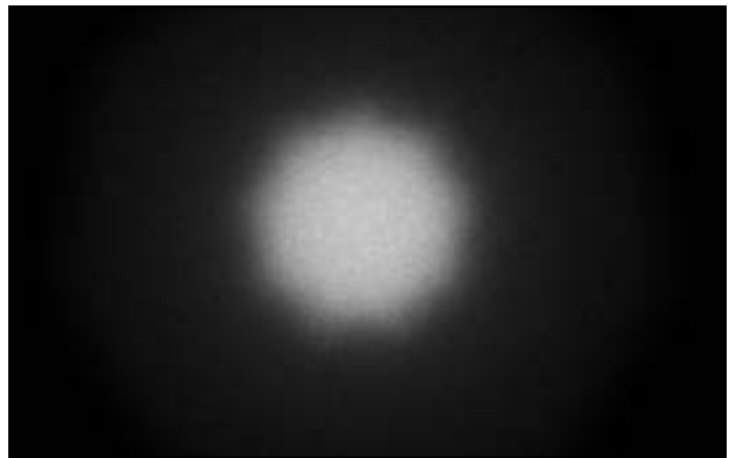

- Material = PC HT Black + Aluminium Reflective Coating (UL94 V0 on Request)
- Efficiency: over 85%
- Full angle at 50% from maximum: ~ 40°
- Full angle at 10% from maximum: ~ 88°
- The light spots here represented refer to tests carried out with LEDs with 3mm Dome and 2mm² LES, ~260lm@LED

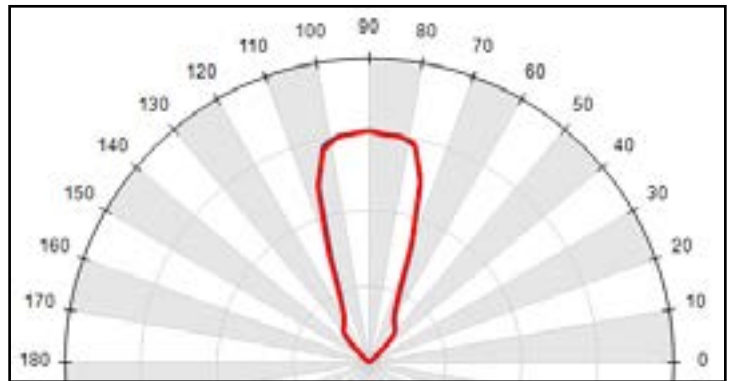
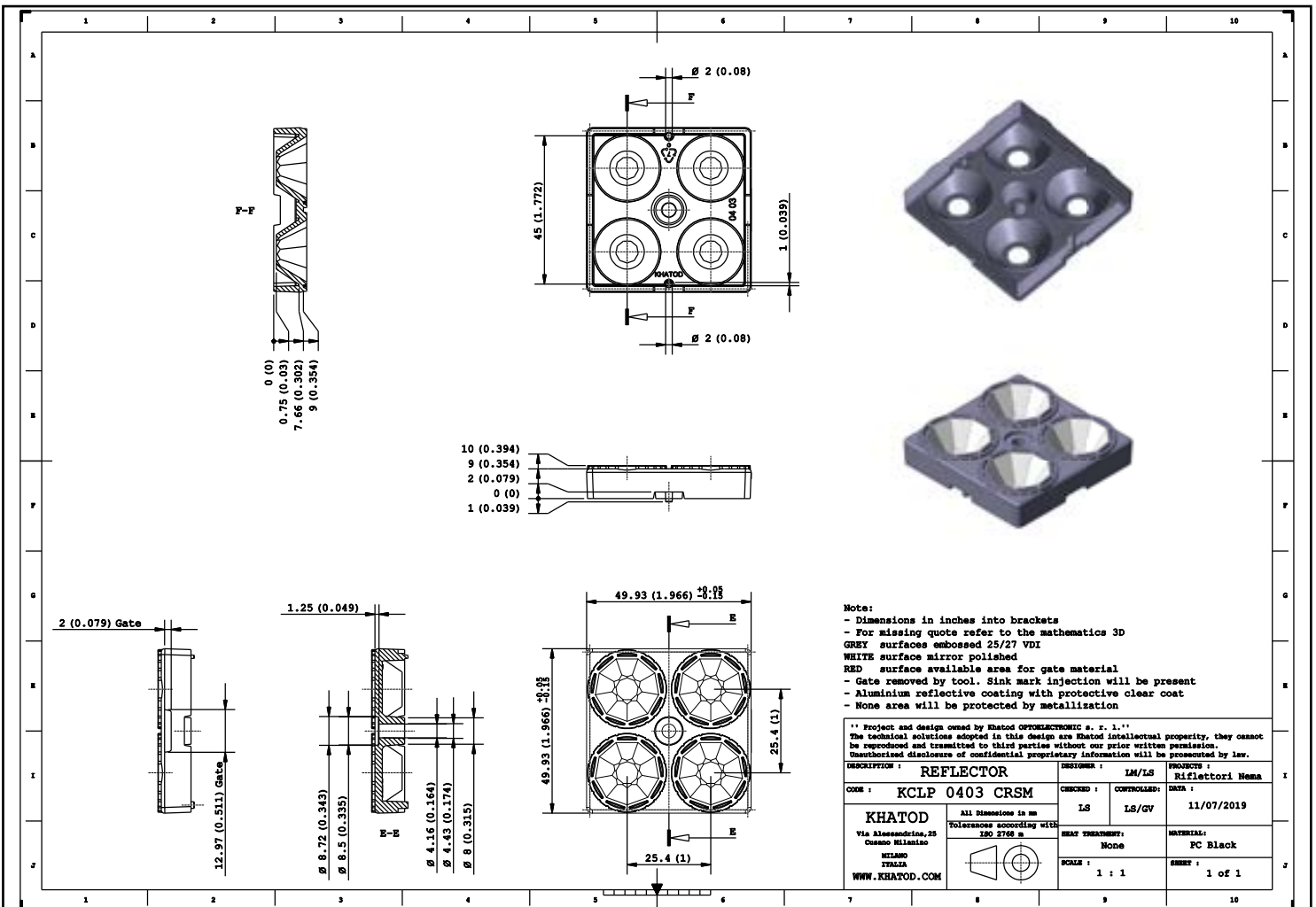

Assembly Specifications

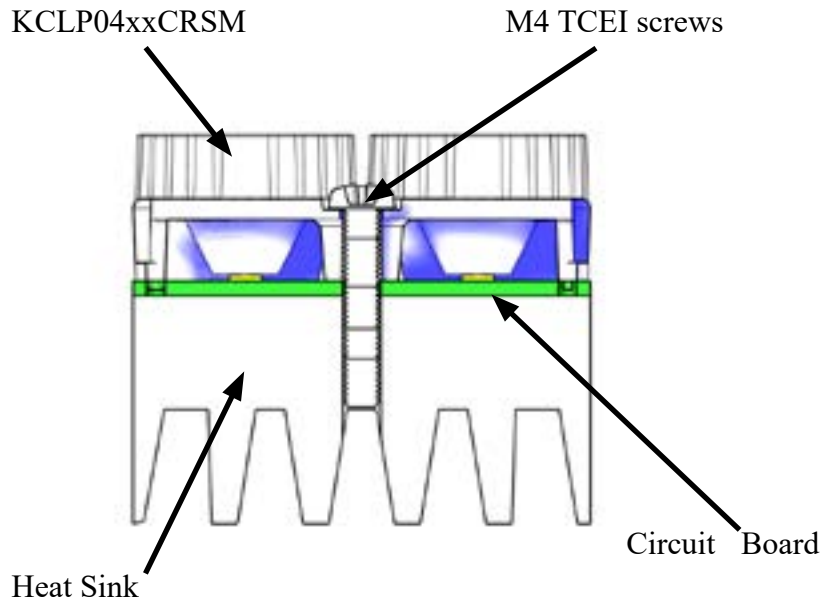

Use M4 TCEI screws

- M4: Maximum tightening torque ~ 0.8/1.2 Nm

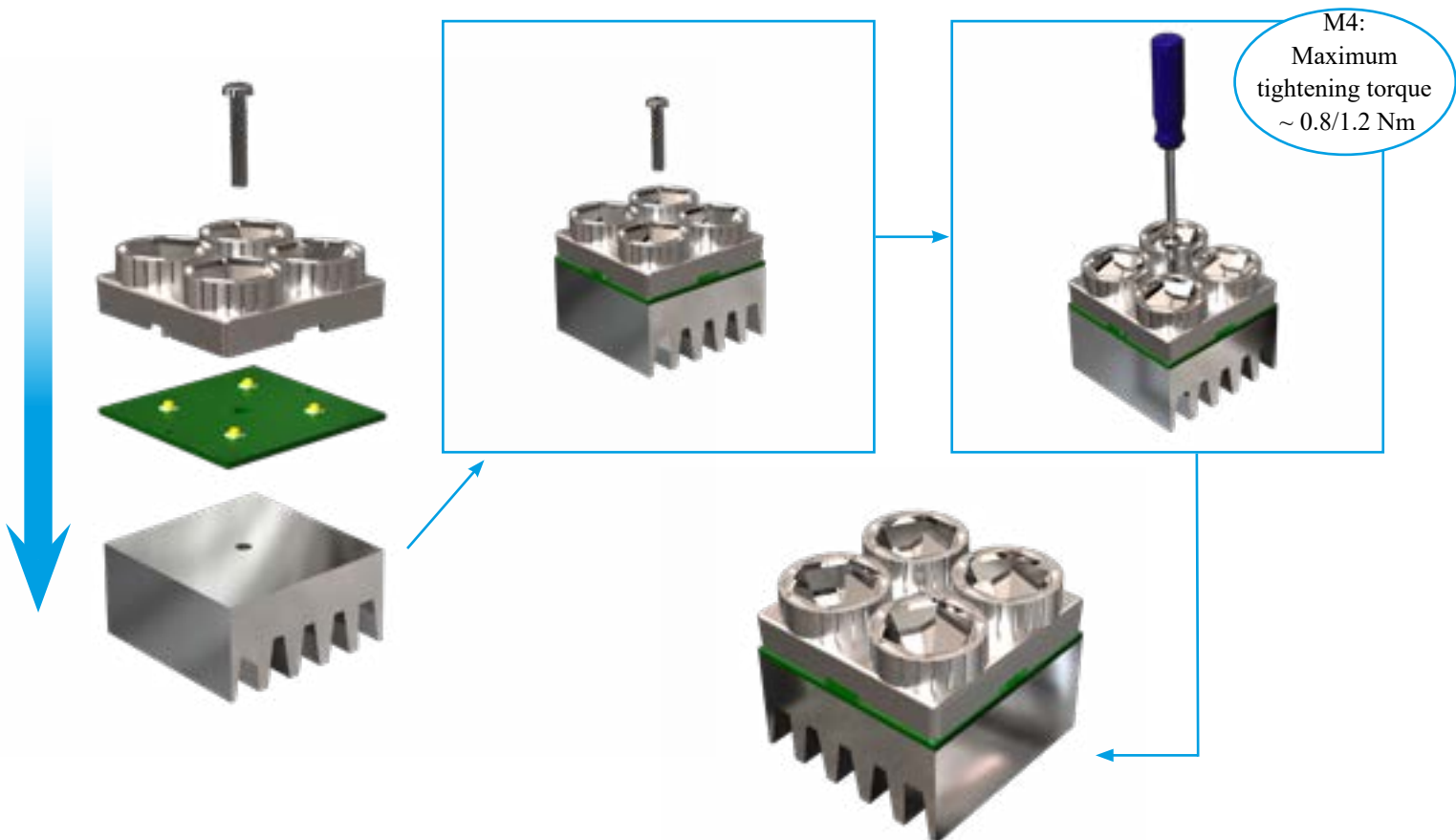

Determination of thermal shock resistance degree

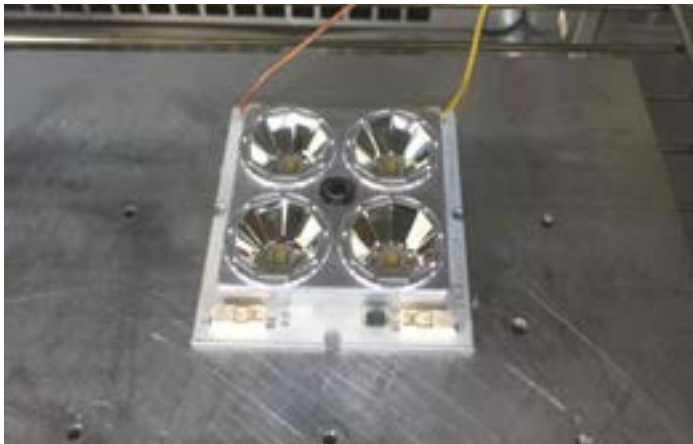

Initial Visual Inspection

Before starting with testing, a visual inspection was performed in order to check the integrity of the part under test.

The part resulted physically intact.

The reference temperature of the component under test is 60° C, and the test was performed with the PCB turned on. Reference PCB: 4 LEDs Samsung LH351B, current driven 700mA.

Photo: the part in the climatic chamber.



Temperature set in the climatic chamber

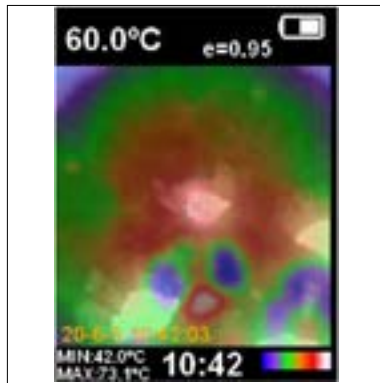

Temperature detected on the part by IR thermal camera

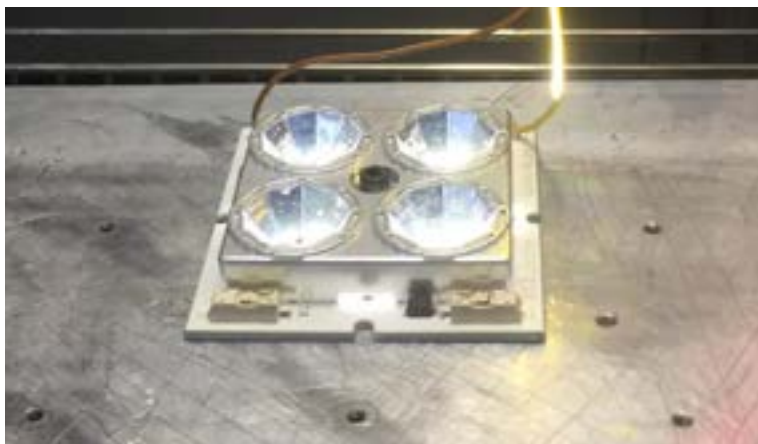

Final Visual Inspection

After testing, a final visual inspection was performed. The result was positive. (view photo)

Photo: the part in the climatic chamber after testing.

Based on the testing result, KCLP04xxCRSM test specimens proved to overcome the thermal stress test up to 60°C, without any physical deterioration of the material.

Packaging

KCLP0402CRSM

Item	Quantity	Total Parts	Size (L*W*H)	G.W.
skin-packed Cardboard	30 pcs per skin-packed Cardboard	30 pcs	--	--
Outer Box	13 skin-packed Cardboards per Outer Box	390 pcs	50*39*33 cm	2.7 Kg

KCLP0403CRSM

Item	Quantity	Total Parts	Size (L*W*H)	G.W.
skin-packed Cardboard	30 pcs per skin-packed Cardboard	30 pcs	--	--
Outer Box	24 skin-packed Cardboards per Outer Box	720 pcs	50*39*33 cm	3.5 Kg

KCLP0404CRSM

Item	Quantity	Total Parts	Size (L*W*H)	G.W.
skin-packed Cardboard	30 pcs per skin-packed Cardboard	30 pcs	--	--
Outer Box	16 skin-packed Cardboards per Outer Box	480 pcs	50*39*33 cm	2.8 Kg

KCLP0405CRSM

Item	Quantity	Total Parts	Size (L*W*H)	G.W.
skin-packed Cardboard	30 pcs per skin-packed Cardboard	30 pcs	--	--
Outer Box	22 skin-packed Cardboards per Outer Box	660 pcs	50*39*33 cm	3.6 Kg

KCLP0406CRSM

Item	Quantity	Total Parts	Size (L*W*H)	G.W.
skin-packed Cardboard	30 pcs per skin-packed Cardboard	30 pcs	--	--
Outer Box	33 skin-packed Cardboards per Outer Box	990 pcs	50*39*33 cm	4.3 Kg

Materials

Material	Top
PC HT	-30°...150°C
KCLP04xxCRSM Temperature resistance: long-term	-30°...105°C
KCLP04xxCRSM Temperature resistance: short exposure	up to + 120 °C

Notes:

- The optical values shown are the result of optical simulations carried out with LIGHTTOOLS, ASAP and ZEMAX software systems. The optical simulations are carried out on the basis of the typical values provided in the LED manufacturers' official datasheets. The photometric analysis has been carried out on physical samples.

Use and Maintenance

- DO NOT HANDLE OR INSTALL LENSES WITHOUT WEARING GLOVES, SKIN OILS MAY DAMAGE LENS OR LIGHT TRANSMISSION;
- CLEAN LENSES WITH MILD SOAP AND WATER AND A SOFT CLOTH;
- DO NOT USE ANY COMMERCIAL CLEANING SOLVENTS ON LENSES.

Disclaimer

Please note that flow lines and weld lines on the external surfaces of the lenses are acceptable if the optical performance of the lens is within the specifications.

Should you require further information, please contact Khatod for advice. All lens testing must be subject to identical conditions as Khatod test condition. Khatod Optoelectronic, Milan, Italy, manufactures lenses for LEDs. Any other use of the lens shall void our liability and warranty. The lenses are an inert component to be used in the manufacture of various products. Our warranty and liability are limited only to the manufacture of the lens. You may not modify, copy, distribute reproduce, license or alter the lens and related materials of Khatod. Khatod does not warrant against damages or defects arising out of the use or misuse of the products; against defects or damage arising from improper installation, or against defects in the product or in its components. No warranty of any kind, expressed or implied, is made regarding the safety of the products. The entire risk as to the quality or performance of the product is with the buyer. In no event shall Khatod be liable for any direct, indirect, punitive, incidental, special, consequential damages, or any damages whatsoever arising out of or connected with the use or misuse of the product. Khatod shall not have any obligation with respect to the product or any part thereof, whether based on contract, tort, strict liability or otherwise. Buyer assumes all risks and liability from use of the product. The laws of Milan, Italy govern this product warranty and liability and you hereby consent to the exclusive jurisdiction and venue of courts in Milan, Italy in all disputes arising out of or relating to the use of this product. Production, marketing, distribution, sale of these products as well as their possible modifications and variations are only exclusive right of Khatod Optoelectronic. No company can perform any of these actions without written permission released by Khatod Optoelectronic. The information contained in this document is proprietary of Khatod Optoelectronic and may change without notice.

REPRODUCTION PROHIBITED.