



P-DUKE POWER

MAH450 Series

3 X 5 Inch AC-DC POWER SUPPLIES
Up to 450 Watts

5
YEARS
WARRANTY

ROHS
COMPLIANT

REACH
COMPLIANT

+85°C
-40°C
AMBIENT TEMP.



Medical



Automation



Datacom



IPC



Industry



Measurement



Telecom



Automobile



Boat



Charger



PV



Railway

UL US CB CE UK CA



2 x MOPP	4000 VAC Reinforced Insulation	ADJ. Output Voltage	Internal EN55032 Class Filter B	LOW Leakage Current	LOW Standby Power	Operating Altitude 5000 meter	POWER GOOD	Protection Class I Class II	REMOTE ON OFF	OCP	OTP
OVP	SCP										

PART NUMBER STRUCTURE

M	A	H	450	U	S	12	<input type="checkbox"/>	-	F2
Application	Package Code	Dimension Code	Output Power (W)	Input Voltage (VAC)	Output Quantity	Output Voltage (VDC)	Protection Type		Options
Medical Application	A: Open type E: Enclosed type			U: Universal 85 ~ 264VAC	S: Single	12: 12V 15: 15V 24: 24V 28: 28V 36: 36V 48: 48V 53: 53V	<input type="checkbox"/> : CLASS I <input checked="" type="checkbox"/> : CLASS II		<input type="checkbox"/> : Fan connector with fixed fan speed control. <input checked="" type="checkbox"/> : Fan connector with variable fan speed control. For MEH450 only: Fixed fan speed F1 : Fan 1, fan on the top F2 : Fan 2, fan on the side Variable fan speed Y1 : Fan 1, fan on the top Y2 : Fan 2, fan on the side

TECHNICAL SPECIFICATION All specifications are typical at 230VAC input, full load and 25°C unless otherwise noted

Model Number	Input Range	Output Voltage	Output Current @ 230VAC				Input Power @No Load	Efficiency	Maximum Capacitor Load
			Natural Convection	Conduction Cooling	Forced Air Cooling				
					21 CFM External Fan	Internal Fan			
VAC	VDC	A	A	A	A	W	%	µF	
MAH450US12(-Y)	85 ~ 264	12	20.8	23.3	37.5	---	0.3	91	31250
MEH450US12(-Y)	85 ~ 264	12	20.8	23.3	37.5	---	0.3	91	31250
MEH450US12-F1(Y1)	85 ~ 264	12	---	---	---	37.5	0.4	91	31250
MEH450US12-F2(Y2)	85 ~ 264	12	---	---	---	37.5	0.4	91	31250
MAH450US15(-Y)	85 ~ 264	15	16.6	18.6	30.0	---	0.5	92	20000
MEH450US15(-Y)	85 ~ 264	15	16.6	18.6	30.0	---	0.5	92	20000
MEH450US15-F1(Y1)	85 ~ 264	15	---	---	---	30.0	0.8	92	20000
MEH450US15-F2(Y2)	85 ~ 264	15	---	---	---	30.0	0.8	92	20000
MAH450US24(-Y)	85 ~ 264	24	13.3	14.55	18.75	---	0.5	93	7820
MEH450US24(-Y)	85 ~ 264	24	13.3	14.55	18.75	---	0.5	93	7820
MEH450US24-F1(Y1)	85 ~ 264	24	---	---	---	18.75	0.8	93	7820
MEH450US24-F2(Y2)	85 ~ 264	24	---	---	---	18.75	0.8	93	7820
MAH450US28(-Y)	85 ~ 264	28	11.4	12.5	16.1	---	0.5	93	5750
MEH450US28(-Y)	85 ~ 264	28	11.4	12.5	16.1	---	0.5	93	5750
MEH450US28-F1(Y1)	85 ~ 264	28	---	---	---	16.1	0.8	93	5750
MEH450US28-F2(Y2)	85 ~ 264	28	---	---	---	16.1	0.8	93	5750
MAH450US36(-Y)	85 ~ 264	36	8.9	9.72	12.5	---	0.5	93	3500
MEH450US36(-Y)	85 ~ 264	36	8.9	9.72	12.5	---	0.5	93	3500
MEH450US36-F1(Y1)	85 ~ 264	36	---	---	---	12.5	0.8	93	3500
MEH450US36-F2(Y2)	85 ~ 264	36	---	---	---	12.5	0.8	93	3500
MAH450US48(-Y)	85 ~ 264	48	6.65	7.3	9.4	---	0.5	94	1960
MEH450US48(-Y)	85 ~ 264	48	6.65	7.3	9.4	---	0.5	94	1960
MEH450US48-F1(Y1)	85 ~ 264	48	---	---	---	9.4	0.8	94	1960
MEH450US48-F2(Y2)	85 ~ 264	48	---	---	---	9.4	0.8	94	1960
MAH450US53(-Y)	85 ~ 264	53	6.05	6.6	8.55	---	0.5	94	1600
MEH450US53(-Y)	85 ~ 264	53	6.05	6.6	8.55	---	0.5	94	1600
MEH450US53-F1(Y1)	85 ~ 264	53	---	---	---	8.55	0.8	94	1600
MEH450US53-F2(Y2)	85 ~ 264	53	---	---	---	8.55	0.8	94	1600

INPUT SPECIFICATIONS						
Parameter	Conditions			Min.	Typ.	Max. Unit
Operating input voltage range	AC input			85		264 VAC
	DC input			120		370 VDC
Input frequency	AC input			47		63 Hz
Input current	100VAC and Full Load					5.8 A
	240VAC and Full Load					2.4 A
No load input power	230VAC	MAH(-Y), MEH(-Y)	12Vout others		0.3	Watts
		MEH -F□(Y□)	12Vout others		0.5	
Leakage current	264VAC					100 µA
Power Factor				0.95		
Start up time						2000 ms
Rise time					30	ms
Hold up time	115VAC and Full Load				14	ms
Input inrush current	230VAC					100 A
Input protection	Internal fuse in line and neutral			T6.3A/250VAC		
Main output remote control	Positive Logic Referenced to "-Control"		Main power ON	Open or 3 ~ 12 VDC		
	*Standby power always present		Main power OFF	Short or 0 ~ 1.2VDC		
			Input current of Control	-0.5		1 mA

OUTPUT SPECIFICATIONS

Parameter	Conditions		Min.	Typ.	Max.	Unit
Output power	Forced air cooling	All			450	Watts
	Conduction cooling @ 230VAC	12Vout, 15Vout			280	
		others			350	
	Natural convection @ 230VAC	12Vout, 15Vout			250	
		others			320	
	* Please refer to the derating curve for detailed rating.					
Initial set voltage accuracy	230VAC and Full Load		-1.0		+1.0	%
Line regulation	Low Line to High Line at Full Load		-0.2		+0.2	%
Load regulation	No Load to Full Load		-0.5		+0.5	%
	10% Load to 90% Load		-0.4		+0.4	
Voltage adjustability	Maximum output deviation is inclusive of remote sense		-8		+8	%
Minimum load				0		%
Ripple and noise	Measured by 20MHz bandwidth					mVp-p
	With a 1 μ F/25V 1206 X7R MLCC	12Vout			250	
		15Vout			300	
	With a 1 μ F/50V 1206 X7R MLCC	24Vout			240	
		28Vout			280	
36Vout				360		
With a 0.1 μ F/100V 1206 X7R MLCC	48Vout			480		
	53Vout			530		
Temperature coefficient			-0.02		+0.02	%/°C
Transient response	Load step from 50 ~ 75% change at 2.5A/ μ s	Peak deviation		3		% Vout
		Recovery time		600		μ s
Over voltage protection	% of Vout(nom); Latch mode		110		135	%
Over load protection	% of maximum lout rated; Hiccup mode		115		155	%
Short circuit protection	Protection level 1 (nominal) Protection level 2 (instantaneous high current)		Continuous, automatic recovery			Latch
Standby power supply	Always present when AC supplied					5V / 200mA
Fan power supply	Fixed fan speed function					12V / 500mA
Main output Power Good signal	Referenced to "GND"		Power good		Low	
			Power off		Open collector	

GENERAL SPECIFICATIONS

Parameter	Conditions		Min.	Typ.	Max.	Unit
Isolation voltage	1 minute (2MOPP insulation)	Input to Output Input (Output) to F.G.	4000 2500			VAC
Isolation resistance	500VDC		0.1			G Ω
Switching frequency	230VAC, Full load		15Vout		75	kHz
			Other		65	
Safety approvals	IEC/ EN/ ANSI/AAMI ES 60601-1 IEC/ EN/ UL 62368-1				UL:E360199 UL:E193009 CB:UL(Demko)	
Weight			MAH(-Y)		462g(16.29oz)	
			MEH(-Y)		504g(17.77oz)	
			MEH -F1(Y1)		524g(18.48oz)	
			MEH -F2(Y2)		552g(19.47oz)	
MTBF	MIL-HDBK-217F Ta=25°C, Full load				4.093 x 10 ⁵ hrs	

ENVIRONMENTAL SPECIFICATIONS

Parameter	Conditions		Min.	Typ.	Max.	Unit
Operating ambient temperature	With derating	MAH(-Y), MEH(-Y)	-40		+85	°C
		MEH -F□(Y□)	-40		+80	
Storage temperature range			MAH, MEH		+85	°C
			MEH -F□(Y□)		+80	
Over temperature protection	Internal thermistor ; Latch mode		110		125	°C
Operating altitude	With derating				5000	m
Shock					IEC60068-2-27	
Vibration					IEC60068-2-6	
Relative humidity	Non-condensing				5% to 95% RH	

EMC SPECIFICATIONS

Parameter	Conditions	Level
EMI	EN55011, EN55032, EN60601-1-2 and FCC Part 18 / 15 For optimum EMI performance, the power supply should be mounted to a metal plate grounded to all 4 mounting holes of the power supply. To comply with safety standards, this plate must be properly grounded to protective earth.	Conducted Class B Radiated Class A
Harmonic currents	EN61000-3-2 Full Load	Class A and D
Voltage flicker	EN61000-3-3	
EMS	EN55035 and EN60601-1-2	
ESD	EN61000-4-2	Perf. Criteria A
Radiated immunity	EN61000-4-3 3 V/m	Perf. Criteria A
Fast transient	EN61000-4-4 ± 2 kV	Perf. Criteria A
Surge	EN61000-4-5 DM ± 1 kV and CM ± 2 kV	Perf. Criteria A
Conducted immunity	EN61000-4-6 20 Vr.m.s	Perf. Criteria A
Power frequency magnetic field	EN61000-4-8 30 A/m	Perf. Criteria A
Dip and interruptions	EN61000-4-11	

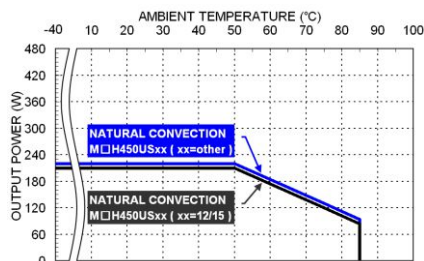
CHARACTERISTIC CURVE

Derating Curve vs. Ambient Temperature
Vin=115VAC and Natural convection

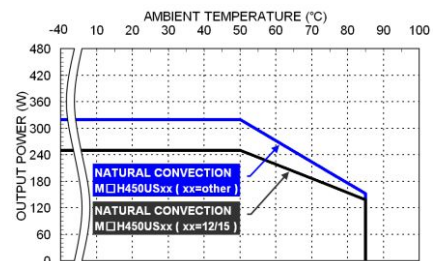

Derating Curve vs. Ambient Temperature
Vin=230VAC and Natural convection

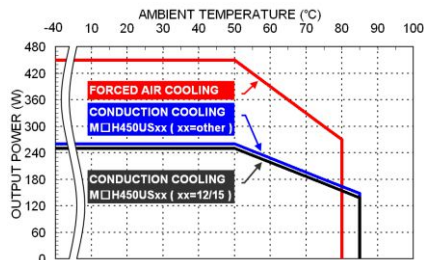

Derating Curve vs. Ambient Temperature
Vin=115VAC and Conduction cooling tested by 43x24.8x0.12cm plate
Forced air cooling with 21CFM (External Fan)

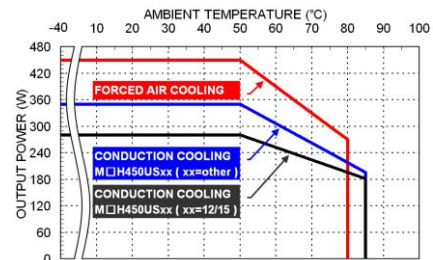

Derating Curve vs. Ambient Temperature
Vin=230VAC and Conduction cooling tested by 43x24.8x0.12cm plate
Forced air cooling with 21CFM (External Fan)

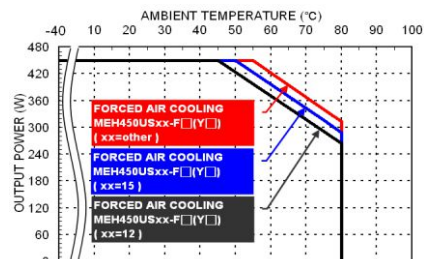

Derating Curve vs. Ambient Temperature
Vin=115VAC and Forced air cooling (Internal Fan)

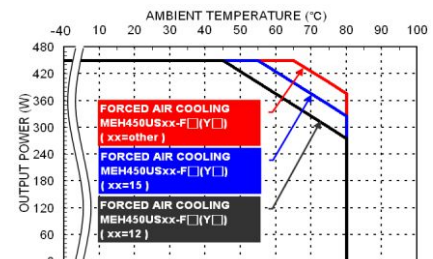

Derating Curve vs. Ambient Temperature
Vin=230VAC and Forced air cooling (Internal Fan)

CHARACTERISTIC CURVE (CONTINUED)

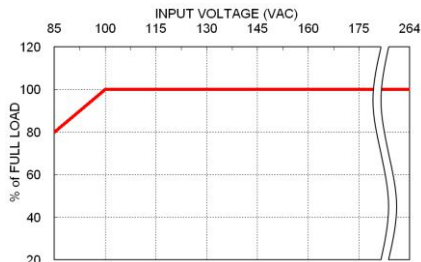

Derating Curve vs. Input Voltage
M□H450

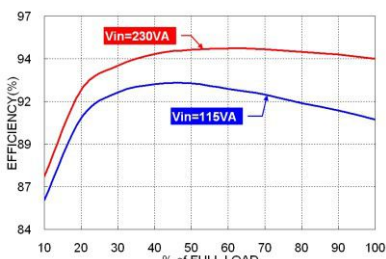

Efficiency vs. Output Load
M□H450US24 with Forced air cooling

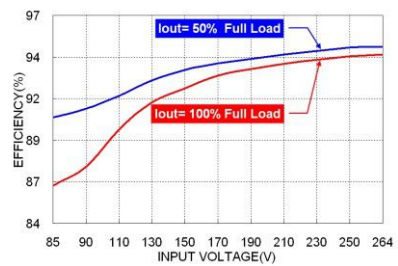

Efficiency vs. Input Voltage
M□H450US24 with Forced air cooling

OUTPUT SENSING

Output sensing function can be applied via connecting wires on CON3. Initially, Pin 7 and Pin 8 are shorted by a jumper set as default, shown as Fig. 1.

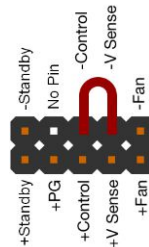
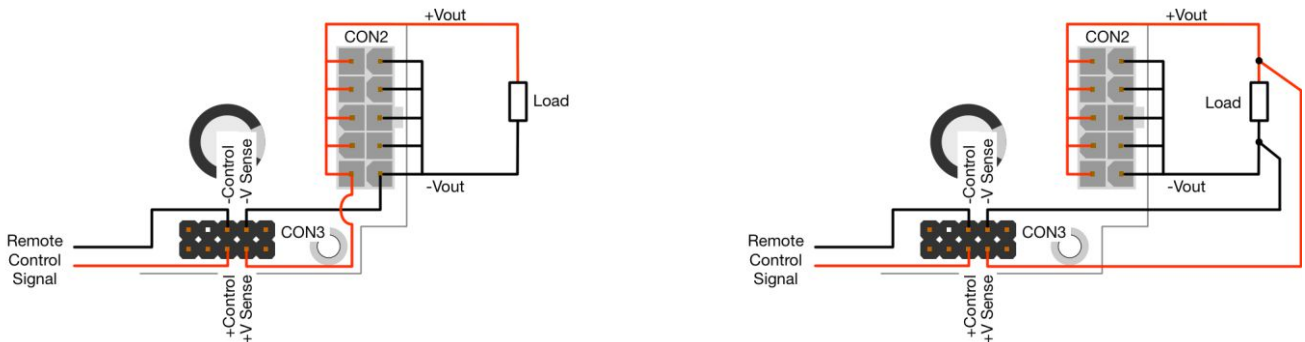

Fig. 1 Default connection

But if remote control function is to be used, the jumper on Pin 7 and Pin 8 should be removed. Since sense pins should not be left open for module stability, please follow the connections as below (Fig. 2).



(a) Sense pins connect to corresponding polarity of Vout pin (b) Sense pins connect to corresponding polarity terminal of load.
Fig. 2 Recommended output sensing connections

MECHANICAL DRAWING

MAH450USXX (-Y)

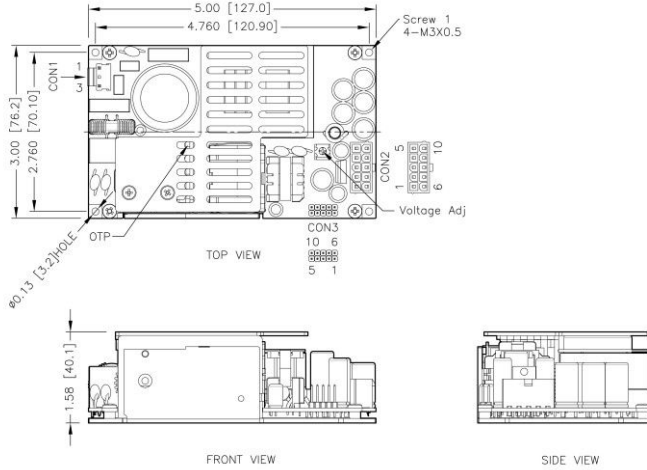

*Either one of four screw holes can be considered as PE connection for CLASS I application.

1. All dimensions in inch [mm]
2. Tolerance : x.xx±0.02 [x.x±0.5]
x.xxx±0.01 [x.xx±0.25]
3. Screw 1 locked torque : MAX 5.2Kgf-cm/0.51N.m

CONNECTORS CONNECTIONS

CON1 – Input Connector

Pin 1	Line
Pin 3	Neutral

Mates with
Molex housing : **09-50-8031**
Molex crimp terminals : **2478,6838,45570**

CON2 – Output Connector

Pin 1,2,3,4,5	+Vout
Pin 6,7,8,9,10	-Vout

Mates with
Molex housing : **39-01-2105**
Molex crimp terminals : **5556,45750**

CON3 – Aux Connector

Pin 1	+Fan	Pin 6	-Fan (GND)
Pin 2	+V Sense	Pin 7	-V Sense
Pin 3	+Control	Pin 8	-Control (GND)
Pin 4	+PG	Pin 9	No Pin
Pin 5	+Standby	Pin10	-Standby (GND)

Mates with
Molex housing : **90143-0008**
Molex crimp terminals : **90119**

MEH450USXX (-Y)

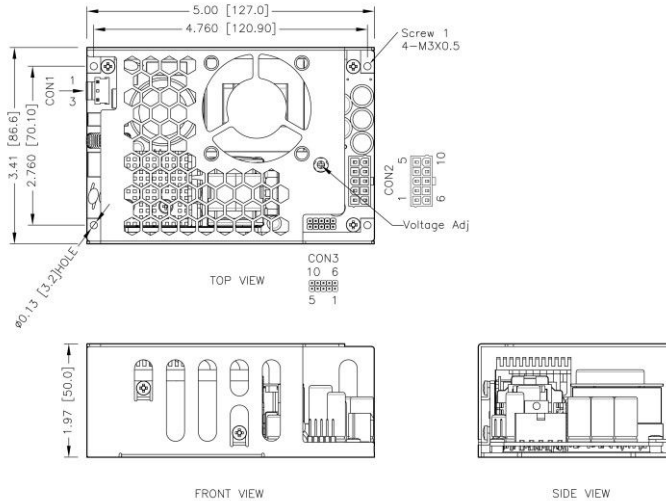

*Either one of four screw holes can be considered as PE connection for CLASS I application.

1. All dimensions in inch [mm]
2. Tolerance : x.xx±0.02 [x.x±0.5]
x.xxx±0.01 [x.xx±0.25]
3. Screw 1 locked torque : MAX 5.2Kgf-cm/0.51N.m

CONNECTORS CONNECTIONS

CON1 – Input Connector

Pin 1	Line
Pin 3	Neutral

Mates with
Molex housing : **09-50-8031**
Molex crimp terminals : **2478,6838,45570**

CON2 – Output Connector

Pin 1,2,3,4,5	+Vout
Pin 6,7,8,9,10	-Vout

Mates with
Molex housing : **39-01-2105**
Molex crimp terminals : **5556,45750**

CON3 – Aux Connector

Pin 1	+Fan	Pin 6	-Fan (GND)
Pin 2	+V Sense	Pin 7	-V Sense
Pin 3	+Control	Pin 8	-Control (GND)
Pin 4	+PG	Pin 9	No Pin
Pin 5	+Standby	Pin10	-Standby (GND)

Mates with
Molex housing : **90143-0008**
Molex crimp terminals : **90119**

MECHANICAL DRAWING (CONTINUED)

MEH450USXX-F1 (Y1) FAN dimension: 50x50x10mm Air flow: 11.4 CFM
 The fan's life is shorter than power supply and has only 2 years warranty.

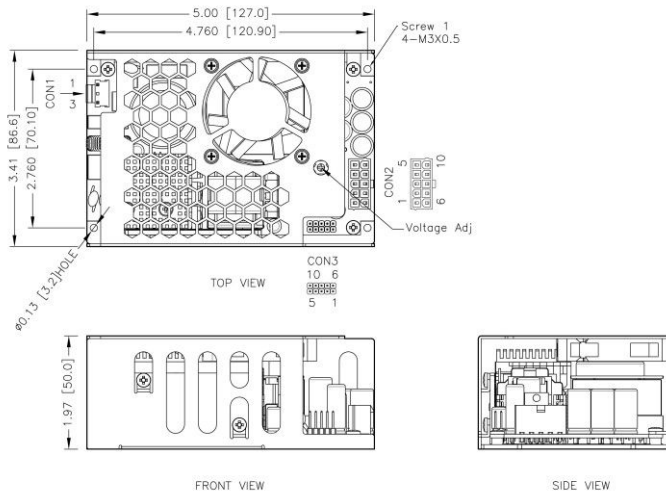

*Either one of four screw holes can be considered as PE connection for CLASS I application.

1. All dimensions in inch [mm]
2. Tolerance : x.xx±0.02 [x.x±0.5]
x.xxx±0.01 [x.xx±0.25]
3. Screw 1 locked torque : MAX 5.2Kgf-cm/0.51N.m

CONNECTORS CONNECTIONS

CON1 – Input Connector

Pin 1	Line
Pin 3	Neutral

Mates with
 Molex housing : **09-50-8031**
 Molex crimp terminals : **2478,6838,45570**

CON2 – Output Connector

Pin 1,2,3,4,5	+Vout
Pin 6,7,8,9,10	-Vout

Mates with
 Molex housing : **39-01-2105**
 Molex crimp terminals : **5556,45750**

CON3 – Aux Connector

Pin 1	+Fan	Pin 6	-Fan (GND)
Pin 2	+V Sense	Pin 7	-V Sense
Pin 3	+Control	Pin 8	-Control (GND)
Pin 4	+PG	Pin 9	No Pin
Pin 5	+Standby	Pin10	-Standby (GND)

Mates with
 Molex housing : **90143-0008**
 Molex crimp terminals : **90119**

MEH450USXX-F2 (Y2) FAN dimension: 40x40x10mm Air flow: 9.5 CFM
 The fan's life is shorter than power supply and has only 2 years warranty.

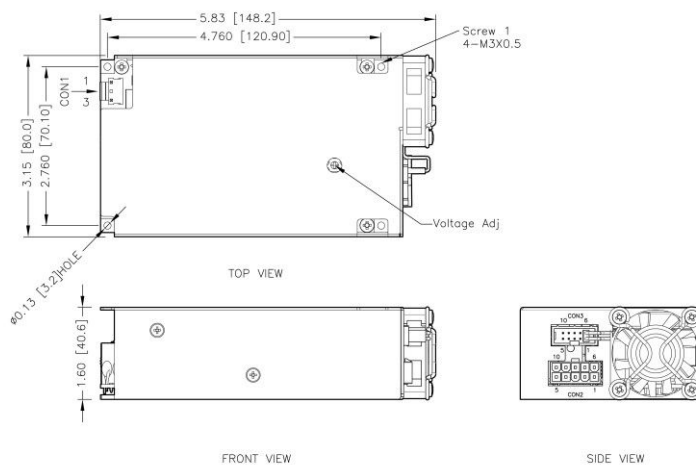

*Either one of four screw holes can be considered as PE connection for CLASS I application.

1. All dimensions in inch [mm]
2. Tolerance : x.xx±0.02 [x.x±0.5]
x.xxx±0.01 [x.xx±0.25]
3. Screw 1 locked torque : MAX 5.2Kgf-cm/0.51N.m

CONNECTORS CONNECTIONS

CON1 – Input Connector

Pin 1	Line
Pin 3	Neutral

Mates with
 Molex housing : **09-50-8031**
 Molex crimp terminals : **2478,6838,45570**

CON2 – Output Connector

Pin 1,2,3,4,5	-Vout
Pin 6,7,8,9,10	+Vout

Mates with
 Molex housing : **39-01-2105**
 Molex crimp terminals : **5556,45750**

CON3 – Aux Connector

Pin 1	+Fan	Pin 6	-Fan (GND)
Pin 2	+V Sense	Pin 7	-V Sense
Pin 3	+Control	Pin 8	-Control (GND)
Pin 4	+PG	Pin 9	No Pin
Pin 5	+Standby	Pin10	-Standby (GND)

Mates with
 Molex housing : **90143-0008**
 Molex crimp terminals : **90119**

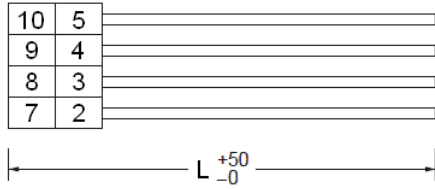
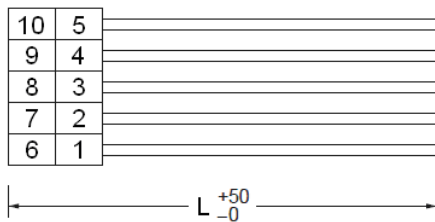
OPTIONAL PARTS
7N-0265-F :

7N-0266-F :

CON3 housing

Pin 2	+V Sense	gray	26AWG
Pin 3	+Control	orange	26AWG
Pin 4	+PG	blue	26AWG
Pin 5	+Standby	red	22AWG
Pin 7	-V Sense	green	26AWG
Pin 8	-Control (GND)	brown	26AWG
Pin 9	No wire	---	---
Pin10	-Standby (GND)	black	22AWG

Length (L) : 500mm typical

CON3 housing

Pin 1	+Fan	yellow	26AWG
Pin 2	+V Sense	gray	26AWG
Pin 3	+Control	orange	26AWG
Pin 4	+PG	blue	26AWG
Pin 5	+Standby	red	22AWG
Pin 6	-Fan (GND)	brown	26AWG
Pin 7	-V Sense	green	26AWG
Pin 8	-Control (GND)	brown	26AWG
Pin 9	No wire	---	---
Pin10	-Standby (GND)	black	22AWG

Length (L) : 500mm typical