

HIGH EFFICIENCY FAST RECOVERY RECTIFIER DIODES

FEATURES

- SUITED FOR SMPS
- VERY LOW FORWARD LOSSES
- NEGLIGIBLE SWITCHING LOSSES
- HIGH SURGE CURRENT CAPABILITY
- HIGH AVALANCHE ENERGY CAPABILITY
- INSULATED :
Insulating voltage = 2500 V_{RMS}
Capacitance = 45 pF

DESCRIPTION

Dual rectifier suited for switchmode power supply and high frequency DC to DC converters. Packaged in ISOTOP™ this device is intended for use in low voltage, high frequency inverters, free wheeling and polarity protection applications.

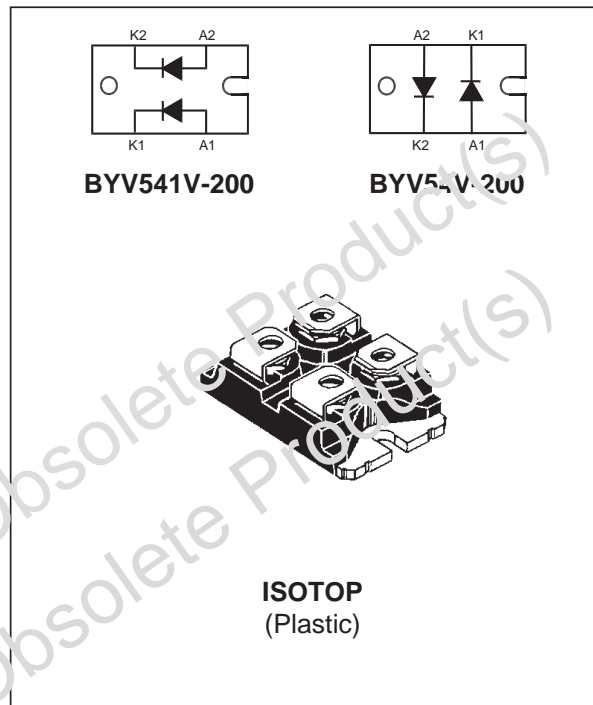

ABSOLUTE MAXIMUM RATINGS

Symbol	Parameter			Value	Unit
$I_{F(RMS)}$	RMS forward current		Per diode	100	A
$I_{F(AV)}$	Average forward current $\delta = 0.5$	$T_c = 90^\circ\text{C}$	Per diode	50	A
I_{FSM}	Surge non repetitive forward current	$t_p = 10\text{ms}$ sinusoidal	Per diode	1000	A
T_{stg} T_J	Storage and junction temperature range			- 40 to + 150 - 40 to + 150	$^\circ\text{C}$ $^\circ\text{C}$

Symbol	Parameter	BYV54V / BYV541V	Unit
V_{RRM}	Repetitive peak reverse voltage	200	V

ISOTOP is a trademark of STMicroelectronics.

BYV54V / BYV541V**THERMAL RESISTANCE**

Symbol	Parameter		Value	Unit
Rth (j-c)	Junction to case	Per diode	1.2	°C/W
		Total	0.85	
Rth (c)	Coupling		0.1	°C/W

When the diodes 1 and 2 are used simultaneously :

$$T_j - T_c (\text{diode 1}) = P(\text{diode 1}) \times R_{th(j-c)}(\text{Per diode}) + P(\text{diode 2}) \times R_{th(c)}$$

**ELECTRICAL CHARACTERISTICS (Per diode)
STATIC CHARACTERISTICS**

Symbol	Test Conditions		Min.	Typ.	Max.	Unit
I _R *	T _j = 25°C	V _R = V _{RRM}			50	μA
	T _j = 100°C				5	mA
V _F **	T _j = 125°C	I _F = 50 A			0.85	V
	T _j = 125°C	I _F = 100 A			1.00	
	T _j = 25°C	I _F = 100 A			1.15	

Pulse test :

* t_p = 5 ms, duty cycle < 2 %

** t_p = 380 μs, duty cycle < 2 %

RECOVERY CHARACTERISTICS

Symbol	Test Conditions			Min.	Typ.	Max.	Unit
trr	T _j = 25°C	I _F = 0.5A I _R = 1A	I _{rr} = 0.25A			40	ns
		I _F = 1A V _R = 30V	dI _F /dt = -50A/μs			60	
tfr	T _j = 25°C	I _F = 1A V _{FR} = 1.1 x V _F	tr = 5 ns		10		ns
V _{FP}	T _j = 25°C	I _F = 1A	tr = 5 ns		1.5		V

Fig.1 : Average forward power dissipation versus average forward current.

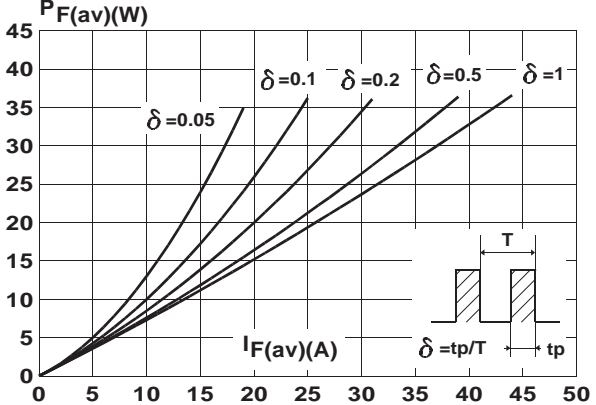

Fig.2 : Peak current versus form factor.

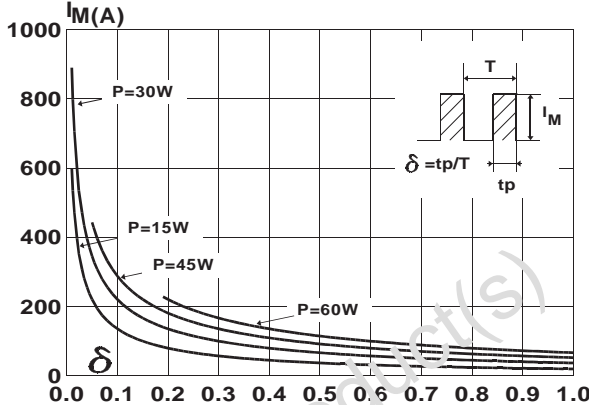

Fig.3 : Forward voltage drop versus forward current (maximum values).

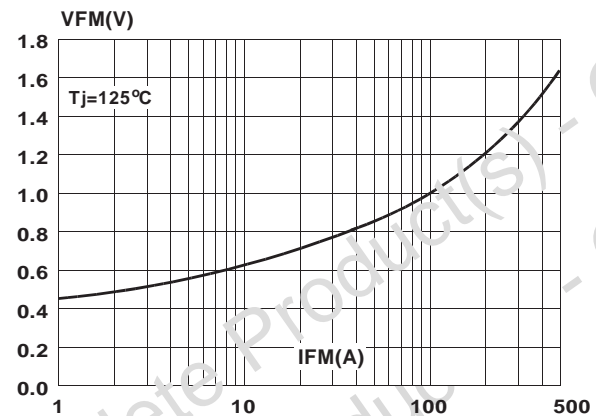

Fig.4 : Relative variation of thermal impedance junction to case versus pulse duration.

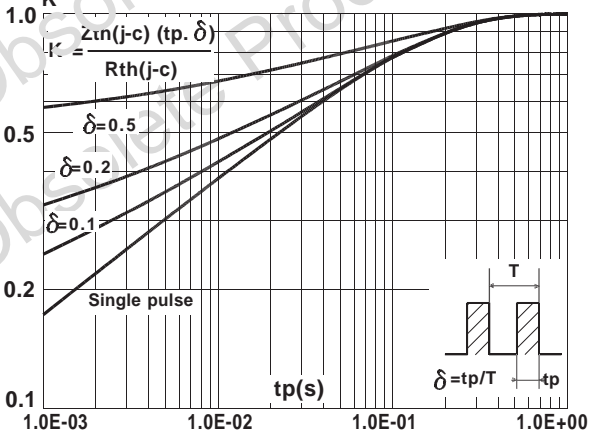

Fig.5 : Non repetitive surge peak forward current versus overload duration.

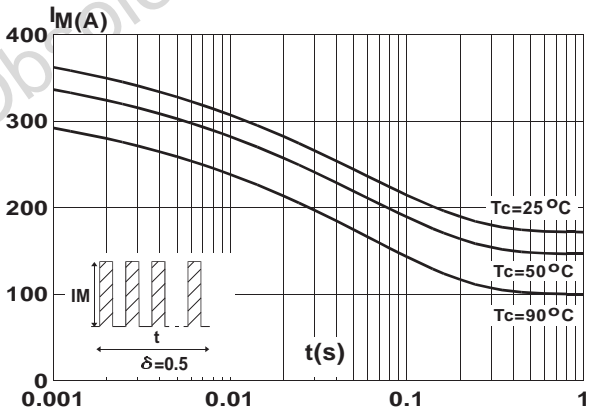
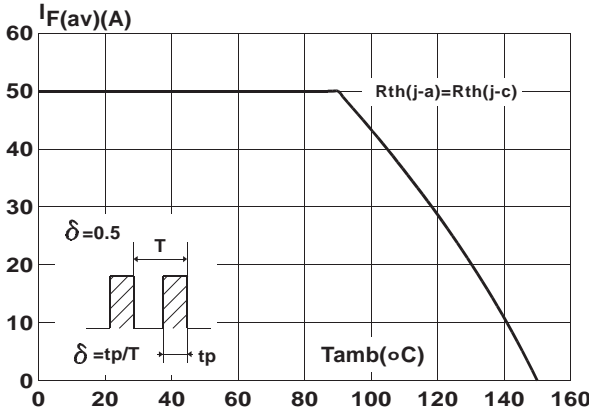

Fig.6 : Average current versus ambient temperature. (duty cycle : 0.5)



BYV54V / BYV541V

Fig.7 : Junction capacitance versus reverse voltage applied (Typical values).

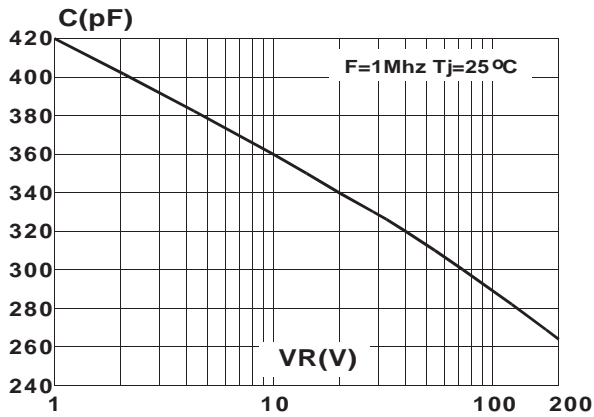

Fig.8 : Recovery charges versus dI_F/dt .

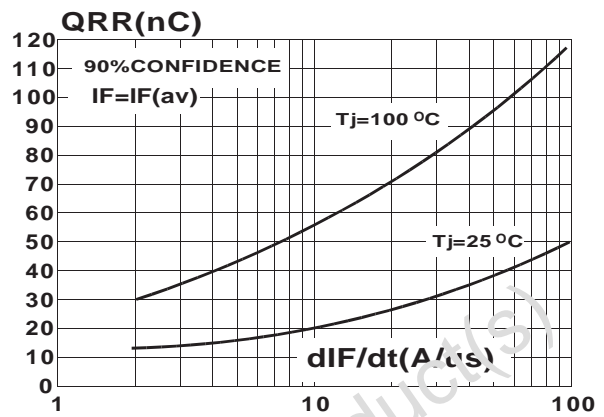

Fig.9 : Peak reverse current versus dI_F/dt .

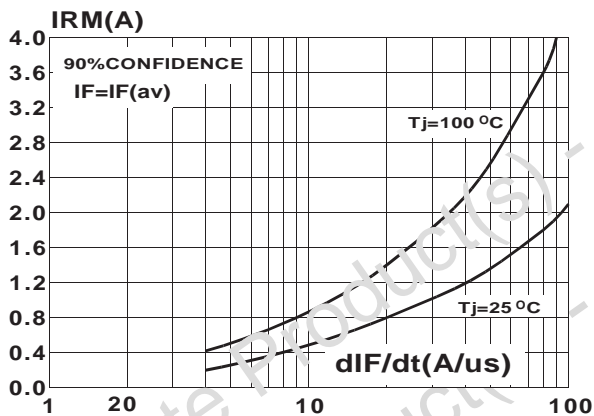
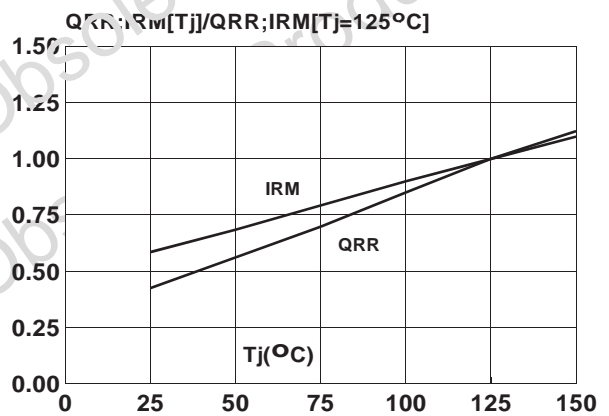

Fig.10 : Dynamic parameters versus junction temperature.



PACKAGE MECHANICAL DATA
ISOTOP

REF.	DIMENSIONS			
	Millimeters		Inches	
	Min.	Max.	Min.	Max.
A	11.80	12.20	0.465	0.480
A1	8.90	9.10	0.350	0.358
B	7.8	8.20	0.307	0.323
C	0.75	0.85	0.030	0.033
C2	1.95	2.05	0.077	0.081
D	37.80	38.20	1.488	1.504
D1	31.50	31.70	1.240	1.248
E	25.15	25.50	0.990	1.004
E1	23.85	24.15	0.939	0.951
E2	24.80 typ.		0.976 typ.	
G	14.90	15.10	0.587	0.594
G1	12.60	12.80	0.496	0.504
G2	3.50	4.30	0.138	0.169
F	4.10	4.30	0.161	0.169
F1	4.60	5.00	0.181	0.197
P	4.00	4.30	0.157	0.69
P1	4.00	4.40	0.157	0.173
S	30.10	30.30	1.185	1.193

- **Marking** : Type number
- Cooling method : C
- Weight : 27 g
- Epoxy meets UL94, V0

Information furnished is believed to be accurate and reliable. However, STMicroelectronics assumes no responsibility for the consequences of use of such information nor for any infringement of patents or other rights of third parties which may result from its use. No license is granted by implication or otherwise under any patent or patent rights of STMicroelectronics. Specifications mentioned in this publication are subject to change without notice. This publication supersedes and replaces all information previously supplied. STMicroelectronics products are not authorized for use as critical components in life support devices or systems without express written approval of STMicroelectronics.

The ST logo is a registered trademark of STMicroelectronics

© 2000 STMicroelectronics - Printed in Italy - All rights reserved.

STMicroelectronics GROUP OF COMPANIES

Australia - Brazil - China - Finland - France - Germany - Hong Kong - India - Italy - Japan - Malaysia
 Malta - Morocco - Singapore - Spain - Sweden - Switzerland - United Kingdom - U.S.A.

<http://www.st.com>