

Gen 2

# Conductivity Probe K 10

Platinum

Reads	<b>Conductivity</b>
Range	<b>10 <math>\mu</math>S/cm – 1 S/cm</b>
Accuracy	<b>+/- 2%</b>
Response time	<b>90% in 1s</b>
Temperature range °C	<b>1 – 110 °C</b>
Max pressure	<b>200 PSI</b>
Max depth	<b>141m (463 ft)</b>
Connector	<b>Male SMA / Male BNC</b> (Optional)
Cable length	<b>1 meter</b>
Internal temperature sensor	<b>No</b>
Time before recalibration	<b>~10 years</b>
Life expectancy	<b>~10 years</b>

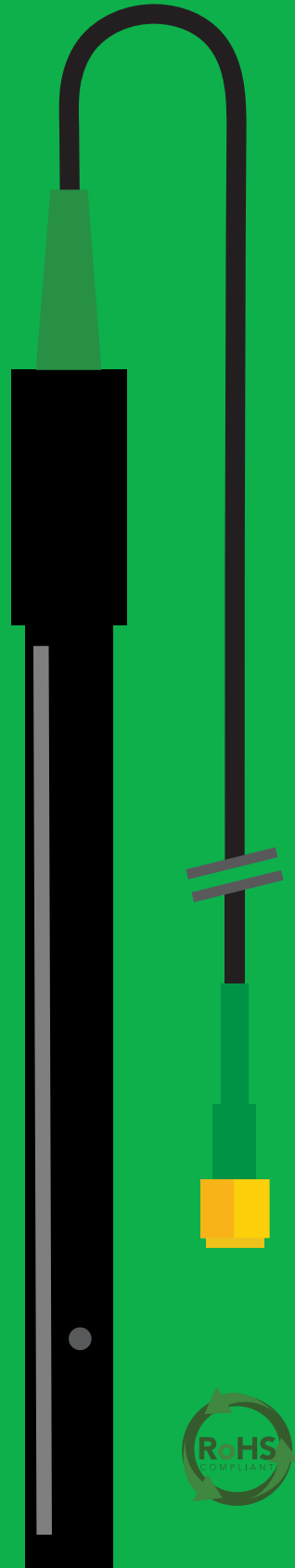

# Measurements

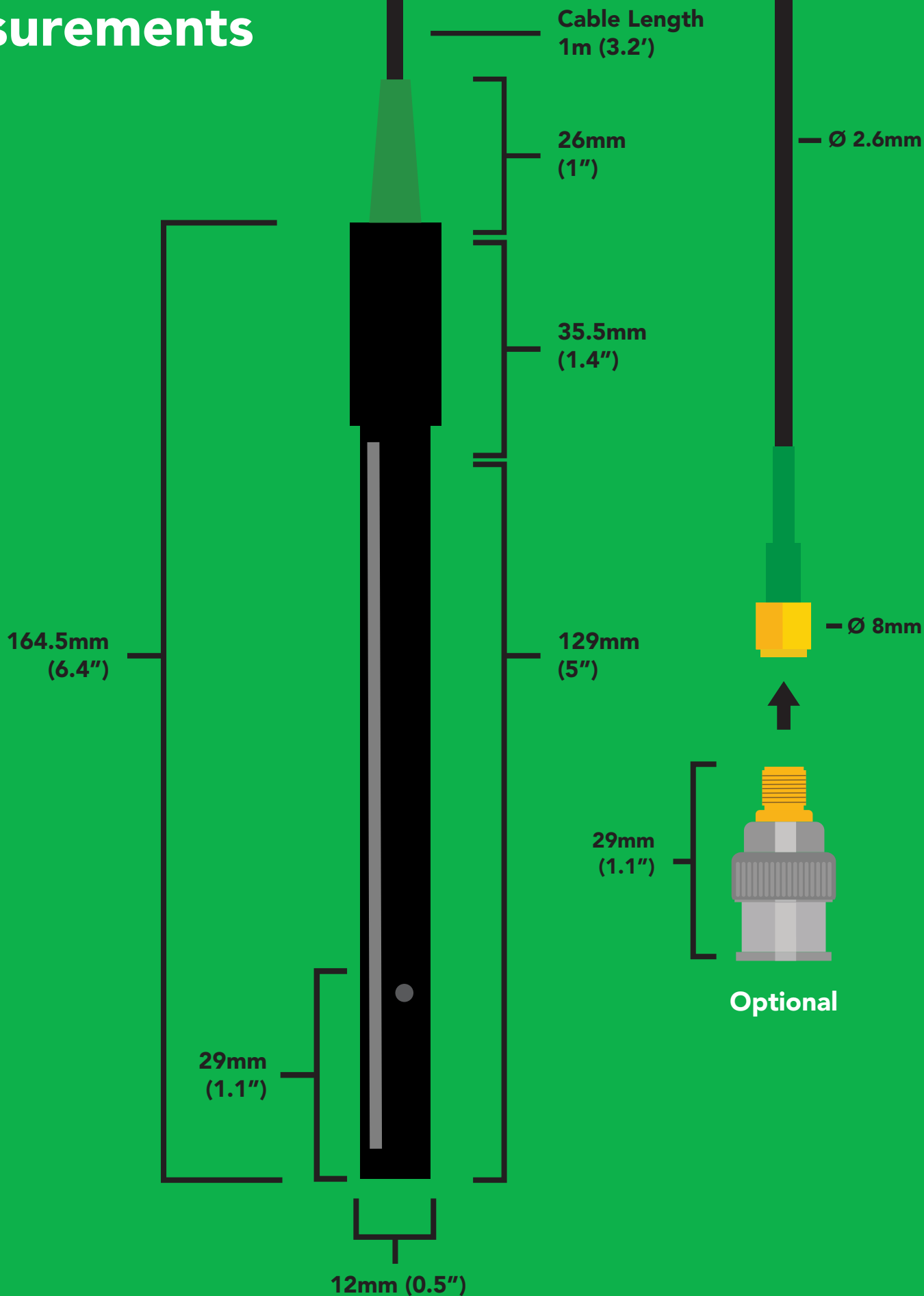

# Specifications

K 10	10 $\mu$ S/cm – 1 S/cm
Max depth	141m (463 ft)
Cable length	1 meter
Weight	51 grams
Speed of response	90% in 1 second
Measuring Surface	Platinum
Dimensions	12mm x 165.4mm (0.47" x 6.4")
SMA connector	Male
Sterilization	Chemical only
Food safe	Yes

# Materials

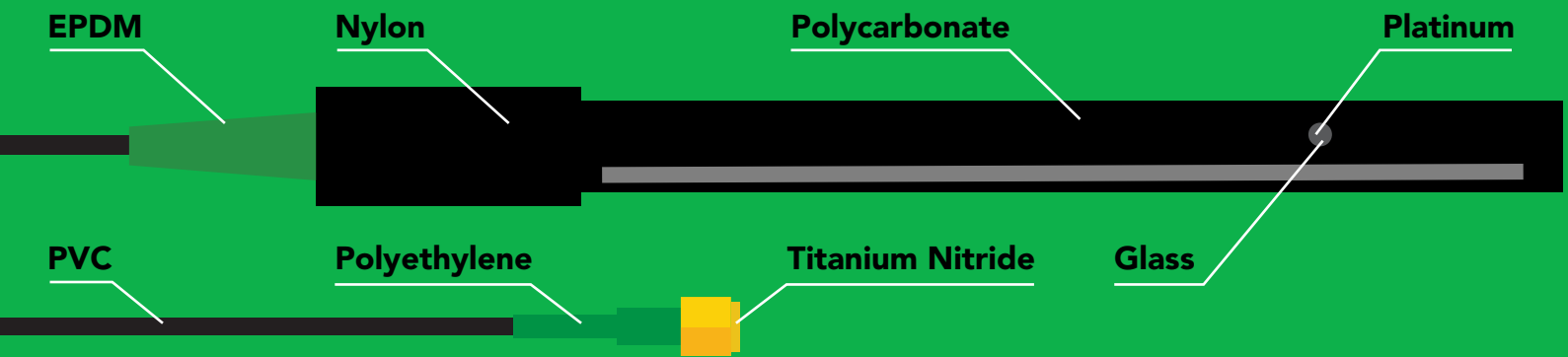

This Conductivity probe can be **fully submerged** in fresh or salt water, up to the SMA connector **indefinitely**.

# Typical applications

- Standard Lab use
- Field use
- Aquarium
- Hydroponics
- Fish keeping
- Mixed aqueous/organic
- Samples containing Heavy metals
- Soil Samples
- Strong reducing agents

# NSF/ANSI 51 Compliant

## Food Safe

Atlas Scientific LLC, hereby certifies that,

**Conductivity Probe K 10**  
**Part # ENV-40-EC-K10**

Complies with NSF/ANSI Standard 51

✓ **PVC**  
NSF-51 Compliant

✓ **EPDM**  
NSF-51 Compliant

✓ **Glass**  
NSF-51 Compliant

✓ **Nylon**  
NSF-51 Compliant

✓ **Platinum**  
NSF-51 Compliant

✓ **Polyethylene**  
NSF-51 Compliant

✓ **Polycarbonate**  
NSF-51 Compliant

✓ **Titanium Nitride**  
NSF-51 Compliant

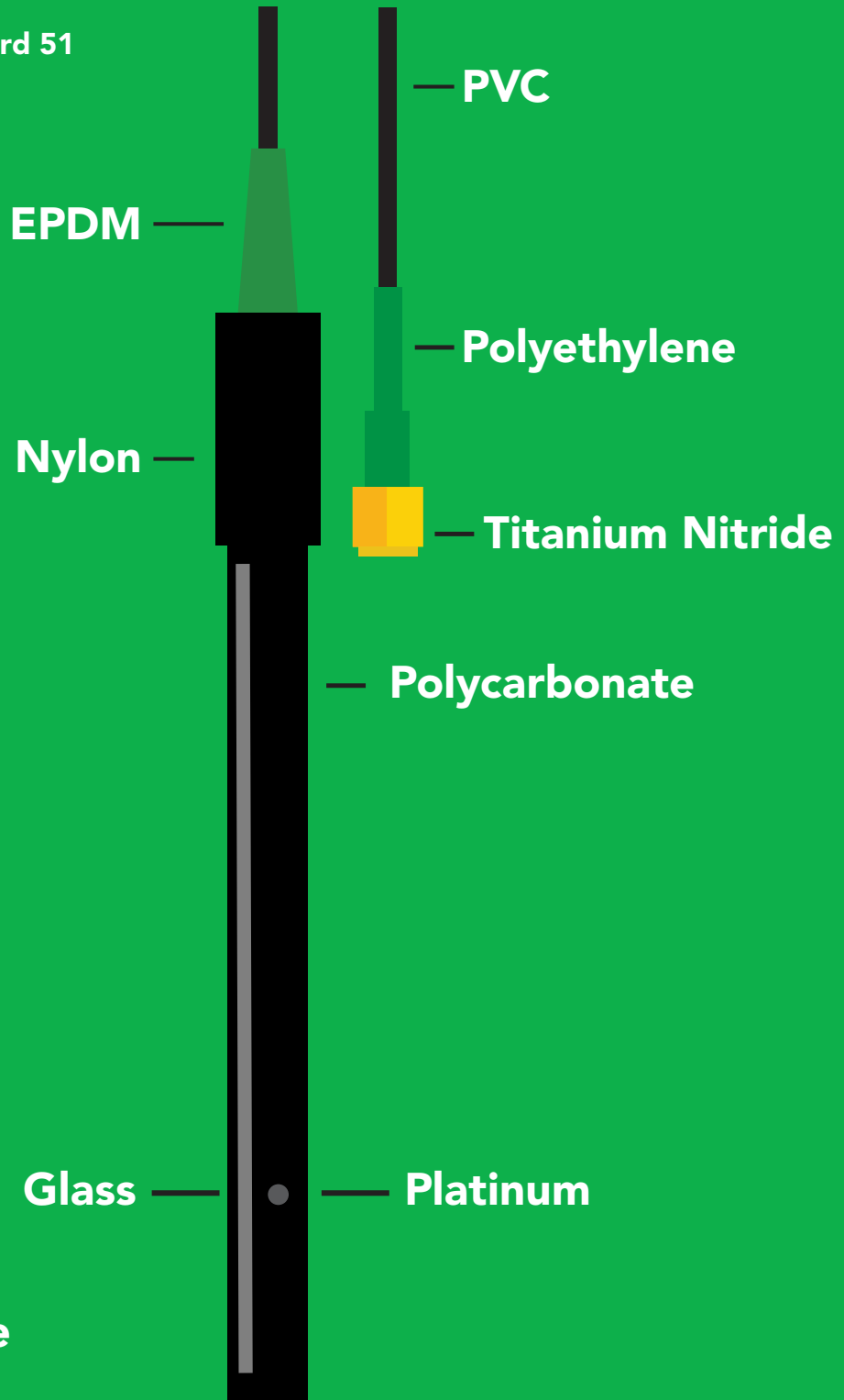

# Operating principle

An E.C. (**electrical conductivity**) probe measures the electrical conductivity in a solution. It is commonly used in hydroponics, aquaculture and freshwater systems to monitor the amount of nutrients, salts or impurities in the water.

Inside the conductivity probe, two electrodes are positioned opposite from each other, an AC voltage is applied to the electrodes causing cations to move to the negatively charged electrode, while the anions move to the positively electrode. The more free electrolyte the liquid contains, the higher the electrical conductivity.

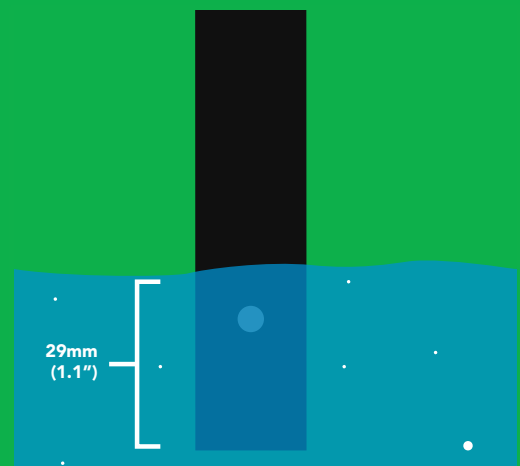
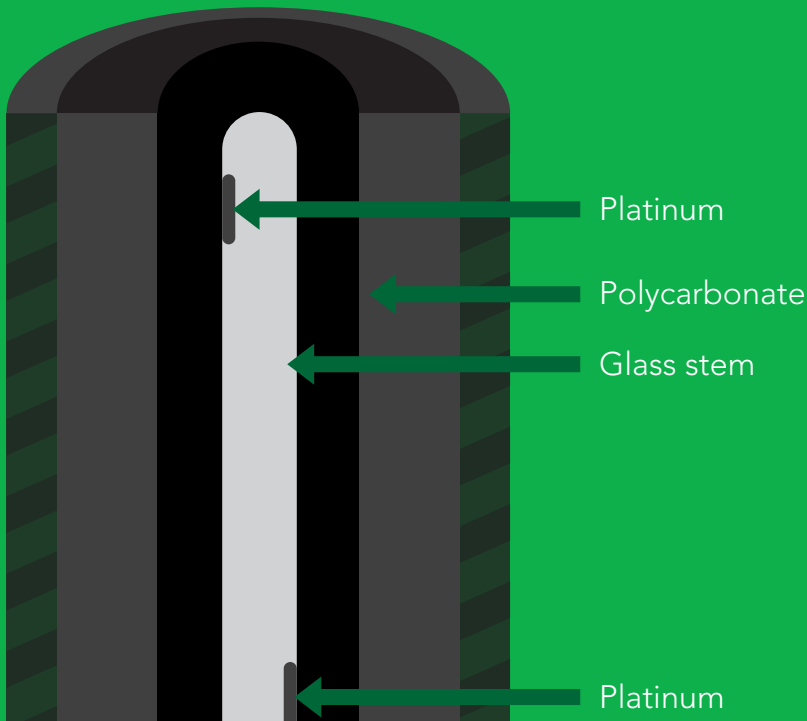
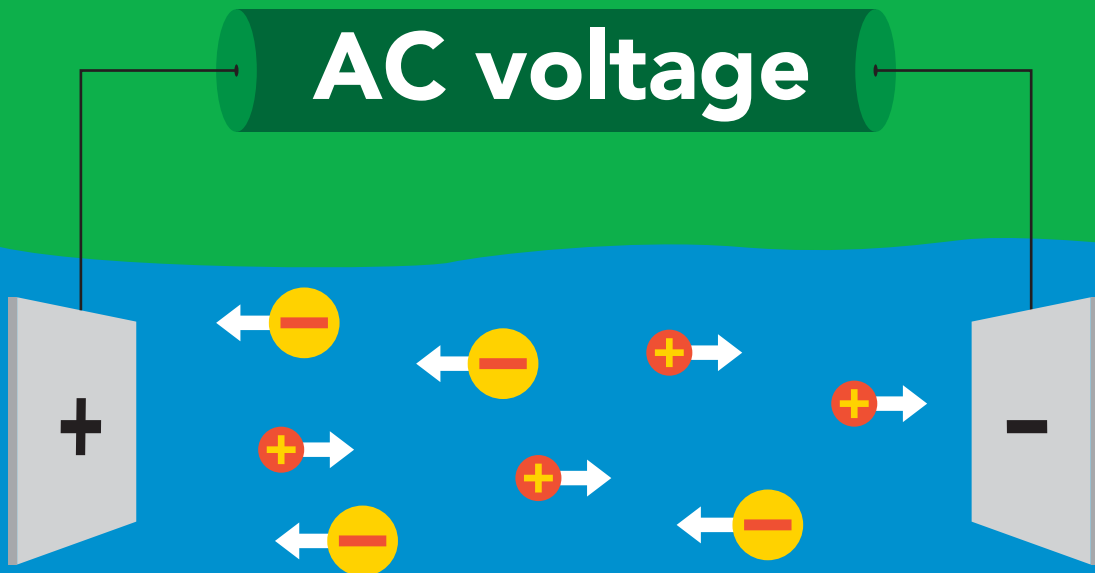

The entire conducting area must be submerged in order to get accurate readings.

A conductivity probe is a very simple device. It is just two conductors with a fixed surface area at a fixed distance from each other. This distance and surface area is known as the conductivity cell. The cells distance and surface area is quantified as the conductivity cells K constant.



Result will **always** read zero.

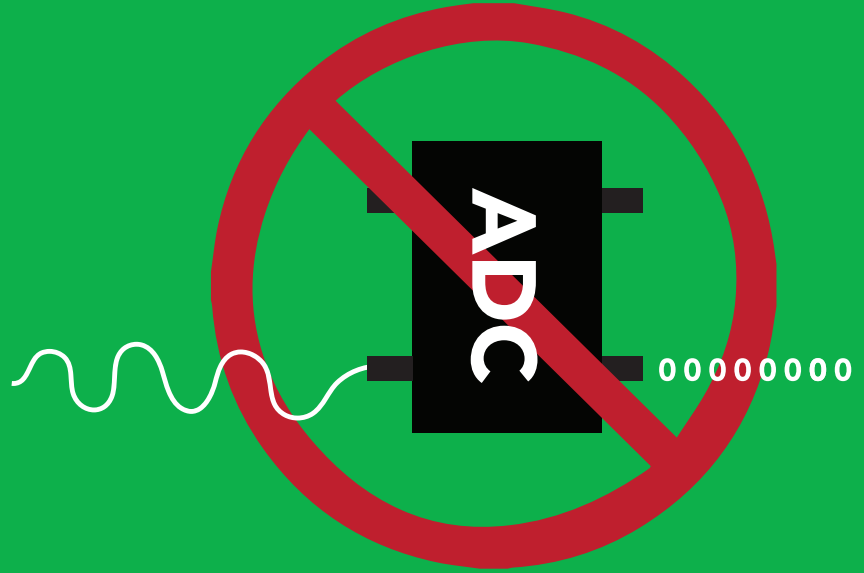

Result will **always** read zero.

## How often do you need to recalibrate a conductivity probe?

Conductivity probes work by measuring the electrical current of the water between two graphite plates. The plates do not go bad, or change, so recalibration is not necessary. After the first calibration your conductivity probe is good to go.

# Extending the probe cable length

You can extend the cable to greater than 100 meters with no loss of signal. Atlas Scientific has tested up to 300 meters without a problem, however you run the risk of turning your E.C. probe into an antennae, picking up noise along the length of your cable.

If you want to extend your cable, we recommend that you use proper isolation, such as the **Basic EZO™ Inline Voltage Isolator**, or **Tentacle Shield**. Be sure to calibrate your probe with the extended cable.

Extending a probe cable can be easily done with our **SMA Extension Cable**. Simply connect the SMA end of the probe to the Extension cable, and you are all set.

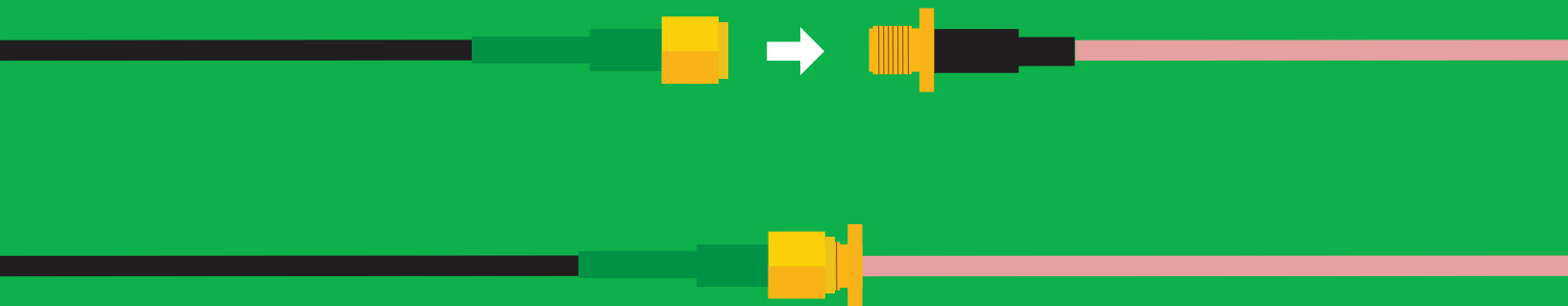

If you need to water proof a SMA connection, we highly recommend using a product like **Coax-Seal** to safely cover and prevent any water damage that may occur.

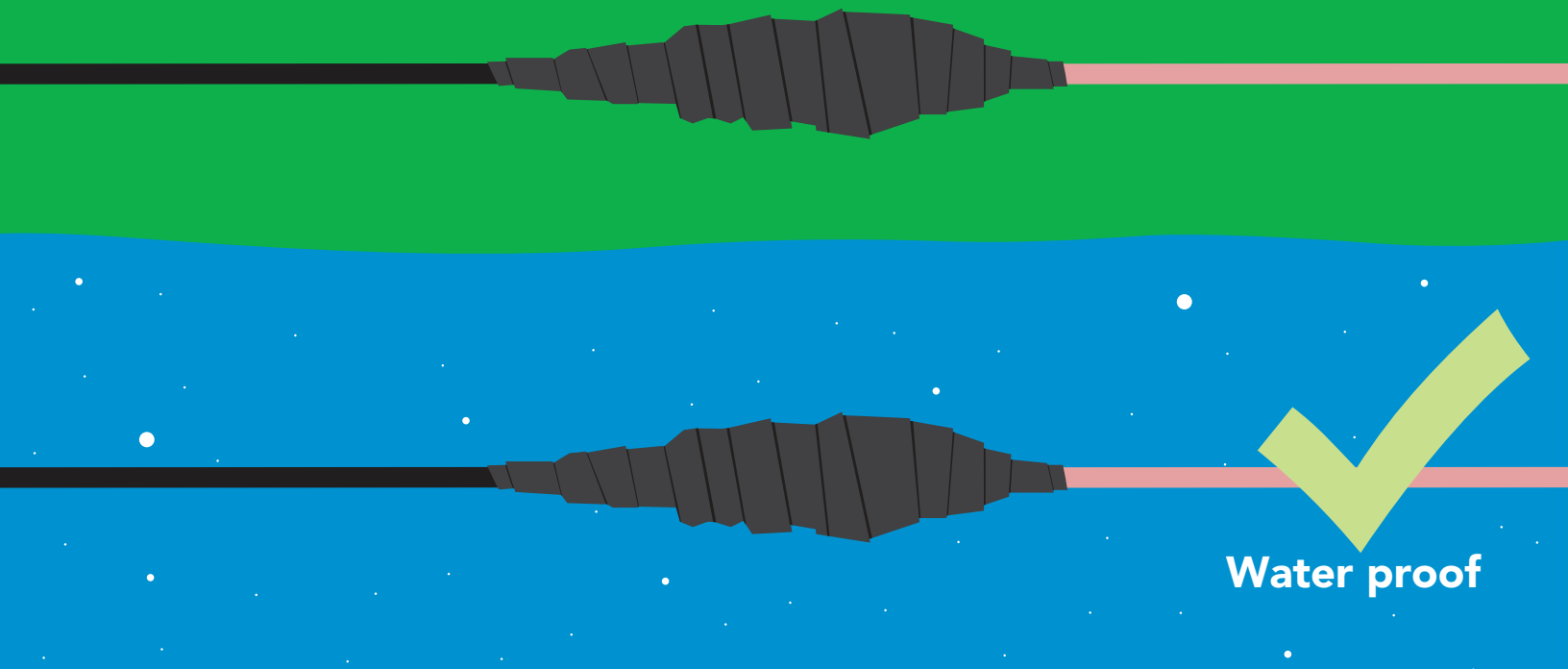

# Helpful operating tips

Be sure to watch out for air bubbles, as they can get caught inside the probe housing and throw off your results. Lightly tap your conductivity probe to knock out any bubbles caught in the probe.

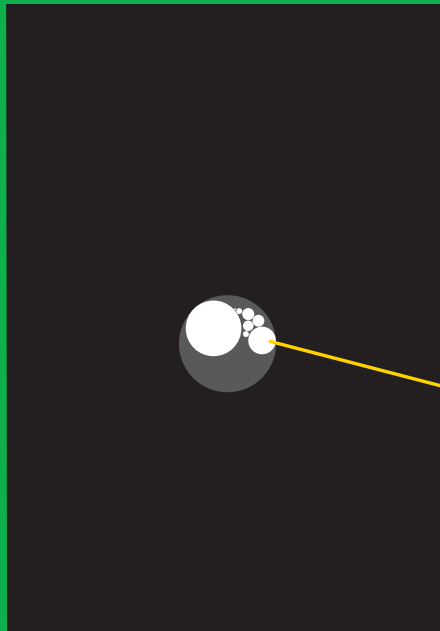

**Bubbles**



## Probe cleaning

Over time conductivity probes can become dirty and covered in deposits, which can change the basic electrical properties of the probe and cause inaccurate readings.

Cleaning the probe can be a bit tricky; you can't simply scrub it with a brush without destroying the fragile platinum conductors inside the probe.





# Probe cleaning

Both hard and soft coatings should be chemically removed. We highly recommend you use the **Atlas Scientific conductivity probe cleaner**.

