



# P-DUKE POWER

## RED40W Series

DC-DC Converter  
Up to 40 Watts

**3**  
YEARS  
WARRANTY

ROHS  
COMPLIANT

REACH  
COMPLIANT

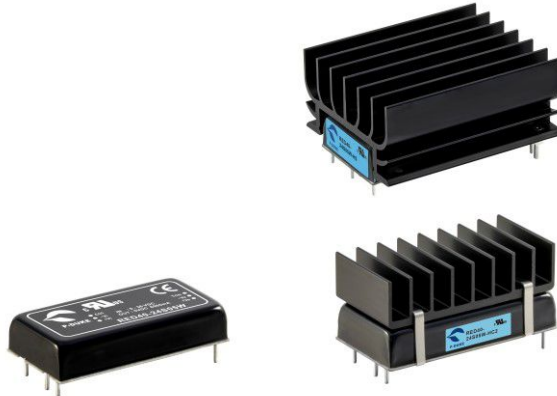

Railway



Automation



Datacom



IPC



Industry



Measurement



Telecom



Automobile



Boat



Charger



Medical



PV



**3000**  
VDC  
Isolation  
Voltage

**4 : 1**  
Wide  
Input  
Range

**6**  
sided  
Shielding

**LOW**  
Standby  
Power

**NO**  
Min. Load  
Required

**REMOTE**  
**ON**  
**OFF**

**OCP**

**OTP**

**OVP**

**SCP**

**UVP**

### PART NUMBER STRUCTURE

RED40 -	48	S	05	W	-	N	HS
Series Name	Input Voltage (VDC)	Output Quantity	Output Voltage (VDC)	Input Range	Remote On/Off Options	Assembly Options	
	24:9-36 48:18-75 110:36-160	S:Single  D: Dual	3P3: 3.3 05: 5 12: 12 15: 15 24: 24 48: 48 53: 53  12: ±12 15: ±15 24: ±24	4:1	□:Positive logic N:Negative logic	□: None HS: 7G-0110A-F HC1: 7GA0120P01-F; H=0.3" HC2: 7GA0121P01-F; H=0.5" HC3: 7GA0122P01-F; H=0.8"	

**TECHNICAL SPECIFICATION** All specifications are typical at nominal input, full load and 25°C unless otherwise noted

Model Number	Input Range	Output Voltage	Output Current @ Full Load	Input Current @ No Load	Efficiency	Maximum Capacitor Load
	VDC	VDC	mA	mA	%	μF
RED40-24S3P3W	9 ~ 36	3.3	12200	15	89.5	22000
RED40-24S05W	9 ~ 36	5	8000	15	92	12000
RED40-24S12W	9 ~ 36	12	3333	15	92	2000
RED40-24S15W	9 ~ 36	15	2666	15	93	1300
RED40-24S24W	9 ~ 36	24	1666	15	91	490
RED40-24S48W	9 ~ 36	48	833	15	91	120
RED40-24S53W	9 ~ 36	53	755	15	91.5	100
RED40-24D12W	9 ~ 36	±12	±1666	15	91	±980
RED40-24D15W	9 ~ 36	±15	±1333	15	91	±630
RED40-24D24W	9 ~ 36	±24	±833	15	91	±250
RED40-48S3P3W	18 ~ 75	3.3	12200	10	90	22000
RED40-48S05W	18 ~ 75	5	8000	10	91	12000
RED40-48S12W	18 ~ 75	12	3333	10	92	2000
RED40-48S15W	18 ~ 75	15	2666	10	92	1300
RED40-48S24W	18 ~ 75	24	1666	10	92	490
RED40-48S48W	18 ~ 75	48	833	10	92	120
RED40-48S53W	18 ~ 75	53	755	10	92	100
RED40-48D12W	18 ~ 75	±12	±1666	10	91	±980
RED40-48D15W	18 ~ 75	±15	±1333	10	91	±630
RED40-48D24W	18 ~ 75	±24	±833	10	92	±250
RED40-110S3P3W	36 ~ 160	3.3	12200	10	88	22000
RED40-110S05W	36 ~ 160	5	8000	10	91	12000
RED40-110S12W	36 ~ 160	12	3333	10	92	2000
RED40-110S15W	36 ~ 160	15	2666	10	92	1300
RED40-110S24W	36 ~ 160	24	1666	10	90.5	490
RED40-110S48W	36 ~ 160	48	833	10	91	120
RED40-110S53W	36 ~ 160	53	755	10	91	100
RED40-110D12W	36 ~ 160	±12	±1666	10	90.5	±980
RED40-110D15W	36 ~ 160	±15	±1333	10	90.5	±630
RED40-110D24W	36 ~ 160	±24	±833	10	91	±250

INPUT SPECIFICATIONS						
Parameter	Conditions		Min.	Typ.	Max.	Unit
Operating input voltage range	24Vin(nom)		9	24	36	VDC
	48Vin(nom)		18	48	75	
	110Vin(nom)		36	110	160	
Start up voltage	24Vin(nom)				9	VDC
	48Vin(nom)				18	
	110Vin(nom)				36	
Shutdown voltage	24Vin(nom)		7	8	8.8	VDC
	48Vin(nom)		15	16	17.5	
	110Vin(nom)		32	34	35.8	
Start up time	Constant resistive load	Power up Remote ON/OFF		30	60	ms
Input surge voltage	1 second, max.	24Vin(nom)			50	VDC
		48Vin(nom)			100	
		110Vin(nom)			200	
Input filter			Pi type			
Remote ON/OFF	Referred to -Vin pin	Positive logic DC-DC ON (Standard) DC-DC OFF	Open or 3 ~ 12VDC Short or 0 ~ 1.2VDC			
		Negative logic DC-DC ON (Option) DC-DC OFF	Short or 0 ~ 1.2VDC Open or 3 ~ 12VDC			
		Input current of Ctrl pin	-0.5		0.5	mA
		Remote off input current		3		mA

OUTPUT SPECIFICATIONS						
Parameter	Conditions		Min.	Typ.	Max.	Unit
Voltage accuracy			-1.0		+1.0	%
Line regulation	Low Line to High Line at Full Load		-0.2		+0.2	%
Load regulation	No Load to Full Load	Single	-0.5		+0.5	%
		Dual	-1.0		+1.0	
Cross regulation	Asymmetrical load 25%/100% FL		-5.0		+5.0	%
Voltage adjustability	Single output	Other	-10		+10	%
		15Vout, 24Vout	-10		+20	
Ripple and noise	Measured by 20MHz bandwidth With a 1µF/100V X7R MLCC	3.3Vout, 5Vout		75	100	mVp-p
		12Vout, 15Vout		100	125	
		24Vout		150	200	
		48Vout, 53Vout		300	350	
Temperature coefficient			-0.02		+0.02	%/°C
Transient response recovery time	25% load step change			250		µs
Over voltage protection	Zener diode clamp	3.3Vout		3.9		VDC
		5Vout		6.2		
		12Vout		15		
		15Vout		20		
		24Vout		30		
		48Vout 53Vout		60 63		
Over load protection	% of lout rated; Hiccup mode			150		%
Short circuit protection			Continuous, automatics recovery			

**GENERAL SPECIFICATIONS**

Parameter	Conditions	Min.	Typ.	Max.	Unit
Isolation voltage	1 minute Input to Output Input (Output) to Case	3000 2250			VDC
Isolation resistance	500VDC	1			GΩ
Isolation capacitance				1500	pF
Switching frequency		200	250	275	kHz
Safety approvals	IEC /UL/ EN62368-1				UL:E193009 CB:UL(Demko)
Standard approvals	EN50155 EN45545-2				
Case material					Copper
Base material					FR4 PCB
Potting material					Silicone (UL94 V-0)
Weight					34g (1.2oz)
MTBF	MIL-HDBK-217F, Full load				1.245 x 10 <sup>6</sup> hrs

**ENVIRONMENTAL SPECIFICATIONS**

Parameter	Conditions	Min.	Typ.	Max.	Unit
Operating ambient temperature	With derating	-40		+105	°C
Maximum case temperature				105	°C
Over temperature protection			115		°C
Storage temperature range		-55		+125	°C
Thermal impedance	Natural convection Without Heat-sink With Heat-sink HC1 HC2 HC3 · HS		10.8 9.3 7.7 6.2		°C/W
Thermal shock					MIL-STD-810F
Shock					EN61373, MIL-STD-810F
Vibration					EN61373, MIL-STD-810F
Relative humidity					5% to 95% RH

**EMC SPECIFICATIONS**

Parameter	Conditions	Level
EMI	EN55032,EN50121-3-2 With external components	Class A, Class B
EMS	EN55035,EN50121-3-2	
ESD	EN61000-4-2 Air ± 8kV and Contact ± 6kV	Perf. Criteria A
Radiated immunity	EN61000-4-3 20V/m	Perf. Criteria A
Fast transient	EN61000-4-4 ± 2kV	Perf. Criteria A
	RED40-24□□□W With 2 pcs of aluminum electrolytic capacitor (Nippon chemi-con KY series, 220μF/100V) and a TVS (SMDJ58A, 58V, 3000Watt peak pulse power) in parallel.	
	RED40-48□□□W With 2 pcs of aluminum electrolytic capacitor (Nippon chemi-con KY series, 220μF/100V) and a TVS (SMDJ120A, 120V, 3000Watt peak pulse power) in parallel.	
	RED40-110□□□W With 2 pcs of aluminum electrolytic capacitor (Nippon chemi-con KXJ series, 150μF/200V) and a TVS (SMDJ170A, 170V, 3000Watt peak pulse power) in parallel.	

**EMC SPECIFICATIONS(CONTINUED)**

Parameter	Conditions	Level
Surge	EN61000-4-5 ± 2kV	Perf. Criteria A
	RED40-24□□□W With 2 pcs of aluminum electrolytic capacitor (Nippon chemi-con KY series, 220μF/100V) and a TVS (SMDJ58A, 58V, 3000Watt peak pulse power) in parallel.	
	RED40-48□□□W With 2 pcs of aluminum electrolytic capacitor (Nippon chemi-con KY series, 220μF/100V) and a TVS (SMDJ120A, 120V, 3000Watt peak pulse power) in parallel.	
	RED40-110□□□W With 2 pcs of aluminum electrolytic capacitor (Nippon chemi-con KXJ series, 150μF/200V) and a TVS (SMDJ170A, 170V, 3000Watt peak pulse power) in parallel.	
Conducted immunity	EN61000-4-6 10Vr.m.s	Perf. Criteria A
Power frequency magnetic field	EN61000-4-8 100A/m continuous; 1000A/m 1 second	Perf. Criteria A

## CHARACTERISTIC CURVE

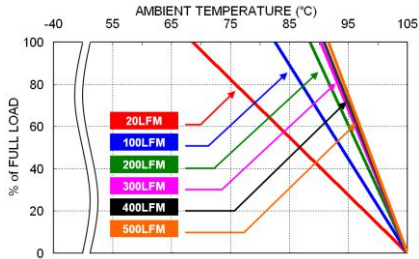

RED40-24S05W Derating Curve

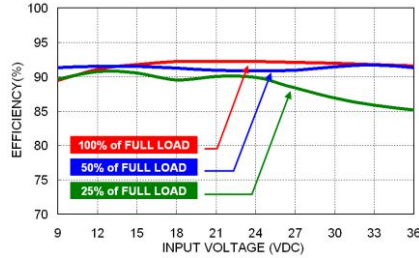

RED40-24S05W Efficiency vs. Input Voltage

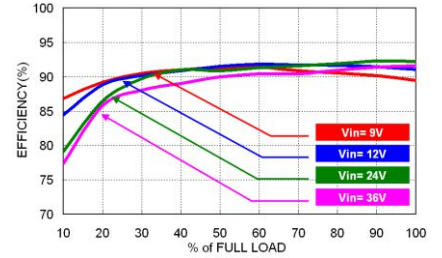

RED40-24S05W Efficiency vs. Output Load

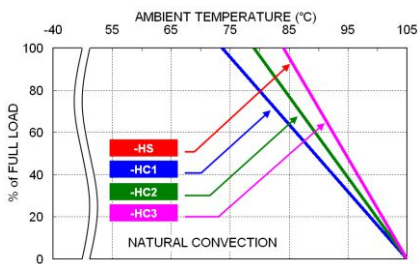

RED40-24S05W Derating Curve With Heat-sink

## FUSE CONSIDERATION

This power module is not internally fused. An input line fuse must always be used.

This encapsulated power module can be used in a wide variety of applications, ranging from simple stand-alone operation to an integrated part of sophisticated power architecture.

To maximum flexibility, internal fusing is not included; however, to achieve maximum safety and system protection, always use an input line fuse.

The input line fuse suggest as below :

Model	Fuse Rating (A)	Fuse Type
RED40-24□□□W	8	Fast-Acting
RED40-48□□□W	4	Slow-Blow
RED40-110□□□W	3.15	Slow-Blow

The table based on the information provided in this data sheet on inrush energy and maximum DC input current at low Vin.

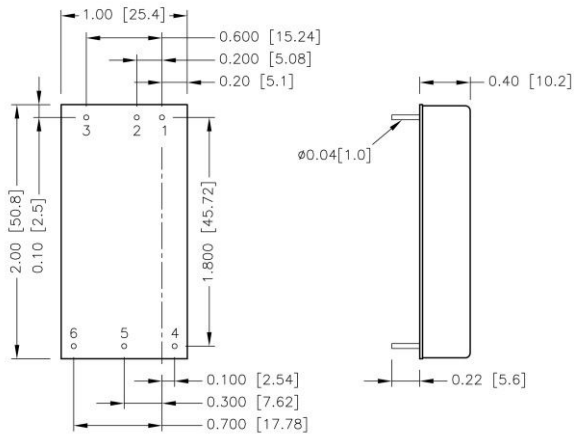
**MECHANICAL DRAWING**
**Standard 、 -HC1 、 -HC2 、 -HC3**

BOTTOM VIEW

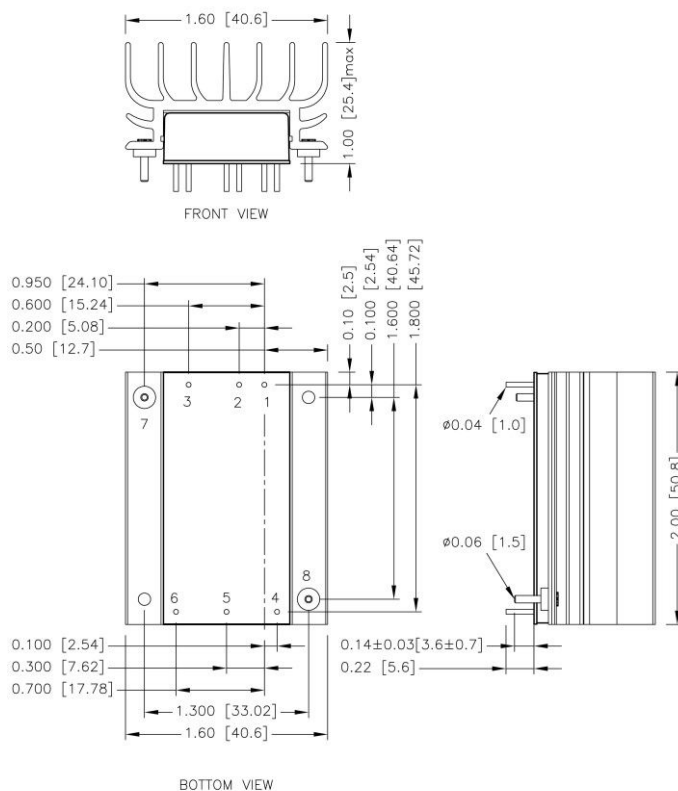
**-HS**

BOTTOM VIEW

**PIN CONNECTION**

PIN	SINGLE	DUAL
1	+ Vin	+ Vin
2	- Vin	- Vin
3	Ctrl	Ctrl
4	+ Vout	+ Vout
5	- Vout	Com
6	Trim	- Vout

- All dimensions in inch [mm]  
Tolerance :x.xx±0.02 [x.x±0.5]  
x.xxx±0.010 [x.xx±0.25]
- Pin dimension tolerance ±0.004[0.10]

**PIN CONNECTION**

PIN	SINGLE	DUAL
1	+ Vin	+ Vin
2	- Vin	- Vin
3	Ctrl	Ctrl
4	+ Vout	+ Vout
5	- Vout	Com
6	Trim	- Vout
7	Heat-sink	Heat-sink
8	Heat-sink	Heat-sink

- All dimensions in inch [mm]  
Tolerance :x.xx±0.02 [x.x±0.5]  
x.xxx±0.010 [x.xx±0.25]
- Pin dimension tolerance ±0.004[0.10]

## RECOMMENDED PAD LAYOUT

### Standard

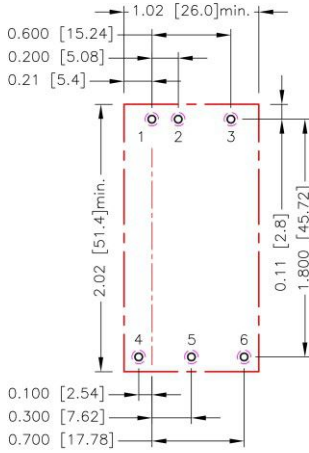

All dimensions in inch[mm]  
 Pad size(lead free recommended)  
 Through hole 1.2.3.4.5.6:  $\Phi 0.051[1.30]$   
 Top view pad 1.2.3.4.5.6:  $\Phi 0.064[1.63]$   
 Bottom view pad 1.2.3.4.5.6:  $\Phi 0.102[2.60]$

### -HS

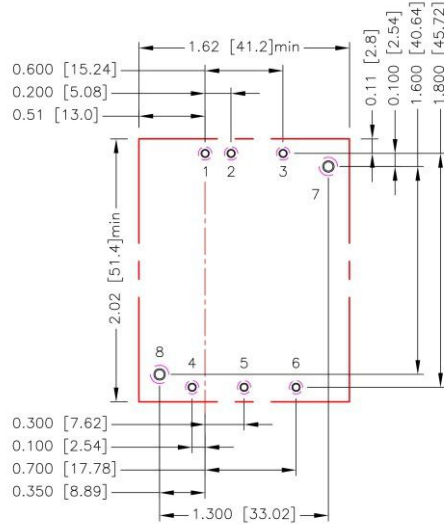

All dimensions in inch[mm]  
 Pad size(lead free recommended)  
 Through hole 1.2.3.4.5.6:  $\Phi 0.051[1.30]$   
 Through hole 7.8:  $\Phi 0.071[1.80]$   
 Top view pad 1.2.3.4.5.6:  $\Phi 0.064[1.63]$   
 Top view pad 7.8:  $\Phi 0.089[2.25]$   
 Bottom view pad 1.2.3.4.5.6:  $\Phi 0.102[2.60]$   
 Bottom view pad 7.8:  $\Phi 0.142[3.60]$

### -HC1、-HC2、-HC3

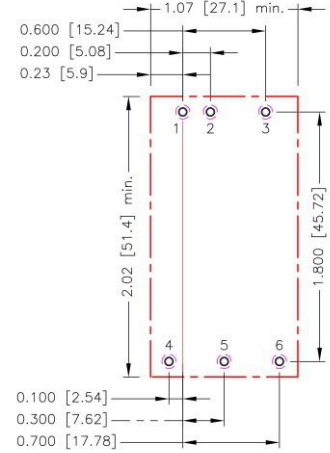

All dimensions in inch[mm]  
 Pad size(lead free recommended)  
 Through hole 1.2.3.4.5.6:  $\Phi 0.051[1.30]$   
 Top view pad 1.2.3.4.5.6:  $\Phi 0.064[1.63]$   
 Bottom view pad 1.2.3.4.5.6:  $\Phi 0.102[2.60]$

## THERMAL CONSIDERATIONS

The power module operates in a variety of thermal environments. However, sufficient cooling should be provided to help ensure reliable operation of the unit. Heat is removed by conduction, convection, and radiation to the surrounding environment. Proper cooling can be verified by measuring the point as the figure below. The temperature at this location should not exceed "Maximum case temperature". When operating, adequate cooling must be provided to maintain the test point temperature at or below "Maximum case temperature". You can limit this temperature to a lower value for extremely high reliability.

- Thermal test condition with vertical direction by natural convection (20LFM).

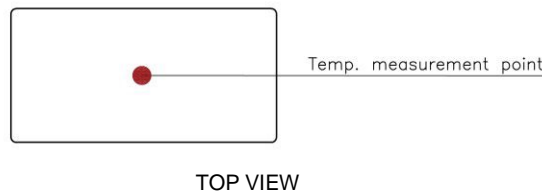



**HEAT-SINK TYPE OPTIONS**

RED40-□□□□□W-**HS**  
7G-0110A-F

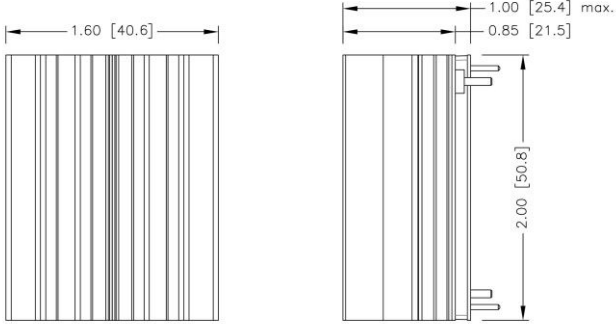

SIDE VIEW

RED40-□□□□□W-**HC1**  
7GA0120P01-F

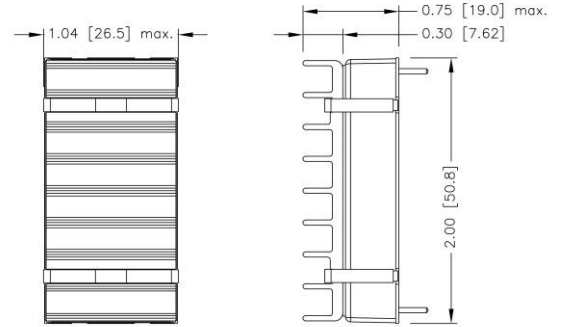

SIDE VIEW

RED40-□□□□□W-**HC2**  
7GA0121P01-F

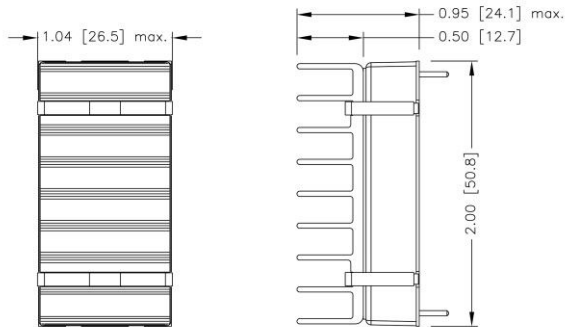

SIDE VIEW

RED40-□□□□□W-**HC3**  
7GA0122P01-F

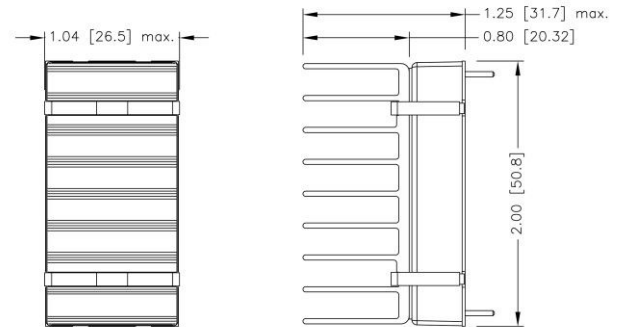

SIDE VIEW

1. All dimensions in inch [mm]
2. Tolerance :x.xx±0.02 [x.x±0.5]  
x.xxx±0.010 [x.xx±0.25]

## OUTPUT VOLTAGE ADJUSTMENT

It allows the user to increase or decrease the output voltage of the module.  
 This is accomplished by connecting an external resistor between the Trim pin and either the +Vout or -Vout pins.  
 With an external resistor between the Trim and -Vout pin, the output voltage increases.  
 With an external resistor between the Trim and +Vout pin, the output voltage decreases.  
 The external Trim resistor needs to be at least 1/8W of rated power.

### EXTERNAL OUTPUT TRIMMING

Output can be externally trimmed by using the method shown below.

#### Trim-up

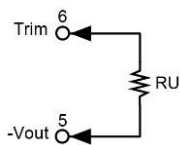

□□S3P3W										
$\Delta V$ (%)	1	2	3	4	5	6	7	8	9	10
Vout (V)	3.333	3.366	3.399	3.432	3.465	3.498	3.531	3.564	3.597	3.630
RU (k $\Omega$ )	43.179	21.758	13.410	8.966	6.206	4.325	2.961	1.927	1.115	0.462

□□S05W										
$\Delta V$ (%)	1	2	3	4	5	6	7	8	9	10
Vout (V)	5.05	5.10	5.15	5.20	5.25	5.30	5.35	5.40	5.45	5.50
RU (k $\Omega$ )	35.360	16.244	9.752	6.483	4.514	3.198	2.257	1.550	1.000	0.559

□□S12W										
$\Delta V$ (%)	1	2	3	4	5	6	7	8	9	10
Vout (V)	12.12	12.24	12.36	12.48	12.60	12.72	12.84	12.96	13.08	13.20
RU (k $\Omega$ )	392.864	172.175	101.446	66.591	45.837	32.068	22.264	14.929	9.234	4.685

□□S15W										
$\Delta V$ (%)	1	2	3	4	5	6	7	8	9	10
Vout (V)	15.15	15.30	15.45	15.60	15.75	15.90	16.05	16.20	16.35	16.50
RU (k $\Omega$ )	413.163	198.115	125.754	89.445	67.618	53.050	42.636	34.820	28.739	23.872

□□S15W										
$\Delta V$ (%)	11	12	13	14	15	16	17	18	19	20
Vout (V)	16.65	16.80	16.95	17.10	17.25	17.40	17.55	17.70	17.85	18.00
RU (k $\Omega$ )	19.888	16.568	13.759	11.350	9.262	7.434	5.822	4.389	3.106	1.951

□□S24W										
$\Delta V$ (%)	1	2	3	4	5	6	7	8	9	10
Vout (V)	24.24	24.48	24.72	24.96	25.20	25.44	25.68	25.92	26.16	26.40
RU (k $\Omega$ )	947.146	472.772	303.499	216.605	163.724	128.153	102.589	83.329	68.298	56.240

□□S24W										
$\Delta V$ (%)	11	12	13	14	15	16	17	18	19	20
Vout (V)	26.64	26.88	27.12	27.36	27.60	27.84	28.08	28.32	28.56	28.80
RU (k $\Omega$ )	46.353	38.099	31.104	25.101	19.892	15.330	11.302	7.718	4.509	1.619

□□S48W										
$\Delta V$ (%)	1	2	3	4	5	6	7	8	9	10
Vout (V)	48.48	48.96	49.44	49.92	50.40	50.88	51.36	51.84	52.32	52.80
RU (k $\Omega$ )	531.639	226.403	131.987	86.042	58.867	40.910	28.162	18.642	11.263	5.376

□□S53W										
$\Delta V$ (%)	1	2	3	4	5	6	7	8	9	10
Vout (V)	53.53	54.06	54.59	55.12	55.65	56.18	56.71	57.24	57.77	58.30
RU (k $\Omega$ )	626.943	246.365	140.489	90.768	61.891	43.022	29.726	19.853	12.231	6.169

**OUTPUT VOLTAGE ADJUSTMENT(CONTINUED)**

Trim-down

**□□S3P3W**

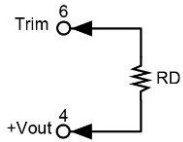
$\Delta V$ (%)	1	2	3	4	5	6	7	8	9	10
Vout (V)	3.267	3.234	3.201	3.168	3.135	3.102	3.069	3.036	3.003	2.970
RD (k $\Omega$ )	68.728	31.256	18.592	12.227	8.398	5.841	4.012	2.639	1.570	0.715

**□□S05W**

$\Delta V$ (%)	1	2	3	4	5	6	7	8	9	10
Vout (V)	4.95	4.90	4.85	4.80	4.75	4.70	4.65	4.60	4.55	4.50
RD (k $\Omega$ )	46.686	20.817	12.360	8.162	5.653	3.984	2.794	1.903	1.210	0.656

**□□S12W**

$\Delta V$ (%)	1	2	3	4	5	6	7	8	9	10
Vout (V)	11.88	11.76	11.64	11.52	11.40	11.28	11.16	11.04	10.92	10.80
RD (k $\Omega$ )	435.294	201.116	120.429	79.573	54.894	38.371	26.535	17.639	10.709	5.157

**□□S15W**

$\Delta V$ (%)	1	2	3	4	5	6	7	8	9	10
Vout (V)	14.85	14.70	14.55	14.40	14.25	14.10	13.95	13.80	13.65	13.50
RD (k $\Omega$ )	302.154	132.978	78.547	51.685	35.680	25.055	17.489	11.826	7.429	3.916

**□□S24W**

$\Delta V$ (%)	1	2	3	4	5	6	7	8	9	10
Vout (V)	23.76	23.52	23.28	23.04	22.80	22.56	22.32	22.08	21.84	21.60
RD (k $\Omega$ )	736.063	326.672	192.473	125.790	85.913	59.383	40.459	26.282	15.263	6.454

**□□S48W**

$\Delta V$ (%)	1	2	3	4	5	6	7	8	9	10
Vout (V)	47.52	47.04	46.56	46.08	45.60	45.12	44.64	44.16	43.68	43.20
RD (k $\Omega$ )	558.604	257.390	153.744	101.292	69.616	48.413	33.225	21.811	12.920	5.798

**□□S53W**

$\Delta V$ (%)	1	2	3	4	5	6	7	8	9	10
Vout (V)	52.47	51.94	51.41	50.88	50.35	49.82	49.29	48.76	48.23	47.70
RD (k $\Omega$ )	551.986	256.323	153.564	101.358	69.765	48.589	33.408	21.991	13.093	5.962