

WiFi Dual Band Ceramic Chip Antenna (AA077) with Evaluation Board

Engineering Specification

1. Product Number

H 2 B 1 P G 1 A 1 C 0 2 0 0

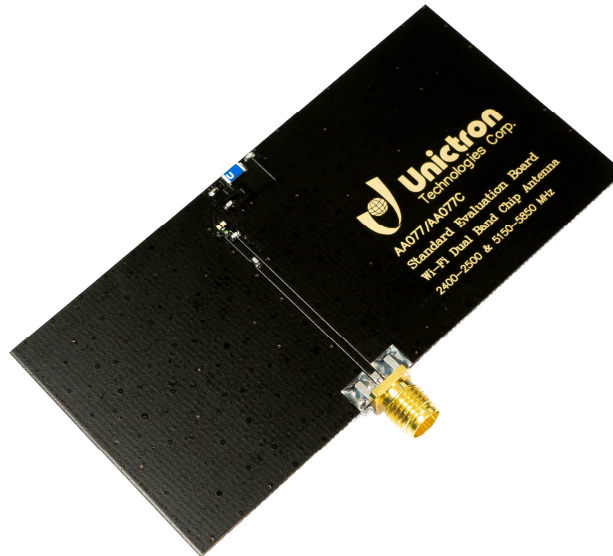

2. Features

- *Stable and reliable performances in both 2.4 and 5 GHz bands
- *Low profile and compact size
- *RoHS compliance
- *SMT processes compatible

3. Applications

- *Wi-Fi CERTIFIED ac applications
- *Wireless communication devices when IEEE802.11 a/b/g/n/ac functions are needed.
- *IoT applications

4. Description

Unictron's AA077 ceramic chip antenna is designed for Wi-Fi CERTIFIED ac applications, covering both 2400~2500 MHz & 5150~5850 MHz frequency bands. Fabricated with proprietary design and processes, AA077 shows excellent performance and is fully compatible with SMT processes which can reduce the assembly cost and improve device's quality and consistency.



詠業科技股份有限公司
Unictron Technologies Corporation
Website: www.unictron.com

THIS DRAWINGS AND SPECIFICATIONS ARE THE PROPERTY OF UNICTRON TECHNOLOGIES CORPORATION AND SHALL NOT BE REPRODUCED OR USED AS THE BASIS FOR THE MANUFACTURE OR SALE OF APPARATUS OR DEVICES WITHOUT PERMISSION

Prepared by : Xenia

Designed by : Phillip

Checked by : Mike

Approved by : Herbert

TITLE : WiFi Dual Band Ceramic Chip Antenna (AA077) with Evaluation Board Engineering Specification

DOCUMENT NO.

H2B1PG1A1C0200

REV. A

5. Layout Guide & Electrical Specifications

5-1. Layout Guide (unit : mm)

Solder Land Pattern:

The solder land pattern (gold marking areas) is shown below. Recommendation on matching circuit will be provided according to customer's installation conditions.

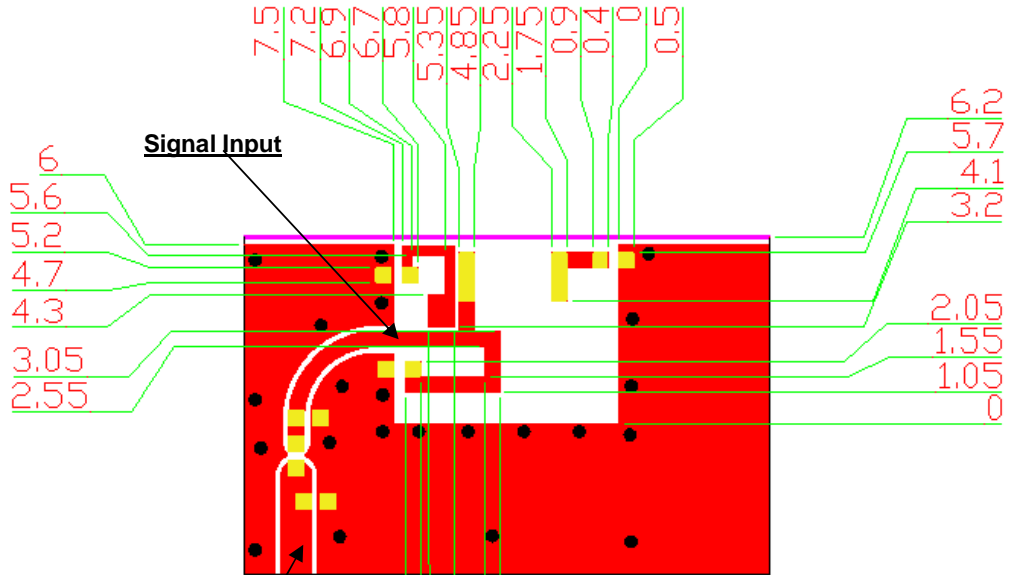

Transmission Line with 50Ω Impedance Characteristic

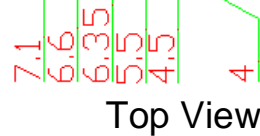

Top View

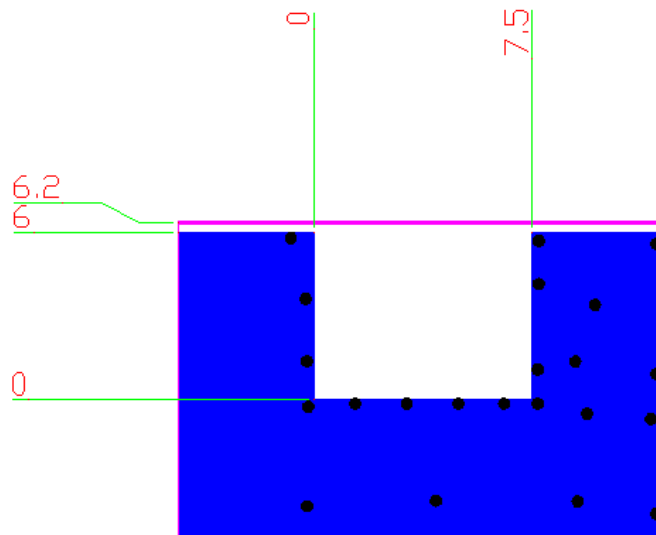

Bottom View



詠業科技股份有限公司
Unictron Technologies Corporation
Website: www.unictron.com

THIS DRAWINGS AND SPECIFICATIONS ARE THE PROPERTY OF UNICTRON TECHNOLOGIES CORPORATION AND SHALL NOT BE REPRODUCED OR USED AS THE BASIS FOR THE MANUFACTURE OR SALE OF APPARATUS OR DEVICES WITHOUT PERMISSION

Prepared by : Xenia

Designed by : Phillip

Checked by : Mike

Approved by : Herbert

TITLE : WiFi Dual Band Ceramic Chip Antenna (AA077) with Evaluation Board Engineering Specification

DOCUMENT NO.

H2B1PG1A1C0200

REV.

A

5-2. Electrical Specifications (Evaluation Board Dimensions: 80 x 40 mm²)

5-2-1. Electrical Table (2400~2500 MHz Band)

Characteristics		Specifications	Unit
Outline Dimensions		3.2 x 1.6 x 0.5	mm
Ground Plane Dimensions		80 x 40	mm
Working Frequency		2400~2500	MHz
VSWR(@ center frequency)*		2 Max.	
Characteristic Impedance		50	Ω
Polarization		Linear Polarization	
Peak Gain	(@2442 MHz)	1.4 (typical)	dBi
Efficiency		76 (typical)	%

*Center frequency means the frequency with the lowest value in return loss of the chip antenna on the evaluation board.

5-2-2. Electrical Table (5150~5850 MHz Band)

Characteristics		Specifications	Unit
Working Frequency		5150~5850	MHz
VSWR(@ center frequency)*		2 Max.	
Characteristic Impedance		50	Ω
Polarization		Linear Polarization	
Peak Gain	(@5550 MHz)	2.3 (typical)	dBi
Efficiency		67 (typical)	%

*Center frequency means the frequency with the lowest value in return loss of the chip antenna on the evaluation board.



詠業科技股份有限公司
Unictron Technologies Corporation
Website: www.unictron.com

THIS DRAWINGS AND SPECIFICATIONS ARE THE PROPERTY OF UNICTRON TECHNOLOGIES CORPORATION AND SHALL NOT BE REPRODUCED OR USED AS THE BASIS FOR THE MANUFACTURE OR SALE OF APPARATUS OR DEVICES WITHOUT PERMISSION

Prepared by : Xenia

Designed by : Phillip

Checked by : Mike

Approved by : Herbert

TITLE : WiFi Dual Band Ceramic Chip Antenna (AA077) with Evaluation Board Engineering Specification

DOCUMENT NO.

H2B1PG1A1C0200

REV.
A

5-2-3. Return Loss & VSWR

Return Loss (S₁₁)

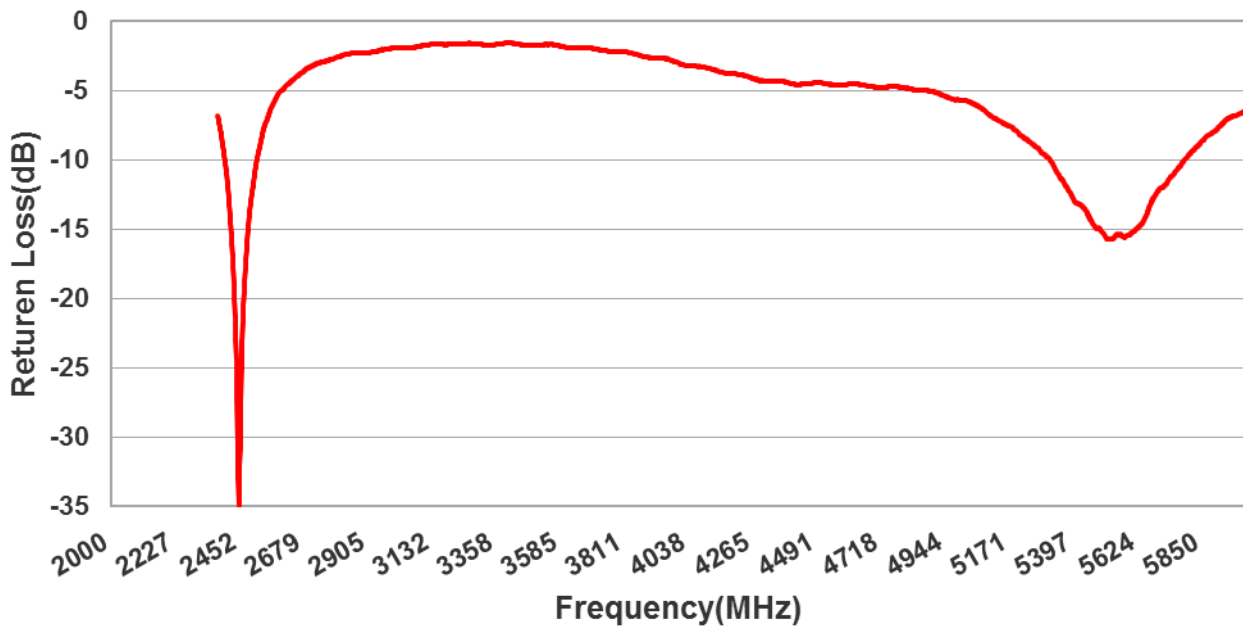

VSWR

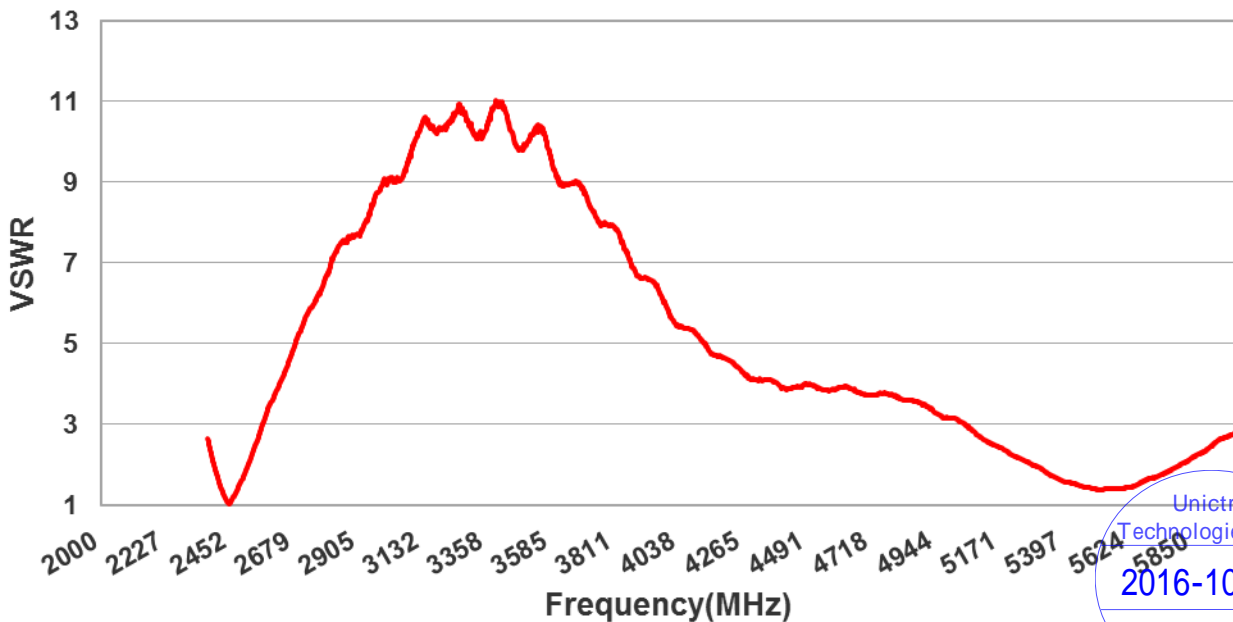

Unictron Technologies Corp.
2016-10-20
Document Control Center



詠業科技股份有限公司
Unictron Technologies Corporation
Website: www.unictron.com

THIS DRAWINGS AND SPECIFICATIONS ARE THE PROPERTY OF UNICTRON TECHNOLOGIES CORPORATION AND SHALL NOT BE REPRODUCED OR USED AS THE BASIS FOR THE MANUFACTURE OR SALE OF APPARATUS OR DEVICES WITHOUT PERMISSION

Prepared by : Xenia

Designed by : Phillip

Checked by : Mike

Approved by : Herbert

TITLE : WiFi Dual Band Ceramic Chip Antenna (AA077) with Evaluation Board Engineering Specification

DOCUMENT NO.

H2B1PG1A1C0200

REV. A

6. Outline Dimensions of Antenna & Evaluation Board (unit: mm)

6-1. Antenna Dimensions

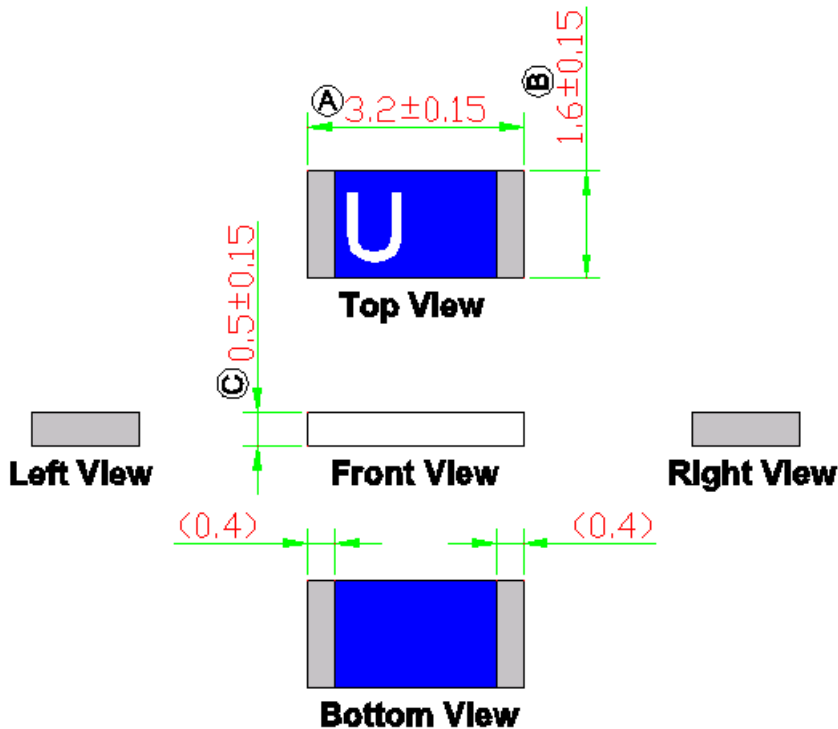

NOTE:

1. All materials are RoHS compliant.
2. "A~C" Critical Dimensions.
3. "()" Reference Dimensions.

PIN Definitions



PIN	1	2
Soldering PAD	Signal	Tuning / Ground



詠業科技股份有限公司
 Unictron Technologies Corporation
 Website: www.unictron.com

THIS DRAWINGS AND SPECIFICATIONS ARE THE PROPERTY OF UNICTRON TECHNOLOGIES CORPORATION AND SHALL NOT BE REPRODUCED OR USED AS THE BASIS FOR THE MANUFACTURE OR SALE OF APPARATUS OR DEVICES WITHOUT PERMISSION

Prepared by : Xenia

Designed by : Phillip

Checked by : Mike

Approved by : Herbert

TITLE : WiFi Dual Band Ceramic Chip Antenna (AA077) with Evaluation Board Engineering Specification

DOCUMENT NO.

H2B1PG1A1C0200

REV.
A

6-2. Evaluation Board with Antenna

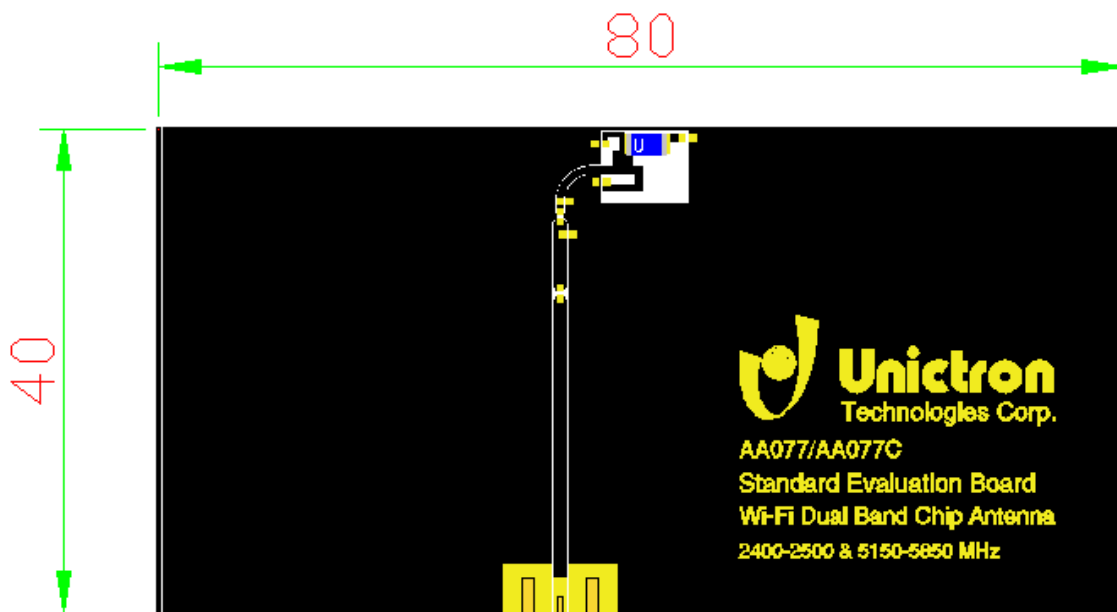

SMA female
1/4"-36UNS-2A

unit : mm



詠業科技股份有限公司
Unictron Technologies Corporation
Website: www.unictron.com

THIS DRAWINGS AND SPECIFICATIONS ARE THE PROPERTY OF UNICTRON TECHNOLOGIES CORPORATION AND SHALL NOT BE REPRODUCED OR USED AS THE BASIS FOR THE MANUFACTURE OR SALE OF APPARATUS OR DEVICES WITHOUT PERMISSION

Prepared by : Xenia

Designed by : Phillip

Checked by : Mike

Approved by : Herbert

TITLE : WiFi Dual Band Ceramic Chip Antenna (AA077) with Evaluation Board Engineering Specification

DOCUMENT NO.

H2B1PG1A1C0200

REV.
A

7. Radiation Pattern (with 80 x 40 mm² Evaluation Board)

7-1. 2400~2500 MHz Band

7-1-1. 3D Gain Pattern @ 2442 MHz (unit: dBi)

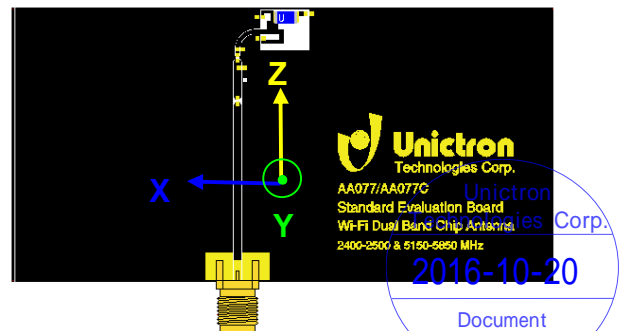
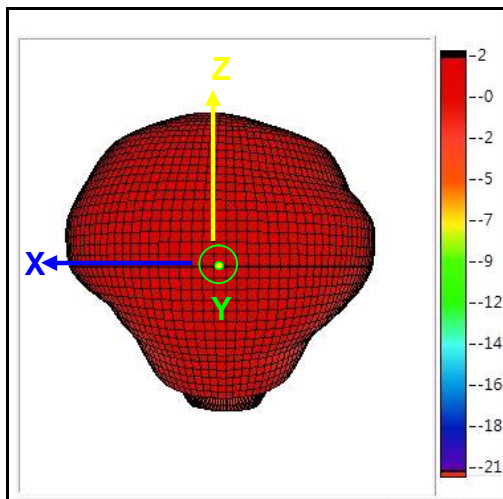
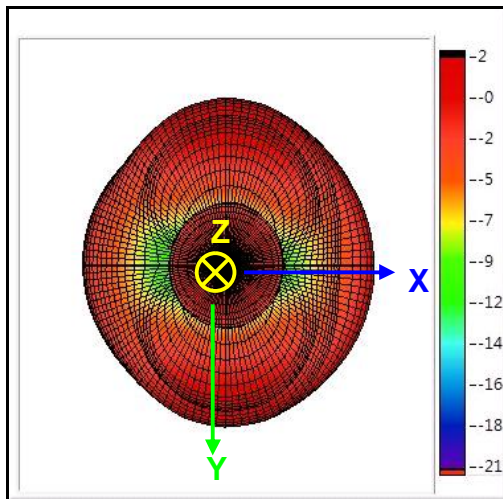
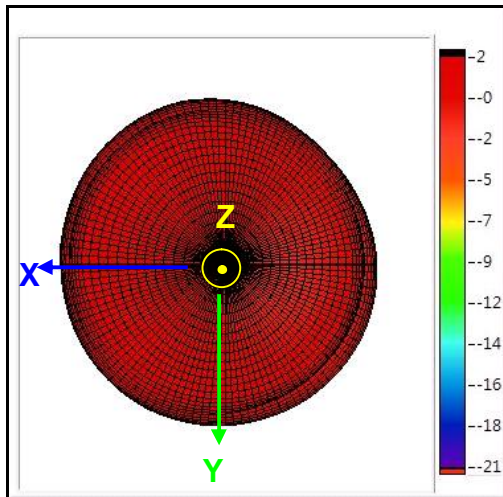

詠業科技股份有限公司
Unictron Technologies Corporation
Website: www.unictron.com

THIS DRAWINGS AND SPECIFICATIONS ARE THE PROPERTY OF UNICTRON TECHNOLOGIES CORPORATION AND SHALL NOT BE REPRODUCED OR USED AS THE BASIS FOR THE MANUFACTURE OR SALE OF APPARATUS OR DEVICES WITHOUT PERMISSION

Prepared by : Xenia

Designed by : Phillip

Checked by : Mike

Approved by : Herbert

TITLE : WiFi Dual Band Ceramic Chip Antenna (AA077) with Evaluation Board Engineering Specification

DOCUMENT NO.

H2B1PG1A1C0200

REV.
A

7-2. 5150~5850 MHz Band

7-2-1. 3D Gain Pattern @ 5150 MHz (unit: dBi)

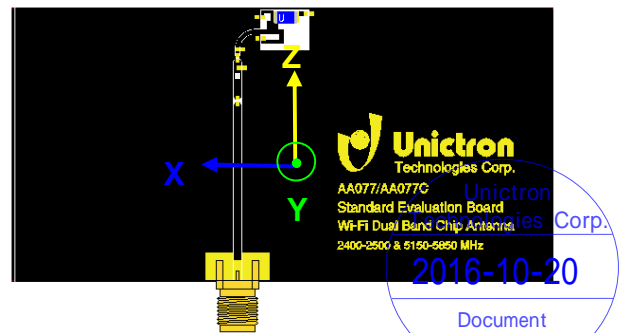
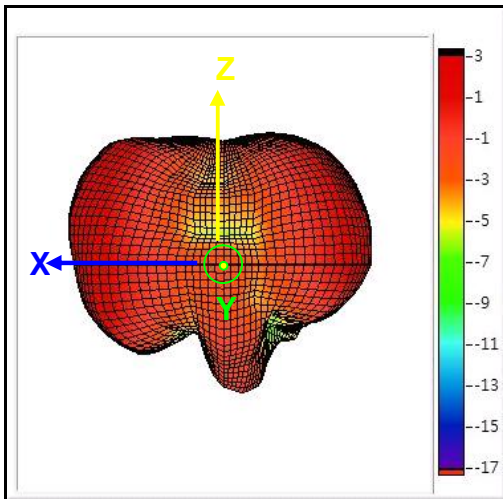
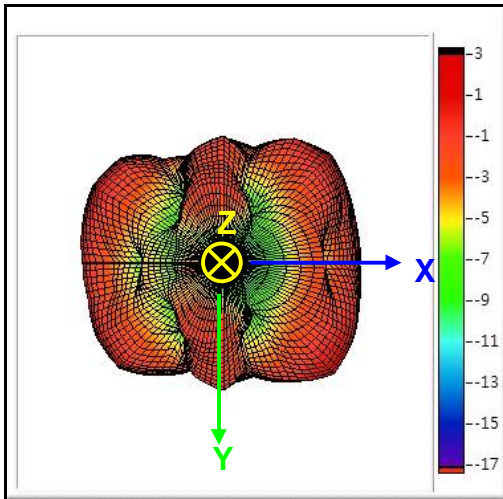
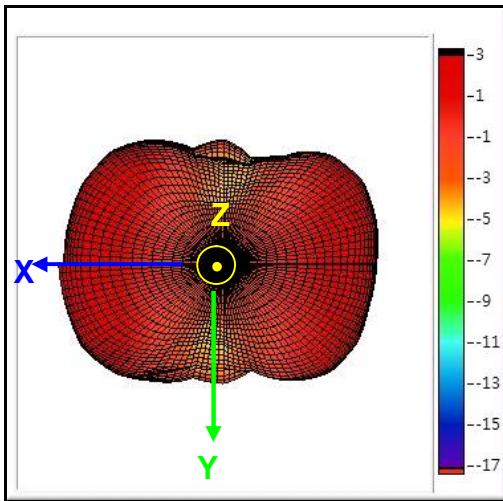

詠業科技股份有限公司
Unicon Technologies Corporation
Website: www.unicon.com

THIS DRAWINGS AND SPECIFICATIONS ARE THE PROPERTY OF UNICTRON TECHNOLOGIES CORPORATION AND SHALL NOT BE REPRODUCED OR USED AS THE BASIS FOR THE MANUFACTURE OR SALE OF APPARATUS OR DEVICES WITHOUT PERMISSION

Prepared by : Xenia

Designed by : Phillip

Checked by : Mike

Approved by : Herbert

TITLE : WiFi Dual Band Ceramic Chip Antenna (AA077) with Evaluation Board Engineering Specification

DOCUMENT NO.

H2B1PG1A1C0200

REV.

A

7-2-2. 3D Gain Pattern @ 5550 MHz (unit: dBi)

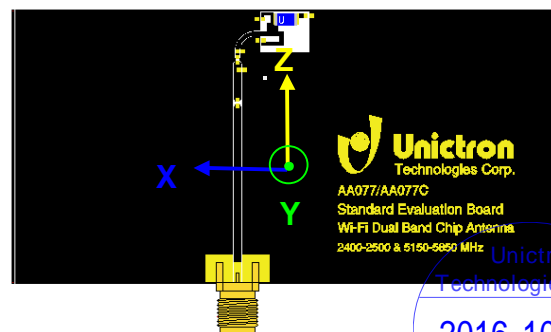
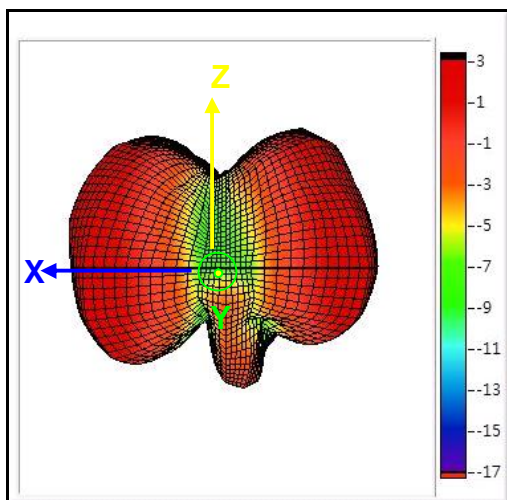
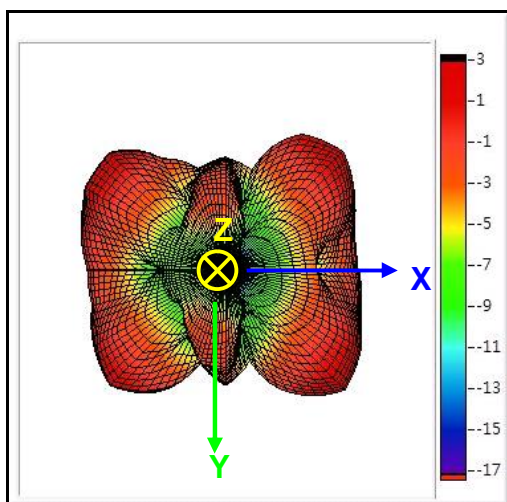
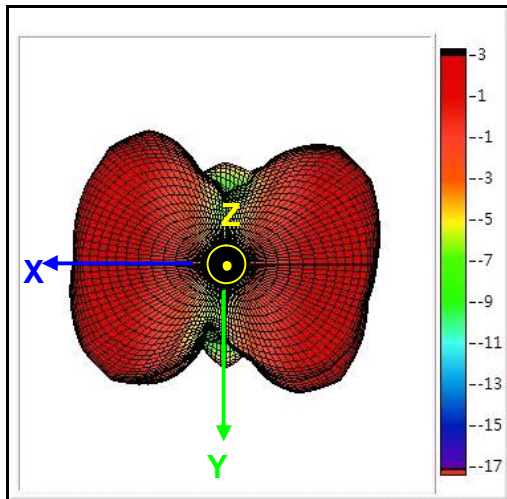

Unictron Technologies Corp.
2016-10-20
Document Control Center



詠業科技股份有限公司
Unictron Technologies Corporation
Website: www.unictron.com

THIS DRAWINGS AND SPECIFICATIONS ARE THE PROPERTY OF UNICTRON TECHNOLOGIES CORPORATION AND SHALL NOT BE REPRODUCED OR USED AS THE BASIS FOR THE MANUFACTURE OR SALE OF APPARATUS OR DEVICES WITHOUT PERMISSION

Prepared by : Xenia

Designed by : Phillip

Checked by : Mike

Approved by : Herbert

TITLE : WiFi Dual Band Ceramic Chip Antenna (AA077) with Evaluation Board Engineering Specification

DOCUMENT NO.

H2B1PG1A1C0200

REV.
A

7-2-3. 3D Gain Pattern @ 5850 MHz (unit: dBi)

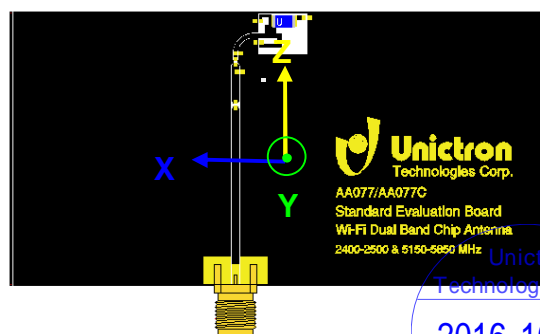
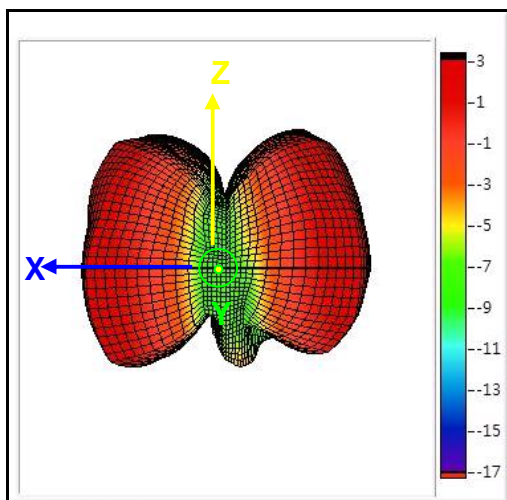
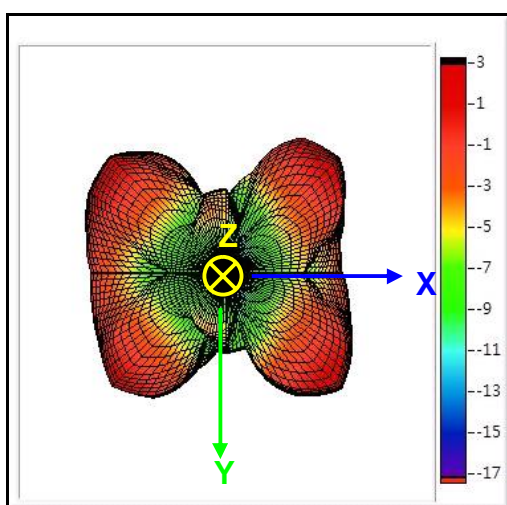
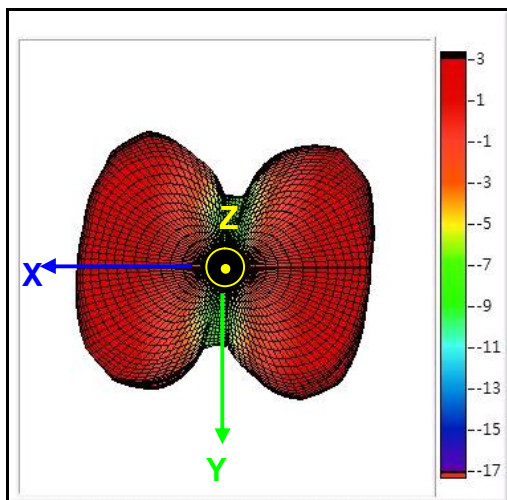

Unictron Technologies Corp.
2016-10-20
Document Control Center



詠業科技股份有限公司
Unictron Technologies Corporation
Website: www.unictron.com

THIS DRAWINGS AND SPECIFICATIONS ARE THE PROPERTY OF UNICTRON TECHNOLOGIES CORPORATION AND SHALL NOT BE REPRODUCED OR USED AS THE BASIS FOR THE MANUFACTURE OR SALE OF APPARATUS OR DEVICES WITHOUT PERMISSION

Prepared by : Xenia

Designed by : Phillip

Checked by : Mike

Approved by : Herbert

TITLE : WiFi Dual Band Ceramic Chip Antenna (AA077) with Evaluation Board Engineering Specification

DOCUMENT NO.

H2B1PG1A1C0200

REV.
A

7-3. 3D Efficiency Table

Frequency(MHz)	2400	2412	2417	2422	2427	2432	2437	2442	2447	2452	2457	2462	2467	2472	2484	2500
Efficiency(dB)	-1.7	-1.4	-1.2	-1.0	-1.0	-1.0	-1.1	-1.1	-1.2	-1.1	-1.1	-1.0	-1.0	-1.1	-1.5	-1.8
Efficiency(%)	67.9	73.2	76.1	78.7	79.9	78.8	77.4	76.8	76.8	77.2	78.1	79.3	79.2	78.1	71.5	65.5
Peak Gain(dBi)	0.8	1.2	1.3	1.4	1.4	1.3	1.3	1.4	1.5	1.5	1.4	1.5	1.4	1.3	1.2	0.8

Frequency(MHz)	5150	5200	5250	5300	5350	5400	5450	5500	5550	5600	5650	5700	5750	5800	5850
Efficiency(dB)	-1.5	-1.4	-1.8	-1.5	-1.4	-1.8	-2.0	-1.6	-1.7	-1.6	-1.4	-1.6	-1.8	-1.5	-1.9
Efficiency(%)	71.5	71.9	65.7	71.6	71.9	65.8	63.2	69.9	67.3	69.6	71.7	68.9	66.6	70.1	64.6
Peak Gain(dBi)	2.2	2.3	2.0	2.3	2.1	2.1	2.0	2.4	2.3	2.8	2.9	2.6	2.5	2.6	2.2

7-4. 3D Efficiency vs. Frequency

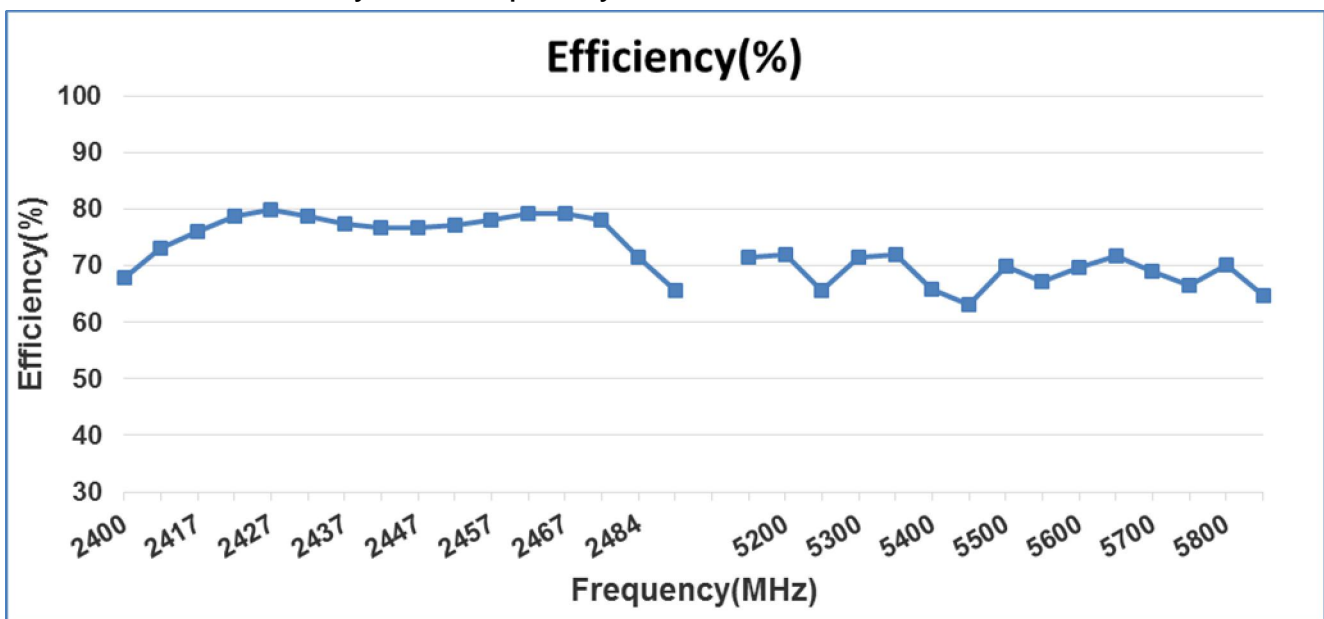

Unictron
Technologies Corp.
2016-10-20
Document
Control Center



詠業科技股份有限公司
Unictron Technologies Corporation
Website: www.unictron.com

THIS DRAWINGS AND SPECIFICATIONS ARE THE PROPERTY OF UNICTRON TECHNOLOGIES CORPORATION AND SHALL NOT BE REPRODUCED OR USED AS THE BASIS FOR THE MANUFACTURE OR SALE OF APPARATUS OR DEVICES WITHOUT PERMISSION

Prepared by : **Xenia**

Designed by : **Phillip**

Checked by : **Mike**

Approved by : **Herbert**

TITLE : WiFi Dual Band Ceramic Chip Antenna (AA077) with Evaluation Board Engineering Specification

DOCUMENT NO.

H2B1PG1A1C0200

REV. A

8. Frequency tuning and Matching circuit

8-1. Chip antenna tuning scenario :

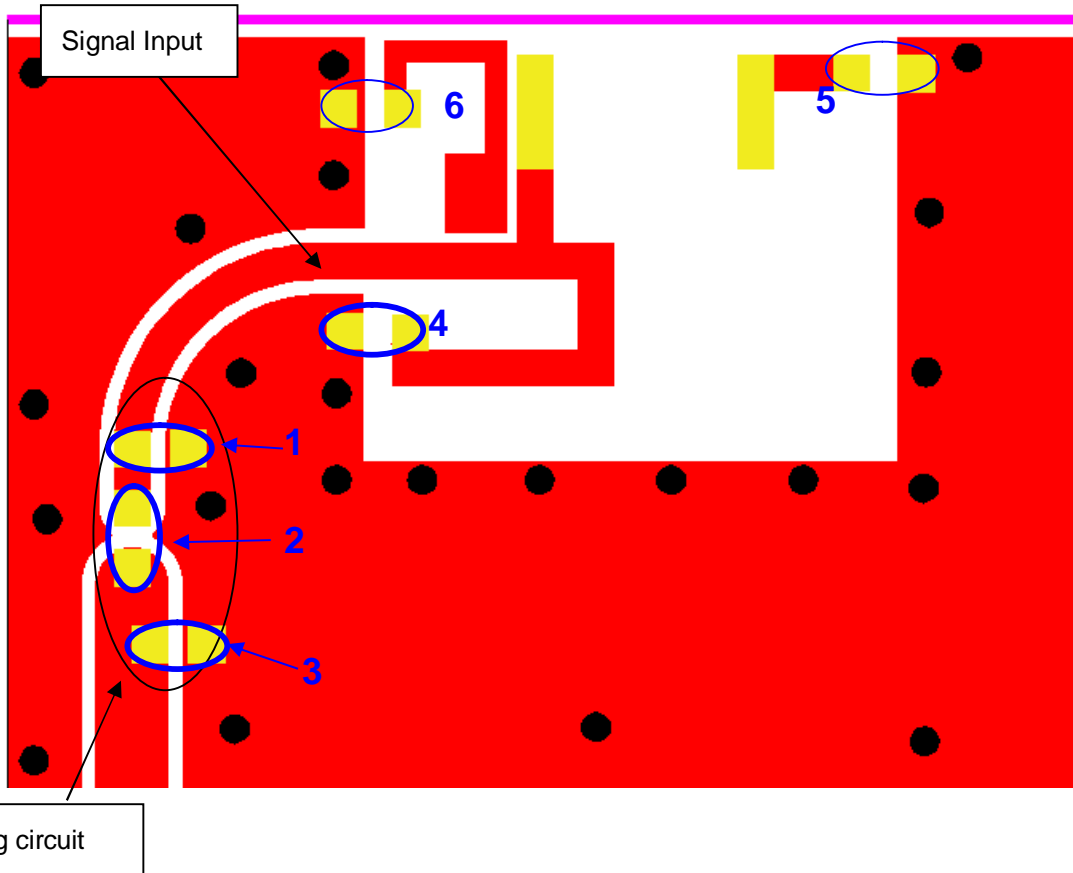

詠業科技股份有限公司
Unictron Technologies Corporation
Website: www.unictron.com

THIS DRAWINGS AND SPECIFICATIONS ARE THE PROPERTY OF UNICTRON TECHNOLOGIES CORPORATION AND SHALL NOT BE REPRODUCED OR USED AS THE BASIS FOR THE MANUFACTURE OR SALE OF APPARATUS OR DEVICES WITHOUT PERMISSION

Prepared by : Xenia

Designed by : Phillip

Checked by : Mike

Approved by : Herbert

TITLE : WiFi Dual Band Ceramic Chip Antenna (AA077) with Evaluation Board Engineering Specification

DOCUMENT NO.

H2B1PG1A1C0200

REV.
A

8-2. Matching circuit :

With the following recommended values of matching and tuning components, the center frequencies will be about 2442 MHz for lower band & 5500 MHz for higher band at our standard 80x40 mm² evaluation board. However, these are typical reference values which may need to be changed when circuit boards or part vendors are different.

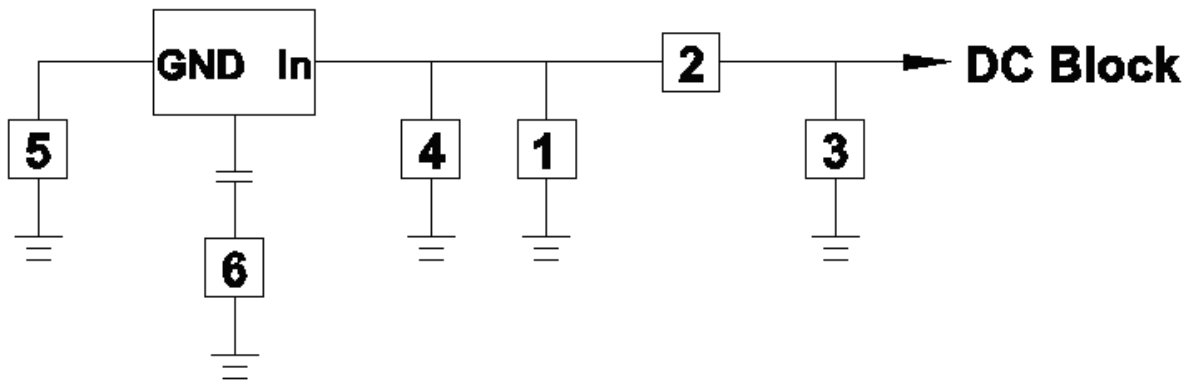

System Matching Circuit Component			
Location	Description	Vendor	Tolerance
1	N/A	-	-
2	1 nH, (0402)	MURATA	±0.1 nH
3	0.2 pF, (0402)	MURATA	±0.05 pF
4	22 pF, (0402)	MURATA	±2%
5 Fine tuning element	1 pF, (0402)	MURATA	±0.05 pF
6 Fine tuning element	0.3 pF, (0201)	MURATA	±0.05 pF



詠業科技股份有限公司
Unictron Technologies Corporation
Website: www.unictron.com

THIS DRAWINGS AND SPECIFICATIONS ARE THE PROPERTY OF UNICTRON TECHNOLOGIES CORPORATION AND SHALL NOT BE REPRODUCED OR USED AS THE BASIS FOR THE MANUFACTURE OR SALE OF APPARATUS OR DEVICES WITHOUT PERMISSION

Prepared by : Xenia

Designed by : Phillip

Checked by : Mike

Approved by : Herbert

TITLE : WiFi Dual Band Ceramic Chip Antenna (AA077) with
Evaluation Board Engineering Specification

DOCUMENT
NO.

H2B1PG1A1C0200

REV.
A

8-3. Reference for frequency tuning element (2400~2500 MHz Band)

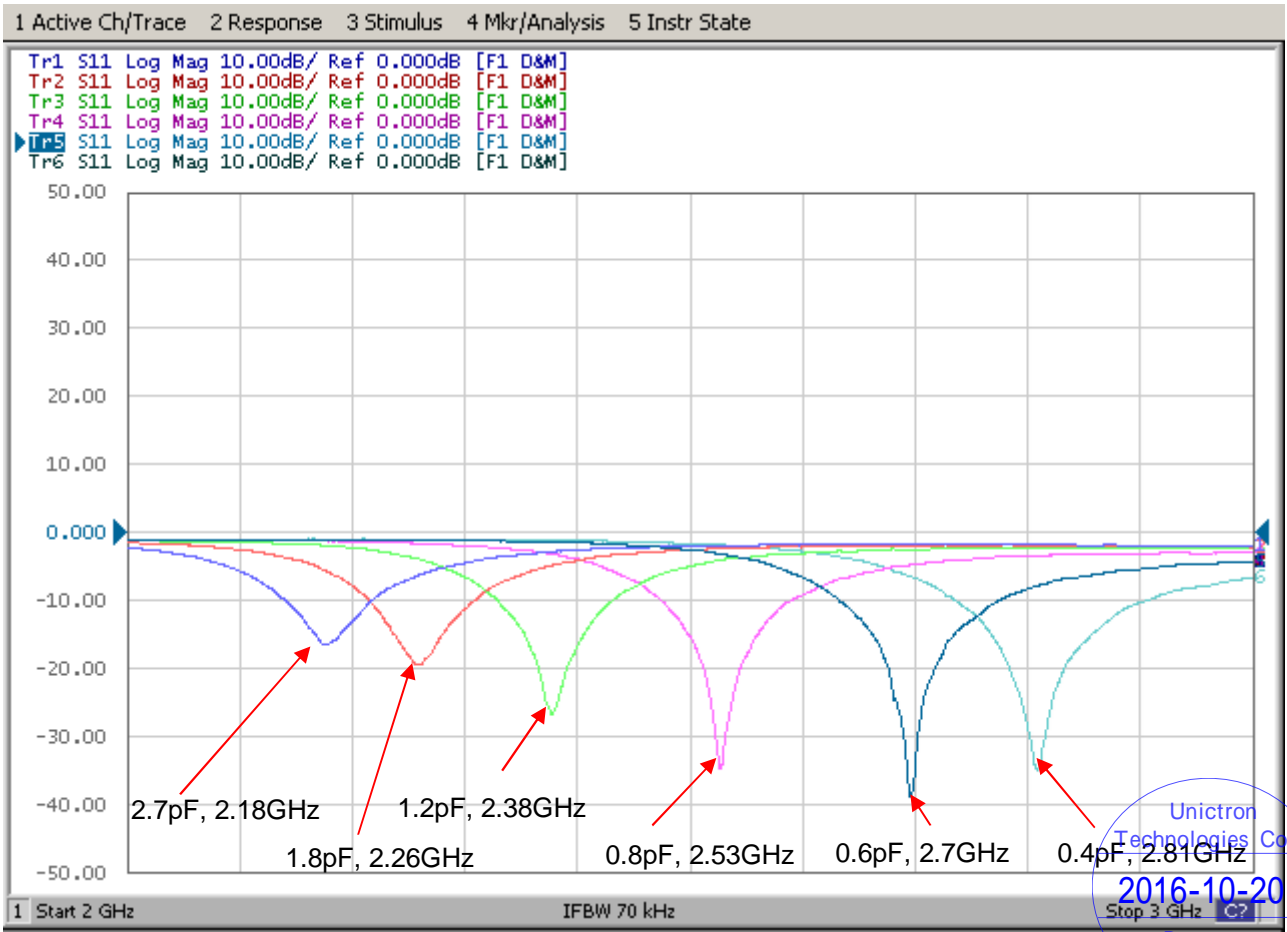
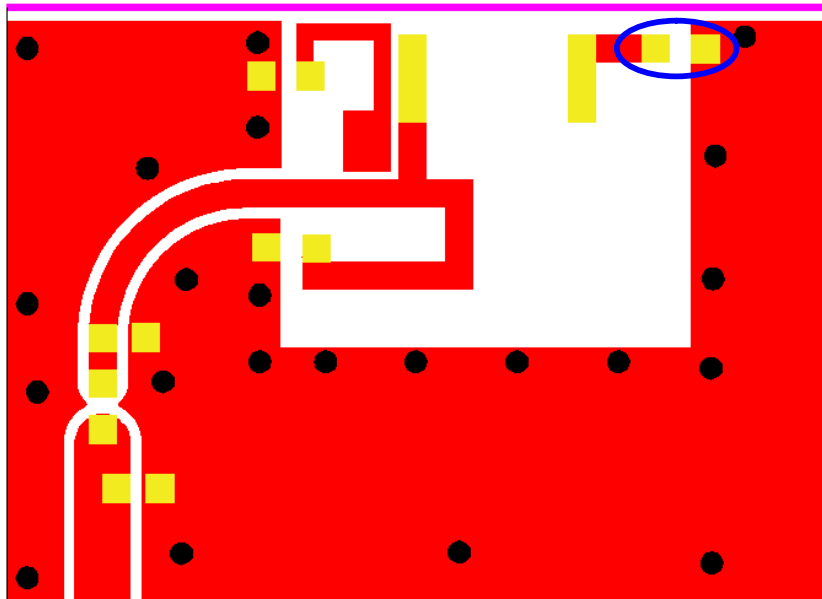

詠業科技股份有限公司
Unictron Technologies Corporation
Website: www.unictron.com

THIS DRAWINGS AND SPECIFICATIONS ARE THE PROPERTY OF UNICTRON TECHNOLOGIES CORPORATION AND SHALL NOT BE REPRODUCED OR USED AS THE BASIS FOR THE MANUFACTURE OR SALE OF APPARATUS OR DEVICES WITHOUT PERMISSION

Prepared by : Xenia

Designed by : Phillip

Checked by : Mike

Approved by : Herbert

TITLE : WiFi Dual Band Ceramic Chip Antenna (AA077) with Evaluation Board Engineering Specification

DOCUMENT NO.

H2B1PG1A1C0200

REV. A

8-4. Reference for frequency tuning element (5150~5850 MHz Band)

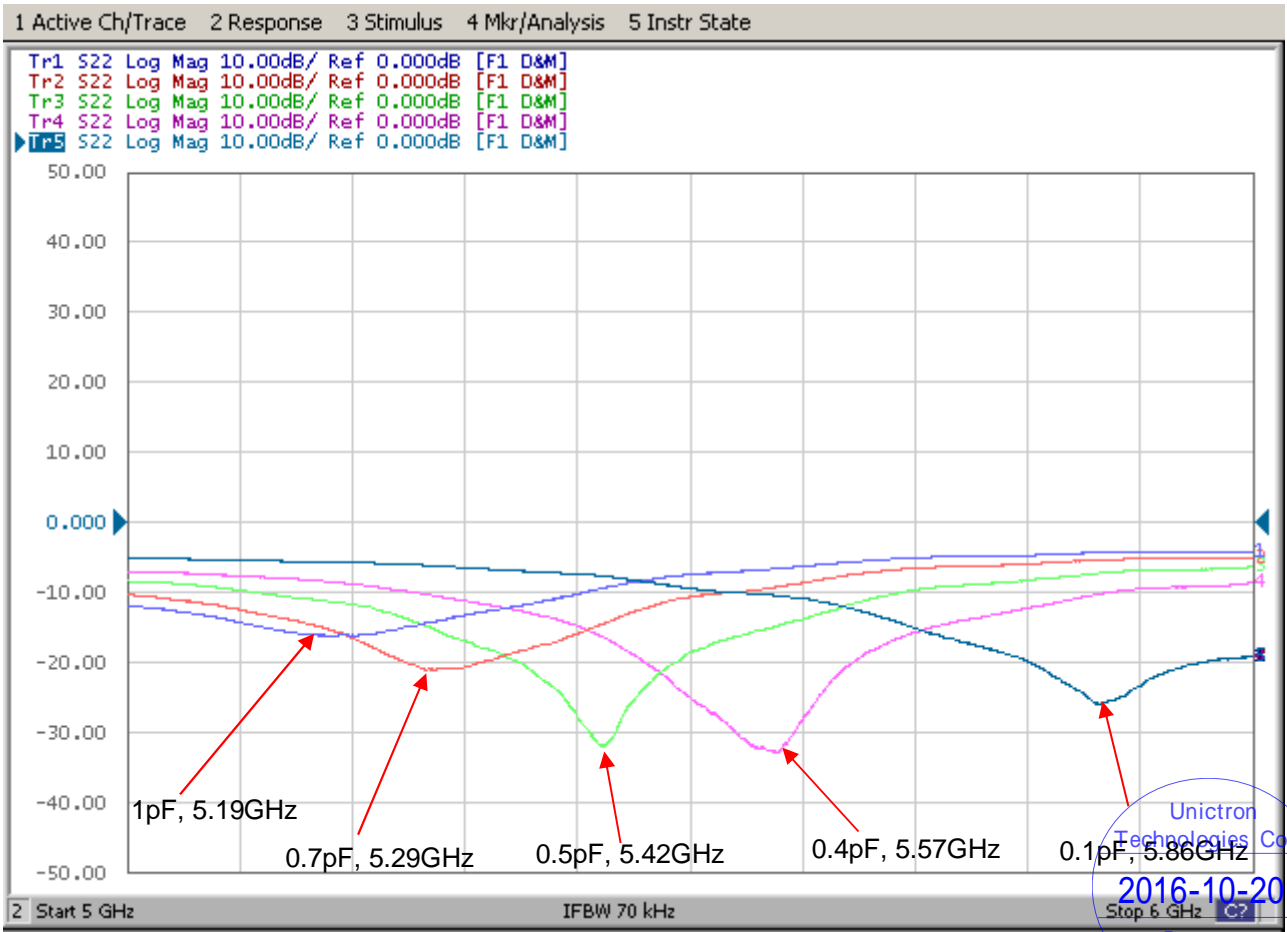
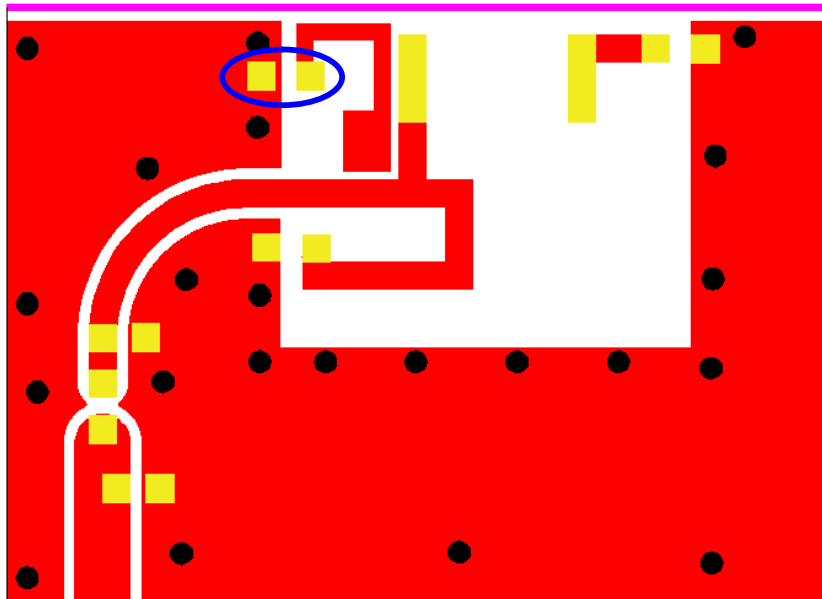

詠業科技股份有限公司
Unictron Technologies Corporation
Website: www.unictron.com

THIS DRAWINGS AND SPECIFICATIONS ARE THE PROPERTY OF UNICTRON TECHNOLOGIES CORPORATION AND SHALL NOT BE REPRODUCED OR USED AS THE BASIS FOR THE MANUFACTURE OR SALE OF APPARATUS OR DEVICES WITHOUT PERMISSION

Prepared by : Xenia

Designed by : Phillip

Checked by : Mike

Approved by : Herbert

TITLE : WiFi Dual Band Ceramic Chip Antenna (AA077) with Evaluation Board Engineering Specification

DOCUMENT NO.

H2B1PG1A1C0200

REV. A

9. Reminders for users of Unictron's AA077 ceramic chip antennas

- 9-1. This chip antenna is made of ceramic materials which are relatively more rigid and brittle compared to printed circuit board materials. Bending of circuit board at the locations where chip antenna is mounted may cause the cracking of solder joints or antenna itself.
- 9-2. Punching/cutting of the break-off tab of PCB panel may cause severe bending of the circuit board which may result in cracking of solder joints or chip antenna itself. Therefore break-off tab shall be located away from the installation site of chip antenna.
- 9-3. Be cautious when ultrasonic welding process needs to be used near the locations where chip antennas are installed. Strong ultrasonic vibration may cause the cracking of chip antenna solder joints.

10. Operating & Storage Conditions

10-1. Operating

- (1) Maximum Input Power: 2 W
- (2) Operating Temperature: -40°C to 85°C

10-2. Storage

- (1) Storage Temperature: -5°C to 40°C
- (2) Relative Humidity: 20% to 70%
- (3) Shelf Life: 1 year

11. Notice

All specifications are subject to change without notice.



詠業科技股份有限公司
Unictron Technologies Corporation
Website: www.unictron.com

THIS DRAWINGS AND SPECIFICATIONS ARE THE PROPERTY OF UNICTRON TECHNOLOGIES CORPORATION AND SHALL NOT BE REPRODUCED OR USED AS THE BASIS FOR THE MANUFACTURE OR SALE OF APPARATUS OR DEVICES WITHOUT PERMISSION

Prepared by : **Xenia**

Designed by : **Phillip**

Checked by : **Mike**

Approved by : **Herbert**

TITLE : WiFi Dual Band Ceramic Chip Antenna (AA077) with Evaluation Board Engineering Specification

DOCUMENT NO.

H2B1PG1A1C0200

REV.
A