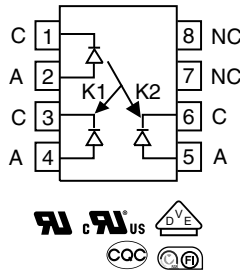
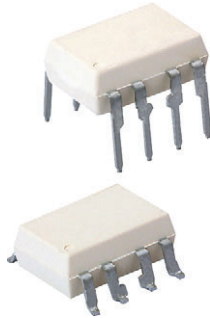


Linear Optocoupler, High Gain Stability, Wide Bandwidth



FEATURES

- Couples AC and DC signals
- High gain stability, $\pm 0.005\%$ /°C typically
- Low input-output capacitance
- Isolation rated voltage 4420 V_{RMS}
- Internal insulation distance, > 0.4 mm
- Material categorization:
for definitions of compliance please see www.vishay.com/doc?99912



LINKS TO ADDITIONAL RESOURCES



DESCRIPTION

The IL300 linear optocoupler consists of an AlGaAs infrared emitter irradiating an output PIN photodiode and a feedback photodiode. The feedback photodiode captures a percentage of the emitter's flux and generates a control signal (I_{P1}) that can be used to keep the emitter output constant by adjusting the emitter forward current. This compensates for the emitter's non-linear, time, and temperature characteristics. The output PIN photodiode produces an output signal (I_{P2}) that is linearly related to the servo optical flux created by the emitter.

The time and temperature stability of the input-output coupler gain ($K3$) is insured by using matched PIN photodiodes that accurately track the output flux of the emitter.

APPLICATIONS

- Power supply feedback voltage / current
- Medical sensor isolation
- Audio signal interfacing
- Isolated process control transducers
- Digital telephone isolation

AGENCY APPROVALS

- [UL / cUL](#) 1577
- [DIN EN 60747-5-5 \(VDE 0884-5\)](#), available with [option 1](#)
- [BSI](#)
- [FIMKO](#)
- [CQC](#)

ORDERING INFORMATION																																					
<table border="1" style="width: 100%; border-collapse: collapse;"> <tr> <td style="text-align: center;">I</td><td style="text-align: center;">L</td><td style="text-align: center;">3</td><td style="text-align: center;">0</td><td style="text-align: center;">0</td><td style="text-align: center;">-</td><td style="text-align: center;">D</td><td style="text-align: center;">E</td><td style="text-align: center;">F</td><td style="text-align: center;">G</td><td style="text-align: center;">-</td><td style="text-align: center;">X</td><td style="text-align: center;">0</td><td style="text-align: center;">#</td><td style="text-align: center;">#</td><td style="text-align: center;">T</td> </tr> <tr> <td colspan="6" style="text-align: center;">PART NUMBER</td> <td colspan="4" style="text-align: center;">K3 BIN</td> <td colspan="3" style="text-align: center;">PACKAGE OPTION</td> <td colspan="2" style="text-align: center;">TAPE AND REEL</td> </tr> </table>	I	L	3	0	0	-	D	E	F	G	-	X	0	#	#	T	PART NUMBER						K3 BIN				PACKAGE OPTION			TAPE AND REEL							
I	L	3	0	0	-	D	E	F	G	-	X	0	#	#	T																						
PART NUMBER						K3 BIN				PACKAGE OPTION			TAPE AND REEL																								
AGENCY CERTIFIED / PACKAGE	K3 BIN																																				
UL, cUL, BSI, FIMKO, CQC	0.557 to 1.618	0.765 to 1.181	0.851 to 1.061	0.851 to 0.955	0.945 to 1.061																																
DIP-8	IL300	IL300-DEFG	IL300-EF	IL300-E	IL300-F																																
DIP-8, 400 mil, option 6	-	IL300-DEFG-X006	-	IL300-E-X006	-																																
SMD-8, option 7	IL300-X007T ⁽¹⁾	IL300-DEFG-X007T ⁽¹⁾	IL300-EF-X007T ⁽¹⁾	IL300-E-X007T	IL300-F-X007T ⁽¹⁾																																
SMD-8, option 9	IL300-X009T	IL300-DEFG-X009T	IL300-EF-X009T	IL300-E-X009T	IL300-F-X009T ⁽¹⁾																																
UL, cUL, BSI, FIMKO, CQC, VDE (option 1)	0.557 to 1.618	0.765 to 1.181	0.851 to 1.061	0.851 to 0.955	0.945 to 1.061																																
DIP-8	-	IL300-DEFG-X001	-	-	IL300-F-X001																																
DIP-8, 400 mil, option 6	IL300-X016	IL300-DEFG-X016	IL300-EF-X016	-	IL300-F-X016																																
SMD-8, option 7	IL300-X017	IL300-DEFG-X017T ⁽¹⁾	IL300-EF-X017T ⁽¹⁾	-	IL300-F-X017T																																

Note

⁽¹⁾ Also available in tubes, do not put "T" on the end



ABSOLUTE MAXIMUM RATINGS ($T_{amb} = 25\text{ }^{\circ}\text{C}$, unless otherwise specified)				
PARAMETER	TEST CONDITION	SYMBOL	VALUE	UNIT
INPUT				
Power dissipation		P_{diss}	100	mW
Forward current		I_F	60	mA
Surge current (pulse width < 10 μs)		I_{PK}	250	mA
Reverse voltage		V_R	5	V
Junction temperature		T_j	125	$^{\circ}\text{C}$
OUTPUT				
Power dissipation		P_{diss}	50	mW
Reverse voltage		V_R	50	V
Junction temperature		T_j	125	$^{\circ}\text{C}$
COUPLER				
Total package dissipation at 25 $^{\circ}\text{C}$		P_{tot}	150	mW
Storage temperature		T_{stg}	-55 to +150	$^{\circ}\text{C}$
Operating temperature		T_{amb}	-55 to +100	$^{\circ}\text{C}$

Note

- Stresses in excess of the absolute maximum ratings can cause permanent damage to the device. Functional operation of the device is not implied at these or any other conditions in excess of those given in the operational sections of this document. Exposure to absolute maximum ratings for extended periods of the time can adversely affect reliability

ELECTRICAL CHARACTERISTICS ($T_{amb} = 25\text{ }^{\circ}\text{C}$, unless otherwise specified)						
PARAMETER	TEST CONDITION	SYMBOL	MIN.	TYP.	MAX.	UNIT
INPUT (LED EMITTER)						
Forward voltage	$I_F = 10\text{ mA}$	V_F	-	1.4	1.5	V
Reverse current	$V_R = 5\text{ V}$	I_R	-	1	-	μA
Junction capacitance	$V_F = 0\text{ V}$, $f = 1\text{ MHz}$	C_j	-	26	-	pF
OUTPUT						
Dark current	$V_{det} = -15\text{ V}$, $I_F = 0\text{ A}$	I_D	-	1	25	nA
Open circuit voltage	$I_F = 10\text{ mA}$	V_D	-	500	-	mV
Short circuit current	$I_F = 10\text{ mA}$	I_{SC}	-	90	-	μA
Junction capacitance	$V_F = 0\text{ V}$, $f = 1\text{ MHz}$	C_j	-	12	-	pF
COUPLER						
Input-output capacitance	$V_F = 0\text{ V}$, $f = 1\text{ MHz}$		-	1	-	pF
K1, servo gain (I_{P1}/I_F)	$I_F = 10\text{ mA}$, $V_{det} = -15\text{ V}$	K1	0.005	0.009	0.015	
Servo photocurrent ⁽¹⁾⁽²⁾	$I_F = 10\text{ mA}$, $V_{det} = -15\text{ V}$	I_{P1}	-	90	-	μA
K2, forward gain (I_{P2}/I_F)	$I_F = 10\text{ mA}$, $V_{det} = -15\text{ V}$	K2	0.005	0.009	0.015	
Forward current	$I_F = 10\text{ mA}$, $V_{det} = -15\text{ V}$	I_{P2}	-	90	-	μA
K3, transfer gain ($K2/K1$) ⁽¹⁾⁽²⁾	$I_F = 10\text{ mA}$, $V_{det} = -15\text{ V}$	K3	0.56	1	1.65	K2/K1
Transfer gain stability	$I_F = 10\text{ mA}$, $V_{det} = -15\text{ V}$, $T_{amb} = 0\text{ }^{\circ}\text{C}$ to $75\text{ }^{\circ}\text{C}$	$\Delta K3/\Delta T_A$	-	± 0.005	± 0.15	%/ $^{\circ}\text{C}$
Transfer gain linearity	$I_F = 2\text{ mA}$ to 10 mA	$\Delta K3$	-	± 0.25	-	%

ELECTRICAL CHARACTERISTICS ($T_{amb} = 25\text{ }^{\circ}\text{C}$, unless otherwise specified)						
PARAMETER	TEST CONDITION	SYMBOL	MIN.	TYP.	MAX.	UNIT
PHOTOCONDUCTIVE OPERATION						
Frequency response	$I_F = 10\text{ mA}$, $MOD = \pm 4\text{ mA}$, $R_L = 50\text{ }\Omega$	BW (-3 db)	-	1.4	-	MHz
Phase response at 200 kHz	$V_{det} = -15\text{ V}$		-	-45	-	$^{\circ}$

Notes

- Minimum and maximum values were tested requirements. Typical values are characteristics of the device and are the result of engineering evaluation. Typical values are for information only and are not part of the testing requirements
- (1) Bin sorting: K3 (transfer gain) is sorted into bins that are $\pm 6\%$, as follows:
 Bin D = 0.765 to 0.859
 Bin E = 0.851 to 0.955
 Bin F = 0.945 to 1.061
 Bin G = 1.051 to 1.181
 K3 = K2/K1. K3 is tested at $I_F = 10\text{ mA}$, $V_{det} = -15\text{ V}$
- (2) Bin categories: All IL300s are sorted into a K3 bin, indicated by an alpha character that is marked on the part. The bins range from "A" through "J".
 The IL300 is shipped in tubes of 50 each. Each tube contains only one category of K3. The category of the parts in the tube is marked on the tube label as well as on each individual part
- (3) Category options: standard IL300 orders will be shipped from the categories that are available at the time of the order. Any of the ten categories may be shipped. For customers requiring a narrower selection of bins, the bins can be grouped together as follows:
 IL300-DEFG: order this part number to receive categories D, E, F, G only
 IL300-EF: order this part number to receive categories E, F only
 IL300-E: order this part number to receive category E only

SWITCHING CHARACTERISTICS						
PARAMETER	TEST CONDITION	SYMBOL	MIN.	TYP.	MAX.	UNIT
Rise time	$I_F = 10\text{ mA}$, $MOD = +2\text{ mA}$, $R_L = 10\text{ k}\Omega$	t_r	-	0.8	-	μs
Fall time		t_f	-	0.8	-	μs

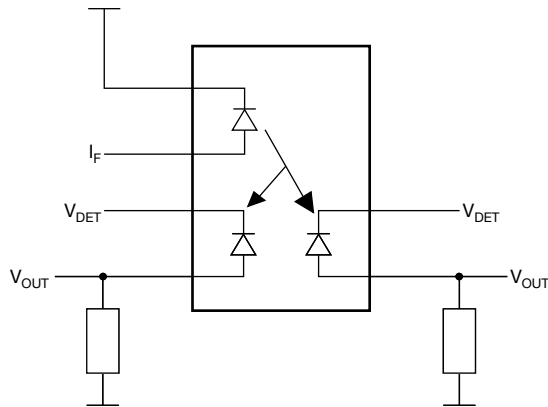


Fig. 1 - Test Circuit

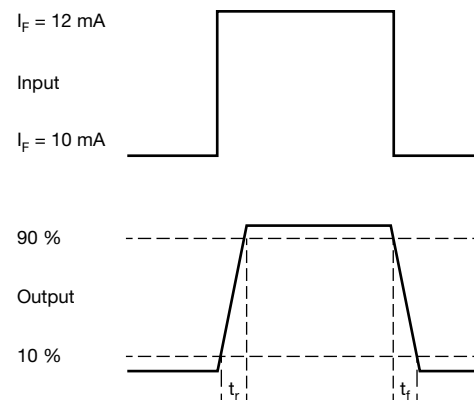


Fig. 2 - Switching Times

COMMON MODE TRANSIENT IMMUNITY						
PARAMETER	TEST CONDITION	SYMBOL	MIN.	TYP.	MAX.	UNIT
Common mode capacitance	$V_F = 0\text{ V}$, $f = 1\text{ MHz}$	C_{CM}	-	1	-	μF
Common mode rejection ratio	$f = 60\text{ Hz}$, $R_L = 2.2\text{ k}\Omega$	CMRR	-	100	-	dB

SAFETY AND INSULATION RATINGS				
PARAMETER	TEST CONDITION	SYMBOL	VALUE	UNIT
Climatic classification	According to IEC 68 part 1		55 / 100 / 21	
Comparative tracking index		CTI	175	
Maximum rated withstanding isolation voltage	t = 1 min	V_{ISO}	4420	V_{RMS}
Maximum transient isolation voltage		V_{IOTM}	10 000	V_{peak}
Maximum repetitive peak isolation voltage		V_{IORM}	890	V_{peak}
Isolation resistance	$V_{IO} = 500\text{ V}, T_{amb} = 25\text{ }^{\circ}\text{C}$	R_{IO}	$\geq 10^{12}$	Ω
	$V_{IO} = 500\text{ V}, T_{amb} = 100\text{ }^{\circ}\text{C}$	R_{IO}	$\geq 10^{11}$	Ω
Output safety power		P_{SO}	400	mW
Input safety current		I_{SI}	275	mA
Safety temperature		T_S	175	$^{\circ}\text{C}$
Creepage distance	DIP-8		≥ 7	mm
Clearance distance			≥ 7	mm
Creepage distance	DIP-8, 400 mil, option 6; SMD-8, option 7; SMD-8, option 9		≥ 8	mm
Clearance distance			≥ 8	mm
Insulation thickness		DTI	≥ 0.4	mm

Note

- As per IEC 60747-5-5, § 7.4.3.8.2, this optocoupler is suitable for “safe electrical insulation” only within the safety ratings. Compliance with the safety ratings shall be ensured by means of protective circuits

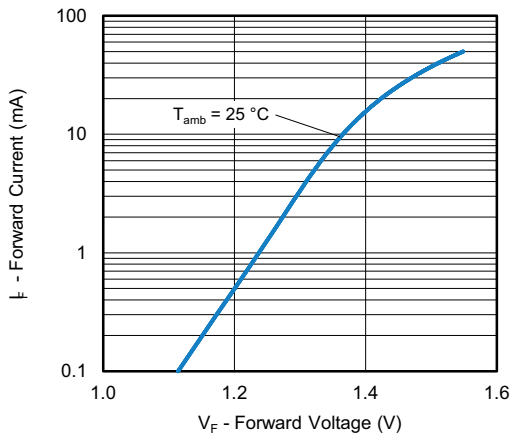
TYPICAL CHARACTERISTICS ($T_{amb} = 25\text{ }^{\circ}\text{C}$, unless otherwise specified)


Fig. 3 - Forward Voltage vs. Forward Current

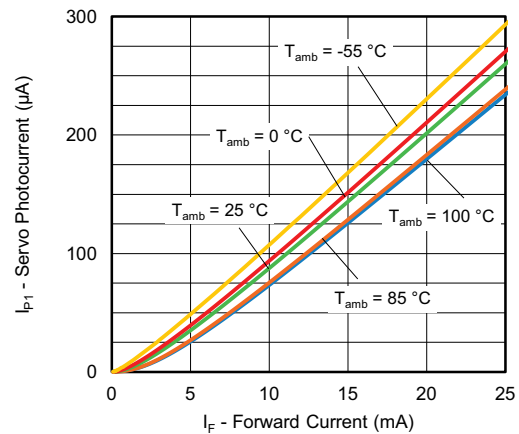


Fig. 4 - Servo Photocurrent vs. Forward Current

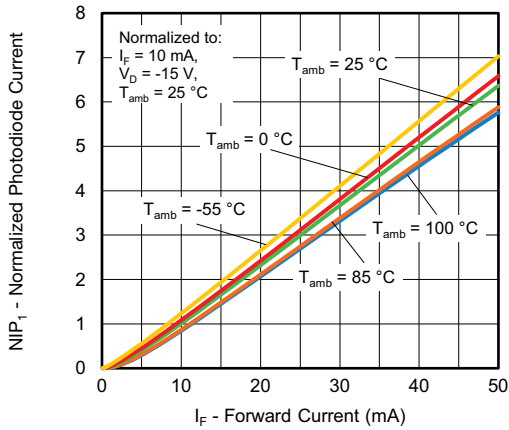


Fig. 5 - Normalized Photodiode Current vs. Forward Current

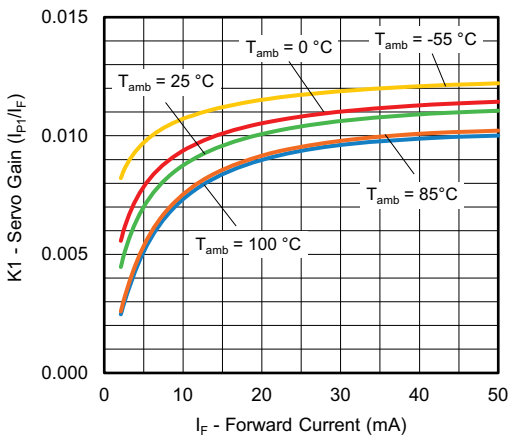


Fig. 6 - Servo Gain vs. Forward Current

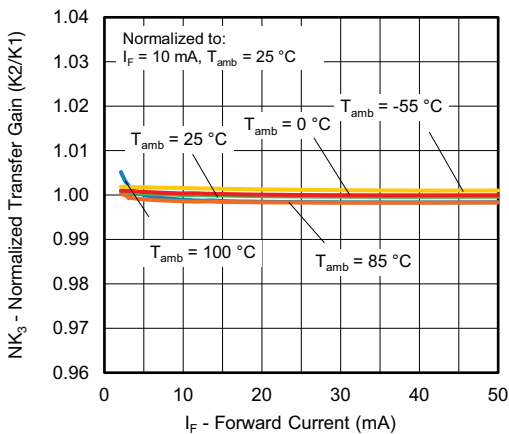
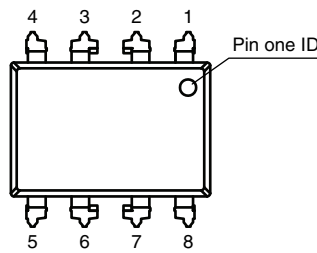
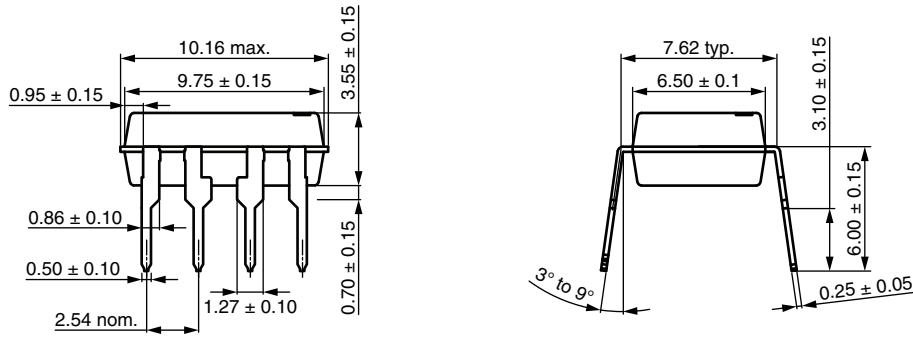
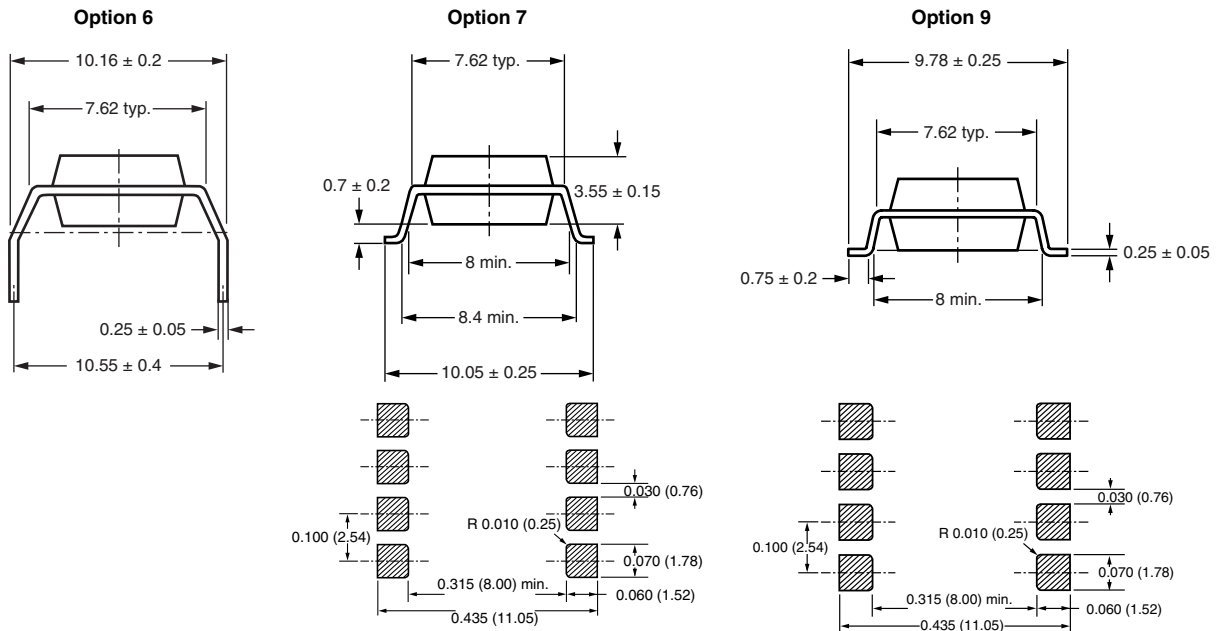


Fig. 7 - Normalized Transfer Gain vs. Forward Current

PACKAGE DIMENSIONS (in millimeters)



hm



PACKAGE MARKING

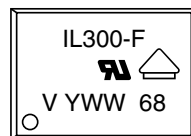


Fig. 8 - Example of IL300-F-X001

SOLDER PROFILES



19841

Fig. 9 - Lead (Pb)-free Reflow Solder Profile According to J-STD-020 for SMD Devices

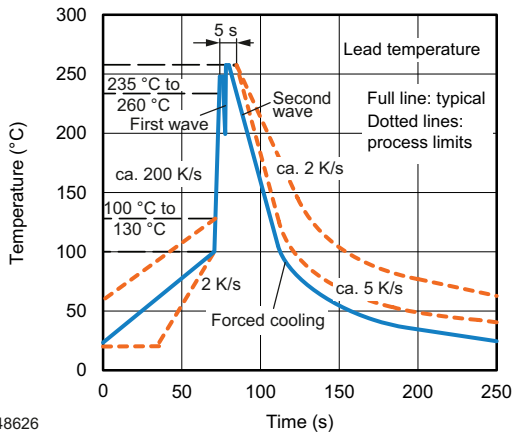
HANDLING AND STORAGE CONDITIONS

ESD level: HBM class 2

Floor life: unlimited

Conditions: $T_{amb} < 30\text{ }^{\circ}\text{C}$, RH < 85 %

Moisture sensitivity level 1, according to J-STD-020



948626

Fig. 10 - Wave Soldering Double Wave Profile According to J-STD-020 for DIP Devices



Disclaimer

ALL PRODUCT, PRODUCT SPECIFICATIONS AND DATA ARE SUBJECT TO CHANGE WITHOUT NOTICE TO IMPROVE RELIABILITY, FUNCTION OR DESIGN OR OTHERWISE.

Vishay Intertechnology, Inc., its affiliates, agents, and employees, and all persons acting on its or their behalf (collectively, "Vishay"), disclaim any and all liability for any errors, inaccuracies or incompleteness contained in any datasheet or in any other disclosure relating to any product.

Vishay makes no warranty, representation or guarantee regarding the suitability of the products for any particular purpose or the continuing production of any product. To the maximum extent permitted by applicable law, Vishay disclaims (i) any and all liability arising out of the application or use of any product, (ii) any and all liability, including without limitation special, consequential or incidental damages, and (iii) any and all implied warranties, including warranties of fitness for particular purpose, non-infringement and merchantability.

Statements regarding the suitability of products for certain types of applications are based on Vishay's knowledge of typical requirements that are often placed on Vishay products in generic applications. Such statements are not binding statements about the suitability of products for a particular application. It is the customer's responsibility to validate that a particular product with the properties described in the product specification is suitable for use in a particular application. Parameters provided in datasheets and / or specifications may vary in different applications and performance may vary over time. All operating parameters, including typical parameters, must be validated for each customer application by the customer's technical experts. Product specifications do not expand or otherwise modify Vishay's terms and conditions of purchase, including but not limited to the warranty expressed therein.

Hyperlinks included in this datasheet may direct users to third-party websites. These links are provided as a convenience and for informational purposes only. Inclusion of these hyperlinks does not constitute an endorsement or an approval by Vishay of any of the products, services or opinions of the corporation, organization or individual associated with the third-party website. Vishay disclaims any and all liability and bears no responsibility for the accuracy, legality or content of the third-party website or for that of subsequent links.

Except as expressly indicated in writing, Vishay products are not designed for use in medical, life-saving, or life-sustaining applications or for any other application in which the failure of the Vishay product could result in personal injury or death. Customers using or selling Vishay products not expressly indicated for use in such applications do so at their own risk. Please contact authorized Vishay personnel to obtain written terms and conditions regarding products designed for such applications.

No license, express or implied, by estoppel or otherwise, to any intellectual property rights is granted by this document or by any conduct of Vishay. Product names and markings noted herein may be trademarks of their respective owners.