

## Technical Information

# Liquipoint T FTW31, FTW32

## Conductive

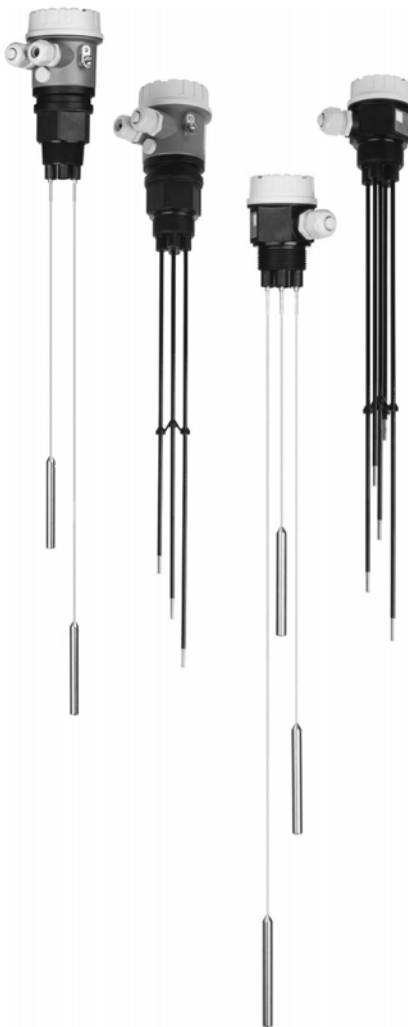

## Point level switch for multiple point detection in conductive liquids

### Applications

The Liquipoint T is used for point level measurement in conductive liquids (from 10  $\mu\text{S}/\text{cm}$ ). Depending on the number of measuring points (up to 5 rods or ropes), measuring tasks such as overflow protection, dry running protection, two-point control of pumps or multiple point detection can be implemented.

### Your benefits

- Detect up to five point levels with one probe
- Two-point control and additional MAX and MIN detection
- Option between rod or rope version for optimum adaptation to the application
- Flexible instrumentation:
  - with built-in electronic insert, either transistor (PNP) or relay output
  - for connection to a separate transmitter power supply unit
- No adjustment required; standard setting for the most common conductive liquids
- No moving parts in the tank:
  - long service life
  - reliable operation with no wear or blockages
- WHG approval
- Easy adaptation to different conductivities

## Table of contents

<b>Function and system design</b> .....	<b>3</b>	<b>Mechanical construction</b> .....	<b>17</b>
Measuring principle .....	3	Weights .....	17
Measuring system .....	3	Material .....	17
		Fitted electrodes .....	18
<b>Input</b> .....	<b>5</b>	<b>Human interface</b> .....	<b>19</b>
Measured variable .....	5	Operating elements .....	19
Measuring range (application) .....	5	Display elements .....	19
Input signal .....	5		
<b>Output</b> .....	<b>5</b>	<b>Certificates and approvals</b> .....	<b>20</b>
Electronic insert FEW52 (DC-PNP) .....	5	CE mark .....	20
Electronic insert FEW54 (relay) .....	6	Overfill protection .....	20
Electronic insert FEW58 (NAMUR) .....	8	Other standards and guidelines .....	20
Cable monitoring .....	8	RoHS .....	20
		RCM-Tick marking .....	20
		Ex-approvals .....	20
		Type of protection .....	20
<b>Power supply</b> .....	<b>9</b>	<b>Ordering information</b> .....	<b>21</b>
Compact instrument version with FEW52 .....	9	Ordering information .....	21
Compact instrument version with FEW54 .....	10		
Compact instrument version with FEW58 .....	11	<b>Accessories</b> .....	<b>21</b>
Separate instrumentation for probes with two rods or ropes with cable monitoring .....	11	Liquipoint T .....	21
Separate instrumentation for probes with three rods or ropes with cable monitoring .....	12		
Separate instrumentation for probes with five rods or ropes with cable monitoring .....	12	<b>Documentation</b> .....	<b>22</b>
Cable entry .....	13	Operating Instructions .....	22
Cable specifications .....	13	Certificates .....	22
<b>Performance characteristics</b> .....	<b>13</b>		
Reference operating conditions .....	13		
Measuring error .....	13		
Non-repeatability .....	13		
Hysteresis .....	13		
Switch-on delay .....	13		
Influence of ambient temperature .....	13		
<b>Installation</b> .....	<b>13</b>		
Mounting location .....	13		
Orientation of probes .....	14		
Example applications .....	14		
<b>Environment</b> .....	<b>15</b>		
Ambient temperature range .....	15		
Storage temperature .....	15		
Climate class .....	15		
Degree of protection .....	15		
Shock resistance .....	15		
Vibration resistance (at min. rod length) .....	15		
Electromagnetic compatibility .....	15		
<b>Process</b> .....	<b>16</b>		
Conductivity .....	16		
Limiting medium pressure range .....	16		
Environment .....	16		

## Function and system design

### Measuring principle

An alternating voltage exists between the probe rods. As soon as a conductive liquid creates a connection between the ground probe rod and, for example, the MAX probe rod, a measurable current flows and the Liquipoint T switches.

With point level detection, the device switches back as soon as the liquid clears the MIN probe.

With two-point control, the device does not switch back until the MAX and MIN probe is cleared.

Using alternating voltage prevents corrosion of the probe rods and electrolytic destruction of the product.

The material used for the tank walls is not relevant for measurement because the system is designed as a closed, potential-free circuit between the probe rods and the electronics.

There is absolutely no danger if the probe rods are touched during operation.

### Measuring system

#### Probes without an integrated electronic insert (separate instrument version) for one- or two-point detection

The measuring system consists of:

- FTW31, FTW32 with two/three rods or ropes
- One or two Nivotester FTW325
- Control units, switches or signal transmitters, e.g. process control systems PLC, relays, etc.

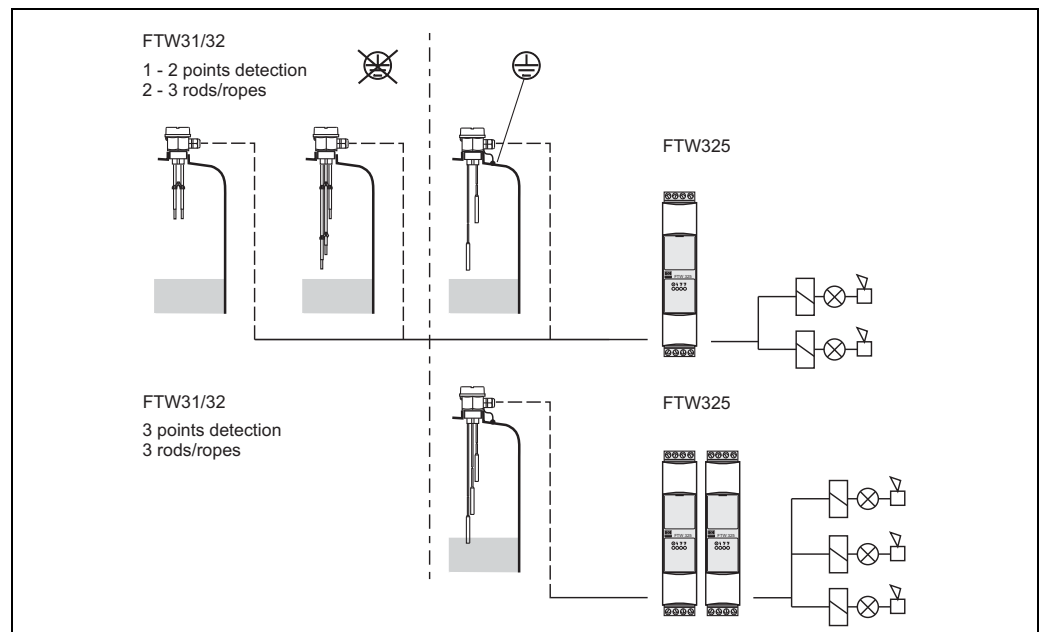

Switch points, depending on the tank material

### Probes without integrated electronic insert for multiple point detection

The measuring system consists of:

- FTW31, FTW32 with five rods or ropes
- Two or three Nivotester FTW325
- Control units, switches or signal transmitters, e.g. process control systems PLC, relays, etc.

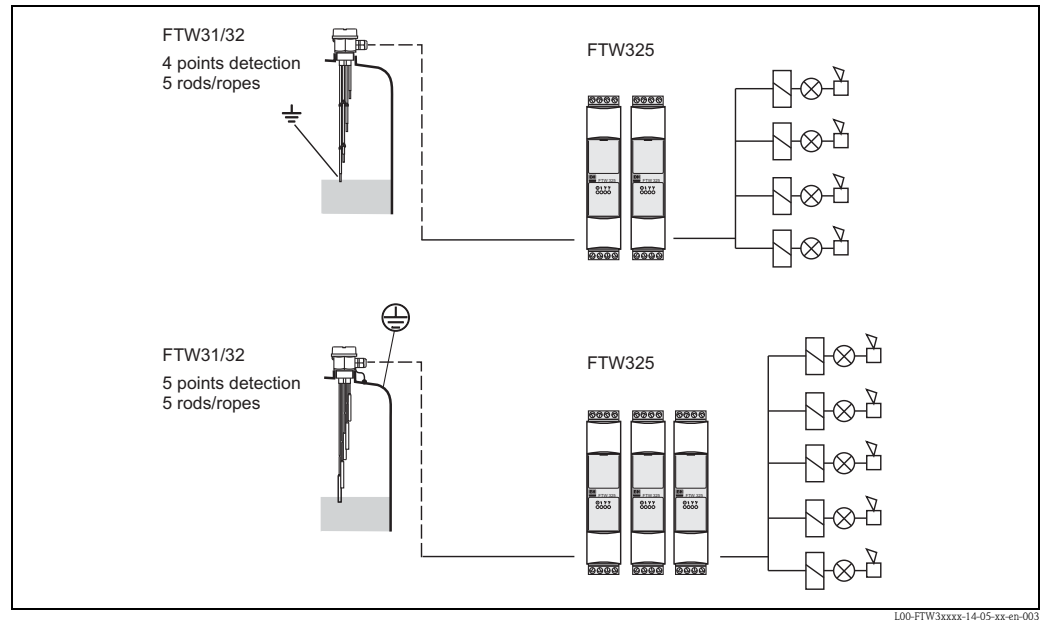

Switch points, depending on the tank material

### Probes with integrated electronic insert (compact instrument version)

The measuring system consists of:

- FTW31 with rods or FTW32 with ropes and an electronic insert
- Control units, switches or signal transmitters, e.g. process control systems PLC, relays, etc.

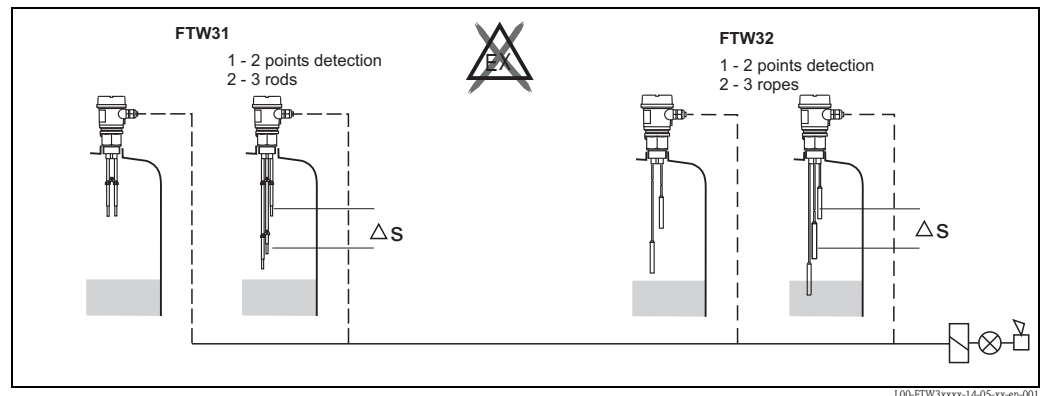

Independent of the tank material



Note!

The compact instrument version with three rods or ropes is always operated in  $\Delta S$  mode.

## Input

<b>Measured variable</b>	Resistance change between two conductors caused by the presence or absence of a conductive liquid.
<b>Measuring range (application)</b>	The measuring range is dependent on the mounting location of the probes. Rod probes can have a max. length of 4 m (13 ft), and rope probes can have a max. length of 15 m (49 ft).
<b>Input signal</b>	Probes covered => a measurable current is flowing between the probes. Probes uncovered => there is no measurable current flowing between the probes.

## Output

### Electronic insert FEW52 (DC-PNP)







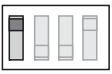
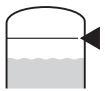

#### Output signal

*Three-wire direct current version*

Preferred in conjunction with programmable logic controllers (PLC).

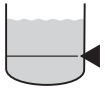
Positive signal at the switch output of the electronics (PNP).

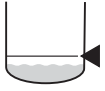
The output is blocked after the point level is reached.

Fail-safe mode	Switch point	Output signal	rd
<b>MAX</b> 		<sup>*1</sup> $L+$ $1 \xrightarrow{I_L} 3$	<sup>*3</sup> 
		<sup>*2</sup> $1 \xrightarrow{< 100 \mu A} 3$	<sup>*4</sup> 
<b>MIN</b> 		$L+$ $1 \xrightarrow{I_L} 3$	
		$+$ $1 \xrightarrow{< 100 \mu A} 3$	

L00-FTW3xxxx-15-05-xx-en-001

<sup>\*1</sup> = Load current (connected); <sup>\*2</sup> Residual current (disconnected); <sup>\*3</sup> LED not lit; <sup>\*4</sup> LED lit  
See also "Output signal" → 5.

If the probe is covered and the red LED flashes continuously, the sensitivity setting is too high. To ensure a safe switch status even if the conductivity of the medium varies slightly, reduce the sensitivity setting.

#### Fail-safe mode

Selecting the correct fail-safe mode ensures that the output always runs in quiescent current fail-safe.

- **MAX fail-safe mode (MAX):** The output voltage is 0 V if the switch point is exceeded (probe covered), a fault occurs or the power supply fails.
- **MIN fail-safe mode (MIN):** The output voltage is 0 V if the switch point is undershot (probe uncovered), a fault occurs or the power supply fails.

#### Switching delay

A switching delay of 2.0 s can be activated or deactivated via a DIL switch.

If the switching delay is set to 0 s, the device switches after approx. 0.3 s.

### Sensitivity

The device operates in one of four sensitivity levels (100 Ω, 1 kΩ, 10 kΩ or 100 kΩ). The sensitivity level is set using two DIL switches (SENS). Setting on delivery: 100 kΩ (maximum sensitivity).

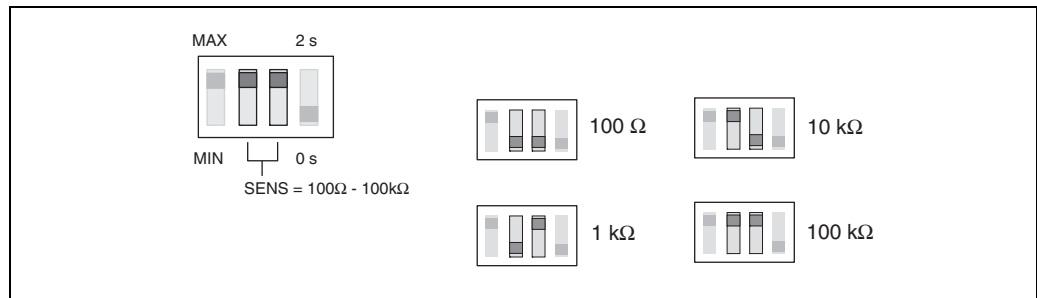

L00-FTW3xxxx-15-05-xx-xx-001

### Signal on alarm

In the event of a power failure or a damaged probe: < 100 μA

### Load

- Load is switched via a transistor (PNP).
- Cycled overload and short-circuit protection, continuous ≤200 mA (short-circuit proof)
- Residual voltage at transistor at  $I_{max}$ : <2.9 V

### Electronic insert FEW54 (relay)

### Output signal

AC/DC connection with relay output

Both relay contacts switch simultaneously.

Fail-safe mode	Switch point	Output signal	rd
MAX 		*1 3 4 5 6 7 8	*3 
		*2 3 4 5 6 7 8	*4 
MIN 		*1 3 4 5 6 7 8	*3 
		*2 3 4 5 6 7 8	*4 

L00-FTW3xxxx-15-05-xx-xx-002

\*1 = Relay energized; \*2 Relay de-energized; \*3 LED not lit; \*4 LED lit  
See also "Power supply" → 9.

If the probe is covered and the red LED flashes continuously, the sensitivity setting is too high. To ensure a safe switch status even if the conductivity of the medium varies slightly, reduce the sensitivity level.

### Fail-safe mode

Selecting the correct fail-safe mode ensures that the relay always runs in quiescent current fail-safe.

- **MAX safety (MAX):** The relay de-energizes when the switch point is exceeded. (probe covered), a fault occurs or the power supply fails.
- **MIN safety (MIN):** The relay de-energizes when the switch point is undershot. (probe uncovered), a fault occurs or the power supply fails.

### Sensitivity

The device operates in one of four sensitivity levels (100 Ω, 1 kΩ, 10 kΩ or 100 kΩ).

The sensitivity level is set using 2 DIL switches (SENS).

Setting on delivery: 100 kΩ (maximum sensitivity)

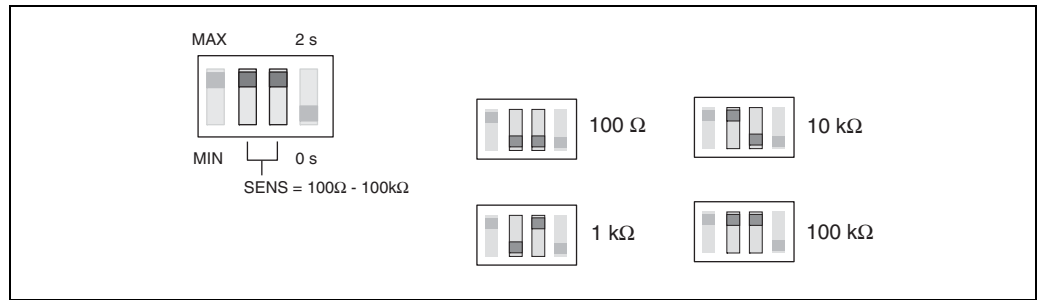

### Switching delay

A switching delay of 2.0 s can be activated or deactivated via a DIL switch.

If the switching delay is set to 0 s, the device switches after approx. 0.3 s.

### Signal on alarm

Output signal in the event of a power failure or a damaged probe: relay de-energized.

### Load

Loads are switched via 2 potential-free change-over contacts.

I~ max. 4 A, U~ max. 253 V;

P~ max. 1000 VA,  $\cos \varphi = 1$ , P~ max. 700 VA,  $\cos \varphi > 0.7$ ;

I- max. 4 A to 30 V, I- max. 0.2 A to 150 V.

When connecting a functional extra-low voltage circuit with double insulation in accordance with IEC 1010: the sum of the relay output and power supply voltages is max. 300 V.

### Galvanic isolation



All input channels, output channels and relay contacts are galvanically isolated from each other.

**Electronic insert FEW58 (NAMUR)**













**Output signal**

For connecting to isolating amplifiers acc. to NAMUR (IEC 60947-5-6) e.g. Nivotester FTL325N from Endress+Hauser.

Output signal jump from high to low current on point level (H-L edge).

-  = lit
-  = flashes
-  = unlit

L00-FTL5xxxx-07-05-xx-xx-002

Fail-safe mode	Level	Output signal	LEDs	
			gn	ye
MAX		2.2 ... 6.5 mA + 2 → 1		
		0.4 ... 1.0 mA + 2 → 1		
MIN		2.2 ... 6.5 mA + 2 → 1		
		0.4 ... 1.0 mA + 2 → 1		

L00-FTW3xxxx-04-05-xx-xx-004

**Fail-safe mode**

Selecting the correct fail-safe mode ensures that the relay always runs in quiescent current fail-safe.

- MAX safety (MAX): The output signal is <1.0 mA when the switch point is exceeded (probe covered), a fault occurs or the power supply fails.
- MIN safety (MIN): The output signal is <1.0 mA when the switch point is undershot (probe uncovered), a fault occurs or the power supply fails.

**Sensitivity**

The device operates in one of four sensitivity levels (100 Ω, 1 kΩ, 10 kΩ or 100 kΩ).

The sensitivity level is set using two DIL switches (SENS).

Setting on delivery: 100 kΩ (maximum sensitivity)

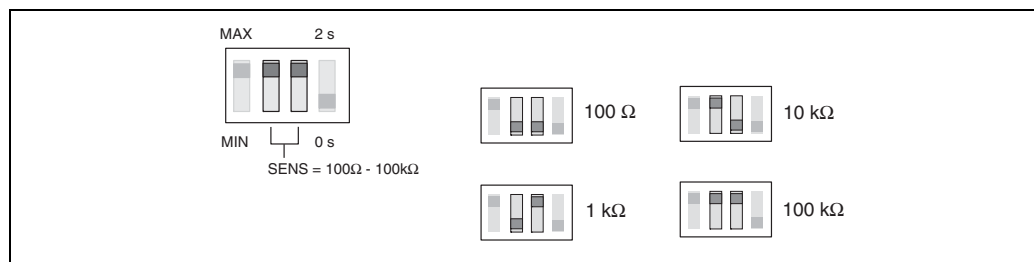

L00-FTW3xxxx-15-05-xx-xx-001

**Switching delay**

A switching delay of 2.0 s can be activated or deactivated via a DIL switch.

If the switching delay is set to 0 s, the device switches after approx. 0.3 s.

**Load**

Refer to the "Technical Data" of the connected isolating amplifier acc. to NAMUR (IEC 60947-5-6)

**Cable monitoring**

For probes without an electronic insert, an additional printed circuit board is installed in the housing to enable cable monitoring. It is always switched or connected between rod/rope 1 and 2.



Note!

When using switching units (transmitters) that do not support cable monitoring, these must be removed.



## Power supply

### Compact instrument version with FEW52

#### Transistor circuit for load

The load connected to terminal 3 is switched by a transistor, contactless and therefore without bouncing. In normal switch status, terminal 3 has a positive signal.

The transistor is blocked in the event of a level alarm or a power failure.

#### Protection against voltage peaks

When connecting a device with high inductance, always connect a voltage limiter.

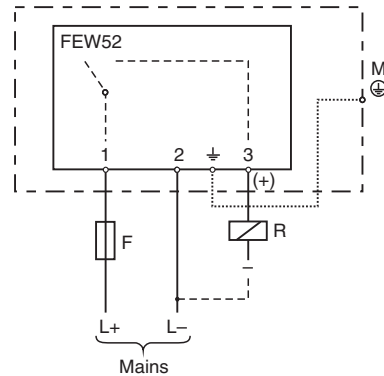

Connecting the FEW52 electronic insert  
*F: Fine-wire fuse 500 mA, semi-time lag*  
*M: Ground connection to protective earth*

L00-FTW3xxxx-04-05-xx-en-001

#### Supply voltage (FEW52)

- Supply voltage:  $U = 10.8 \text{ V to } 45 \text{ V}$
- Load connection: open collector; PNP
- Switching voltage: max. 45 V
- Connected load, continuous: max. 200 mA
- Protected against reverse polarity

#### Power consumption

$$P < 1.1 \text{ W}$$

#### Current consumption

$$I < 25 \text{ mA (without load)}$$

**Compact instrument version  
with FEW54****Relay contact circuit for load**

The connected load is switched via potential-free relay contacts (change-over contact). In the event of a level alarm or a power failure, the relay contacts break the connections between terminals 3 and 4 and terminals 6 and 7. The relays always switch simultaneously.

**Protection against voltage peaks and short-circuits**

When connecting a device with high inductance, fit a spark barrier to protect the relay contact. A fine-wire fuse (load-dependent) can protect the relay contact in the event of a short-circuit.

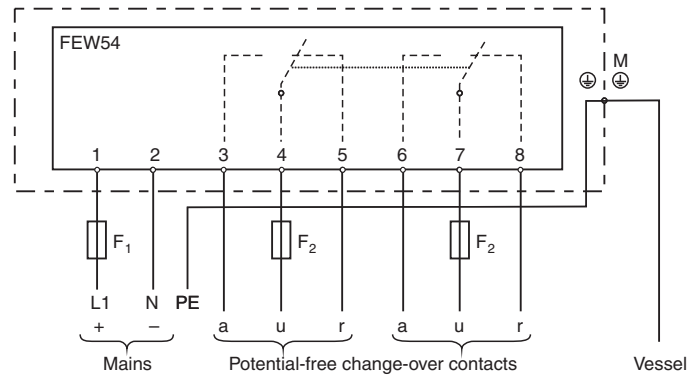

L00-FTW3xxxx-04-05-xx-es-002

Connecting the FEW54 electronic insert

$F_1$ : Fine-wire fuse 500 mA, semi-time lag

$F_2$ : Fine-wire fuse to protect the relay contact, load-dependent

M: Ground connection to protective earth (PE)

**Supply voltage (FEW54)**

- Supply voltage:  $U_{\text{DC}}$  20 V to 55 V DC or  $U_{\text{AC}}$  20 V to 253 V AC, 50/60 Hz
- Peak inrush current: max. 2 A, max. 400  $\mu\text{s}$
- Output: two potential-free change-over contacts
- Contact load capacity:  $U_{\text{AC}}$  max. 253 V,  $I_{\text{AC}}$  max. 4 A,  $U_{\text{DC}}$  30 V/4 A; 150 V/ 0.2 A

**Power consumption**

$P < 2.0 \text{ W}$

**Current consumption**

$I < 60 \text{ mA}$

**Compact instrument version with FEW58**

To be used with a separate switching unit acc. to IEC 60947-5-6 (NAMUR) e.g. Nivotester FTL325N from Endress+Hauser; Output signal jump from high to low current on point level (H-L edge).

Signal transmission on a two-wire line:  
H-L-edge 2.2 to 6.5 mA / 0.4 to 1.0 mA

When using a multiplex the cycle time must be set to a minimum of 2 s.

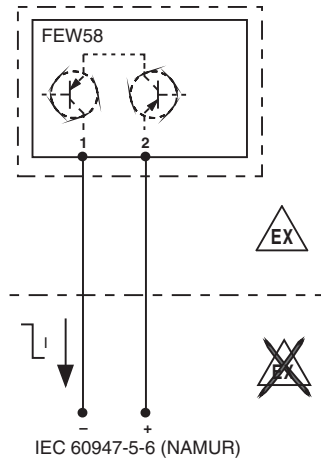

Connecting the FEW58 electronic insert

L00FTW3xxxx-04-05-xx-en-005.eps

**Supply voltage (FEW58)**

Refer to the "Technical Data" of the connected isolating amplifier acc. to IEC 60947-5-6 (NAMUR) e.g. Nivotester FTL325N from Endress+Hauser.

**Signal on alarm**

Output signal with damaged sensor: < 1.0 mA

**Separate instrumentation for probes with two rods or ropes with cable monitoring**

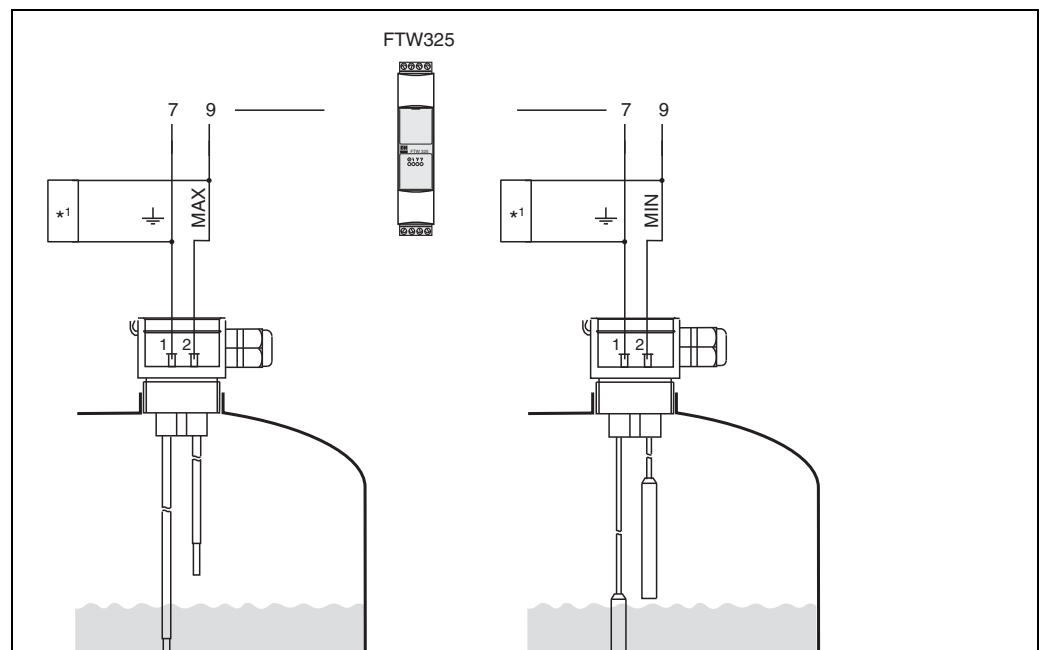

L00-FTW3xxxx-04-05-xx-en-003

\*1 Printed circuit board for cable monitoring (only required for probes with WHG certification.)  
The power supply and evaluation are provided by switching units, e.g. Nivotester FTW325

Separate instrumentation for probes with three rods or ropes with cable monitoring

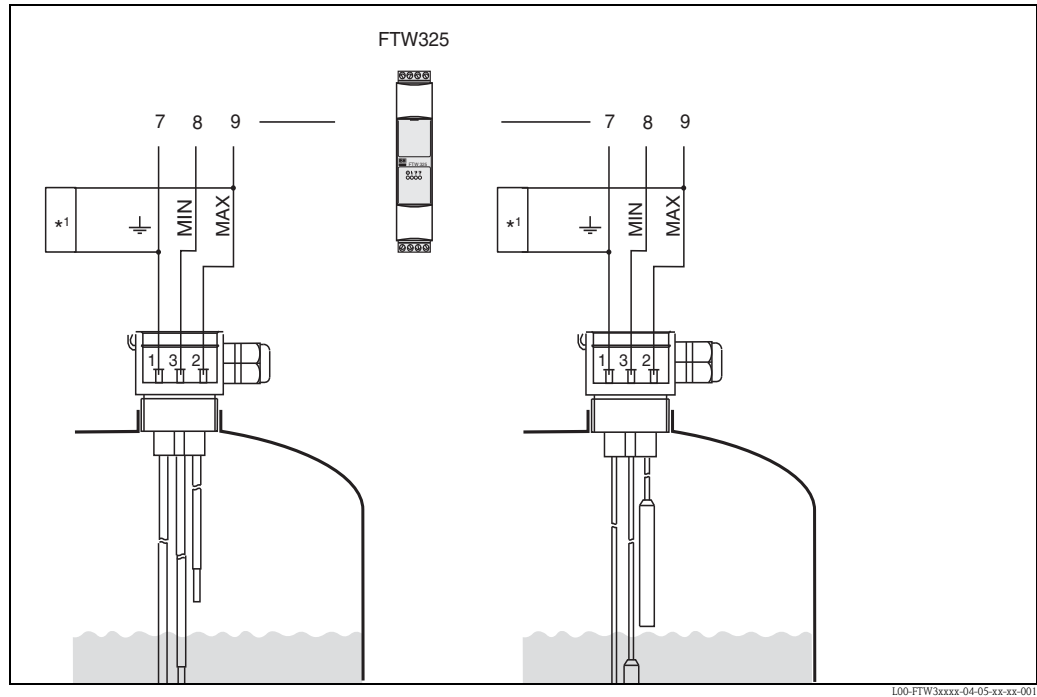

\*1 Printed circuit board for cable monitoring (only required for probes with WHG certification.)  
The power supply and evaluation are provided by a switching unit, e.g. Nivotester FTW325

Separate instrumentation for probes with five rods or ropes with cable monitoring

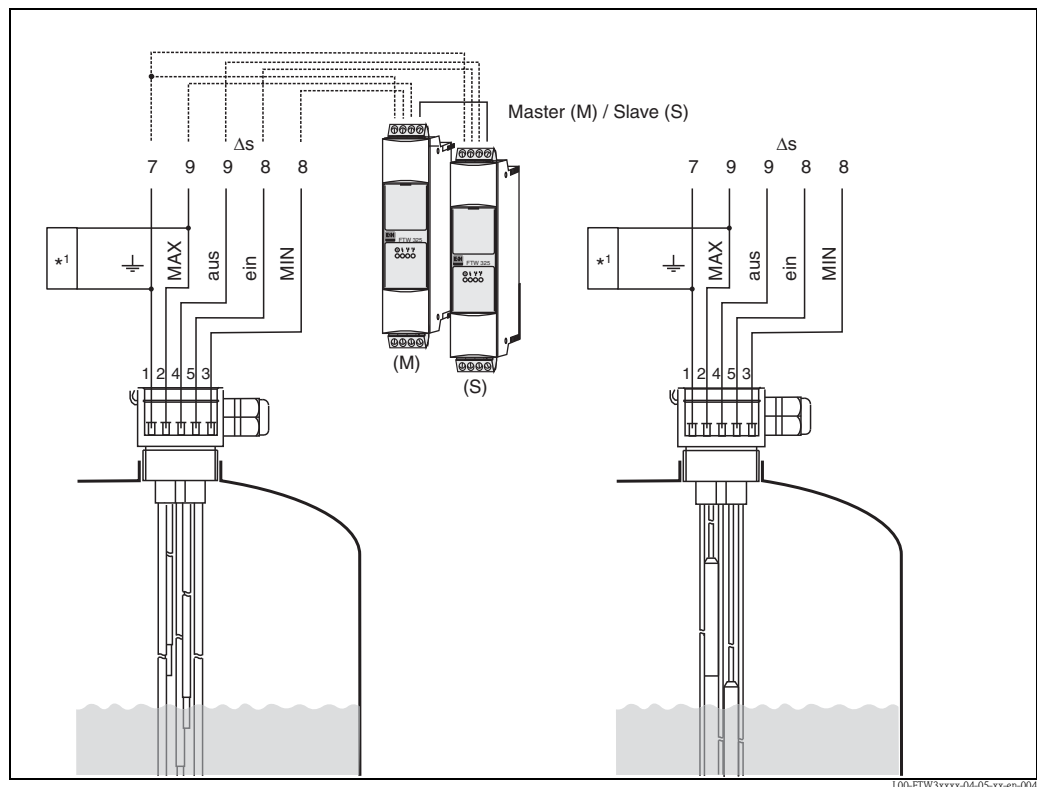

\*1 Printed circuit board for cable monitoring (only required for probes with WHG certification.)  
The power supply and evaluation are provided by a switching unit, e.g. Nivotester FTW325

<b>Cable entry</b>	<b>M 20x1.5 and NPT 1/2 "</b> <ul style="list-style-type: none"> <li>■ Quantity in F24 housing: 1 (separate instrument version)</li> <li>■ Quantity in F16 housing: 2 (compact instrument version)</li> <li>■ Conductor cross-section (including wire end sleeve): 2.5 mm<sup>2</sup> (14 AWG)</li> </ul>
--------------------	---

<b>Cable specifications</b>	Use a commercially available cable (25 Ω per wire).
-----------------------------	---

## Performance characteristics



Note!  
When electronic insert is installed!

<b>Reference operating conditions</b>	<ul style="list-style-type: none"> <li>■ Ambient temperature: 23 °C (73 °F)</li> <li>■ Medium temperature: 23 °C (73 °F)</li> <li>■ Medium viscosity: medium must release the probe again (drain off).</li> <li>■ Medium pressure <math>p_e</math>: 0 bar (0 psi)</li> <li>■ Probe installation: vertically from above</li> </ul>
---------------------------------------	---

<b>Measuring error</b>	$\pm 10\%$ at 100 Ω - 100 kΩ $\pm 5\%$ at 1 kΩ - 10 kΩ
------------------------	---

<b>Non-repeatability</b>	$\pm 5\%$ at 100 Ω - 100 kΩ $\pm 1\%$ at 1 kΩ - 10 kΩ
--------------------------	--

<b>Hysteresis</b>	- 10% for the MAX probe, in reference to the switch point. $\Delta s$ function disabled.
-------------------	--

<b>Switch-on delay</b>	< 3 s
------------------------	-------

<b>Influence of ambient temperature</b>	< 0.05 %/K
---	------------

## Installation

<b>Mounting location</b>	<b>Tanks</b> The rod and rope probes are mounted predominantly in tanks.
--------------------------	---

### Piping (partially filled)

Two-rod probes can be used in piping as, for example, dry running protection for pumps.

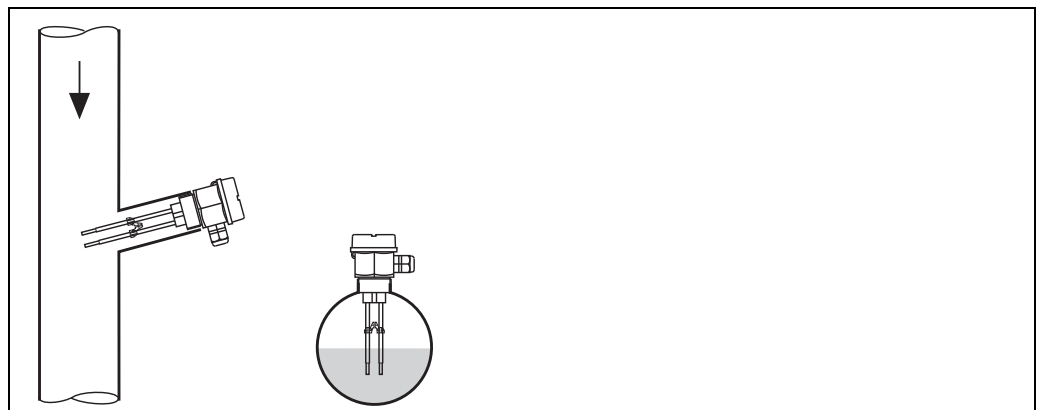

100-FTW3xxxx-11-05-xx-xx-001

Orientation of probes

Point level detection

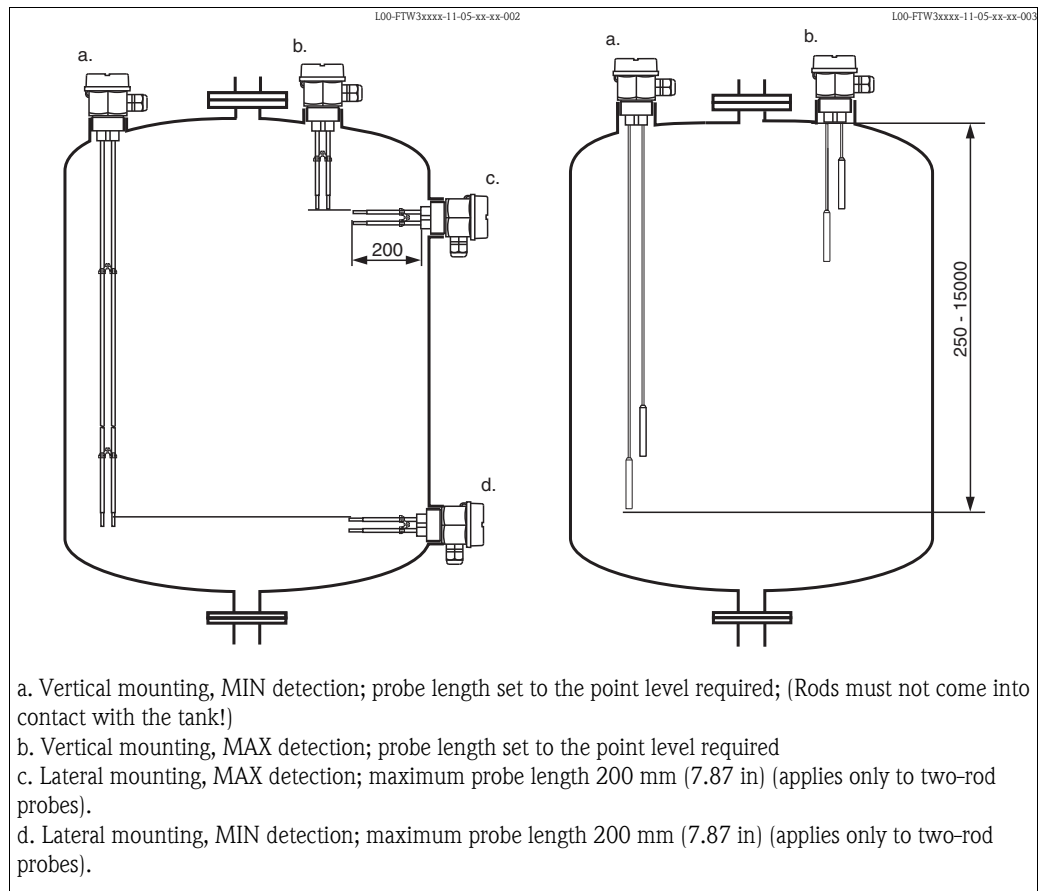

Example applications

Point level detection: Two-point control ( $\Delta s$ )

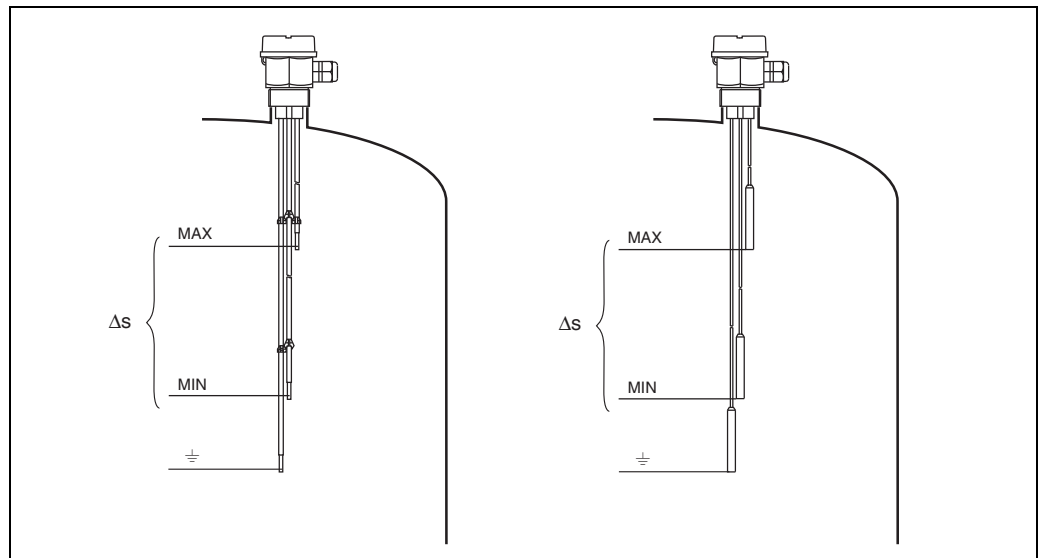

Two-point control ( $\Delta s$ ) e.g. pump control

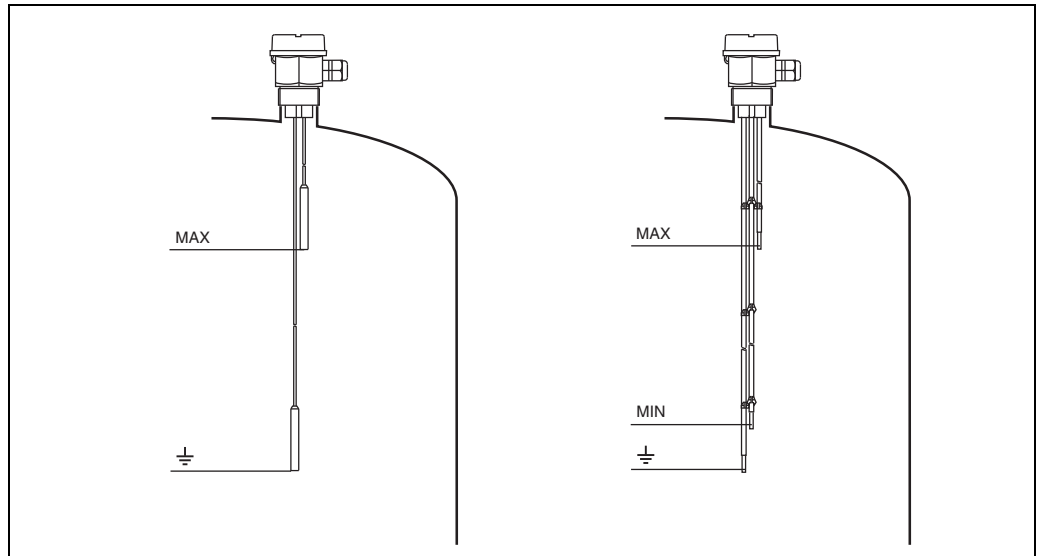
**Point level detection: MAX and MIN detection**

L00-FTW3xxxx-15-05-xx-xx-003

Point level detection (MAX),  
MAX and MIN detection for compact instrument version only possible with Δs.

**Environment**

<b>Ambient temperature range</b>	<b>Non-hazardous area</b> <ul style="list-style-type: none"> <li>■ -40 to 70 °C (-40 to 158 °F)</li> <li>■ -40 to 60 °C (-40 to 140 °F) for FEW58 NAMUR</li> </ul>
<b>Storage temperature</b>	-40 to 80 °C (-40 to 176 °F)
<b>Climate class</b>	Tropicalized as per DIN EEC 68, part 2-38
<b>Degree of protection</b>	IP66
<b>Shock resistance</b>	Practical test
<b>Vibration resistance (at min. rod length)</b>	DIN 60068-2-64 / IEC 68-2-64: 20 to 2000 Hz, 1 (m/s <sup>2</sup> ) <sup>2</sup> /Hz
<b>Electromagnetic compatibility</b>	<ul style="list-style-type: none"> <li>■ Interference Emission to EN 61326, Electrical Equipment Class B</li> <li>Interference Immunity to EN 61326, Annex A (Industrial)</li> <li>■ Use for separate-instrumented probes a screened cable between the probe and the switching unit. For installation instructions for screened cables and general instructions for EMC inspection conditions for E+H devices, see also TI00241F.</li> </ul>

## Process

**Conductivity**  $\geq 10 \mu\text{S}$

**Limiting medium pressure range** -1 to 10 bar (-1 psi)

### Environment

Permissible ambient temperature  $T_1$  at the housing as a function of the measuring material temperature  $T_2$  in the vessel:

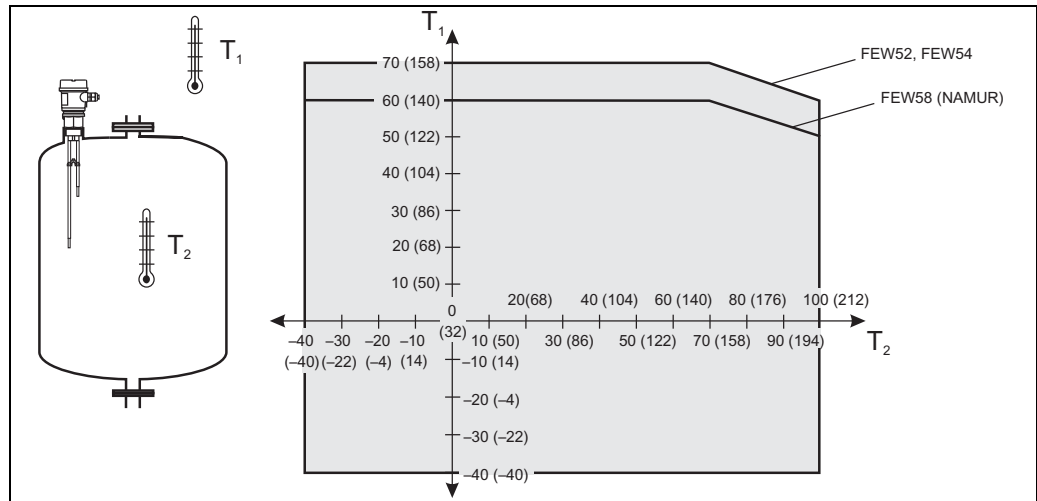

L00-FTW31xxxx-05-05-xx-xx-001



#### Note!

For separately instrumented devices (without FEW5x) there are no restrictions in the indicated temperature range.



## Mechanical construction



Note!

All dimensions in mm (in)!

Design	Designation	Housing with electronic insert		Housing without electronic insert		
		Dimensions G 1 1/2	Dimensions NPT 1 1/2	Dimensions G 1 1/2	Dimensions NPT 1 1/2	
	A	85 (3.35)		66 (2.6)		
	B	76 (2.99)		64 (2.52)		
	C	145 (5.71)	168 (6.61)	64 (2.52)	86 (3.39)	
	D - across flats	55 (2.17)		55 (2.17)		
	E	22 (0.87)	23.5 (0.93)	22 (0.87)	23.5 (0.93)	
	F	15 (0.59)		15 (0.59)		
	G - Probe length rod - Probe length rope	100 to 4000 (3.94 to 157) 250 to 15000 (9.84 to 591)		100 to 4000 (3.94 to 157) 250 to 15000 (9.84 to 591)		

### Weights

Separate instrument version	2, 3 or 5 probes
Rod 1 m (3.3 ft) length	415 g, 530 g, 760 g (14.64 oz, 18.69 oz, 26.81 oz)
Rope 1 m (3.3 ft) length	390 g, 470 g, 640 g (13.76 oz, 16.58 oz, 22.57 oz)
Compact instrument version	2 or 3 probes
Rod 1 m (3.3 ft) length	600 g, 720 g (21.16 oz, 25.40 oz)
Rope 1 m (3.3 ft) length	710 g, 800 g (25.04 oz, 28.22 oz)

### Material

#### Wetted

- Seal between probe rod/probe rope and process connection: EPDM
- Spacer: PP
- Flat seal for process connection: elastomer fiber, (asbestos-free)
- Process connections:
  - G 1 1/2: PPS
  - NPT 1 1/2: PPS

#### Probe rods

- Rod: 316L (1.4404) or carbon fiber
- Insulation: PP

#### Probe ropes

- Rope: 316Ti (1.4571)
- Insulation: FEP
- Weight: 316L (1.4435)

**Not wetted**

- Plastic housing F24 (separate instrument version)
  - Housing: PPS
  - Cover: PBT
- Polyester housing F16: PBT-FR with PBT-FR cover or with PA12 transparent cover,
  - Cover seal: EPDM
  - Adapter: PBT-FR
  - Nameplate, glued: polyester foil (PET)
  - Pressure compensation filter: PBT-GF20
- Ground terminal on housing (outside): 304 (1.4301)
- Cable gland: polyamide (PA)

**Fitted electrodes****Rod probes**

Compact instrument version: 2 or 3 rods; Separate instrument version: 2, 3 or 5 rods

- Diameter without insulation: 4 mm (0.16 in)
- Maximum rod length: 4000 mm (157 in)
- Minimum rod length: 100 mm (3.94 in)
- Thickness of insulation: 0.5 mm (0.02 in)
- Length of non-insulated area (tip of rod): 20 mm (0.79 in)
- Extraction forces (parallel probe rod): 1000 N (224.8 lbf)

**Rope probes**

Compact instrument version: 2 or 3 rods; Separate instrument version: 2, 3 or 5 rods

- Diameter without insulation: 1 mm (0.04 in)
- Maximum rope length: 15000 mm (591 in)
- Minimum rope length: 250 mm (9.84 in)
- Thickness of insulation: 0.75 mm (0.03 in)
- Weight length: 100 mm (3.94 in) not insulated
- Weight diameter: 10 mm (0.39 in)
- Extraction forces (parallel probe rod): 500 N (112.4 lbf)

## Human interface

### Operating elements

#### FEW52, FEW54, FEW58

- One DIL switch for MIN or MAX safety
- One DIL switch for 0 s or 2 s switching delay
- Two DIL switches for setting the sensitivity level 100 Ω, 1 kΩ, 10 kΩ or 100 kΩ

### Display elements

#### Separate instrument version

The display elements are dependent on the connected switching unit.

#### Compact instrument version

##### FEW52

- One red light emitting diode: fault message, switch status
- One green light emitting diode: operation

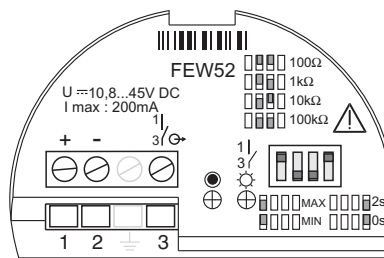

L00-FTW3xxxx-07-05-xx-xx-001

##### FEW54

- One red light emitting diode: fault message, switch status
- One green light emitting diode: operation

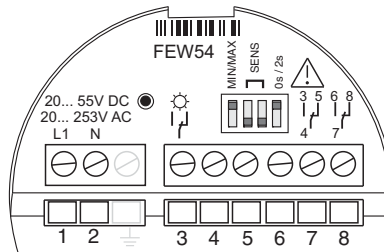

L00-FTW3xxxx-07-05-xx-xx-002

##### FEW58

- One yellow light emitting diode: fault message, switch status
- One green light emitting diode: operation

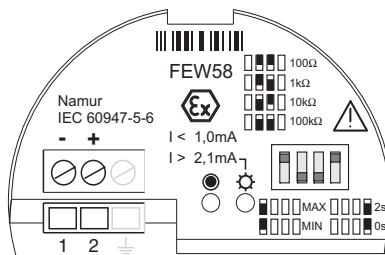

L00-FTW3xxxx-07-05-xx-xx-003

## Certificates and approvals

**CE mark** The Liquipoint T meets the legal requirements of the EC directives. Endress+Hauser confirms that the device has been successfully tested by applying the CE mark.

**Overfill protection** ■ WHG, leak test (leakage)

**Other standards and guidelines**

- Low voltage equipment directive (73/ 23/ EEC)
- DIN EN 61010 part 1, 2001  
Safety regulations for electrical equipment for measurement, control and laboratory use  
Part 1: General requirements
- EN 61326  
Electrical equipment for measurement, control and laboratory use  
EMC requirements

**RoHS** The measuring system complies with the substance restrictions of the Restriction on Hazardous Substances Directive 2011/65/EU (RoHS 2).

**RCM-Tick marking** The supplied product or measuring system meets the ACMA (Australian Communications and Media Authority) requirements for network integrity, interoperability, performance characteristics as well as health and safety regulations. Here, especially the regulatory arrangements for electromagnetic compatibility are met. The products are labelled with the RCM- Tick marking on the name plate.



A0029501

**Ex-approvals** For further information, please contact your local Endress+Hauser Sales Center. All data relevant to explosion protection can be found in separate Ex documentation (see: Documentation → 22) .

**Type of protection**

- [Ex ia] IIC (FEW58)
- [Ex na/C(L)] IIC (FEW52, FEW54)

## Ordering information

---

### Ordering information

Detailed ordering information is available as follows:

- In the Product Configurator on the Endress+Hauser website: [www.endress.com](http://www.endress.com) → Select country → Instruments → Select device → Product page function: Configure this product
- From your Endress+Hauser sales center: [www.endress.com/worldwide](http://www.endress.com/worldwide)

### Product Configurator - the tool for individual product configuration

- Configuration data updated on a daily basis
- Depending on the device: Direct input of data specific to measuring point, such as measuring range or operating language
- Automatic verification of exclusion criteria
- Automatic generation of order code with breakdown in PDF or Excel output format
- Possibility to order directly from the Endress+Hauser online shop

## Accessories

---

### Liquipoint T

#### Lock nut G 1 1/2"

- Hexagon: AF 60
- Material: PC-FR
- Part number: 52014146

#### Electronic insert FEW52

- Output PNP 10.8 to 45 V DC
- Part number: 52017271

#### Electronic insert FEW54

- Output relay 20 to 253 V AC, 20 to 55 V DC
- Part number: 52017272

#### Electronic insert FEW58

- Output NAMUR (IEC 60947-5-6)
- Part number: 52017273

---

## Documentation



Note!

This documentation can be found on the product pages at "[www.endress.com](http://www.endress.com)".

---

### Operating Instructions

Liquipoint T FTW31, FTW32  
KA00204F/00

---

### Certificates

#### WHG

- Liquipoint T FTW31, FTW32  
ZE00043F/00

#### ATEX II 3G EEx nA/C(L) IIC T6

- Liquipoint T FTW31, FTW32  
XA00226F/00

#### ATEX II 2G EEx ia IIC T6

- Liquipoint T FTW31, FTW32  
XA00230F/00





71336942

[www.addresses.endress.com](http://www.addresses.endress.com)

---