



—
your partner
in sensor
technology.

+ Datasheet EE33

**Humidity / Temperature Sensor for
High Humidity and Chemical Applications**



EE33

Humidity / Temperature Sensor for High Humidity and Chemical Applications

The EE33 sensors are designed to meet the highest demands of stable and highly accurate measurements of relative humidity (RH) and temperature (T) under the most challenging conditions. EE33 is suitable for a wide range of applications from -40 °C (-112 °F) up to 180 °C (356 °F) and 100 bar (1450 psi).

Outstanding Measurement Performance

The employed high-end E+E RH and T sensing element is heated and enables reliable and long-term stable measurements in extremely humid or chemically polluted environment. The monolithic structure of the sensor allows a fast return to normal conditions after condensation or chemical contamination. In addition it is perfectly protected by the E+E proprietary coating.

Versatility and Robustness

The EE33 is available in six remote probe types and with various probe and cable lengths. With different heating modes of the monolithic RH and T sensing element, the EE33 can be perfectly tailored to the specific needs of each measurement task. It features an IP65/NEMA 4 polycarbonate or metal enclosure which can accommodate various interface modules and electrical connection options.

Outputs and Configuration

The measured data is available on two freely scalable analogue outputs, on the RS232 or RS485 interface and on the alarm (relay) outputs. The configuration and the RH and T adjustment of the EE33 can be performed either using the push buttons or with the free EE-PCS Product Configuration Software.



Metal enclosure with display



Types of remote probes

Features

Measurement performance

- High RH/T accuracy
- Working range from -40 °C (-112 °F) up to 180 °C (356 °F) and 100 bar (1450 psi)
- Designed for conditions with chemical contamination and condensation
- Calculated parameters
 - Dew point temperature (Td)
 - Frost point temperature (Tf)
 - Wet bulb temperature (Tw)
 - Water vapour partial pressure (e)
 - Mixing ratio (r)
 - Absolute humidity (dv)
 - Specific enthalpy (h)

Enclosure

- Polycarbonate IP65 / NEMA 4X
- Metal (AlSi9Cu3) IP65 / NEMA 4
- Display with MIN/MAX function
- Versatile connection options



Outputs

- 2 freely scalable analogue outputs current / voltage
- Configurable via EE-PCS
- Digital RS232 / RS485 interface with E+E industry protocol

RH and T Sensing Element

- With different heating modes
 - Condensation Prevention (CP)
 - Automatic ReCover (ARC)
 - Overheating (OH)
- Protected by
 - E+E proprietary coating
 - Wide choice of filter caps

Remote probes

- Specific types according to
 - T range
 - p range
 - Environmental condition
- Various probe and cable lengths

Inspection certificate

According to DIN EN 10204-3.1

Features

Protective Sensor Coating

The E+E proprietary sensor coating is a protective layer applied to the sensing elements, their leads and soldering points. The coating substantially extends sensor lifetime and ensures optimal measurement performance in corrosive environment (salts, off-shore applications). Additionally, it improves the sensors' long term stability in dusty, dirty or oily applications by preventing stray impedance caused by deposits on the active sensor surface or on the electrical connections.

Heating Modes

Condensation Prevention (CP) describes an intense heating of the sensing element in order to get rid of temporary condensation. It is triggered by a certain RH setpoint (configurable via EE-PCS).

Automatic ReCover (ARC) describes an intense heating of the sensing element in order to get rid of chemical pollution. It is triggered either by a certain time interval (configurable via EE-PCS), externally using the ARC module option (AM1) or manually via push button on the PCB.

Overheating (OH) means a continuous, regulated warming of the sensing element and the probe body (dual heating system) to prevent condensation on it. Thanks to the monolithic structure of the sensing element precise RH measurement even under continuously high humidity and condensing conditions is enabled.

Heating Mode	Condensation Prevention (CP)	Automatic ReCover (ARC)	OverHeating (OH) with Dual Heating System
Use	Against temporary condensation	Against chemical pollution	In environments with continuous high humidity and condensation
Function trigger	RH setpoint*)	Cyclic, externally, manually	Always ON
EE33 Type			
EE33 Type T4/T5/T8/T10	✓	✓	Not available
EE33 Type T7/T17	Not usable due to OH	✓	✓

*) Factory setting: disabled, RH setpoint preset to 99 %.

Dimensions

Values in mm (inch)

Enclosure

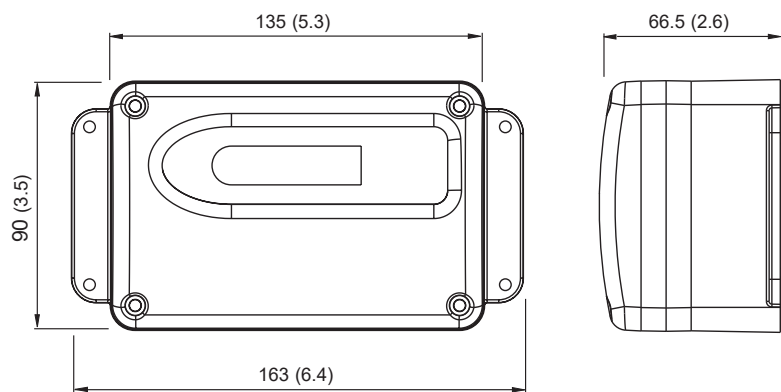

Type T4/ T5

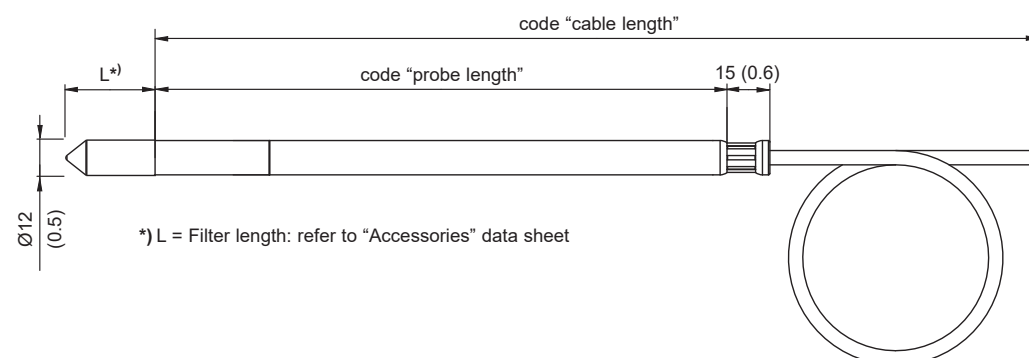

Type T7, pressure tight up to 20 bar (300 psi) for Td measurement with optional cut-in fitting

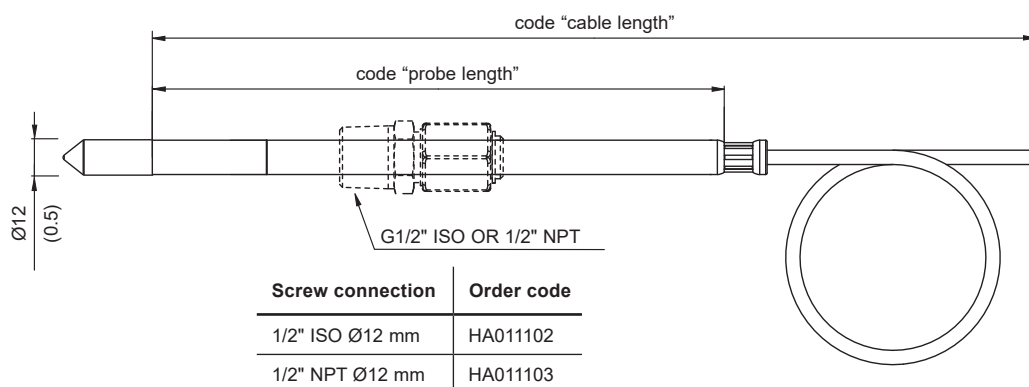

Dimensions

Values in mm (inch)

Type T8, pressure tight up to 100 bar (1 450 psi) with cut-in fitting

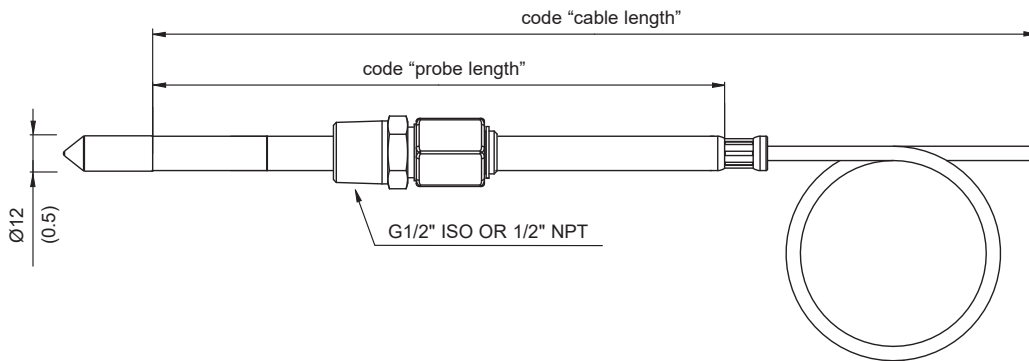

Type T10, pressure tight up to 20 bar (300 psi) with sliding fitting

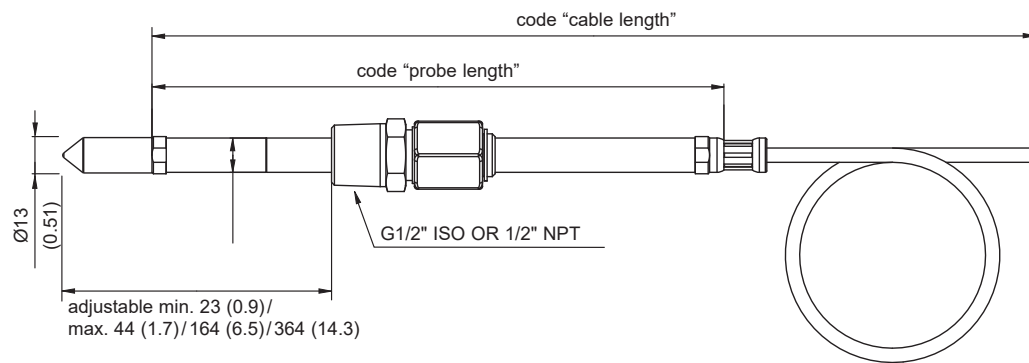

Dimensions

Values in mm (inch)

Type T17, two remote probes pressure tight up to 20 bar (300 psi) with optional cut-in sliding fitting

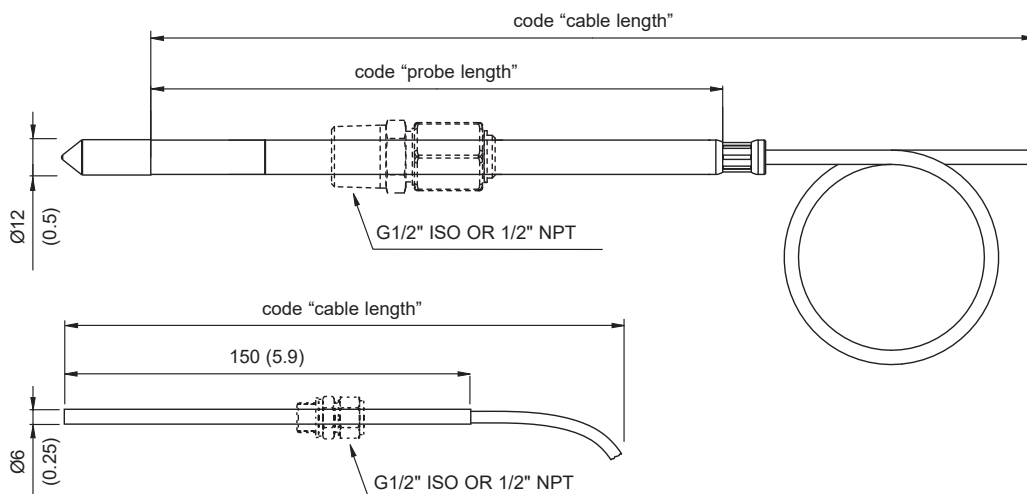

Screw connection	Order code
1/2" ISO Ø12 mm	HA011102
1/2" NPT Ø12 mm	HA011103
1/2" ISO Ø6 mm	HA011104
1/2" NPT Ø6 mm	HA011105

Technical Data

Measurands

Relative Humidity (RH)

Measuring range	0...100 %RH
Accuracy¹⁾ including hysteresis, non-linearity and repeatability	
-15...+40 °C (5...104 °F), RH ≤ 90 %	±(1.3 + 0.003 * mv) %RH
-15...+40 °C (5...104 °F), RH > 90 %	±2.3 %RH
-25...+70 °C (-13...+158 °F)	±(1.4 + 0.01 * mv) %RH
-40...+180 °C (-40...+356 °F)	±(1.5 + 0.015 * mv) %RH
	mv = measured value
Temperature dependency of electronics, typ.	±0.01 %RH/°C (0.0056 %RH/°F)
Response time t₉₀, typ. with stainless steel grid filter at 20°C (68°F)	≤15 s

1) Traceable to international standards, administrated by NIST, PTB, BEV, ...
The accuracy statement includes the uncertainty of the factory calibration with an enhancement factor k=2 (2-times standard deviation).
The accuracy was calculated in accordance with EA-4/02 and with regard to GUM (Guide to the Expression of Uncertainty in Measurement).

Technical Data

Measurands

Temperature (T)

Probe measuring range	Type T4 Type T5/T7/T8/T10/T17	-40...120 °C (-40...248 °F) -40...180 °C (-40...356 °F)
Accuracy¹⁾		
Temperature dependency of electronics, typ.	±0.005 °C/°C (±0.009 °F/°F)	

1) Traceable to international standards, administrated by NIST, PTB, BEV, ...
 The accuracy statement includes the uncertainty of the factory calibration with an enhancement factor k=2 (2-times standard deviation).
 The accuracy was calculated in accordance with EA-4/02 and with regard to GUM (Guide to the Expression of Uncertainty in Measurement).

Calculated Measurands

		from		up to						unit	
				EE33-xT4		EE33-xT5/T8/T10/T17		EE33-xT7			
Dew point temperature	Td	-40	(-40)	100	(212)	100	(212)	100	(212)	°C	(°F)
Frost point temperature¹⁾	Tf	-40	(-40)	0	(32)	0	(32)	0	(32)	°C	(°F)
Wet bulb temperature	Tw	0	(32)	100	(212)	100	(212)	–		°C	(°F)
Water vapour partial pressure	e	0	(0)	1100	(15)	1100	(15)	–		mbar	(psi)
Mixing ratio	r	0	(0)	999	(9999)	999	(9999)	–		g/kg	(gr/lb)
Absolute humidity	dv	0	(0)	700	(300)	700	(300)	–		g/m ³	(gr/ft ³)
Specific enthalpy	h	0	(0)	2800	(1250)	2800	(1250)	–		kJ/kg	(BTU/lb)

1) Equals Td above 0 °C (32 °F)

Technical Data

Outputs

Analogue



Two freely selectable and scalable outputs for RH and T	0 - 1 / 5 / 10 V 0 - 20 mA / 4 - 20 mA (3-wire) Both outputs have the same electrical quantity (U, I)	-1 mA < I _L < 1 mA R _L < 500 Ω	I _L = load current R _L = load resistance
Two alarm outputs with option AM2 ¹⁾	2x changeover contact 250 V AC / 6 A Measurand, threshold and hysteresis configurable via EE-PCS	28 V DC / 6 A	

1) Appropriate for outdoor use, wet location, degree of pollution 2, overvoltage category II, altitude up to 3 000 m (9 843 ft)

Digital

Digital interface	RS232 or RS485 (EE33 = 1 unit load)
Protocol Factory settings	E+E Industrial Transmitter Protocol 9600 Baud, parity even, 1 stop bit, ID = unique factory set

General

Power supply class III  USA & Canada: Class 2 supply necessary, max. voltage 30 V DC	8 - 35 V DC 12 - 30 V AC
Current consumption , typ. @ 24 V DC / AC 2x voltage output @ 24 V DC / AC 2x current output	40 mA / 80 mA _{rms} 80 mA / 160 mA _{rms}
Electrical connection	Screw terminals max. 1.5 mm ² (AWG 16)
Cable gland	M16x1.5 for cable Ø4.5 - 10 mm (0.18 - 0.39")
Pressure range for pressure tight probe Type T7/T10/T17 Type T8	0.01...20 bar (0.15...300 psi) 0.01...100 bar (0.15...1 450 psi)
Probe material	Stainless steel 1.4404
Enclosure Material, protection rating Working and storage temperature range Without display With display	Polycarbonate (PC) IP65/NEMA 4X Metal (AlSi9Cu3) IP65/NEMA 4 -40...+60 °C (-40...+140 °F), non-condensing -20...+50 °C (-4...+122 °F), non-condensing
Electromagnetic compatibility	EN 61326-1 EN 61326-2-3 Industrial environment FCC Part15 Class A ICES-003 Class A
Conformity	 
Configuration and adjustment	PCS10 Product Configuration Software (free download) and configuration cable HA010304

Ordering Guide

Feature	Description	Code					
		EE33-					
Model	RH + T	M1					M4
	Td						
Type	Remote probe up to 120 °C (248 °F)	T4					
	Remote probe up to 180 °C (356 °F)		T5				
	Remote probe, pressure tight up to 20 bar (300 psi) and 180 °C (356 °F)			T10			
	Remote probe, pressure tight up to 100 bar (1450 psi) and 180 °C (356 °F)				T8		
	Two remote probes, pressure tight up to 20 bar (300 psi) and 180 °C (356 °F)					T17	
	Remote probe for cut-in fitting, pressure tight up to 20 bar (300 psi) and 180 °C (356 °F)						T7
Enclosure material	Polycarbonate (PC)					No code	
	Metal (AlSi9Cu3)	HS3	HS3	HS3	HS3	HS3	HS3
Filter	Stainless steel sintered	F4	F4	F4	F4		
	Polytetrafluoroethylene (PTFE)	F5	F5	F5	F5		
	Stainless steel grid, stainless steel body (180 °C / 356 °F)	F9	F9	F9	F9	F9	F9
	PTFE membrane, stainless steel body					F11	F11
Probe cable length	2 m (6.6 ft)	K2					
	5 m (16.4 ft)	K5					
	10 m (32.8 ft)	K10					
Probe length	65 mm (2.56")	L65	L65			L65	L65
	80 mm (3.15")			L80			
	200 mm (7.87")	L200	L200	L200	L200	L200	L200
	400 mm (15.75")	L400	L400	L400	L400	L400	L400
Process connection	G1/2" ISO - sliding fitting, Ø13 mm (0.51")			PA23			
	1/2" NPT - sliding fitting, Ø13 mm (0.51")			PA25			
	G1/2" ISO - cut-in fitting, Ø12 mm (0.47")				PA20		
	1/2" NPT - cut-in fitting, Ø12 mm (0.47")				PA22		
Electrical connection	Standard ¹⁾	No code					
	1 x plug for power supply and outputs	E4					
	2 x plugs for power supply + outputs and RS485 network	E7					
Digital Interface	RS232	No code					
	RS485	J3					
Display	Without display	No code					
	Display with backlight	D2					
Probe connection	Fixed	No code					
	Connectable on electronics board	PC6					
Sensing element protection	E+E proprietary coating	C1					
Additional modules	Without	No code					
	ARC module for external trigger of sensor heating ²⁾³⁾	AM1					
	Alarm output with relay ²⁾	AM2					
Output signal⁴⁾	0 - 1 V	GA1					
	0 - 5 V	GA2					
	0 - 10 V	GA3					
	0 - 20 mA	GA5					
	4 - 20 mA	GA6					
Output 1 measurand	Relative humidity RH [%]	No code					
	Other measurand (xx see measurand code below)	MAxx					MAxx
Output 1 scaling low	0	No code					
	Value	SALValue					SALValue
Output 1 scaling high	100	No code					
	Value	SAHValue					SAHValue
Output 2 measurand	Temperature T [°C]	No code					
	Other measurand (xx see measurand code below)	MBxx					MBxx ⁵⁾
Output 2 scaling low	-40	No code					
	Value	SBLValue					SBLValue
Output 2 scaling high	60	No code					
	Value	SBHValue					SBHValue

Hardware Configuration

Software Setup Analogue Outputs

- 1) Standard = 2 x M16 cable glands
- 2) With electrical connection standard only (no plug options possible)
- 3) Sensor needs to be supplied with 24V AC/DC ±20 %, digital interface occupied
- 4) Applies to both outputs
- 5) Only with Measurand Codes Mx52/53/65/66

Measurand Code

For Output 1 and 2 in the Ordering Guide

Measurand	Unit		Code
			MAxx / MBxx
Relative humidity	RH	%	10
Temperature	T	°C	1
		°F	2
Dew point	Td	°C	52
		°F	53
Frost point	Tf	°C	65
		°F	66
Mixing ratio	r	g/kg	60
		gr/lb	61
Absolute humidity	dv	g/m ³	56
		gr/ft ³	57
Wet bulb temperature	Tw	°C	54
		°F	55
Water vapour partial pressure	e	mbar	50
		psi	51
Specific enthalpy	h	kJ/kg	62
		BTU/lb	64



Please note: no mix of SI/US units allowed.

Order Example

EE33-M1T10HS3F9K2L200PA23E4C1GA6

Feature	Code	Description
Model	M1	RH + T
Type	T10	Remote probe, pressure tight up to 20 bar (300 psi) and 180 °C (356 °F)
Enclosure material	HS3	Metal (AISI9Cu3)
Filter	F9	Stainless steel grid, stainless steel body (180 °C / 356 °F)
Cable length	K2	2 m (6.6 ft)
Probe length	L200	200 mm (7.87")
Process connection	PA23	G1/2" ISO - sliding fitting, Ø13 mm (0.51")
Electrical connection	E4	1 x plug for power supply and outputs
Digital interface	No code	RS232
Display	No code	Without display
Probe connection	No code	Fixed
Sensing element protection	C1	E+E proprietary coating
Additional modules	No code	Without
Output signal	GA6	4 - 20 mA
Output 1 measurand	No code	Relative humidity RH [%]
Output 1 scaling low	No code	0
Output 1 scaling high	No code	100
Output 2 measurand	No code	Temperature T [°C]
Scaling 2 low	No code	-40
Scaling 2 high	No code	60

Order Example

EE33-M1T17F11K5L200D2C1AM1GA3MB52SBL0SBH100

Feature	Code	Description
Model	M1	RH + T
Type	T17	Two remote probes, pressure tight up to 20 bar (300 psi) and 180 °C (356 °F)
Enclosure material	HS3	Metal (AlSi9Cu3)
Filter	F11	PTFE membrane, stainless steel body
Cable length	K5	5 m (16.4 ft)
Probe length	L200	200 mm (7.87")
Electrical connection	No code	Standard (2 M16 cable glands)
Digital interface	No code	RS232
Display	D2	Display with backlight
Probe connection	No code	Fixed
Sensing element protection	C1	E+E proprietary coating
Additional modules	AM1	ARC module for external trigger of sensor heating
Output signal	GA3	0 - 10 V
Output 1 measurand	No code	Relative humidity RH [%]
Output 1 scaling low	No code	0
Output 1 scaling high	No code	100
Output 2 measurand	MB52	Dew point Td [°C]
Scaling 2 low	No code	0
Scaling 2 high	No code	100

Accessories

For further information see datasheet [Accessories](#).

Accessories	Code
E+E Product Configuration Software (free download from www.epluse.com/configurator)	EE-PCS
EE33 Configuration cable (for EE-PCS)	HA010304
Stainless steel mounting flange Ø12 mm (0.47")	HA010201
Stainless steel mounting flange for Ø6 mm (0.24") T probe	HA010207
Stainless steel wall mounting clip Ø12 mm (0.47")	HA010225
Pressure tight screw connections	G1/2" ISO Ø12 mm HA011102 1/2" NPT Ø12 mm HA011103 G1/2" ISO Ø6 mm HA011104 1/2" NPT Ø6 mm HA011105
Humidity calibration kit	see Humidity Calibration Kit data sheet
RS232 interface cable for plug option E5	HA010311
RS485 kit for network	HA010605
Adapter M16x1.5 to NPT 1/2"	HA011101
Drip water protection	HA010503
Radiation shield for RH probe	HA010502
Radiation shield for T probe	HA010506

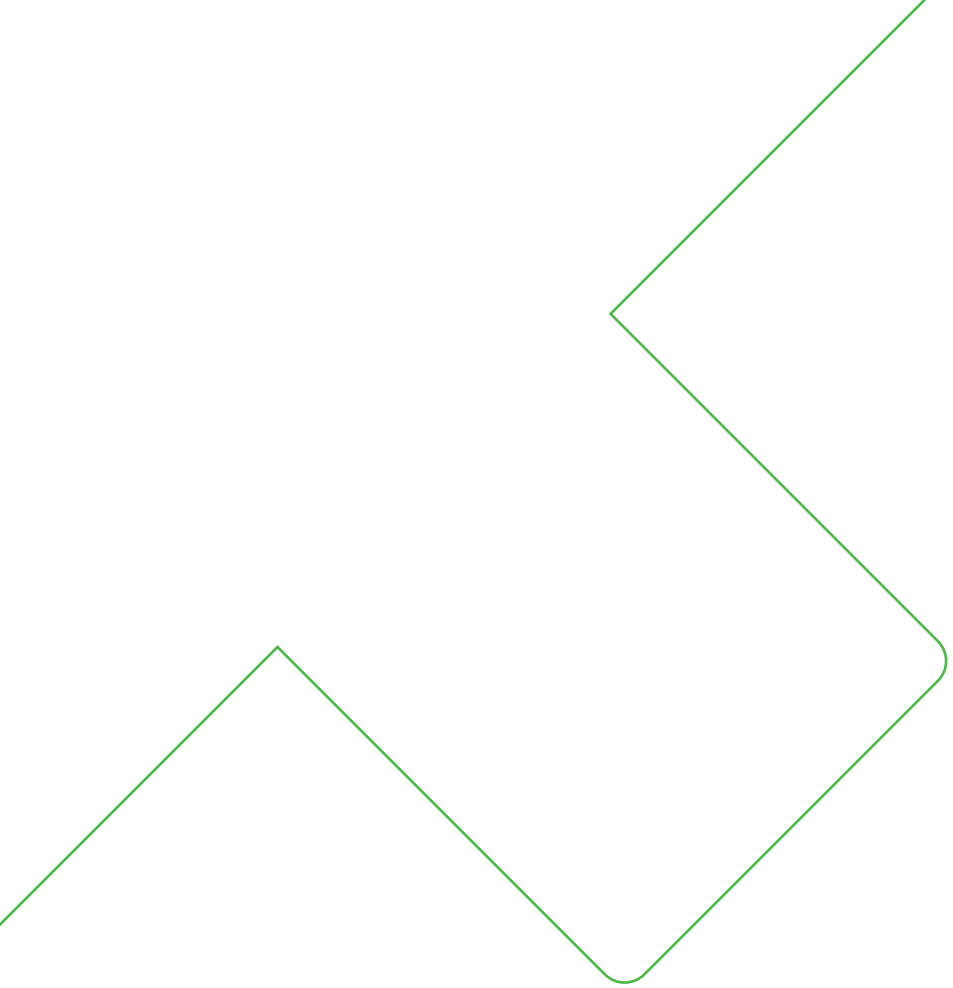

Company Headquarters &
Production Site

E+E Elektronik Ges.m.b.H.
Langwiesen 7
4209 Engerwitzdorf | Austria
T +43 7235 605-0
F +43 7235 605-8
info@epluse.com
www.epluse.com

Subsidiaries

E+E Sensor Technology (Shanghai) Co., Ltd.
T +86 21 6117 6129
info@epluse.cn

E+E Elektronik France SARL
T +33 4 74 72 35 82
info.fr@epluse.com

E+E Elektronik Deutschland GmbH
T +49 6171 69411-0
info.de@epluse.com

E+E Elektronik India Private Limited
T +91 990 440 5400
info.in@epluse.com

E+E Elektronik Italia S.R.L.
T +39 02 2707 86 36
info.it@epluse.com

E+E Korea Co., Ltd.
T +82 31 732 6050
info.kr@epluse.com

E+E Elektronik Corporation
T +1 847 490 0520
info.us@epluse.com

Version v1.17 | 01-2023
Modification rights reserved



—
your partner
in sensor
technology.

www.epluse.com