



ETHERNET I/O MODULES

Various Digital I/O Function

Modbus TCP/UDP Protocol

32-bit Counter Function

Pair-connection Function

Low Power consumption

Easy Web configuration

Cost-effective



● Introduction

The functionality of the PETL-7000/t(P)ET series modules is almost the same as the PET-7000. The major difference is that the PET-7000 module supports user-defined web HMI interface and more connections, while the PETL-7000/t(P)ET supports higher speed of DI counter, frequency measurement, DO as PWM and ultra low power consumption. Especially the t(P)ET modules are designed with tiny form factor and small channel count that are suitable in room control and monitor applications.

Comparison Item	tPET	PETL-7000	PET-7000
CPU	32-bit ARM		80186
Ethernet	10/100 M, PoE		
Modbus TCP/UDP	Yes		
Web Configuration	Yes		
Web HMI	Simplified		Yes
Multi-client	Yes (Max. Connections: 5)		Yes (Max. Connections: 12)
IP Filter	Yes (white list)		
Latched DI	Yes		
DI as Counter	32-bit, 3.5 kHz		32-bit, 500 Hz
I/O Pair-Connection	Yes (Poll/Push Mode)		Yes (Poll Mode)
PWM	Yes (100 Hz Max.)		-
Frequency Measurement	Yes (3.5 kHz Max.)		-
Dual Watchdog	Yes (CPU, host)		Yes (Module, host)
ESD Protection	+/- 4 kV		
Surge Protection	-		+/- 0.5 kV
Form Factor	Tiny Size		Palm Size
Remarks	Cost-effective		-

Note: tET = tPET without PoE.

DIO Pair-Connection (Mirror)

The PETL-7000/t(P)ET series Ethernet I/O modules support various I/O types, like photo-isolated digital input, relay contact, PhotoMOS relay, and open-collector output. The module can be used to create DI to DO pair-connection (mirror) through the Ethernet. Once the configuration is completed, the modules can automatically read the local DI status and write to remote DO channels via the Modbus TCP protocol in the background. It's useful when connecting digital I/O devices that do not themselves have Ethernet capability.

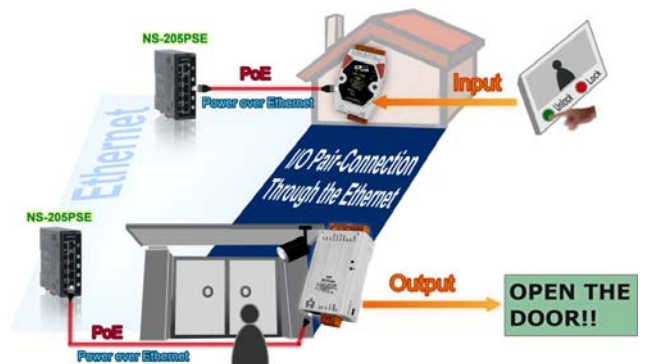

DO as PWM (Pulse Width Modulation)

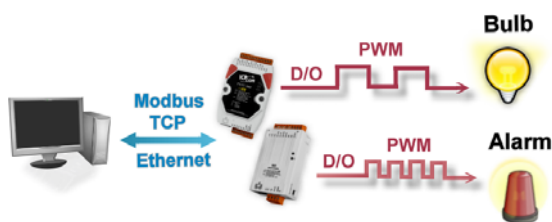

The DOs on the PETL-7000/t(P)ET series provide PWM (pulse width modulation, pulse generator) function that can be used in applications such as alarm light, flash light controls... etc. Once the configuration is finished, the module will automatically and continuously switch the DO output ON and OFF. This removes the busy control by remote host and also reduces the network loadings. Users can set different frequency (50 or 100 Hz Max.) and duty cycle

for the PWM function in each digital output channel. In addition, the two DO channels can work independently or simultaneously. This function reduces the complexity of the control system and enhances the timing accuracy of pulse output.

32-bit High Speed Digital Counter

Polling the remote DI status back and then counting the ON/OFF changes in host computer may get quantity errors caused by communication delay. The PETL-7000/t(P)ET series module has built-in 32-bit counter function; it counts the DI ON/OFF changes in site to prevent counting errors caused by the communication latency. The 32-bit counter of the PETL-7000/t(P)ET modules can count up to 4,294,967,296 and accept a frequency up to 3,500 Hz (without filter), so it can suitable for more applications such as production counting, button or switch ON/OFF counting, event counting... etc..

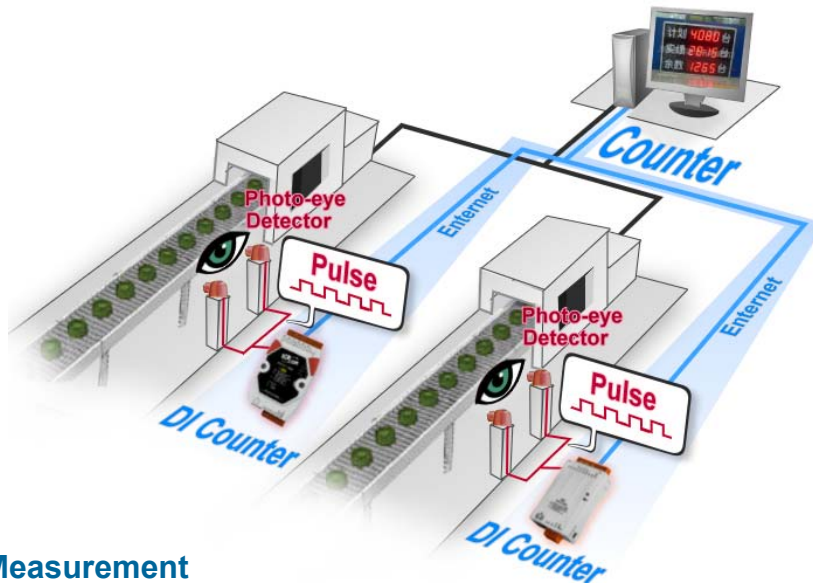

Frequency Measurement

The PETL-7000/t(P)ET module also supports frequency measurement function; it counts the DI ON/OFF changes in a certain time and then calculate the frequency automatically. Rather than polling remote DI status back and then compute the frequency in the host PC, our module can directly count out the frequency (3.5 kHz Max.) in site. This reduces the frequency errors caused by communication latency between two ends, and also reduces the network loadings. In order to applying for more applications, this module provides 3 scan modes (0.1s, 1s and single-pulse) and 4 moving average levels for user to select the best way in their applications. This feature can be used for rotation and speed measurements... etc.

Easy Network Configuration

DHCP minimizes configuration errors caused by manual IP address configuration, such as address conflicts caused by the assignment of an IP address to more than one computer or device at the same time. The PETL-7000/tET/tPET

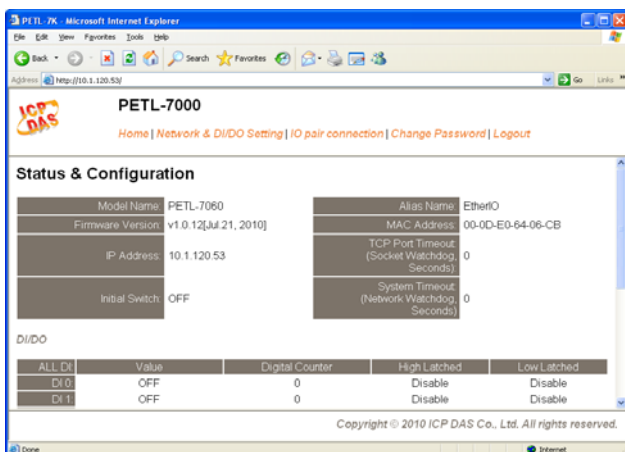

series module supports the DHCP client function, which allows the PETL-7000/tET/tPET to easily obtain the necessary TCP/IP configuration information from a DHCP server. The module also contains a UDP responder that transmits its IP address information to a UDP search from the eSearch utility program, making local management more efficient.

The series of Ethernet I/O modules features a powerful 32-bit MCU to enable efficient handling of network traffic. It also has a built-in web server that provides an intuitive web management interface to allow users to modify the settings of the module including DHCP/Static IP and gateway/mask.

Dual Watchdog with Power-on and Safe Value

The module provides dual watchdog: CPU watchdog (hardware function) and host watchdog (software function). The CPU watchdog automatically resets the CPU if the built-in firmware is operating abnormally, while the host watchdog sets the digital output with predefined safe-value when there is no communication between the module and the host (PC or PLC) for a period of time (watchdog timeout). The dual watchdog is an important feature that ensures the module operates continuously, even in harsh environments.

PoE (Power over Ethernet)



The PETL-7000/tPET series module offers true IEEE 802.3af-compliant (classification, Class 1) Power over Ethernet (PoE) using a standard category 5 Ethernet cable to receive power from a PoE switch such as the NS-205PSE. If there is no PoE switch on site, the module will also accept power input from a DC adapter. The PETL-7000/tET/tPET series is designed for ultra-low power consumption, reducing hidden costs from increasing fuel and electricity prices, especially when you have a huge amount of device servers installed. Reducing the amount of electricity consumed by choosing energy-efficient equipment can have a positive impact on maintaining a green environment.

The module is equipped with removable terminal block connectors to allow easy wiring. For maximum space savings, the tET/tPET series is offered in an amazing tiny form-factor while the PETL-7000 series is palm-size form-factor; this makes them can be easily installed in anywhere, even directly embedded into a machine.

● Applications

- Remote Maintenance
- Remote diagnosis
- Testing Equipment
- Building Automation
- Factory Automation
- Machine Automation

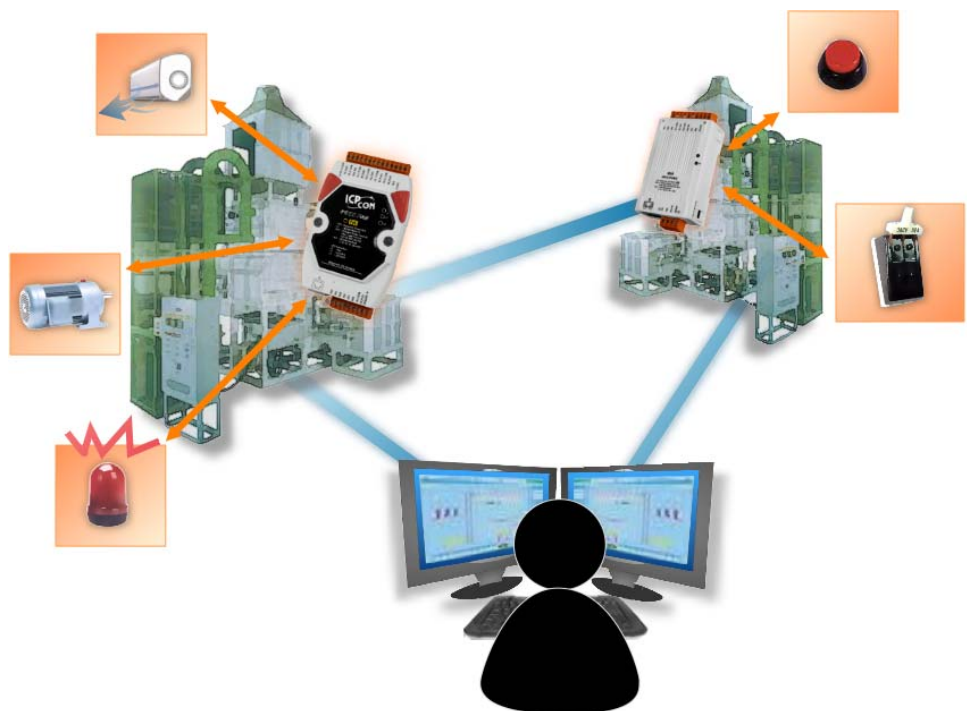



● Selection Guide



PETL-7000 Selection Guide





Digital I/O							
Model	Ethernet	DI			DO		
		Channel	Type	Sink/Source	Channel	Type	Sink/Source
PETL-7042	10/100 M, PoE	-	-	-	16	Open Collector	Sink
PETL-7044	10/100 M, PoE	8	Wet	Sink, Source	8	Open Collector	Sink
PETL-7050	10/100 M, PoE	12	Wet	Sink, Source	6	Open Collector	Sink
PETL-7051	10/100 M, PoE	16	Wet	Sink, Source	-	-	-
PETL-7052	10/100 M, PoE	8	Wet	Sink, Source	8	Open Collector	Source
PETL-7053	10/100 M, PoE	16	Dry	Source	-	-	-

Relay Output/Digital Input								
Model	Ethernet	DI			Relay Output			
		Channel	Type	Sink/Source	Channel	Relay	Type	Max. Load Current
PETL-7060	10/100 M, PoE	6	Wet	Sink, Source	6	Power Relay	Form A (SPST N.O.)	5.0 A/channel
PETL-7065	10/100 M, PoE	6	Wet	Sink, Source	6	PhotoMOS Relay	Form A (SPST N.O.)	1.0 A/channel
PETL-7066	10/100 M, PoE	-	-	-	8	PhotoMOS Relay	Form A (SPST N.O.)	1.0 A/channel
PETL-7067	10/100 M, PoE	-	-	-	8	Power Relay	Form A (SPST N.O.)	5.0 A/channel



Features

- Cost-effective Ethernet I/O modules (Modbus TCP/UDP)
- Contains a 32-bit MCU that efficiently handles network traffic
- 10/100 Base-TX Ethernet, RJ-45 x1 (Auto-negotiating, Auto MDI/MDIX, LED Indicator)
- Includes redundant power inputs: PoE and DC input
- Supports TCP, UDP, HTTP, DHCP, BOOTP and TFTP protocols
- Supports UDP responder for device discovery
- Supports web configuration and firmware update via Ethernet
- Supports PWM (Pulse Width Modulation) in DO channels
- Supports latched DI and 32-bit high-speed counter functions
- Supports I/O pair-connection through the Ethernet
- Dual-watchdog with power-on and safe value
- Easy DIN-Rail mounting
- RoHS compliant & no Halogen
- Made from fire retardant materials (UL94-V0 Level)
- Low power consumption (about 1.7 W only)













System Specifications

Moduls	PETL-7042/7044/7050/7051/7052/7053/7060/7065/7066/7067
System	
CPU	32-bit MCU
Dual Watchdog	Yes
Communication	
Ethernet Port	10/100 Base-TX, 8-Pin RJ-45 x1, (Auto-negotiating, Auto-MDI/MDIX, LED indicator) PoE (IEEE 802.3af, Class 1)
LED Display	
PoE	PoE indicator
L1	Run indicator
L2	Link/Act indicator
L3	10/100 M indicator
Mechanical	
Dimensions	123 mm x 72 mm x 35 mm
Installation	DIN-Rail or Wall mounting
Environment	
Operating Temperature	-25 °C ~ +75 °C
Storage Temperature	-30 °C ~ +80 °C
Humidity	10 ~ 90 % RH, non-condensing
Power Requirements	
Power Input	PoE: IEEE 802.3af, Class 1 Terminal block: +12 ~ 48 V _{DC} (non-regulated)
Power Consumption	0.05 A @ 48 V _{DC} Max. for PETL-7060

I/O Specifications



Digital Input/Output Series



Models			
	PETL-7042	PETL-7044	PETL-7050
Digital Input			
Input Channels	-	8	12
Input Type (Device)	-	Wet Contact (Sink, Source)	
On Voltage Level	-	+10 V _{DC} ~ +50 V _{DC}	
Off Voltage Level	-	+4 V _{DC} max.	
Input Impedance	-	10 k Ohm	
Counters	-	Max. Count: 4,294,967,285 (32 bits)	
	-	Max. Input Frequency: 3.5 kHz (without filter)	
	-	Min. Pulse Width: 0.15 ms	
Frequency Measurement	-	3.5 kHz in Mode "1000 ms" (+/-1 Hz error)	
Overvoltage Protection	-	+70 V _{DC}	
Isolation	-	3750 Vrms	
Digital Output			
Output Channels	16	8	6
Output Type (Module)	Sink, Open Collector		
Output Voltage	+5 V _{DC} ~ +30 V _{DC}	+10 V _{DC} ~ +40 V _{DC}	+5 V _{DC} ~ +30 V _{DC}
Max. Load Current	100 mA/channel at 25 °C	300 mA/channel at 25 °C	100 mA/channel at 25 °C
PWM	100 Hz Max. (High/Low duty cycle range = 5 ~ 65,535 ms)		
Short Circuit Protection	Yes		
Output Isolation	3750 Vrms		

Models			
	PETL-7051	PETL-7052	PETL-7053
Digital Input			
Input Channels	16	8	16
Input Type (Device)	Wet Contact (Sink, Source)		Dry Contact
On Voltage Level	+10 V _{DC} ~ +50 V _{DC}		Open
Off Voltage Level	+4 V _{DC} max.		Close to GND
Input Impedance	10 k Ohm		
Counters	Max. Count: 4,294,967,285 (32 bits)		
	Max. Input Frequency: 3.5 kHz (without filter)		
	Min. Pulse Width: 0.15 ms		
Frequency Measurement	3.5 kHz in Mode "1000 ms" (+/-1 Hz error)		
Overvoltage Protection	+70 V _{DC}	-	-
Effective Distance	-	-	500 m max.
Isolation	3750 Vrms		
Digital Output			
Output Channels	-	8	-
Output Type (Module)	-	Source, Open Collector	-
Output Voltage	-	+10 V _{DC} ~ +40 V _{DC}	-
Max. Load Current	-	650 mA/channel at 25 °C	-
PWM	-	100 Hz Max. (High/Low duty cycle range= 5 ~ 65,535 ms)	-
Overvoltage Protection	-	+48 V _{DC}	-
Output Isolation	-	3750 Vrms	-

Ethernet I/O Module

Digital Input/Relay Output Series

Models			
		PETL-7060	PETL-7067
Digital Input			
Input Channels	6	-	-
Input Type (Device)	Wet Contact (Sink, Source)	-	-
On Voltage Level	+10 V _{DC} ~ +50 V _{DC}	-	-
Off Voltage Level	+4 V _{DC} max.	-	-
Input Impedance	10 k Ohm	-	-
Counters	Max. Count: 4,294,967,285 (32 bits)	-	-
	Max. Input Frequency: 3.5 kHz (without filter)	-	-
	Min. Pulse Width: 0.15 ms	-	-
Frequency Measurement	3.5 kHz in Mode "1000 ms" (+/-1 Hz error)	-	-
Overvoltage Protection	+70 V _{DC}	-	-
Isolation	3750 Vrms	-	-
Relay Output			
Output Channels	6	8	
Output Type (Module)	Power Relay, Form A (SPST N.O.)		
Output Voltage Range	250 V _{AC} /30 V _{DC}		
Max. Load Current	5.0 A/channel at 25 °C		
Operate Time	6 ms		
Release Time	4 ms		
PWM	50 Hz Max. (High/Low duty cycle range = 10 ~ 65,535 ms)		
Electrical Life (Resistive load)	VED	5 A 250 V _{AC} 30,000 ops (10 ops/minute) at 75 °C	
		5 A 30 V _{DC} 70,000 ops (10 ops/minute) at 75 °C	
	UL	5 A 250 V _{AC} /30 V _{DC} 6,000 ops	
		3 A 250 V _{AC} /30 V _{DC} 100,000 ops	
Mechanical Life	20,000,000 ops. At no load (300 ops./ minute)		
Relay Output Isolation	3000 Vrms		

Models			
		PETL-7065	PETL-7066
Digital Input			
Input Channels	6	-	-
Input Type (Device)	Wet Contact (Sink, Source)	-	-
On Voltage Level	+10 V _{DC} ~ +50 V _{DC}	-	-
Off Voltage Level	+4 V _{DC} max.	-	-
Input Impedance	10 k Ohm	-	-
Counters	Max. Count: 4,294,967,285 (32 bits)	-	-
	Max. Input Frequency: 3.5 kHz (without filter)	-	-
	Min. Pulse Width: 0.15 ms	-	-
Frequency Measurement	3.5 kHz in Mode "1000 ms" (+/-1 Hz error)	-	-
Overvoltage Protection	+70 V _{DC}	-	-
Isolation	3750 Vrms	-	-
Relay Output			
Output Channels	6	8	
Output Type (Module)	PhotoMOS Relay, Form A		
Load Voltage	60 V _{DC} / V _{AC}		
Load Current	60 V/1.0 A (Operating Temperature -25°C ~ -40°C)		
	60 V/0.8 A (Operating Temperature +40°C ~ +60°C)		
	60 V/0.7 A (Operating Temperature +60°C ~ +75°C)		
PWM	50 Hz Max. (High/Low duty cycle range = 10 ~ 65,535 ms)		
Turn ON Time	1.3 ms (Typical)		
Turn Off Time	0.1 ms (Typical)		
Relay Output Isolation	3000 Vrms		

Pin Assignments

Digital Input/Output Series

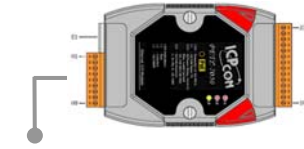

PETL-7042	
E1	RJ-45
01	DO12
02	DO13
03	DO14
04	DO15
05	DO.PWR2
06	DO.GND2
07	N/A
08	(R)+Vs
09	(B)GND

PETL-7042	
23	DO11
22	DO10
21	DO9
20	DO8
19	DO7
18	DO6
17	DO5
16	DO4
15	DO3
14	DO2
13	DO1
12	DO0
11	DO.GND1
10	DO.PWR1



PETL-7044	
E1	RJ-45
01	DI3
02	DI4
03	DI5
04	DI6
05	DI7
06	DI.COM2
07	N/A
08	(R)+Vs
09	(B)GND

PETL-7044	
23	DI2
22	DI1
21	DI0
20	DI.COM1
19	DO7
18	DO6
17	DO5
16	DO4
15	DO3
14	DO2
13	DO1
12	DO0
11	DO.GND
10	DO.PWR

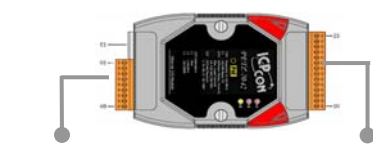

PETL-7050	
E1	RJ-45
01	DI6
02	DI7
03	DI8
04	DI9
05	DI10
06	DI11
07	DI.COM
08	(R)+Vs
09	(B)GND

PETL-7050	
23	DI5
22	DI4
21	DI3
20	DI2
19	DI1
18	DI0
17	DO5
16	DO4
15	DO3
14	DO2
13	DO1
12	DO0
11	DO.GND
10	DO.PWR

PETL-7051	
E1	RJ-45
01	DI13
02	DI14
03	DI15
04	DI.COM2
05	N/A
06	N/A
07	N/A
08	(R)+Vs
09	(B)GND

PETL-7051	
23	DI12
22	DI11
21	DI10
20	DI9
19	DI8
18	DI.COM1
17	DI7
16	DI6
15	DI5
14	DI4
13	DI3
12	DI2
11	DI1
10	DI0

PETL-7052	
E1	RJ-45
01	DI3
02	DI4
03	DI5
04	DI6
05	DI7
06	DI.COM2
07	N/A
08	(R)+Vs
09	(B)GND

PETL-7052	
23	DI2
22	DI1
21	DI0
20	DI.COM1
19	DO7
18	DO6
17	DO5
16	DO4
15	DO3
14	DO2
13	DO1
12	DO0
11	DO.GND
10	DO.PWR

PETL-7053	
E1	RJ-45
01	DI13
02	DI14
03	DI15
04	DI.GND2
05	N/A
06	N/A
07	N/A
08	(R)+Vs
09	(B)GND

PETL-7053	
23	DI12
22	DI11
21	DI10
20	DI9
19	DI8
18	DI7
17	DI6
16	DI5
15	DI4
14	DI3
13	DI2
12	DI1
11	DI0
10	DI.GND1

Digital Input/Relay Output Series



PETL-7060 PETL-7065	
E1	RJ-45
01	DI5
02	DI4
03	DI3
04	DI2
05	DI1
06	DI0
07	DI.COM
08	(R)+Vs
09	(B)GND

PETL-7060 PETL-7065	
23	RL5 COM
22	RL5 NO
21	RL4 COM
20	RL4 NO
19	RL3 COM
18	RL3 NO
17	RL2 COM
16	RL2 NO
15	RL1 COM
14	RL1 NO
13	RLO COM
12	RLO NO
11	N/A
10	N/A

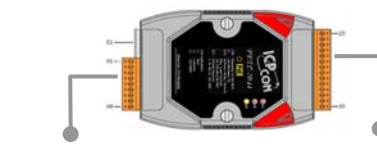

PETL-7066 PETL-7067	
E1	RJ-45
01	RL6 NO
02	RL6 COM
03	RL7 NO
04	RL7 COM
05	N/A
06	N/A
07	N/A
08	(R)+Vs
09	(B)GND

PETL-7066 PETL-7067	
23	RL5 COM
22	RL5 NO
21	RL4 COM
20	RL4 NO
19	RL3 COM
18	RL3 NO
17	RL2 COM
16	RL2 NO
15	RL1 COM
14	RL1 NO
13	RLO COM
12	RLO NO
11	N/A
10	N/A

Dimensions (Unit:mm)

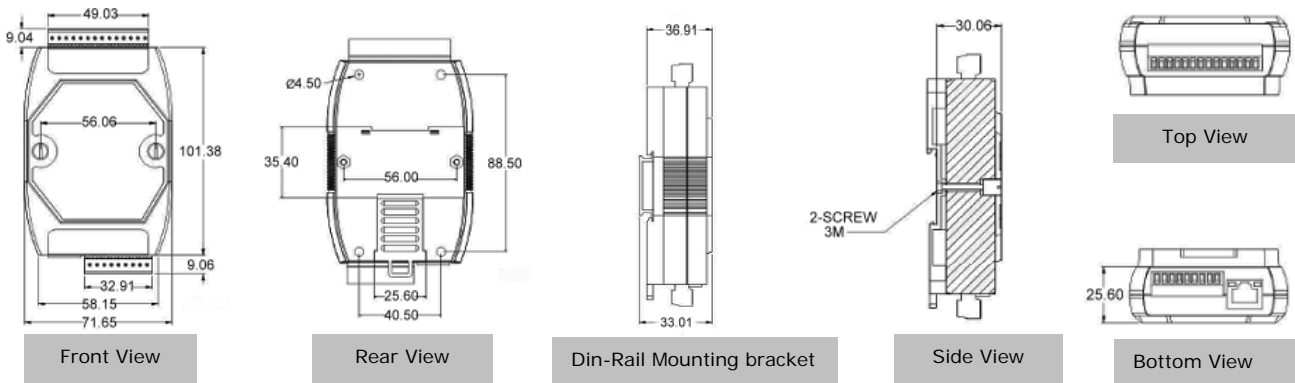

Ordering Information

PETL-7042 CR (Available soon)	Ethernet module with PoE and 16-ch isolated open collector (sink) DO (RoHS)
PETL-7044 CR (Available soon)	Ethernet module with PoE, 8-ch isolated DI and 8-ch Isolated open collector (sink) DO (RoHS)
PETL-7050 CR (Available soon)	Ethernet module with PoE, 12-ch isolated DI and 6-ch isolated open collector (sink) DO (RoHS)
PETL-7051 CR (Available soon)	Ethernet module with PoE and 16-ch isolated DI (RoHS)
PETL-7052 CR (Available soon)	Ethernet module with PoE, 8-ch isolated DI and 8-ch open collector (source) DO (RoHS)
PETL-7053 CR (Available soon)	Ethernet module with PoE and 16-ch isolated dry-contact DI (RoHS)
PETL-7060 CR (NEW)	Ethernet module with PoE, 6-ch isolated DI and 6-ch Form A power relay (RoHS)
PETL-7065 CR (Available soon)	Ethernet module with PoE, 6-ch isolated DI and 6-ch PhotoMOS relay (RoHS)
PETL-7066 CR (Available soon)	Ethernet module with PoE and 8-ch PhotoMOS relay (RoHS)
PETL-7067 CR (Available soon)	Ethernet module with PoE and 8-ch Form A power relay (RoHS)

Accessories

NS-205 CR	Unmanaged 5-Port Industrial Ethernet Switch (RoHS)
NS-205PSE CR	Unmanaged Ethernet Switch with 4 PoE Ports and 1 RJ-45 Uplink (RoHS)
NS-205PSE-24V CR	Unmanaged 5-Port 10/100 Mbps PoE (PSE) Ethernet Switch; 24 Vdc Input (RoHS)
DIN-KA52F CR	24 V/1.04 A, 25 W Power Supply with DIN-Rail Mounting (RoHS)
DIN-KA52F-48 CR	48 V/0.52 A, 25 W Power Supply with Din-Rail Mounting (RoHS, for NS-205PSE)
GPSU06U-6	24 V/0.25 A (max) Power Supply



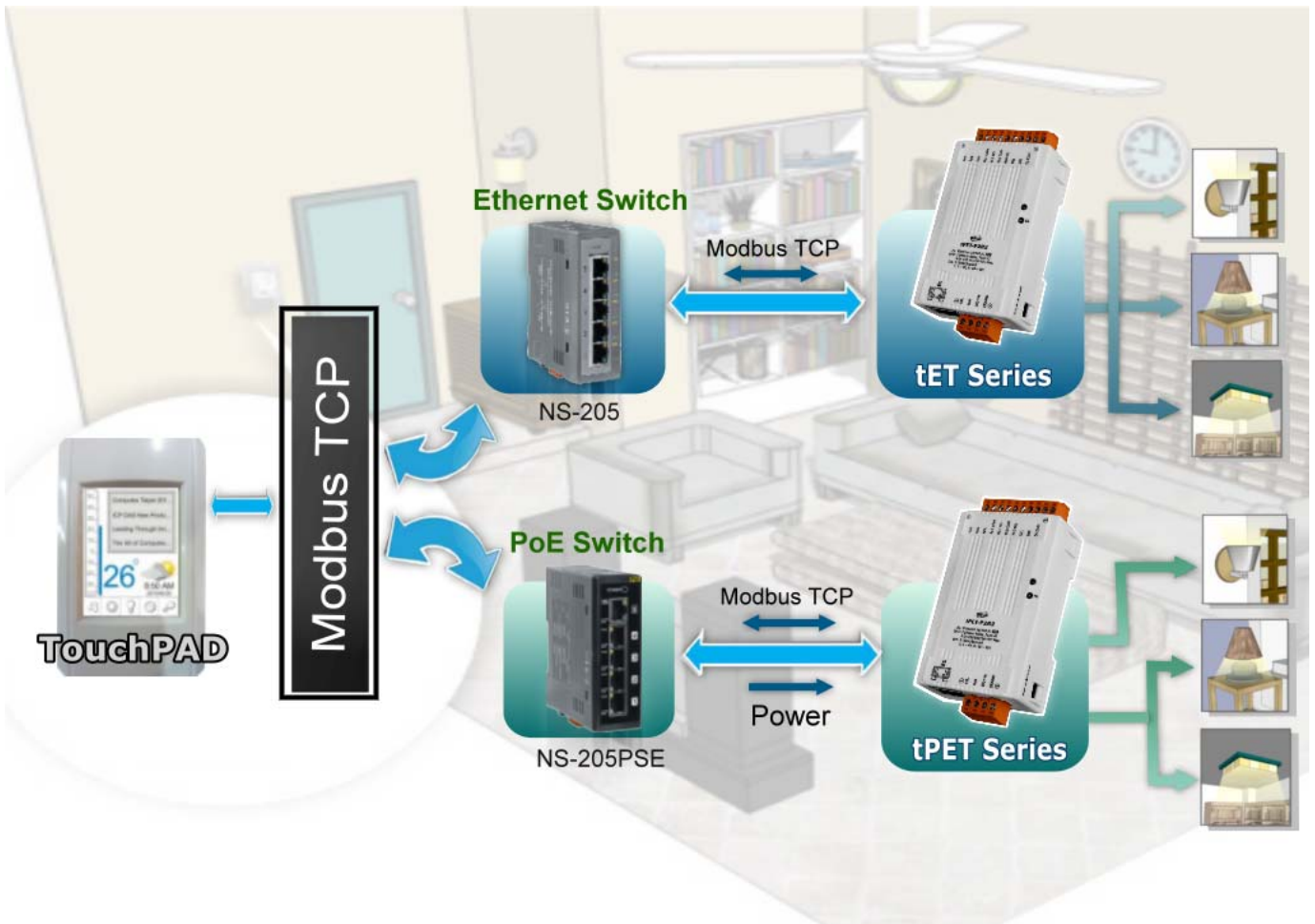

● Selection Guide



tET/tPET Selection Guide

Model Name		Bus	Protocol	I/O Specification		
Ethernet	PoE			Isolation	DI	DO
tET-P6	tPET-P6	Ethernet 10/100 M	Modbus TCP/UDP	Yes	6-ch (Sink/Source)	-
tET-C4	tPET-C4			Yes	-	4-ch (NPN, Sink)
tET-A4	tPET-A4			Yes	-	4-ch (PNP, Source)
tET-P2C2	tPET-P2C2			Yes	2-ch (Sink/Source)	2-ch (NPN, Sink)
tET-P2A2	tPET-P2A2			Yes	2-ch (Sink/Source)	2-ch (PNP, Source)
tET-P2POR2	tPET-P2POR2			Yes	2-ch (Sink/Source)	2-ch Form A PhotoMos Relay
tET-P2R2	tPET-P2R2			Yes	2-ch (Sink/Source)	2-ch Form A Power Relay



Available soon
tET/tPET Series
 Tiny Ethernet I/O modules

Features

- Cost-effective tiny Ethernet I/O modules (Modbus TCP/UDP)
- Contains a 32-bit MCU that efficiently handles network traffic
- 10/100 Base-TX Ethernet, RJ-45 x1 (Auto-negotiating, auto MDI/MDIX, LED Indicators)
- Includes redundant power inputs: PoE and DC input
- Supports TCP, UDP, HTTP, DHCP, BOOTP and TFTP protocols
- Supports UDP responder for device discovery
- Supports web configuration and firmware update via Ethernet
- Supports PWM (Pulse Width Modulation) in DO channels
- Supports latched D/I and 32-bit low-speed counter functions
- Supports I/O pair-connection through the Ethernet
- Dual-watchdog with power-on and safe value
- Tiny form-factor with easy DIN-Rail mounting
- RoHS compliant & no Halogen
- Made from fire retardant materials (UL94-V0 Level)
- Low power consumption (about 1.7 W only)







System Specifications

Moduls	tET Series	tPET Series
System		
CPU	32-bit MCU	
Dual Watchdog	Yes	
Communication		
Ethernet Port	10/100 Base-TX, 8-Pin RJ-45 x1, (Auto-negotiating, Auto-MDI/MDIX, LED indicator)	
	-	PoE (IEEE 802.3af, Class 1)
LED Display		
S1	-	
	System indicator (Red)	
E1	Link/Act indicator (Green)	
	10/100 M indicator (Yellow)	
Mechanical		
Dimensions	52 mm x 27 mm x 98 mm	
Installation	DIN-Rail mounting	
Environment		
Operating Temperature	-25 °C ~ +75 °C	
Storage Temperature	-30 °C ~ +80 °C	
Humidity	10 ~ 90 % RH, non-condensing	
Power Requirements		
Power Input	-	
	Terminal block: +12 ~ 48 V _{DC} (non-regulated)	
Power Consumption	0.04 A @ 24 V _{DC} for tET-P2R2	0.03 A @ 48 V _{DC} for tPET-P2R2



I/O Specifications

Digital Input/Output Series

Models				
	tET-C4/tPET-C4		tET-A4/tPET-A4	
Digital Output				
Output Channels	4			
Output Type (Module)	Sink, Open Collector (NPN)		Source, Open Collector (PNP)	
Output Voltage	+5 V _{DC} ~ +30 V _{DC}		+10 V _{DC} ~ +40 V _{DC}	
Max. Load Current	100 mA/channel at 25 °C Direct drive power relay module		650 mA/channel at 25 °C	
PWM	100 Hz Max. (High/Low duty cycle range = 5 ~ 65,535 ms)			
Over-Voltage	+60 V _{DC}		+48 V _{DC}	
Short Circuit Protection	-		Yes	
Output Isolation	3750 Vrms			

Models						
	tET-P6/tPET-P6		tET-P2C2/tPET-P2C2		tET-P2A2/tPET-P2A2	
Digital Input						
Input Channels	6		2			
Input Type (Device)	Wet Contact (Sink, Source)					
On Voltage Level	+10 V _{DC} ~ +50 V _{DC}					
Off Voltage Level	+4 V _{DC} max.					
Input Impedance	10 k Ohm					
Counters	Max. Count: 4,294,967,285 (32 bits)					
	Max. Input Frequency: 3.5 kHz (without filter)					
	Min. Pulse Width: 0.15 ms					
Frequency Measurement	3.5 kHz in Mode "1000 ms" (+/-1 Hz error)					
Overvoltage Protection	+70 V _{DC}					
Isolation	3750 Vrms					
Digital Output						
Output Channels	-		2			
Output Type (Module)	-		Sink, Open Collector (NPN)		Source, Open Collector (PNP)	
Output Voltage	-		+5 V _{DC} ~ +30 V _{DC}		+10 V _{DC} ~ +40 V _{DC}	
Max. Load Current	-		100 mA/channel at 25 °C Direct drive power relay module		650 mA/channel at 25 °C	
PWM	100 Hz Max. (High/Low duty cycle range = 5 ~ 65,535 ms)					
Over-Voltage	-		+60 V _{DC}		+48 V _{DC}	
Short Circuit Protection	-		-		Yes	
Output Isolation	-		3750 Vrms			

Digital Input/Relay Output Series

Models				
	tET-P2POR2/tPET-P2POR2		tET-P2R2/tPET-P2R2	
Digital Input				
Input Channels	2			
Input Type (Device)	Wet Contact (Sink, Source)			
On Voltage Level	+10 V _{DC} ~ +50 V _{DC}			
Off Voltage Level	+4 V _{DC} Max.			
Input Impedance	10 k Ohm			
Counters	Max. Count: 4,294,967,285 (32 bits)			
	Max. Input Frequency: 3.5 kHz (without filter)			
	Min. Pulse Width: 0.15 ms			
Frequency Measurement	3.5 kHz in Mode "1000 ms" (+/-1 Hz error)			
Overtoltage Protection	+70 V _{DC}			
Isolation	3750 Vrms			
Relay Output				
Output Channels	2		2	
Output Type (Module)	PhotoMOS Relay, Form A		Power Relay, Form A (SPST N.O.)	
Load Voltage	60 V _{DC} / V _{AC}		-	
Load Current	60 V/1.0 A (Operating Temperature -25°C ~ -40°C)		-	
	60 V/0.8 A (Operating Temperature +40°C ~ +60°C)		-	
	60 V/0.7 A (Operating Temperature +60°C ~ +75°C)		-	
Turn ON Time	1.3 ms (Typical)		-	
Turn Off Time	0.1 ms (Typical)		-	
Output Isolation	3000 Vrms		3000 Vrms	
Output Voltage Range	-		250 V _{AC} /30 V _{DC}	
Max. Load Current	-		5.0 A/channel at 25 °C	
Operate Time	-		6 ms	
Release Time	-		3 ms	
PWM	50 Hz Max. (High/Low duty cycle range= 10 ~ 65,535 ms)			
Electrical Life (Resistive load)	VED	-		5 A 250 V _{AC} 30,000 ops (10 ops/minute) at 75 °C
		-		5 A 30 V _{DC} 70,000 ops (10 ops/minute) at 75 °C
	UL	-		5 A 250 V _{AC} /30 V _{DC} 6,000 ops
		-		3 A 250 V _{AC} /30 V _{DC} 100,000 ops
Mechanical Life	-			

Pin Assignments

tET/tPET-C4 tET/tPET-A4	
E1	Link/Act 10/100 M
01	F.G.
02	N/A
03	(R)+Vs
04	(B)GND

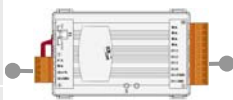

tET/tPET-C4 tET/tPET-A4	
14	N/A
13	N/A
12	N/A
11	N/A
10	DO3
09	DO2
08	DO1
07	DO0
06	DO.PWR
05	DO.GND

tET/tPET-P6	
E1	Link/Act 10/100 M
01	F.G.
02	N/A
03	(R)+Vs
04	(B)GND

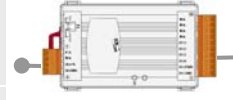

tET/tPET-P6	
14	N/A
13	N/A
12	N/A
11	DI5
10	DI4
09	DI3
08	DI2
07	DI1
06	DI0
05	DI.COM

tET/tPET-P2C2 tET/tPET-P2A2	
E1	Link/Act 10/100 M
01	F.G.
02	N/A
03	(R)+Vs
04	(B)GND

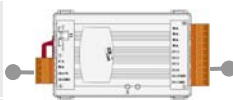

tET/tPET-P2C2 tET/tPET-P2A2	
14	N/A
13	N/A
12	N/A
11	DI1
10	DI0
09	DI.COM
08	DO1
07	DO0
06	DO.PWR
05	DO.GND

tET/tPET-P2POR2 tET/tPET-P2R2	
E1	Link/Act 10/100 M
01	F.G.
02	N/A
03	(R)+Vs
04	(B)GND

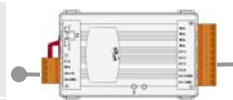

tET/tPET-P2POR2 tET/tPET-P2R2	
14	N/A
13	N/A
12	N/A
11	RL1 COM
10	RL1 NO
09	RL0 COM
08	RL0 NO
07	DI1
06	DI0
05	DI.COM

Dimensions (Unit: mm)

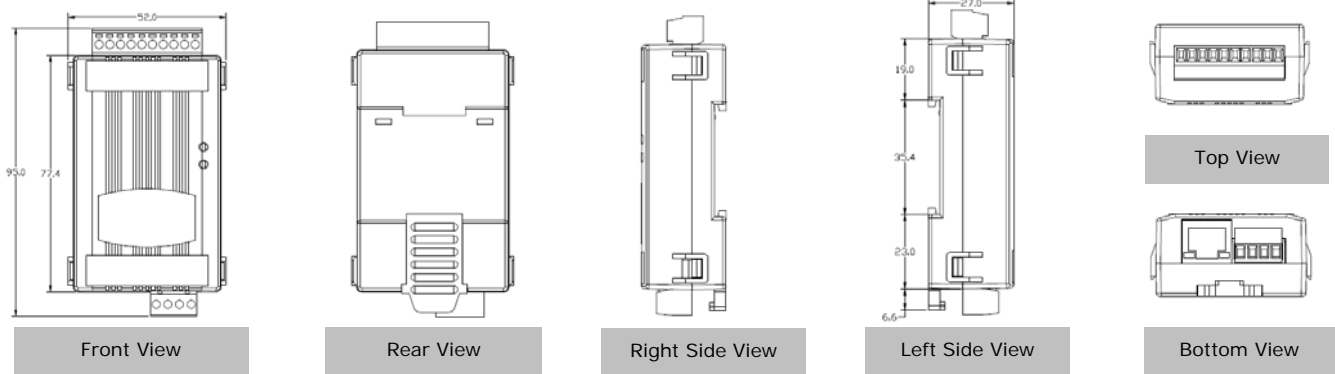

Ordering Information

tET Series	
tET-P6 CR (Available soon)	Tiny Ethernet module with 6-ch DI (RoHS)
tET-C4 CR (Available soon)	Tiny Ethernet module with 4-ch DO (NPN, Sink) (RoHS)
tET-A4 CR (Available soon)	Tiny Ethernet module with 4-ch DO (PNP, Source) (RoHS)
tET-P2C2 CR (Available soon)	Tiny Ethernet module with 2-ch DI and 2-ch DO (NPN, Sink) (RoHS)
tET-P2A2 CR (Available soon)	Tiny Ethernet module with 2-ch DI and 2-ch DO (PNP, Source) (RoHS)
tET-P2POR2 CR (Available soon)	Tiny Ethernet module with 2-ch DI and 2-ch Form A PhotoMos relay (RoHS)
tET-P2R2 CR (New)	Tiny Ethernet module with 2-ch DI and 2-ch Form A relay (RoHS)
tPET Series	
tPET-P6 CR (Available soon)	Tiny Ethernet module with PoE, and 6-ch DI (RoHS)
tPET-C4 CR (Available soon)	Tiny Ethernet module with PoE, and 4-ch DO (NPN, Sink) (RoHS)
tPET-A4 CR (Available soon)	Tiny Ethernet module with PoE, and 4-ch DO (PNP, Source) (RoHS)
tPET-P2C2 CR (Available soon)	Tiny Ethernet module with PoE, 2-ch DI and 2-ch DO (NPN, Sink) (RoHS)
tPET-P2A2 CR (Available soon)	Tiny Ethernet module with PoE, 2-ch DI and 2-ch DO (PNP, Source) (RoHS)
tPET-P2POR2 CR (Available soon)	Tiny Ethernet module with PoE, 2-ch DI and 2-ch Form A PhotoMos relay (RoHS)
tPET-P2R2 CR (New)	Tiny Ethernet module with PoE, 2-ch DI and 2-ch Form A power relay (RoHS)

Accessories

NS-205 CR	Unmanaged 5-Port Industrial Ethernet Switch (RoHS)
NS-205PSE CR	Unmanaged Ethernet Switch with 4 PoE Ports and 1 RJ-45 Uplink (RoHS)
NS-205PSE-24V CR	Unmanaged 5-Port 10/100 Mbps PoE (PSE) Ethernet Switch; 24 Vdc Input (RoHS)
DIN-KA52F CR	24 V/1.04 A, 25 W Power Supply with DIN-Rail Mounting (RoHS)
DIN-KA52F-48 CR	48 V/0.52 A, 25 W Power Supply with Din-Rail Mounting (RoHS, for NS-205PSE)
GPSU06U-6	24 V/0.25 A (max) Power Supply



NS-205 CR



NS-205PSE CR



NS-205PSE-24V CR



DIN-KA52F CR



DIN-KA52F-48 CR



GPSU06U-6

1 HMI and TouchPAD control (Poll) Remote DIO (modules)

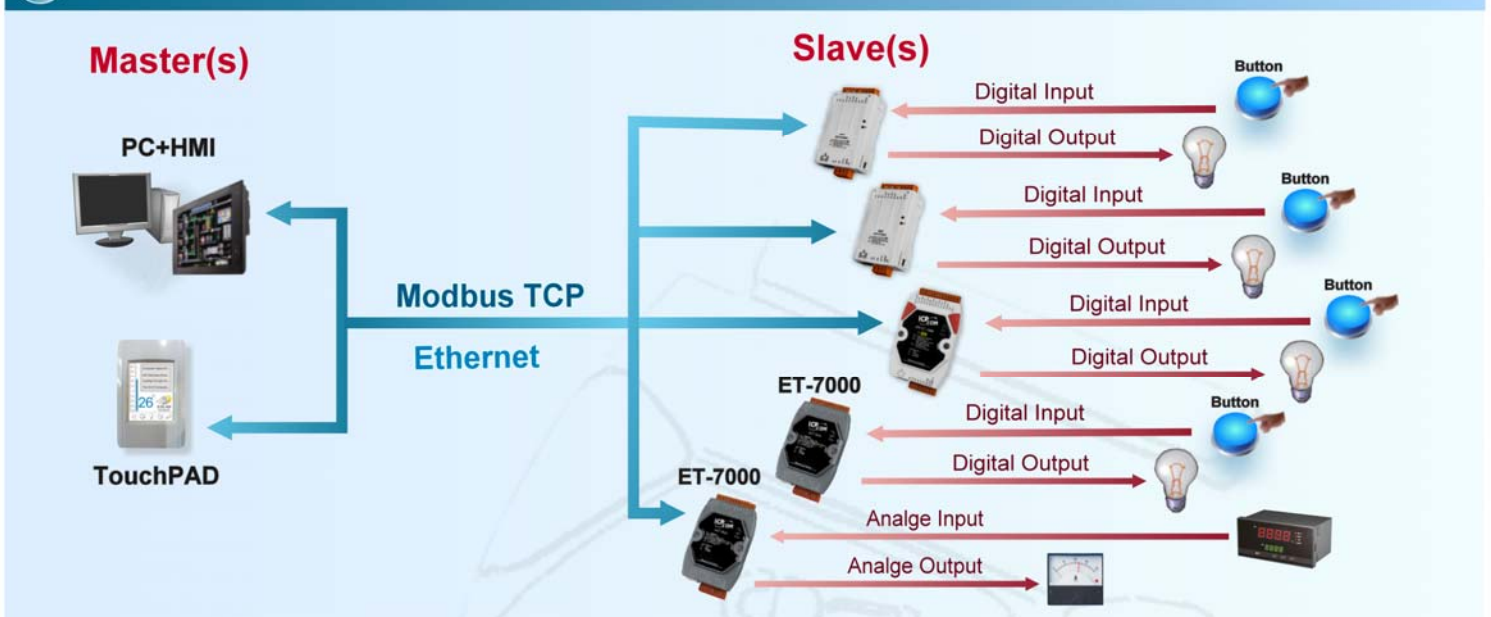

2 Module Pushes DI to Remote DO (Module or PLC)

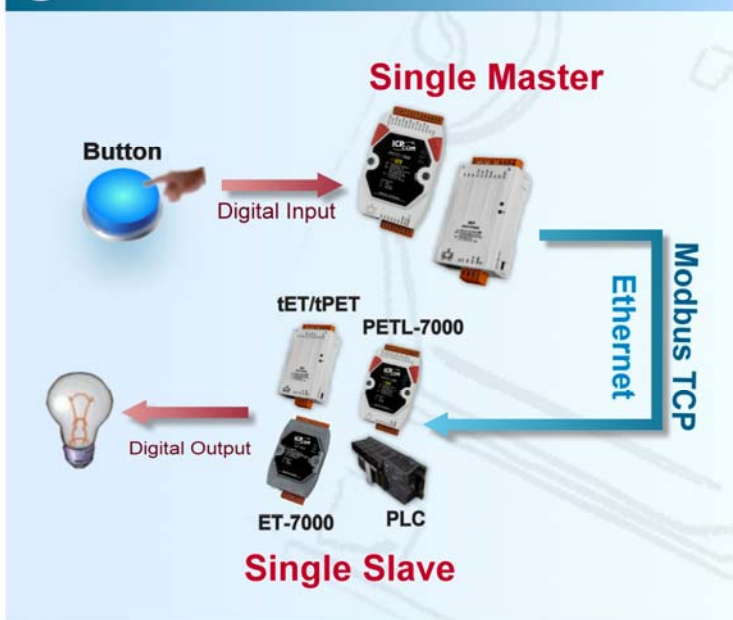

3 Multiple Modules Push DI to Remote DO (HMI or ET-7000)

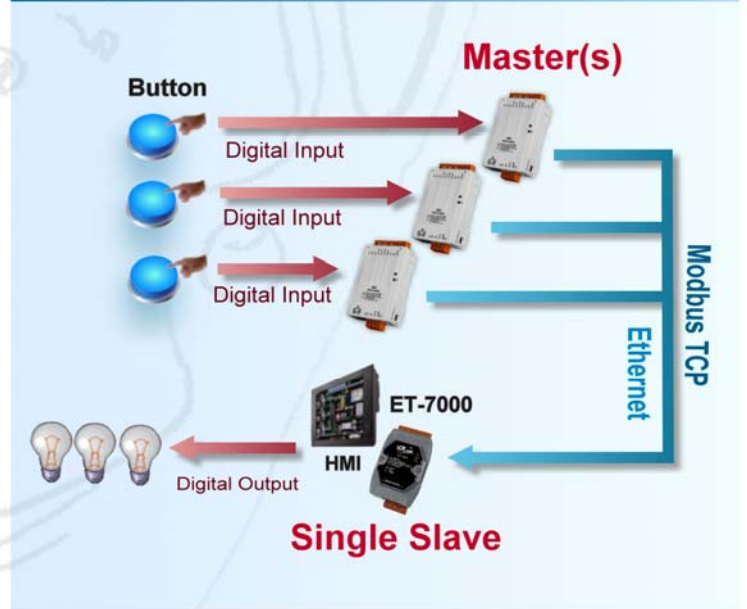

4 Push DI to Remote DO

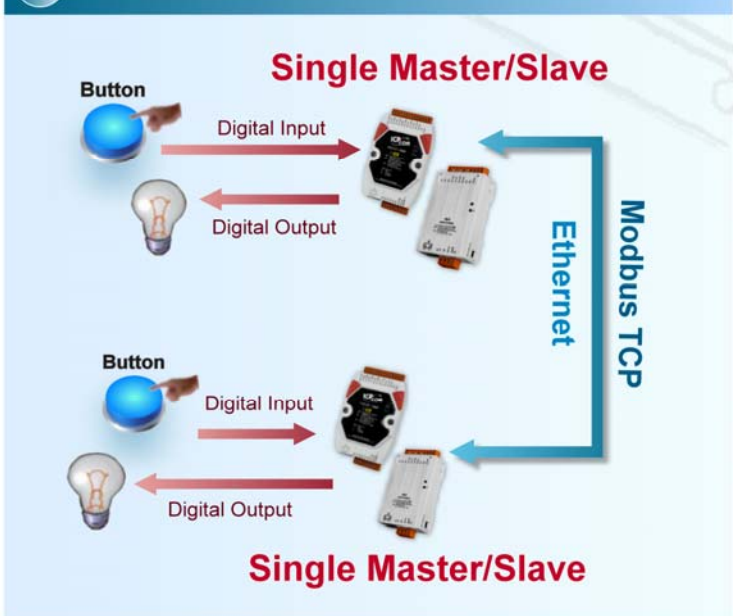

5 Multiple Modules Read/Write (Poll) DIO from/to Remote HMI/ET-7000

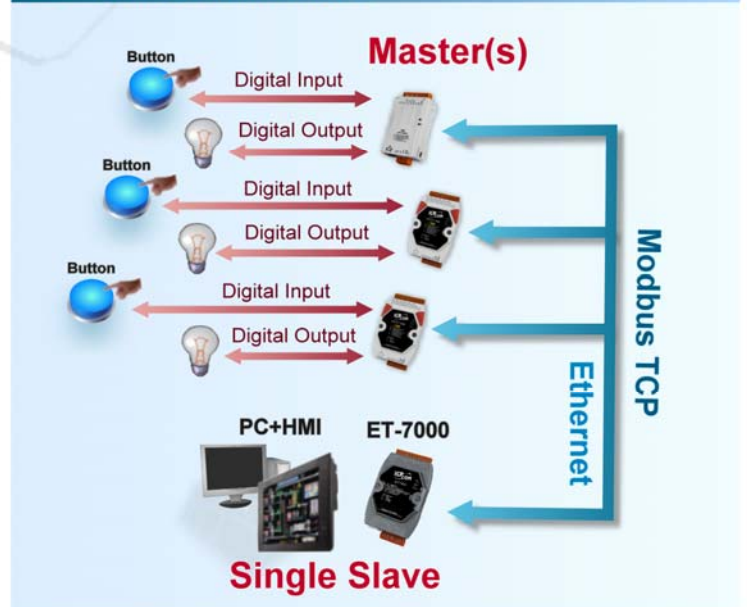

ICP DAS CO., LTD

Taiwan

Website: <http://www.icpdas.com>

E-mail: sales@icpdas.com

TEL: 886-3-597-3366 FAX: 886-3-597-3733

China

Website: <http://www.icpdas.com.cn>

E-mail: sales_sh@icpdas.com.cn

TEL: 86-21-6247-1722 FAX: 86-21-6247-1725

Europe

Website: <http://www.icpdas-europe.com>

E-mail: info@icpdas-europe.com

TEL: +49(0)7121-14324-0 FAX: +49(0)7121-14324-90

USA

Website: <http://www.icpdas-usa.com>

E-mail: sales@icpdas-usa.com

TEL: 1-310-517-9888 x101 FAX: 1-310-517-0998

Local Distributor