

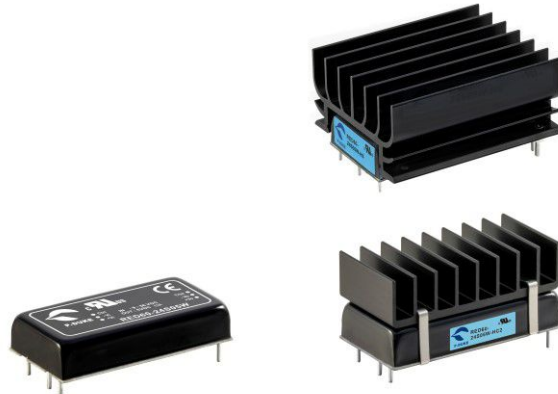

3
YEARS
WARRANTY

ROHS
COMPLIANT

REACH
COMPLIANT



Railway



Automation



Datacom



IPC



Industry



Measurement



Telecom



Automobile



Boat



Charger



Medical



PV



3000
VDC
Isolation
Voltage

4 : 1
Wide
Input
Range

6
sided
Shielding

LOW
Standby
Power

NO
Min. Load
Required

REMOTE
ON
OFF

OCP

OTP

OVP

SCP

UVP

PART NUMBER STRUCTURE

RED60 - **48** **S** **05** **W** - **N** **HS**

Series Name

Input
Voltage
(VDC)

Output
Quantity

Output
Voltage
(VDC)

Input
Range

Remote On/Off
Options

Assembly
Options

24: 9~36
48: 18~75
110: 36~160

S: Single

3P3: 3.3
05: 5
5P1: 5.1
12: 12
15: 15
24: 24
48: 48
53: 53

4:1

□: Positive logic
N: Negative logic

□: None

HS: 7G-0110A-F
HC1: 7GA0120P01-F; H=0.3"
HC2: 7GA0121P01-F; H=0.5"
HC3: 7GA0122P01-F; H=0.8"

D: Dual

12: ±12
15: ±15
24: ±24

TECHNICAL SPECIFICATION All specifications are typical at nominal input, full load and 25°C unless otherwise noted

Model Number	Input Range	Output Voltage	Output Current @ Full Load	Input Current @ No Load	Efficiency	Maximum Capacitor Load
	VDC	VDC	A	mA	%	μF
RED60-24S3P3W	9 ~ 36	3.3	18.2	15	88	26000
RED60-24S05W	9 ~ 36	5	12	15	91	17000
RED60-24S5P1W	9 ~ 36	5.1	12	15	91	17000
RED60-24S12W	9 ~ 36	12	5	15	93	3000
RED60-24S15W	9 ~ 36	15	4	15	93	1900
RED60-24S24W	9 ~ 36	24	2.5	15	90.5	730
RED60-24S48W	9 ~ 36	48	1.25	20	91.5	190
RED60-24S53W	9 ~ 36	53	1.14	20	91.5	150
RED60-24D12W	9 ~ 36	±12	±2.5	20	90.5	±1500
RED60-24D15W	9 ~ 36	±15	±2	20	90.5	±940
RED60-24D24W	9 ~ 36	±24	±1.25	20	91.5	±370
RED60-48S3P3W	18 ~ 75	3.3	18.2	10	89	26000
RED60-48S05W	18 ~ 75	5	12	10	91.5	17000
RED60-48S5P1W	18 ~ 75	5.1	12	10	91.5	17000
RED60-48S12W	18 ~ 75	12	5	10	92.5	3000
RED60-48S15W	18 ~ 75	15	4	10	94	1900
RED60-48S24W	18 ~ 75	24	2.5	10	91.5	730
RED60-48S48W	18 ~ 75	48	1.25	20	92	190
RED60-48S53W	18 ~ 75	53	1.14	20	92	150
RED60-48D12W	18 ~ 75	±12	±2.5	20	91.5	±1500
RED60-48D15W	18 ~ 75	±15	±2	20	91.5	±940
RED60-48D24W	18 ~ 75	±24	±1.25	20	92	±370
RED60-110S3P3W	36 ~ 160	3.3	18.2	10	88	26000
RED60-110S05W	36 ~ 160	5	12	10	91	17000
RED60-110S5P1W	36 ~ 160	5.1	12	10	91	17000
RED60-110S12W	36 ~ 160	12	5	10	92	3000
RED60-110S15W	36 ~ 160	15	4	10	92	1900
RED60-110S24W	36 ~ 160	24	2.5	10	90.5	730
RED60-110S48W	36 ~ 160	48	1.25	20	91	190
RED60-110S53W	36 ~ 160	53	1.14	20	91	150
RED60-110D12W	36 ~ 160	±12	±2.5	20	90.5	±1500
RED60-110D15W	36 ~ 160	±15	±2	20	90.5	±940
RED60-110D24W	36 ~ 160	±24	±1.25	20	91	±370

INPUT SPECIFICATIONS						
Parameter	Conditions		Min.	Typ.	Max.	Unit
Operating input voltage range	24Vin(nom)		9	24	36	VDC
	48Vin(nom)		18	48	75	
	110Vin(nom)		36	110	160	
Start up voltage	24Vin(nom)				9	VDC
	48Vin(nom)				18	
	110Vin(nom)				36	
Shutdown voltage	24Vin(nom)		7	8	8.8	VDC
	48Vin(nom)		15	16	17.5	
	110Vin(nom)		32	34	35.8	
Start up time	Constant resistive load	Power up Remote ON/OFF		30	60	ms
Input surge voltage	1 second, max.	24Vin(nom)			50	VDC
		48Vin(nom)			100	
		110Vin(nom)			200	
Input filter			Pi type			
Remote ON/OFF	Referred to -Vin pin	Positive logic DC-DC ON (Standard) DC-DC OFF	Open or 3 ~ 12VDC Short or 0 ~ 1.2VDC			
		Negative logic DC-DC ON (Option) DC-DC OFF	Short or 0 ~ 1.2VDC Open or 3 ~ 12VDC			
		Input current of Ctrl pin	-0.5		0.5	mA
		Remote off input current		3		mA

OUTPUT SPECIFICATIONS						
Parameter	Conditions		Min.	Typ.	Max.	Unit
Voltage accuracy			-1.0		+1.0	%
Line regulation	Low Line to High Line at Full Load		-0.2		+0.2	%
Load regulation	No Load to Full Load	Single	-0.5		+0.5	%
		Dual	-1.0		+1.0	
Cross regulation	Asymmetrical load 25%/100% FL		-5.0		+5.0	%
Voltage adjustability	Single output	Others	-10		+10	%
		15Vout, 24Vout	-10		+20	
Ripple and noise	Measured by 20MHz bandwidth With a 1 μ F/100V X7R MLCC	3.3Vout, 5Vout, 5.1Vout		75	100	mVp-p
		12Vout, 15Vout		100	125	
		24Vout		150	200	
		48Vout, 53Vout		300	350	
Temperature coefficient			-0.02		+0.02	%/°C
Transient response recovery time	25% load step change			250		μ s
Over voltage protection	Zener diode clamp	3.3Vout		3.9		VDC
		5Vout, 5.1Vout		6.2		
		12Vout		15		
		15Vout		20		
		24Vout		30		
		48Vout 53Vout		60 63		
Over load protection	% of lout rated; Hiccup mode			150		%
Short circuit protection			Continuous, automatics recovery			

GENERAL SPECIFICATIONS

Parameter	Conditions		Min.	Typ.	Max.	Unit
Isolation voltage	1 minute	Input to Output Input (Output) to Case	3000 2250			VDC
Isolation resistance	500VDC		1			GΩ
Isolation capacitance					1500	pF
Switching frequency			200	250	275	kHz
Safety approvals	IEC /UL/ EN62368-1					UL:E193009 CB:UL(Demko)
Standard approvals	EN50155 EN45545-2					
Case material						Copper
Base material						FR4 PCB
Potting material						Silicone (UL94 V-0)
Weight						34g (1.2oz)
MTBF	MIL-HDBK-217F, Full load					7.245 x 10 ⁵ hrs

ENVIRONMENTAL SPECIFICATIONS

Parameter	Conditions		Min.	Typ.	Max.	Unit
Operating ambient temperature		With derating	-40		+105	°C
Maximum case temperature					105	°C
Over temperature protection				115		°C
Storage temperature range			-55		+125	°C
Thermal impedance	Natural convection	Without Heat-sink		10.8		
		With Heat-sink		8.3		
		HC1		7.0		°C/W
		HC2		5.7		
		HC3		5.9		
		HS				
Thermal shock						MIL-STD-810F
Shock						EN61373, MIL-STD-810F
Vibration						EN61373, MIL-STD-810F
Relative humidity						5% to 95% RH

EMC SPECIFICATIONS

Parameter	Conditions	Level
EMI	EN55032, EN50121-3-2 With external components	Class A, Class B
EMS	EN55035, EN50121-3-2	
ESD	EN61000-4-2 Air ± 8kV and Contact ± 6kV	Perf. Criteria A
Radiated immunity	EN61000-4-3 20V/m	Perf. Criteria A
Fast transient	EN61000-4-4 ± 2kV	Perf. Criteria A
	RED60-24□□□W With 2 pcs of aluminum electrolytic capacitor (Nippon chemi-con KY series, 220μF/100V) and a TVS (SMDJ58A, 58V, 3000Watt peak pulse power) in parallel.	
	RED60-48□□□W With 2 pcs of aluminum electrolytic capacitor (Nippon chemi-con KY series, 220μF/100V) and a TVS (SMDJ120A, 120V, 3000Watt peak pulse power) in parallel.	
	RED60-110□□□W With 2 pcs of aluminum electrolytic capacitor (Nippon chemi-con KXJ series, 150μF/200V) and a TVS(SMDJ170A, 170V, 3000Watt peak pulse power) in parallel.	

EMC SPECIFICATIONS(CONTINUED)

Parameter	Conditions		Level
Surge	EN61000-4-5	± 2kV	Perf. Criteria A
	RED60-24□□□W	With 2 pcs of aluminum electrolytic capacitor (Nippon chemi-con KY series, 220μF/100V) and a TVS (SMDJ58A, 58V, 3000Watt peak pulse power) in parallel.	
	RED60-48□□□W	With 2 pcs of aluminum electrolytic capacitor (Nippon chemi-con KY series, 220μF/100V) and a TVS (SMDJ120A, 120V, 3000Watt peak pulse power) in parallel.	
	RED60-110□□□W	With 2 pcs of aluminum electrolytic capacitor (Nippon chemi-con KXJ series, 150μF/200V) and a TVS(SMDJ170A, 170V, 3000Watt peak pulse power) in parallel.	
Conducted immunity	EN61000-4-6	10Vr.m.s	Perf. Criteria A
Power frequency magnetic field	EN61000-4-8	100A/m continuous; 1000A/m 1 second	Perf. Criteria A

Note:

- Input source impedance: The power module will operate as specifications without external components, assuming that the source voltage has a very low impedance and reasonable input voltage regulation. Highly inductive source impedances can affect the stability of the power module. Since real-world voltage source has finite impedance, performance can be improved by adding external filter capacitor. The RED60-110S□□W recommended Ruby-con BXF series, 47μF/200V.

CAUTION: This power module is not internally fused. An input line fuse must always be used.

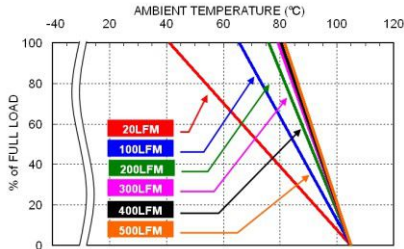
CHARACTERISTIC CURVE

RED60-24S05W Derating Curve

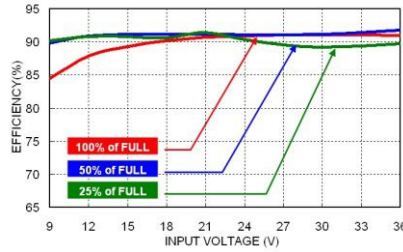

RED60-24S05W Efficiency vs. Input Voltage

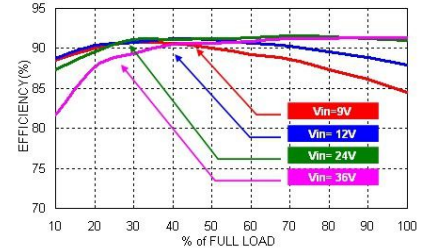

RED60-24S05W Efficiency vs. Output Load

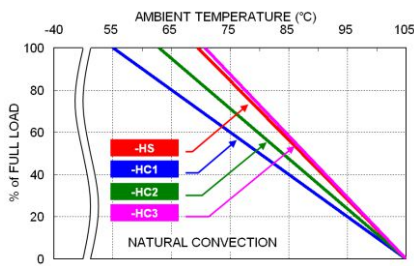
 RED60-24S05W Derating Curve
 With Heat-sink

FUSE CONSIDERATION

This power module is not internally fused. An input line fuse must always be used.

This encapsulated power module can be used in a wide variety of applications, ranging from simple stand-alone operation to an integrated part of sophisticated power architecture.

To maximum flexibility, internal fusing is not included; however, to achieve maximum safety and system protection, always use an input line fuse.

The input line fuse suggest as below :

Model	Fuse Rating (A)	Fuse Type
RED60-24□□□W	10	Fast-Acting
RED60-48□□□W	6.3	Slow-Blow
RED60-110□□□W	3.15	Slow-Blow

The table based on the information provided in this data sheet on inrush energy and maximum DC input current at low Vin.

MECHANICAL DRAWING

Standard 、-HC1 、-HC2 、-HC3

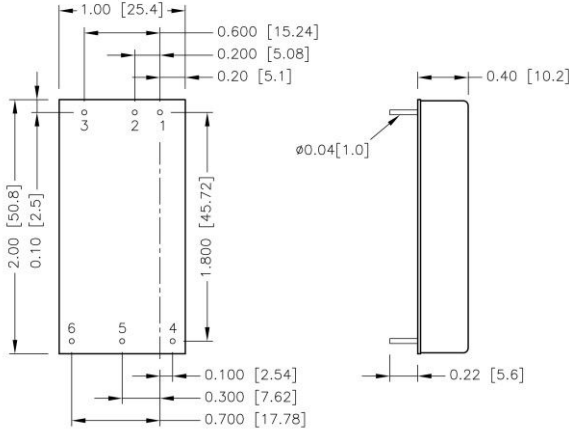

BOTTOM VIEW

-HS

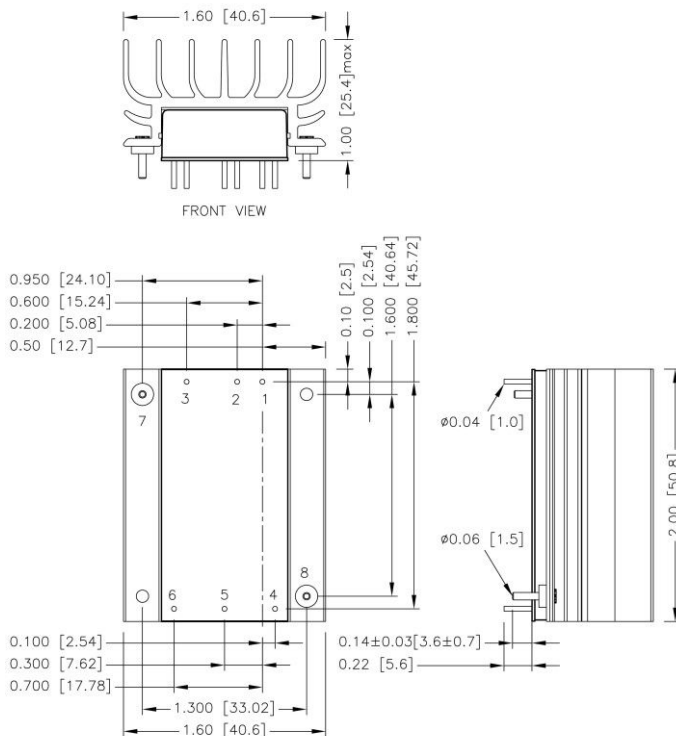

BOTTOM VIEW

PIN CONNECTION

PIN	SINGLE	DUAL
1	+ Vin	+ Vin
2	- Vin	- Vin
3	Ctrl	Ctrl
4	+ Vout	+ Vout
5	- Vout	Com
6	Trim	- Vout

- All dimensions in inch [mm]
Tolerance :x.xx±0.02 [x.x±0.5]
x.xxx±0.010 [x.xx±0.25]
- Pin dimension tolerance ±0.004[0.10]

PIN CONNECTION

PIN	SINGLE	DUAL
1	+ Vin	+ Vin
2	- Vin	- Vin
3	Ctrl	Ctrl
4	+ Vout	+ Vout
5	- Vout	Com
6	Trim	- Vout
7	Heat-sink	Heat-sink
8	Heat-sink	Heat-sink

- All dimensions in inch [mm]
Tolerance :x.xx±0.02 [x.x±0.5]
x.xxx±0.010 [x.xx±0.25]
- Pin dimension tolerance ±0.004[0.10]

RECOMMENDED PAD LAYOUT

Standard

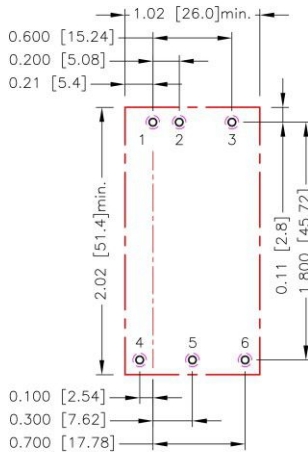

All dimensions in inch[mm]
 Pad size(lead free recommended)
 Through hole 1.2.3.4.5.6: $\Phi 0.051[1.30]$
 Top view pad 1.2.3.4.5.6: $\Phi 0.064[1.63]$
 Bottom view pad 1.2.3.4.5.6: $\Phi 0.102[2.60]$

-HS

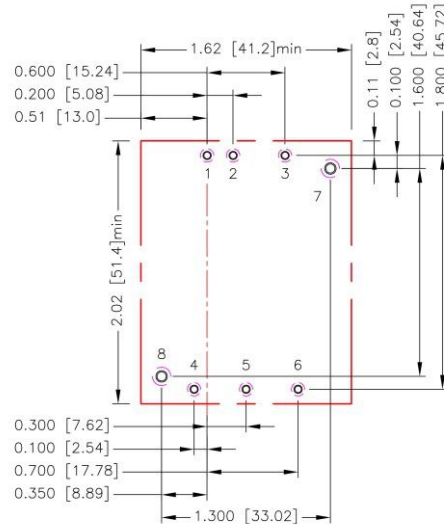

All dimensions in inch[mm]
 Pad size(lead free recommended)
 Through hole 1.2.3.4.5.6: $\Phi 0.051[1.30]$
 Through hole 7.8: $\Phi 0.071[1.80]$
 Top view pad 1.2.3.4.5.6: $\Phi 0.064[1.63]$
 Top view pad 7.8: $\Phi 0.089[2.25]$
 Bottom view pad 1.2.3.4.5.6: $\Phi 0.102[2.60]$
 Bottom view pad 7.8: $\Phi 0.142[3.60]$

-HC1、-HC2、-HC3

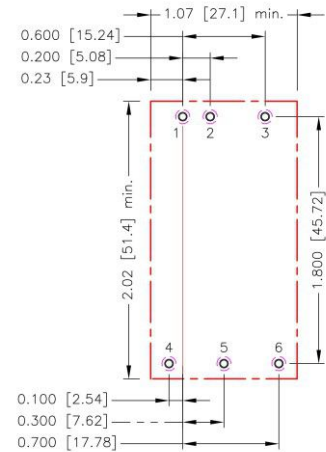

All dimensions in inch[mm]
 Pad size(lead free recommended)
 Through hole 1.2.3.4.5.6: $\Phi 0.051[1.30]$
 Top view pad 1.2.3.4.5.6: $\Phi 0.064[1.63]$
 Bottom view pad 1.2.3.4.5.6: $\Phi 0.102[2.60]$

THERMAL CONSIDERATIONS

The power module operates in a variety of thermal environments. However, sufficient cooling should be provided to help ensure reliable operation of the unit. Heat is removed by conduction, convection, and radiation to the surrounding environment. Proper cooling can be verified by measuring the point as the figure below. The temperature at this location should not exceed "Maximum case temperature". When operating, adequate cooling must be provided to maintain the test point temperature at or below "Maximum case temperature". You can limit this temperature to a lower value for extremely high reliability.

- Thermal test condition with vertical direction by natural convection (20LFM).

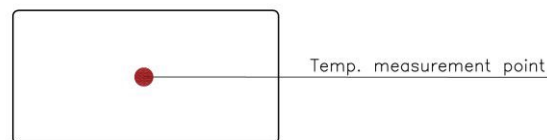

TOP VIEW

HEAT-SINK TYPE OPTIONS

RED60-□□□□□W-**HS**
7G-0110A-F

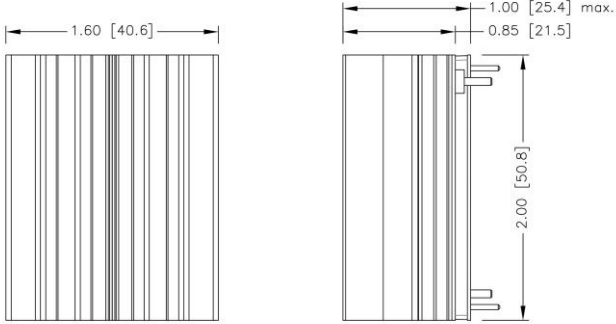

SIDE VIEW

RED60-□□□□□W-**HC1**
7GA0120P01-F

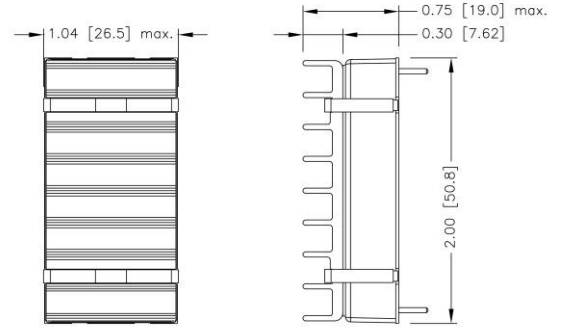

SIDE VIEW

RED60-□□□□□W-**HC2**
7GA0121P01-F

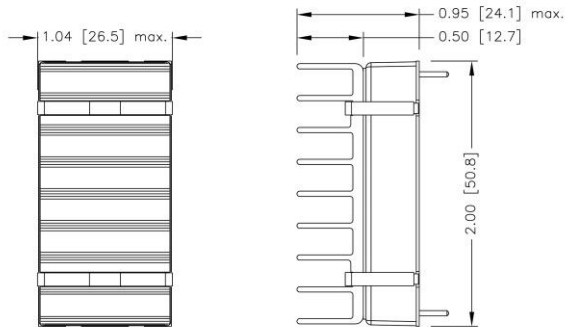

SIDE VIEW

RED60-□□□□□W-**HC3**
7GA0122P01-F

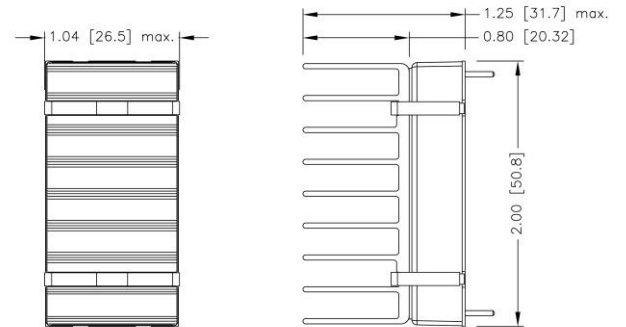

SIDE VIEW

1. All dimensions in inch [mm]
2. Tolerance :x.xx±0.02 [x.x±0.5]
x.xxx±0.010 [x.xx±0.25]

OUTPUT VOLTAGE ADJUSTMENT

It allows the user to increase or decrease the output voltage of the module.

This is accomplished by connecting an external resistor between the Trim pin and either the +Vout or -Vout pins.

With an external resistor between the Trim and -Vout pin, the output voltage increases.

With an external resistor between the Trim and +Vout pin, the output voltage decreases.

The external Trim resistor needs to be at least 1/8W of rated power.

EXTERNAL OUTPUT TRIMMING

Output can be externally trimmed by using the method shown below.

Trim-up

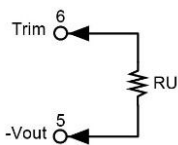

□□S3P3W

ΔV (%)	1	2	3	4	5	6	7	8	9	10
Vout (V)	3.333	3.366	3.399	3.432	3.465	3.498	3.531	3.564	3.597	3.630
RU (k Ω)	43.179	21.758	13.410	8.966	6.206	4.325	2.961	1.927	1.115	0.462

□□S05W

ΔV (%)	1	2	3	4	5	6	7	8	9	10
Vout (V)	5.05	5.10	5.15	5.20	5.25	5.30	5.35	5.40	5.45	5.50
RU (k Ω)	35.360	16.244	9.752	6.483	4.514	3.198	2.257	1.550	1.000	0.559

□□S5P1W

ΔV (%)	1	2	3	4	5	6	7	8	9	10
Vout (V)	5.151	5.202	5.253	5.304	5.355	5.406	5.457	5.508	5.559	5.610
RU (k Ω)	36.753	16.700	10.001	6.649	4.637	3.295	2.337	1.618	1.059	0.611

□□S12W

ΔV (%)	1	2	3	4	5	6	7	8	9	10
Vout (V)	12.12	12.24	12.36	12.48	12.60	12.72	12.84	12.96	13.08	13.20
RU (k Ω)	392.864	172.175	101.446	66.591	45.837	32.068	22.264	14.929	9.234	4.685

□□S15W

ΔV (%)	1	2	3	4	5	6	7	8	9	10
Vout (V)	15.15	15.30	15.45	15.60	15.75	15.90	16.05	16.20	16.35	16.50
RU (k Ω)	413.163	198.115	125.754	89.445	67.618	53.050	42.636	34.820	28.739	23.872

ΔV (%)	11	12	13	14	15	16	17	18	19	20
Vout (V)	16.65	16.80	16.95	17.10	17.25	17.40	17.55	17.70	17.85	18.00
RU (k Ω)	19.888	16.568	13.759	11.350	9.262	7.434	5.822	4.389	3.106	1.951

□□S24W

ΔV (%)	1	2	3	4	5	6	7	8	9	10
Vout (V)	24.24	24.48	24.72	24.96	25.20	25.44	25.68	25.92	26.16	26.40
RU (k Ω)	947.146	472.772	303.499	216.605	163.724	128.153	102.589	83.329	68.298	56.240

ΔV (%)	11	12	13	14	15	16	17	18	19	20
Vout (V)	26.64	26.88	27.12	27.36	27.60	27.84	28.08	28.32	28.56	28.80
RU (k Ω)	46.353	38.099	31.104	25.101	19.892	15.330	11.302	7.718	4.509	1.619

□□S48W

ΔV (%)	1	2	3	4	5	6	7	8	9	10
Vout (V)	48.48	48.96	49.44	49.92	50.40	50.88	51.36	51.84	52.32	52.80
RU (k Ω)	531.639	226.403	131.987	86.042	58.867	40.910	28.162	18.642	11.263	5.376

□□S53W

ΔV (%)	1	2	3	4	5	6	7	8	9	10
Vout (V)	53.53	54.06	54.59	55.12	55.65	56.18	56.71	57.24	57.77	58.30
RU (k Ω)	626.943	246.365	140.489	90.768	61.891	43.022	29.726	19.853	12.231	6.169

OUTPUT VOLTAGE ADJUSTMENT(CONTINUED)

Trim-down

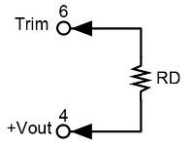
□□S3P3W

ΔV (%)	1	2	3	4	5	6	7	8	9	10
Vout (V)	3.267	3.234	3.201	3.168	3.135	3.102	3.069	3.036	3.003	2.970
RD (k Ω)	68.728	31.256	18.592	12.227	8.398	5.841	4.012	2.639	1.570	0.715

□□S05W

ΔV (%)	1	2	3	4	5	6	7	8	9	10
Vout (V)	4.95	4.90	4.85	4.80	4.75	4.70	4.65	4.60	4.55	4.50
RD (k Ω)	46.686	20.817	12.360	8.162	5.653	3.984	2.794	1.903	1.210	0.656

□□S5P1W

ΔV (%)	1	2	3	4	5	6	7	8	9	10
Vout (V)	5.049	4.998	4.947	4.8960	4.845	4.794	4.743	4.692	4.641	4.590
RD (k Ω)	47.801	21.688	13.003	8.663	6.061	4.326	3.088	2.159	1.436	0.859

□□S12W

ΔV (%)	1	2	3	4	5	6	7	8	9	10
Vout (V)	11.88	11.76	11.64	11.52	11.40	11.28	11.16	11.04	10.92	10.80
RD (k Ω)	435.294	201.116	120.429	79.573	54.894	38.371	26.535	17.639	10.709	5.157

□□S15W

ΔV (%)	1	2	3	4	5	6	7	8	9	10
Vout (V)	14.85	14.70	14.55	14.40	14.25	14.10	13.95	13.80	13.65	13.50
RD (k Ω)	302.154	132.978	78.547	51.685	35.680	25.055	17.489	11.826	7.429	3.916

□□S24W

ΔV (%)	1	2	3	4	5	6	7	8	9	10
Vout (V)	23.76	23.52	23.28	23.04	22.80	22.56	22.32	22.08	21.84	21.60
RD (k Ω)	736.063	326.672	192.473	125.790	85.913	59.383	40.459	26.282	15.263	6.454

□□S48W

ΔV (%)	1	2	3	4	5	6	7	8	9	10
Vout (V)	47.52	47.04	46.56	46.08	45.60	45.12	44.64	44.16	43.68	43.20
RD (k Ω)	558.604	257.390	153.744	101.292	69.616	48.413	33.225	21.811	12.920	5.798

□□S53W

ΔV (%)	1	2	3	4	5	6	7	8	9	10
Vout (V)	52.47	51.94	51.41	50.88	50.35	49.82	49.29	48.76	48.23	47.70
RD (k Ω)	551.986	256.323	153.564	101.358	69.765	48.589	33.408	21.991	13.093	5.962