

Serial EEPROM Series Standard EEPROM Microwire BUS EEPROM(3-Wire) BR93Lxx-W

●General Description

BR93Lxx-W is serial EEPROM of serial 3-line interface method

●Features

- 3-line communications of chip select, serial clock, serial data input / output (the case where input and output are shared)
- Actions available at high speed 2MHz clock(2.5V to 5.5V)
- Speed write available (write time 5ms max.)
- Same package and pin layout from 1Kbit to 16Kbit
- 1.8V to 5.5V single power source action
- Address auto increment function at read action
- Write mistake prevention function
 - Write prohibition at power on
 - Write prohibition by command code
 - Write mistake prevention function at low voltage
- Program cycle auto delete and auto end function
- Program condition display by READY / BUSY
- Low current consumption
 - At write action (at 5V) : 1.2mA (Typ.)
 - At read action (at 5V) : 0.3mA (Typ.)
 - At standby action (at 5V) : 0.1μA (Typ.)(CMOS input)
- TTL compatible(input / outputs)
- Data retention for 40 years
- Endurance up to 1,000,000 times
- Data at shipment all addresses FFFFh

●Packages W(Typ.) x D(Typ.) x H(Max.)

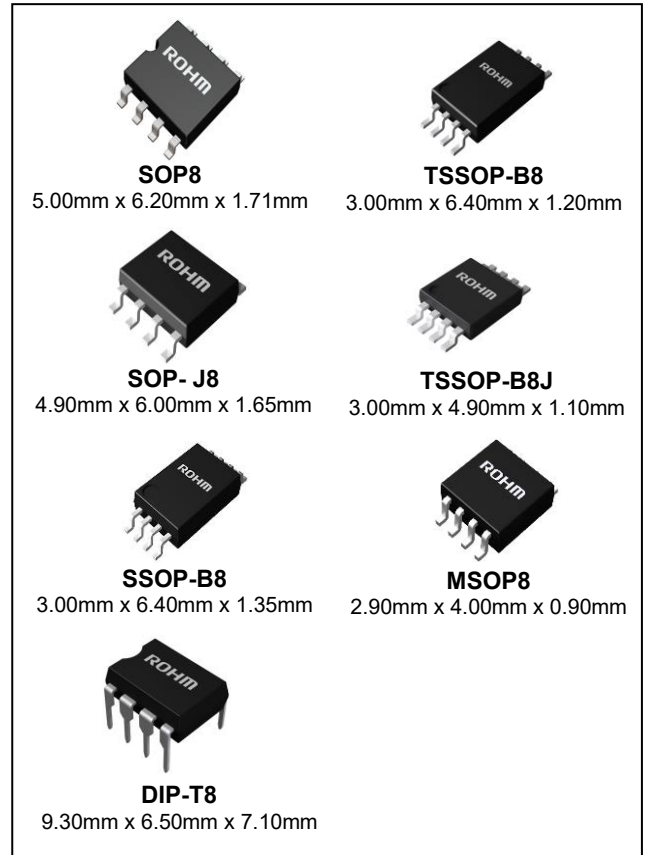

Figure.1

●BR93Lxx-W

Active Products

| Package type | | | | SOP8 | | SOP-J8 | | SSOP-B8 | | TSSOP-B8 | | MSOP8 | TSSOP-B8J | DIP-T8 |
|--------------|------------|-----------|----------------------|------|----|--------|-----|---------|-----|----------|------|-------|-----------|--------|
| Capacity | Bit format | Type | Power source voltage | F | RF | FJ | RFJ | FV | RFV | FVT | RFVT | RFVM | RFVJ | - |
| 1Kbit | 64 × 16 | BR93L46-W | 1.8V to 5.5V | ● | ● | ● | ● | ● | ● | ● | ● | ● | ● | ● |
| 2Kbit | 128 × 16 | BR93L56-W | 1.8V to 5.5V | ● | ● | ● | ● | ● | ● | ● | ● | ● | ● | ● |
| 4Kbit | 256 × 16 | BR93L66-W | 1.8V to 5.5V | ● | ● | ● | ● | ● | ● | ● | ● | ● | ● | ● |
| 8Kbit | 512 × 16 | BR93L76-W | 1.8V to 5.5V | ● | ● | | ● | | ● | | ● | ● | ● | ● |
| 16Kbit | 1K × 16 | BR93L86-W | 1.8V to 5.5V | ● | ● | ● | ● | | ● | | ● | ● | ● | ● |

Last Time Buy Products

| Package type | | | | SOP8 | | SOP-J8 | | SSOP-B8 | | TSSOP-B8 | | MSOP8 | TSSOP-B8J | DIP-T8 |
|--------------|------------|-----------|----------------------|------|----|--------|-----|---------|-----|----------|------|-------|-----------|--------|
| Capacity | Bit format | Type | Power source voltage | F | RF | FJ | RFJ | FV | RFV | FVT | RFVT | RFVM | RFVJ | - |
| 8Kbit | 512 × 16 | BR93L76-W | 1.8V to 5.5V | | | ● | | | | | | | | |

○Product structure : Silicon monolithic integrated circuit ○This product is not designed protection against radioactive rays

● Absolute Maximum Ratings (Ta=25°C)

| Parameter | Symbol | Limits | Unit | Remarks |
|---------------------------|--------|-----------------|------|--|
| Impressed voltage | Vcc | -0.3 to +6.5 | V | |
| Permissible dissipation | Pd | 450 (SOP8) | mW | When using at Ta=25°C or higher, 4.5mW, to be reduced per 1°C. |
| | | 450 (SOP-J8) | | When using at Ta=25°C or higher, 4.5mW, to be reduced per 1°C. |
| | | 300 (SSOP-B8) | | When using at Ta=25°C or higher, 3.0mW, to be reduced per 1°C. |
| | | 330 (TSSOP-B8) | | When using at Ta=25°C or higher, 3.3mW, to be reduced per 1°C. |
| | | 310 (MSOP8) | | When using at Ta=25°C or higher, 3.1mW, to be reduced per 1°C. |
| | | 310 (TSSOP-B8J) | | When using at Ta=25°C or higher, 3.1mW, to be reduced per 1°C. |
| | | 800(DIP-T8) | | When using at Ta=25°C or higher, 8.0mW, to be reduced per 1°C. |
| Storage temperature range | Tstg | -65 to +125 | °C | |
| Action temperature range | Topr | -40 to +85 | °C | |
| Terminal voltage | - | -0.3 to Vcc+0.3 | V | |

● Memory Cell Characteristics (Vcc=1.8V to 5.5V)

| Parameter | Limit | | | Unit | Condition |
|-------------------|-----------|------|------|-------|-----------|
| | Min. | Typ. | Max. | | |
| Endurance *1 | 1,000,000 | - | - | Times | Ta=25°C |
| Data retention *1 | 40 | - | - | Years | Ta=25°C |

○ Shipment data all address FFFFh

*1 : Not 100% TESTED

● Recommended Operating Ratings

| Parameter | Symbol | Limits | Unit |
|----------------------|--------|------------|------|
| Power source voltage | Vcc | 1.8 to 5.5 | V |
| Input voltage | VIN | 0 to Vcc | |

●Electrical Characteristics

(Unless otherwise specified, $V_{CC}=2.5V$ to $5.5V$, $T_a=-40^{\circ}C$ to $+85^{\circ}C$)

| Parameter | Symbol | Limits | | | Unit | Condition |
|-------------------------------|-----------|---------------------|------|---------------------|---------|--|
| | | Min. | Typ. | Max. | | |
| "L" input voltage 1 | V_{IL1} | -0.3 | - | 0.8 | V | $4.0V \leq V_{CC} \leq 5.5V$ |
| "L" input voltage 2 | V_{IL2} | -0.3 | - | $0.2 \times V_{CC}$ | V | $V_{CC} \leq 4.0V$ |
| "H" input voltage 1 | V_{IH1} | 2.0 | - | $V_{CC} + 0.3$ | V | $4.0V \leq V_{CC} \leq 5.5V$ |
| "H" input voltage 2 | V_{IH2} | $0.7 \times V_{CC}$ | - | $V_{CC} + 0.3$ | V | $V_{CC} \leq 4.0V$ |
| "L" output voltage 1 | V_{OL1} | 0 | - | 0.4 | V | $I_{OL}=2.1mA$, $4.0V \leq V_{CC} \leq 5.5V$ |
| "L" output voltage 2 | V_{OL2} | 0 | - | 0.2 | V | $I_{OL}=100\mu A$ |
| "H" output voltage 1 | V_{OH1} | 2.4 | - | V_{CC} | V | $I_{OH}=-0.4mA$, $4.0V \leq V_{CC} \leq 5.5V$ |
| "H" output voltage 2 | V_{OH2} | $V_{CC} - 0.2$ | - | V_{CC} | V | $I_{OH}=-100\mu A$ |
| Input leak current | I_{LI} | -1 | - | 1 | μA | $V_{IN}=0V$ to V_{CC} |
| Output leak current | I_{LO} | -1 | - | 1 | μA | $V_{OUT}=0V$ to V_{CC} , $CS=0V$ |
| Current consumption at action | I_{CC1} | - | - | 3.0 | mA | $f_{SK}=2MHz$, $t_{E/W}=5ms$ (WRITE) |
| | I_{CC2} | - | - | 1.5 | mA | $f_{SK}=2MHz$ (READ) |
| | I_{CC3} | - | - | 4.5 | mA | $f_{SK}=2MHz$, $t_{E/W}=5ms$ (WRAL, ERAL) |
| Standby current | I_{SB} | - | - | 2 | μA | $CS=0V$, $DO=OPEN$ |

(Unless otherwise specified, $V_{CC}=1.8V$ to $2.5V$, $T_a=-40^{\circ}C$ to $+85^{\circ}C$)

| Parameter | Symbol | Limits | | | Unit | Condition |
|-------------------------------|-----------|---------------------|------|---------------------|---------|--|
| | | Min. | Typ. | Max. | | |
| "L" input voltage | V_{IL} | -0.3 | - | $0.2 \times V_{CC}$ | V | |
| "H" input voltage | V_{IH} | $0.7 \times V_{CC}$ | - | $V_{CC}+0.3$ | V | |
| "L" output voltage | V_{OL} | 0 | - | 0.2 | V | $I_{OL}=100\mu A$ |
| "H" output voltage | V_{OH} | $V_{CC}-0.2$ | - | V_{CC} | V | $I_{OH}=-100\mu A$ |
| Input leak current | I_{LI} | -1 | - | 1 | μA | $V_{IN}=0V$ to V_{CC} |
| Output leak current | I_{LO} | -1 | - | 1 | μA | $V_{OUT}=0V$ to V_{CC} , $CS=0V$ |
| Current consumption at action | I_{CC1} | - | - | 1.5 | mA | $f_{SK}=500kHz$, $t_{E/W}=5ms$ (WRITE) |
| | I_{CC2} | - | - | 0.5 | mA | $f_{SK}=500kHz$ (READ) |
| | I_{CC3} | - | - | 2 | mA | $f_{SK}=500kHz$, $t_{E/W}=5ms$ (WRAL, ERAL) |
| Standby current | I_{SB} | - | - | 2 | μA | $CS=0V$, $DO=OPEN$ |

●Action Timing Characteristics

($T_a = -40^\circ\text{C}$ to $+85^\circ\text{C}$, $V_{CC} = 2.5\text{V}$ to 5.5V)

| Parameter | Symbol | $2.5\text{V} \leq V_{CC} \leq 5.5\text{V}$ | | | Unit |
|--------------------------------------|-----------|--|------|------|------|
| | | Min. | Typ. | Max. | |
| SK frequency | f_{SK} | - | - | 2 | MHz |
| SK "H" time | t_{SKH} | 230 | - | - | ns |
| SK "L" time | t_{SKL} | 230 | - | - | ns |
| CS "L" time | t_{CS} | 200 | - | - | ns |
| CS setup time | t_{CSS} | 50 | - | - | ns |
| DI setup time | t_{DIS} | 100 | - | - | ns |
| CS hold time | t_{CSH} | 0 | - | - | ns |
| DI hold time | t_{DIH} | 100 | - | - | ns |
| Data "1" output delay time | t_{PD1} | - | - | 200 | ns |
| Data "0" output delay time | t_{PD0} | - | - | 200 | ns |
| Time from CS to output establishment | t_{SV} | - | - | 150 | ns |
| Time from CS to High-Z | t_{DF} | - | - | 150 | ns |
| Write cycle time | $t_{E/W}$ | - | - | 5 | ms |

($T_a = -40^\circ\text{C}$ to $+85^\circ\text{C}$, $V_{CC} = 1.8\text{V}$ to 2.5V)

| Parameter | Symbol | $1.8\text{V} \leq V_{CC} \leq 2.5\text{V}$ | | | Unit |
|--------------------------------------|-----------|--|------|------|------|
| | | Min. | Typ. | Max. | |
| SK frequency | f_{SK} | - | - | 500 | kHz |
| SK "H" time | t_{SKH} | 0.8 | - | - | us |
| SK "L" time | t_{SKL} | 0.8 | - | - | us |
| CS "L" time | t_{CS} | 1 | - | - | us |
| CS setup time | t_{CSS} | 200 | - | - | ns |
| DI setup time | t_{DIS} | 100 | - | - | ns |
| CS hold time | t_{CSH} | 0 | - | - | ns |
| DI hold time | t_{DIH} | 100 | - | - | ns |
| Data "1" output delay time | t_{PD1} | - | - | 0.7 | us |
| Data "0" output delay time | t_{PD0} | - | - | 0.7 | us |
| Time from CS to output establishment | t_{SV} | - | - | 0.7 | us |
| Time from CS to High-Z | t_{DF} | - | - | 200 | ns |
| Write cycle time | $t_{E/W}$ | - | - | 5 | ms |

●Sync Data Input / Output Timing

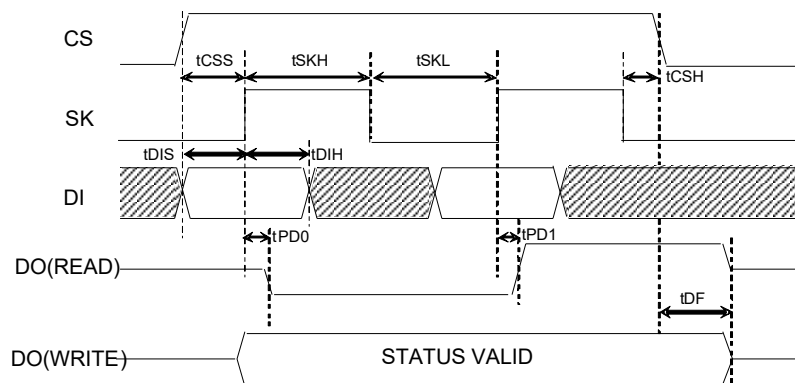

○Data is taken by DI sync with the rise of SK.

○At read action, data is output from DO in sync with the rise of SK.

○The status signal at write (READY / BUSY) is output after t_{CS} from the fall of CS after write command input, at the area DO where CS is "H", and valid until the next command start bit is input. And, while CS is "L", DO becomes High-Z.

○After completion of each mode execution, set CS "L" once for internal circuit reset, and execute the following action mode.

●Block Diagram

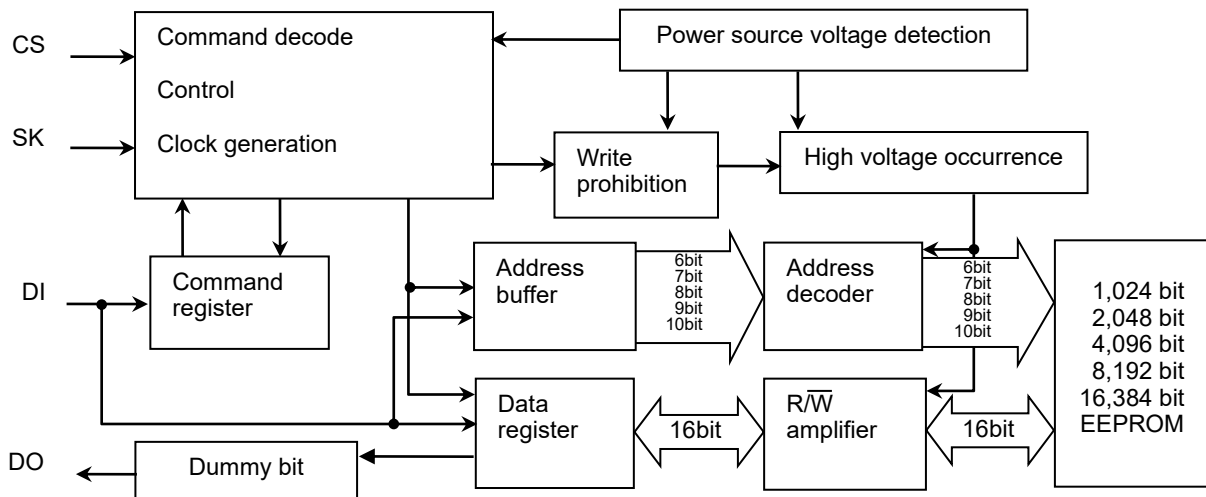

●Pin Configurations

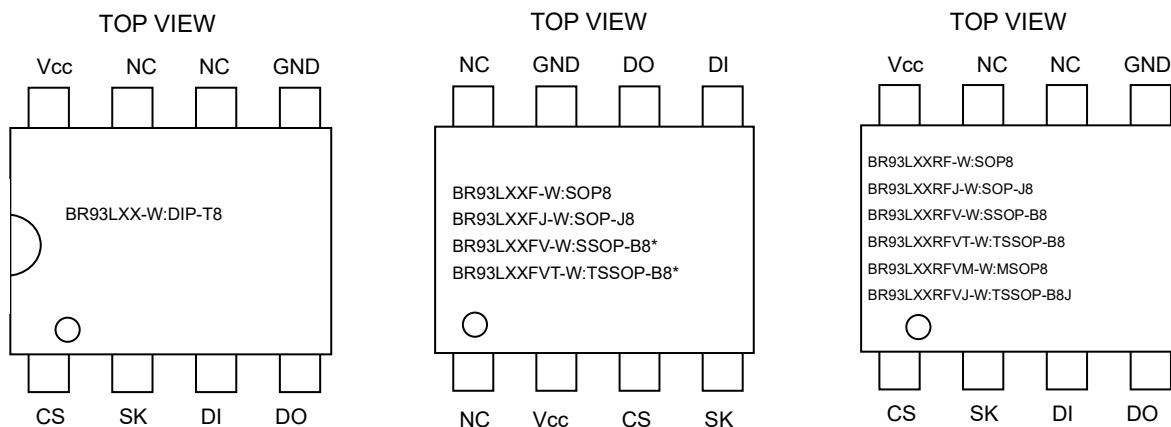

*BR93L46/56/66-W

●Pin Descriptions

| Pin name | I / O | Function |
|----------|--------|--|
| Vcc | - | Power source |
| GND | - | All input / output reference voltage, 0V |
| CS | Input | Chip select input |
| SK | Input | Serial clock input |
| DI | Input | Start bit, ope code, address, and serial data input |
| DO | Output | Serial data output, READY / $\overline{\text{BUSY}}$ internal condition display output |
| NC | - | Non connected terminal, Vcc, GND or OPEN |

● Typical Performance Curves

(The following characteristic data are typ. values.)

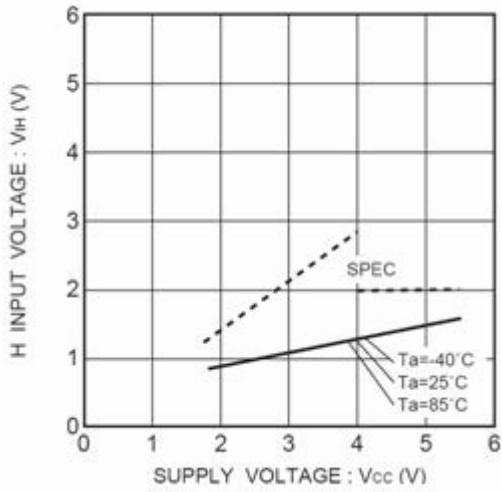

Figure 2. H input voltage V_{IH} (CS,SK,DI)

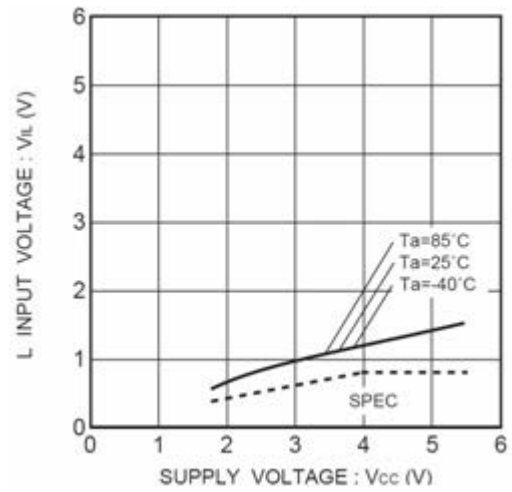

Figure 3. L input voltage V_{IL} (CS,SK,DI)

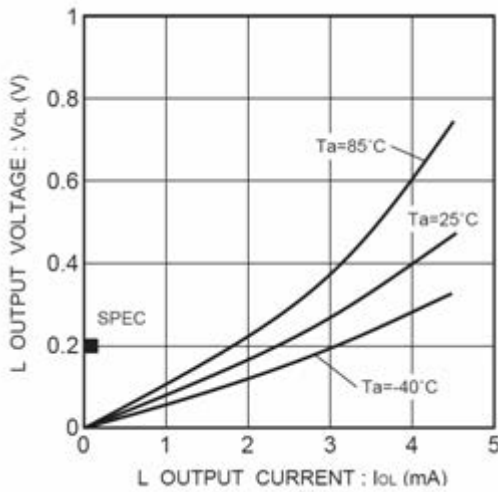

Figure 4. L output voltage V_{OL} - I_{OL} ($V_{CC}=1.8\text{V}$)

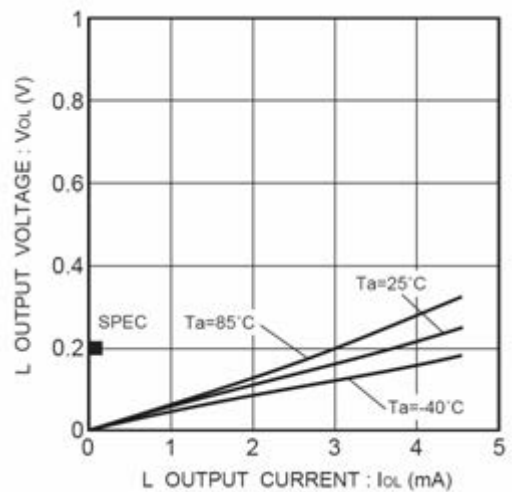

Figure 5. L output voltage V_{OL} - I_{OL} ($V_{CC}=2.5\text{V}$)

● Typical Performance Curves - Continued

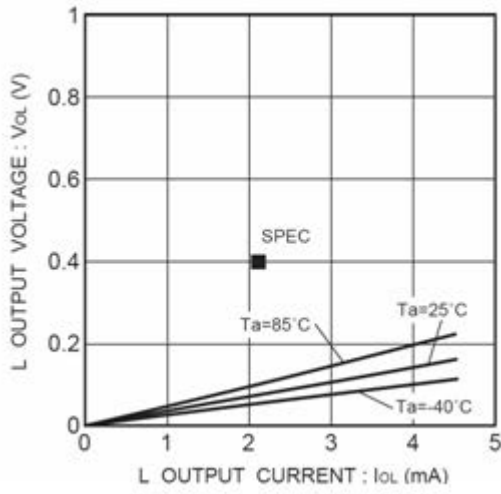

Figure 6. L output voltage VOL-IOL (Vcc=4.0V)

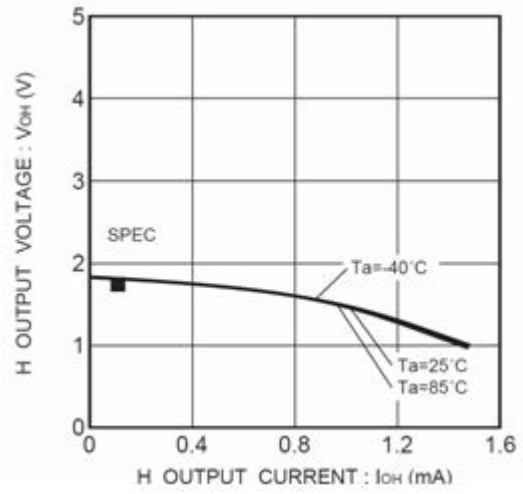

Figure 7. H output voltage VOH-IOH (Vcc=1.8V)

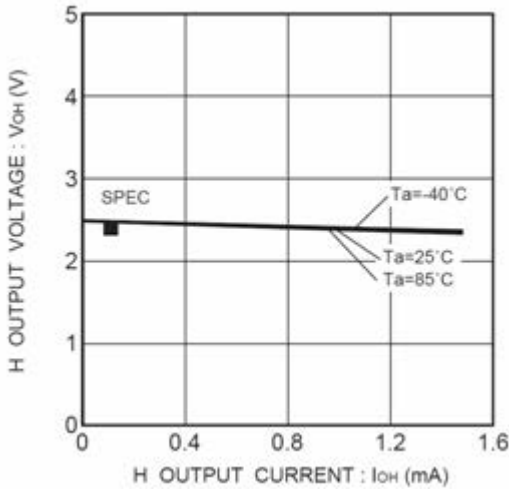

Figure 8. H output voltage VOH-IOH (Vcc=2.5V)

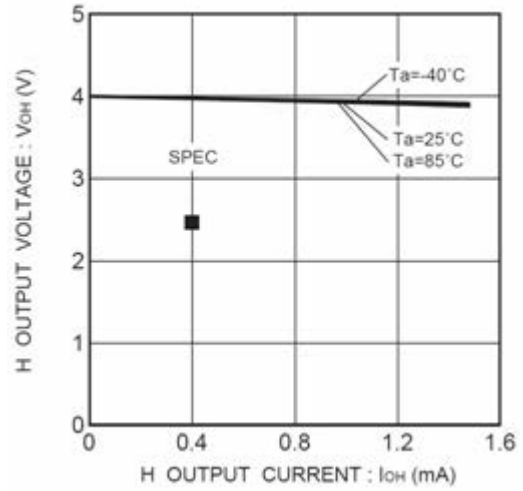

Figure 9. H output voltage VOH-IOH (Vcc=4.0V)

● Typical Performance Curves - Continued

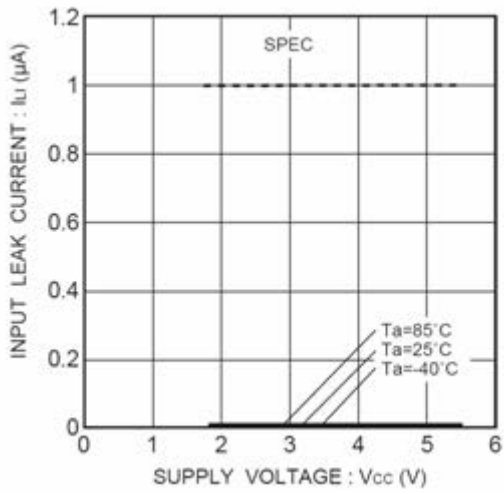

Figure 10. Input leak current I_{LI} (CS,SK,DI)

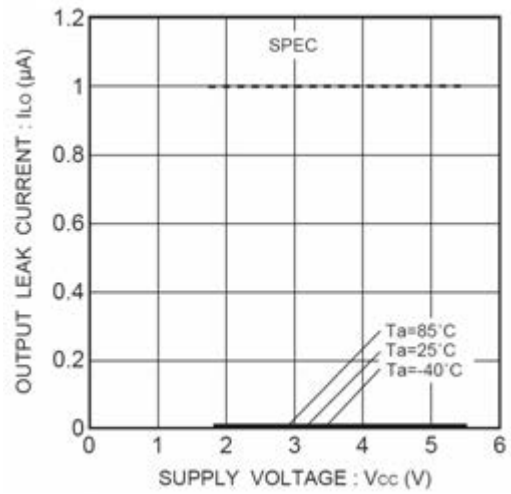

Figure 11. Output leak current I_{LO} (DO)

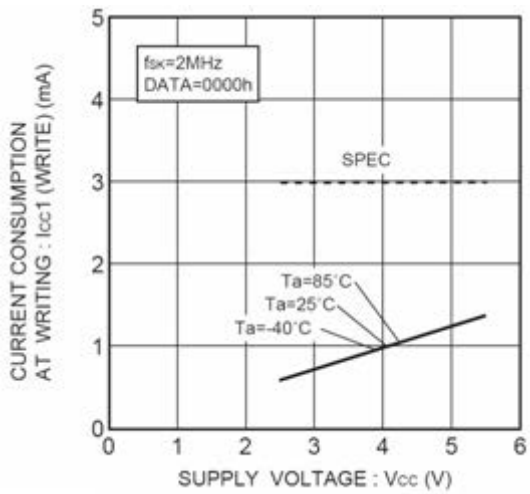

Figure 12. Current consumption at WRITE action ICC₁ (WRITE, fSK=2MHz)

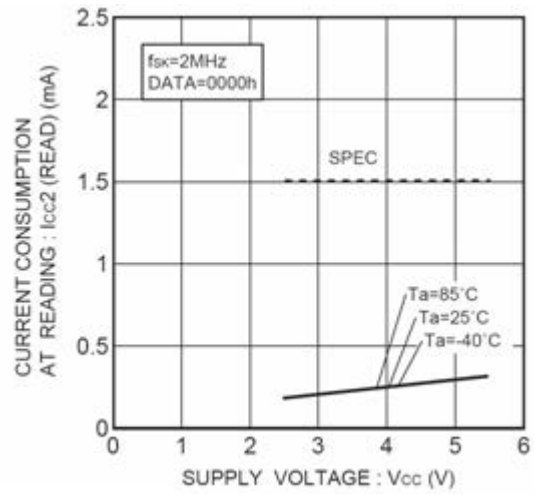

Figure 13. Consumption current at READ action ICC₂ (READ, fSK=2MHz)

● Typical Performance Curves - Continued

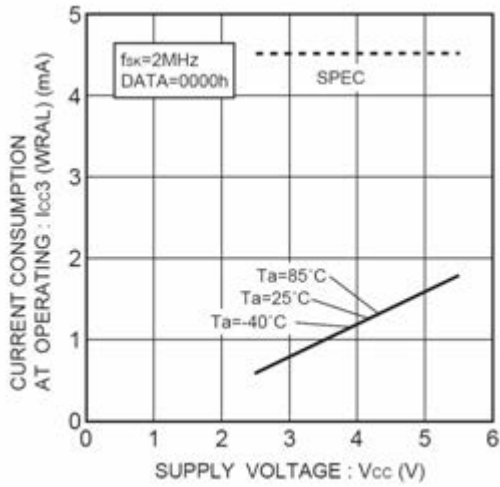

Figure 14. Consumption current at WRAL action ICC3 (WRAL, fSK=2MHz)

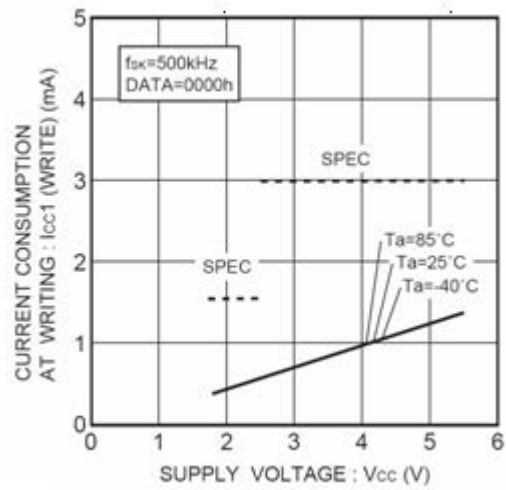

Figure 15. Current consumption at WRITE action ICC1 (WRITE, fSK=500kHz)

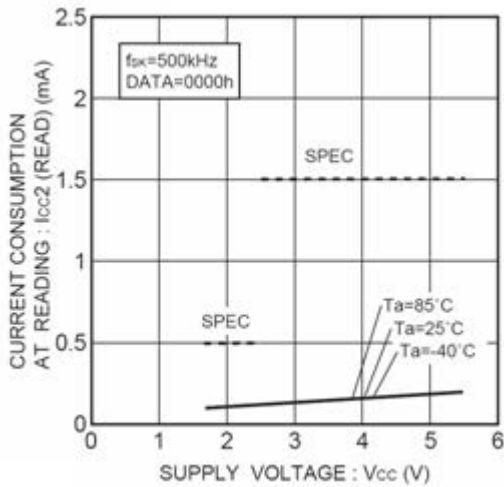

Figure 16. Consumption current at READ action ICC2 (READ, fSK=500kHz)

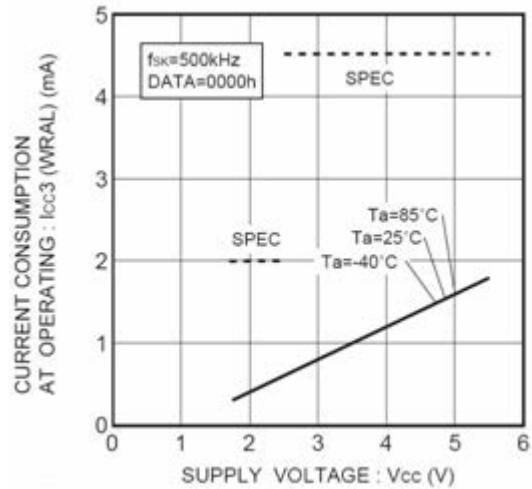

Figure 17. Consumption current at WRAL action ICC3 (WRAL, fSK=500kHz)

● Typical Performance Curves - Continued

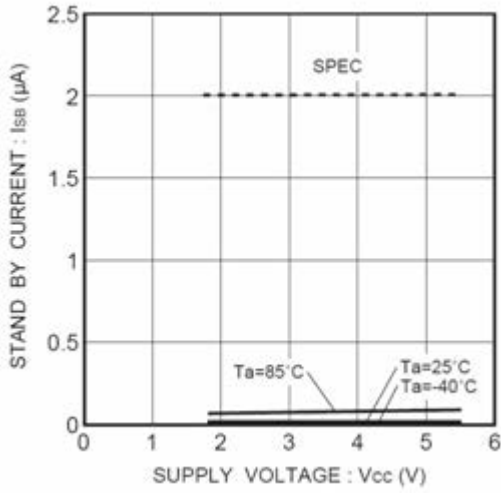

Figure 18. Consumption current at standby action I_{SB}

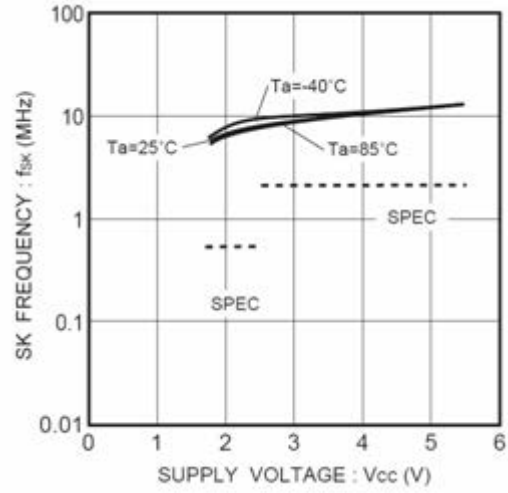

Figure 19. SK frequency f_{SK}

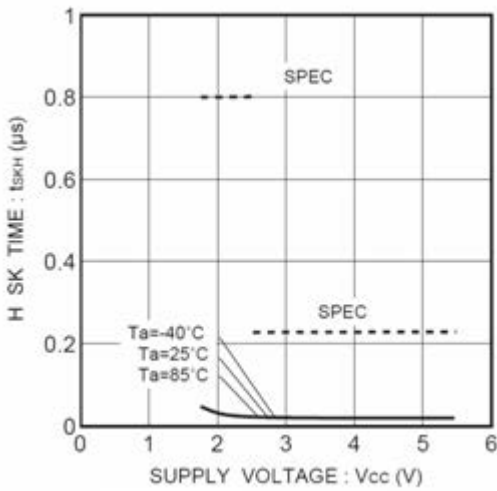

Figure 20. SK high time t_{SKH}

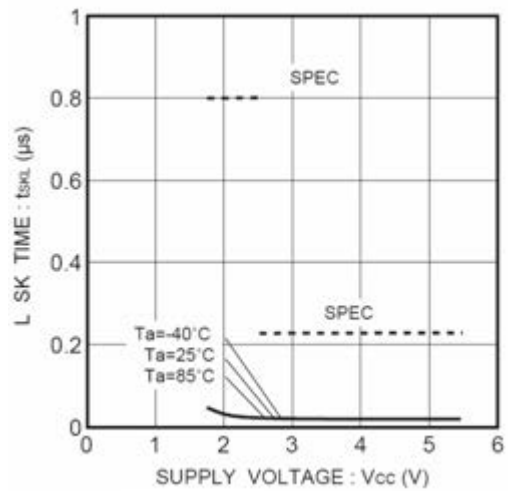

Figure 21. SK low time t_{SKL}

● Typical Performance Curves - Continued

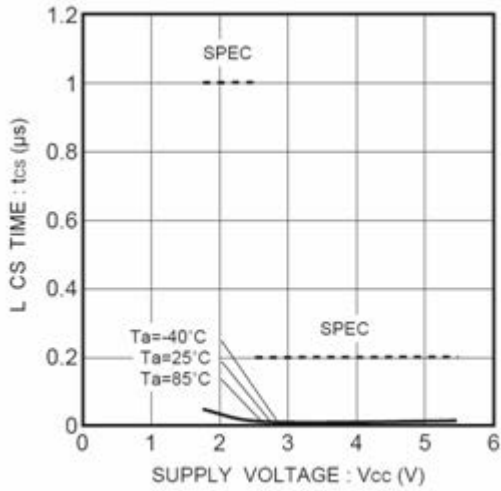

Figure 22. CS low time tCS

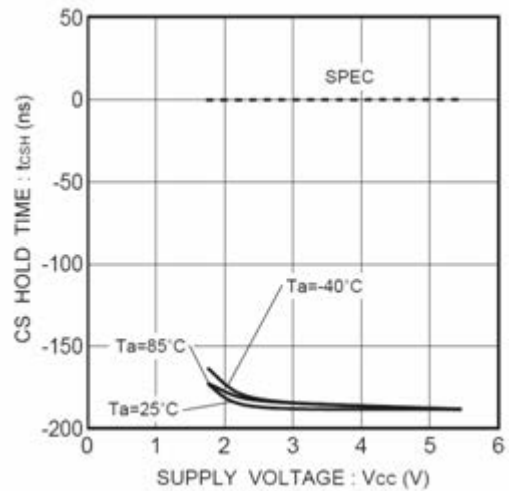

Figure 23. CS hold time tCSH

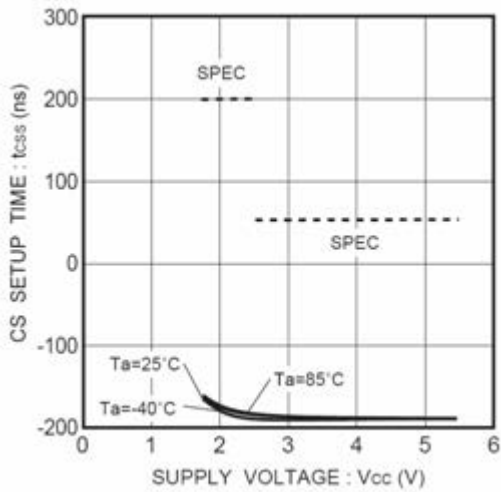

Figure 24. CS setup time tCSS

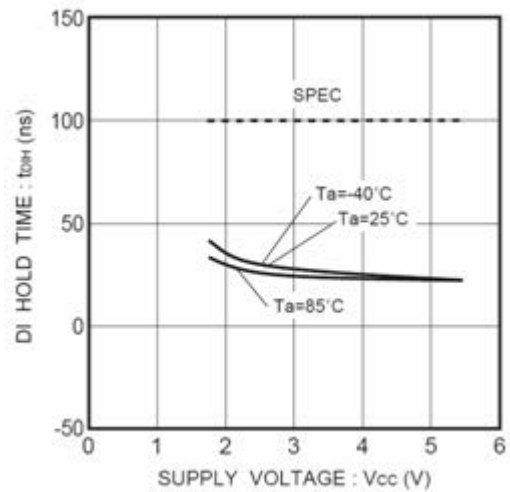

Figure 25. DI hold time tDIH

● Typical Performance Curves - Continued

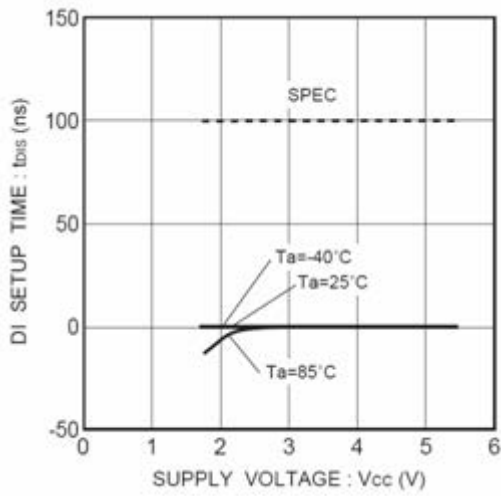

Figure 26. DI setup time tDIS

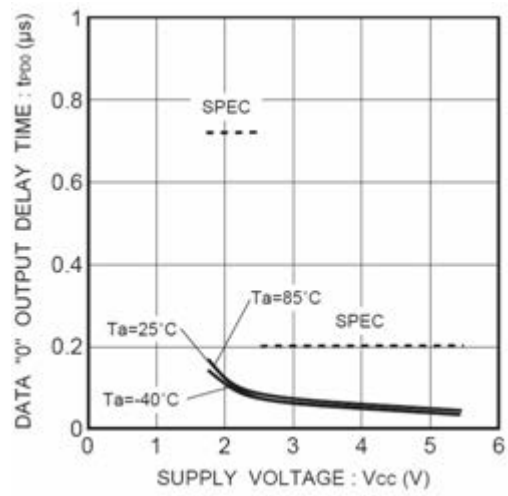

Figure 27. Data "0" output delay time tPD0

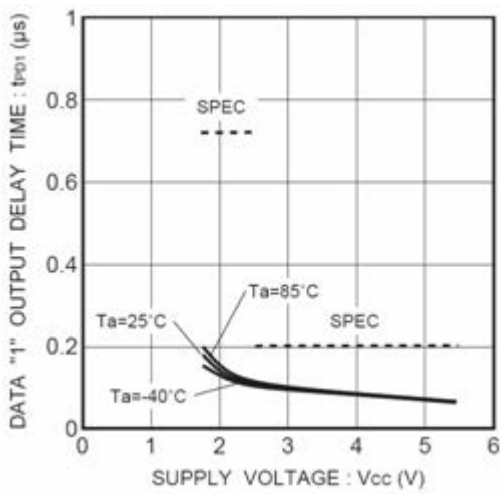

Figure 28. Output data "1" delay time tPD1

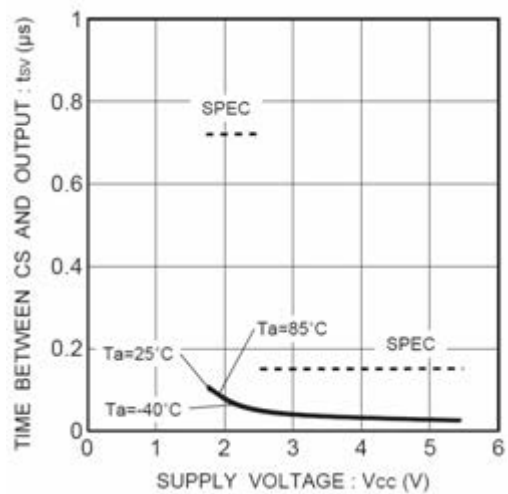

Figure 29. Time from CS to output establishment tSV

● Typical Performance Curves - Continued

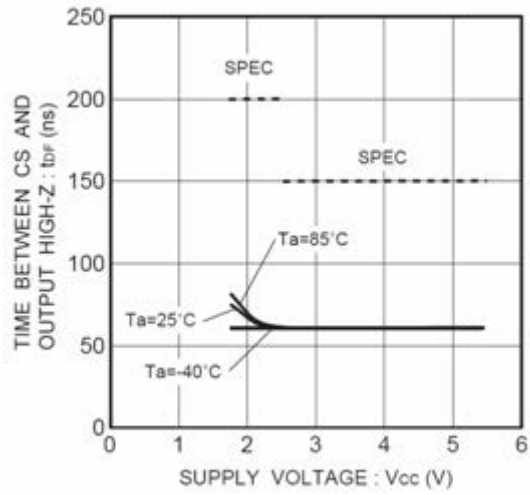

Figure 30. Time from CS to High-Z t_{DF}

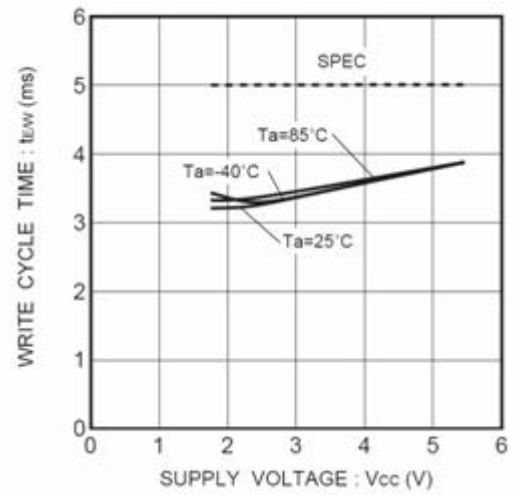

Figure 31. Write cycle time $t_{E/W}$

●Description of Operations

Communications of the Microwire Bus are carried out by SK (serial clock), DI (serial data input), DO (serial data output), and CS (chip select) for device selection.

When to connect one EEPROM to a microcontroller, connect it as shown in Figure 32 (a) or Figure 32 (b). When to use the input and output common I/O port of the microcontroller, connect DI and DO via a resistor as shown in Figure 31 (b) (Refer to page 19.), and connection by 3 lines is available.

In the case of plural connections, refer to Figure 32 (c).

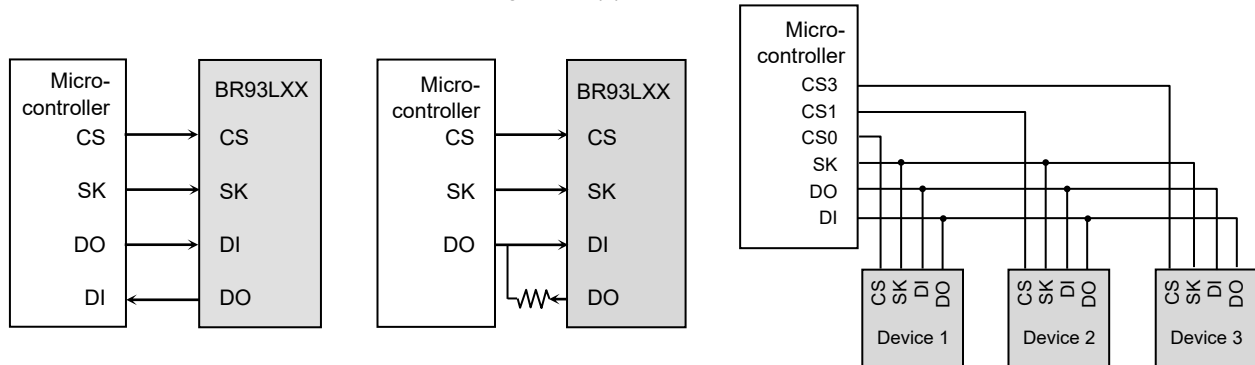

Figure 32-(a) Connection by 4 lines

Figure 32-(b) Connection by 3 lines

Figure 32-(c) Connection example of plural devices

Figure 32. Connection method with microcontroller

Communications of the Microwire Bus are started by the first “1” input after the rise of CS. This input is called a start bit. After input of the start bit, input ope code, address and data. Address and data are input all in MSB first manners.

“0” input after the rise of CS to the start bit input is all ignored. Therefore, when there is limitation in the bit width of PIO of the microcontroller, input “0” before the start bit input, to control the bit width.

●Command Mode

| Command | Start bit | Ope code | Address | | | Data |
|--------------------------------|-----------|----------|-------------------|-------------------------|-------------------------------|-----------------------|
| | | | BR93L46-W | BR93L56/66-W | BR93L76/86-W | |
| Read (READ) ^{*1} | 1 | 10 | A5,A4,A3,A2,A1,A0 | A7,A6,A5,A4,A3,A2,A1,A0 | A9,A8,A7,A6,A5,A4,A3,A2,A1,A0 | D15 to D0(READ DATA) |
| Write enable (WEN) | 1 | 00 | 1 1 **** | 1 1 ***** | 1 1 ***** | |
| Write (WRITE) ^{*2} | 1 | 01 | A5,A4,A3,A2,A1,A0 | A7,A6,A5,A4,A3,A2,A1,A0 | A9,A8,A7,A6,A5,A4,A3,A2,A1,A0 | D15 to D0(WRITE DATA) |
| Write all (WRAL) ^{*2} | 1 | 00 | 0 1 **** | 0 1 ***** | 0 1 ***** | D15 to D0(WRITE DATA) |
| Write disable (WDS) | 1 | 00 | 0 0 **** | 0 0 ***** | 0 0 ***** | |
| Erase (ERASE) | 1 | 11 | A5,A4,A3,A2,A1,A0 | A7,A6,A5,A4,A3,A2,A1,A0 | A9,A8,A7,A6,A5,A4,A3,A2,A1,A0 | |
| Chip erase (ERAL) | 1 | 00 | 1 0 **** | 1 0 ***** | 1 0 ***** | |

• Input the address and the data in MSB first manners.

• As for *, input either VIH or VIL.

*Start bit

Acceptance of all the commands of this IC starts at recognition of the start bit.

The start bit means the first “1” input after the rise of CS.

*1 As for read, by continuous SK clock input after setting the read command, data output of the set address starts, and address data in significant order are sequentially output continuously. (Auto increment function)

*2 When the read and the write all commands are executed, data written in the selected memory cell is automatically deleted, and input data is written.

A7 of BR93L56-W becomes Don't Care.

A9 of BR93L76-W becomes Don't Care.

●Timing Chart

1) Read cycle (READ)

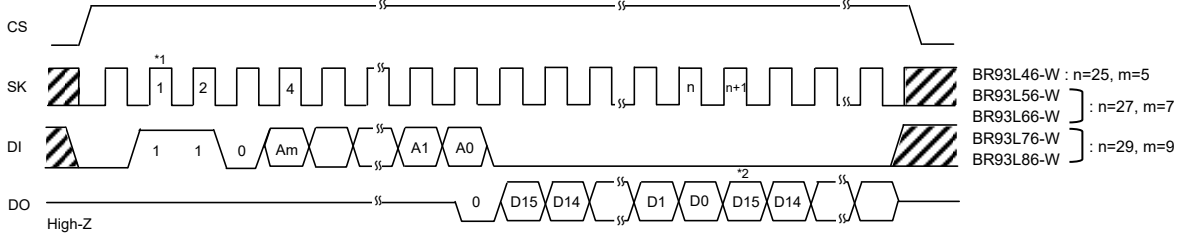

*1 Start bit

When data "1" is input for the first time after the rise of CS, this is recognized as a start bit. And when "1" is input after plural "0" are input, it is recognized as a start bit, and the following operation is started. This is common to all the commands to described hereafter.

Figure 33. Read cycle

○When the read command is recognized, input address data (16bit) is output to serial. And at that moment, at taking A0, in sync with the rise of SK, "0" (dummy bit) is output. And, the following data is output in sync with the rise of SK. This IC has an address auto increment function valid only at read command. This is the function where after the above read execution, by continuously inputting SK clock, the above address data is read sequentially. And, during the auto increment, keep CS at "H".

2) Write cycle (WRITE)

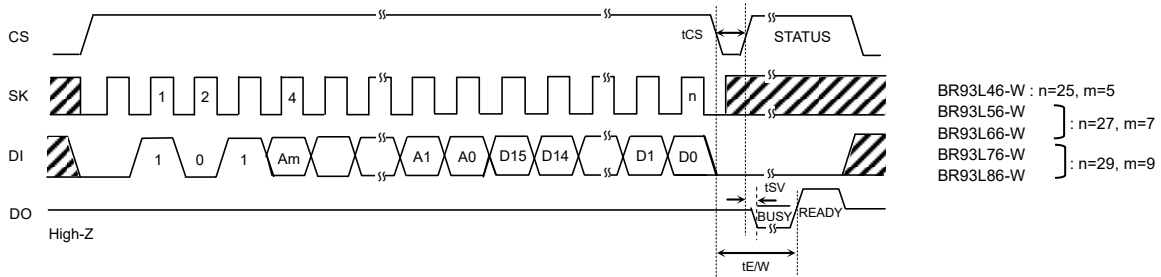

Figure 34. Write cycle

○In this command, input 16bit data (D15 to D0) are written to designated addresses (Am to A0). The actual write starts by the fall of CS of D0 taken SK clock. When STATUS is not detected, (CS="L" fixed) Max. 5ms in conformity with tE/W, and when STATUS is detected (CS="H"), all commands are not accepted for areas where "L" (BUSY) is output from DO, therefore, do not input any command.

3) Write all cycle (WRAL)

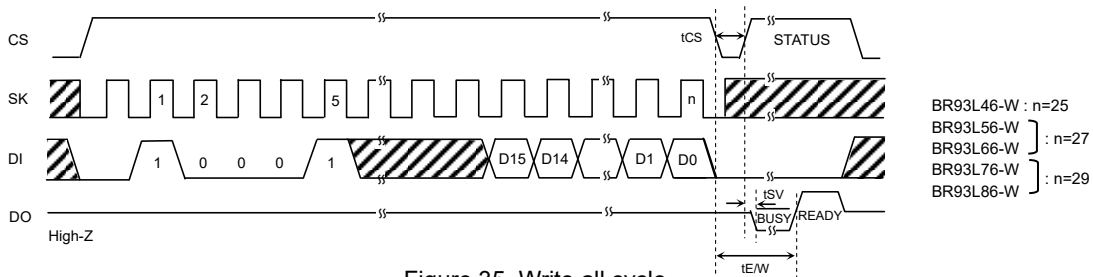

Figure 35. Write all cycle

○In this command, input 16bit data is written simultaneously to all addresses. Data is not written continuously per one word but is written in bulk, the write time is only Max. 5ms in conformity with tE/W.

4) Write enable (WEN) / disable (WDS) cycle

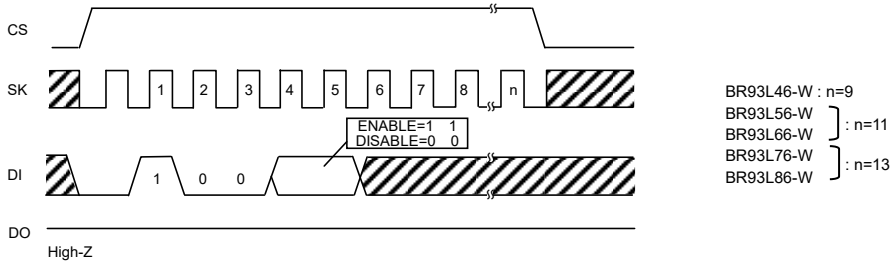

Figure 36. Write enable (WEN) / disable (WDS) cycle

- At power on, this IC is in write disable status by the internal RESET circuit. Before executing the write command, it is necessary to execute the write enable command. And, once this command is executed, it is valid until the write disable command is executed or the power is turned off. However, the read command is valid irrespective of write enable / disable command. Input to SK after 6 clocks of this command is available by either “H” or “L”, but be sure to input it.
- When the write enable command is executed after power on, write enable status gets in. When the write disable command is executed then, the IC gets in write disable status as same as at power on, and then the write command is canceled thereafter in software manner. However, the read command is executable. In write enable status, even when the write command is input by mistake, write is started. To prevent such a mistake, it is recommended to execute the write disable command after completion of write.

5) Erase cycle timing (ERASE)

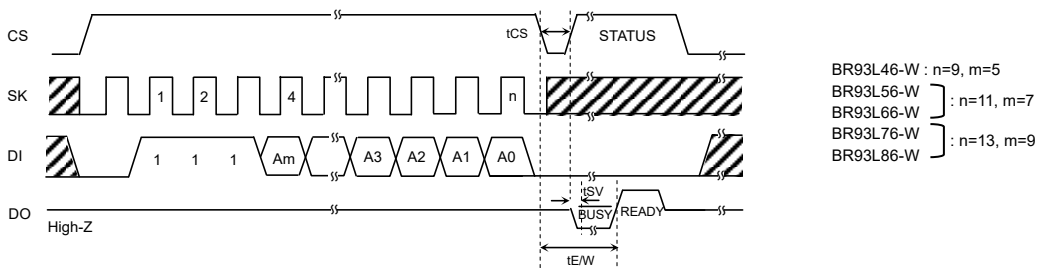

Figure 37. Erase cycle timing

- In this command, data of the designated address is made into “1”. The data of the designated address becomes “FFFFh”. Actual ERASE starts at the fall of CS after the fall of A0 taken SK clock. In ERASE, status can be detected in the same manner as in WRITE command.

6) Chip erase cycle timing (ERAL)

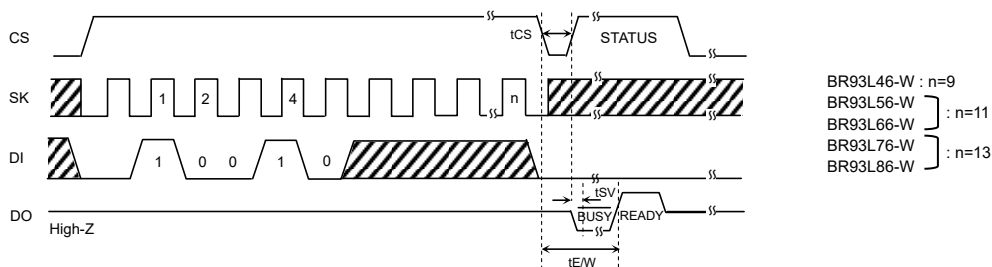

Figure 38. Chip erase cycle timing

- In this command, data of all addresses is erased. Data of all addresses becomes “FFFFh”. Actual ERASE starts at the fall of CS after the fall of the n-th clock from the start bit input. In ERAL, status can be detected in the same manner as in WRITE command.

●Application

1) Method to cancel each command

OREAD

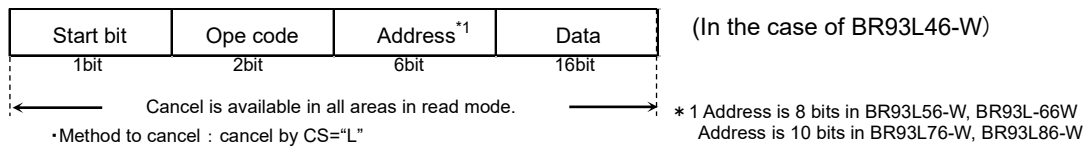

Figure 39. READ cancel available timing

OWRITE, WRAL

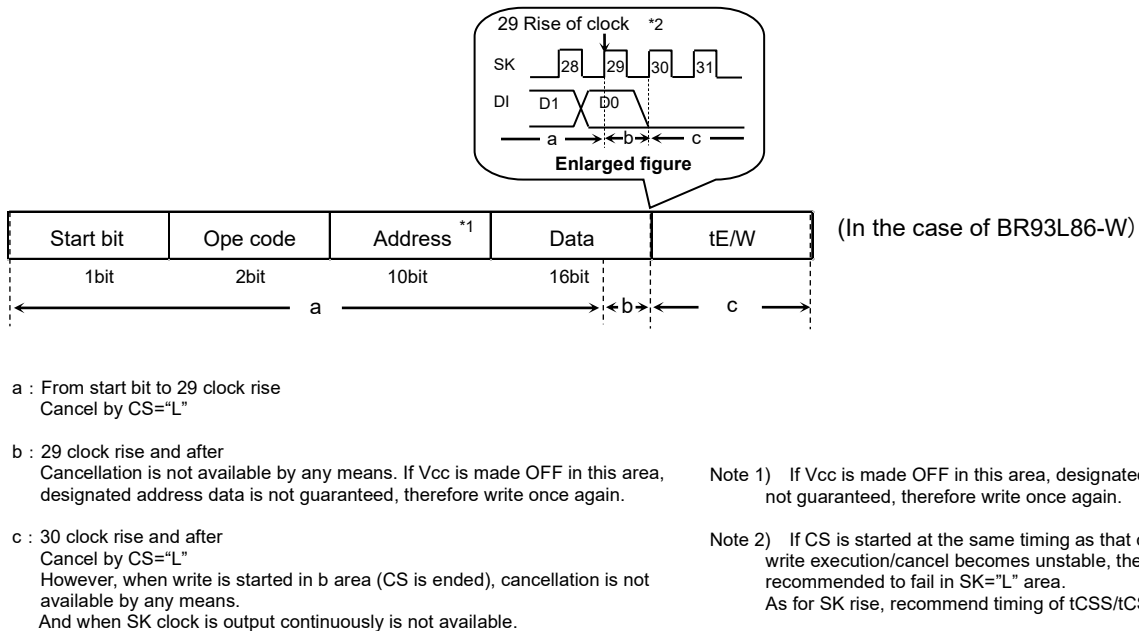
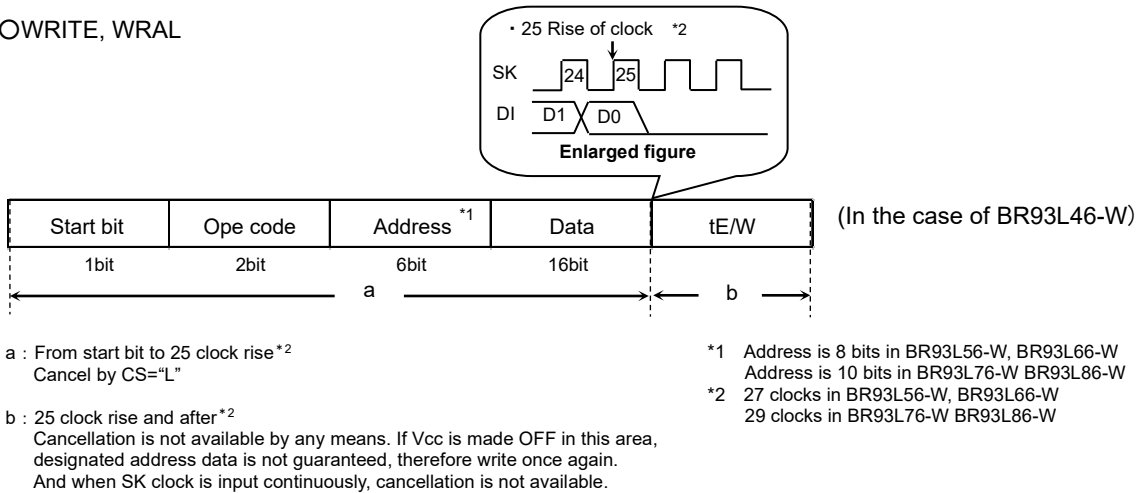
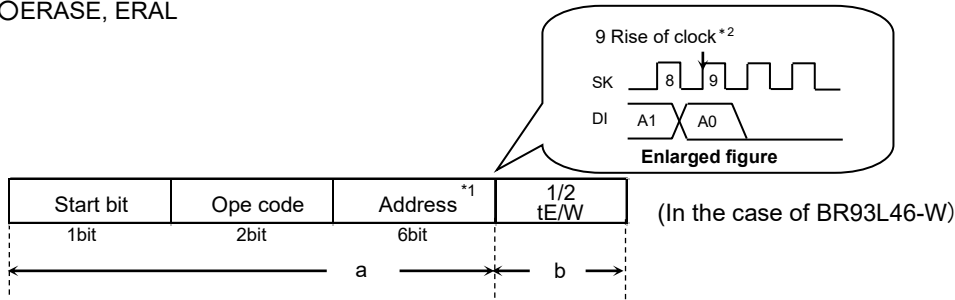

Figure 40. WRITE, WRAL cancel available timing

OERASE, ERAL



- a : From start bit to 9 clock rise*2
Cancel by CS="L"
- b : 9 clock rise and after*2
Cancellation is not available by any means. If Vcc is made OFF in this area, designated address data is not guaranteed, therefore write once again.
And when SK clock is input continuously, cancellation is not available.

- * 1 Address is 8 bits in BR93L56-W, BR93L66-W
Address is 10 bits in BR93L76-W
- * 2 11 clocks in BR93L56-W, BR93L66-W
13 clocks in BR93L76-W

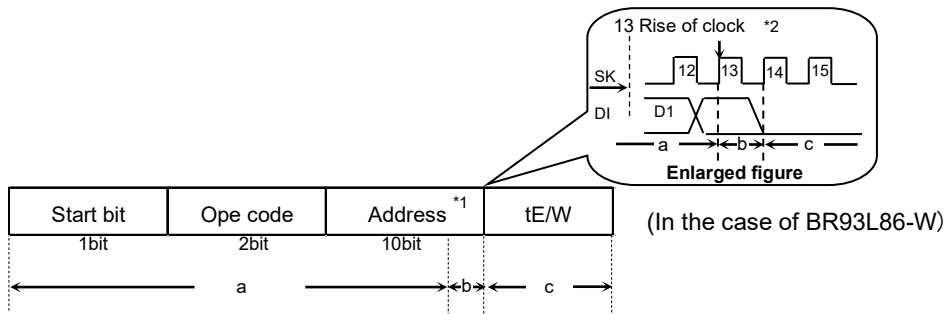

- a : From start bit to 13 clock rise
Cancel by CS="L"
- b : 13 clock rise and after
Cancellation is not available by any means. If Vcc is made OFF in this area, designated address data is not guaranteed, therefore write once again.
- c : 14 clock rise and after
Cancel by CS="L"
However, when write is started in b area (CS is ended), cancellation is not available by any means.
And when SK clock is output continuously is not available.

Note 1) If Vcc is made OFF in this area, designated address data is not guaranteed, therefore write once again.

Note 2) If CS is started at the same timing as that of the SK rise, write execution/cancel becomes unstable, therefore, it is recommended to fail in SK="L" area.
As for SK rise, recommend timing of tCSS/tCSH or higher.

Figure 41. ERASE, ERAL cancel available timing

2) At standby

○Standby current

When CS is "L", SK input is "L", DI input is "H", and even with middle electric potential, current does not increase.

○Timing

As shown in Figure 42, when SK at standby is "H", if CS is started, DI status may be read at the rise edge.

At standby and at power ON/OFF, when to start CS, set SK input or DI input to "L" status. (Refer to Figure 42)

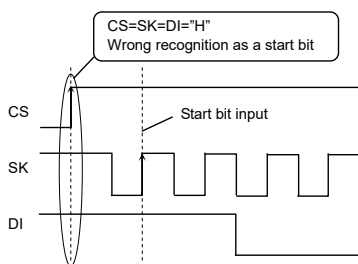

Figure 42. Wrong action timing

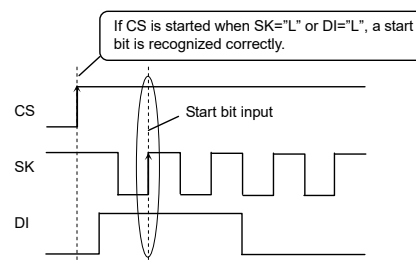

Figure 43. Normal action timing

3) Equivalent circuit

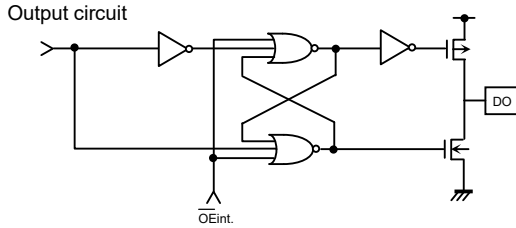

Figure 44. Output circuit (DO)

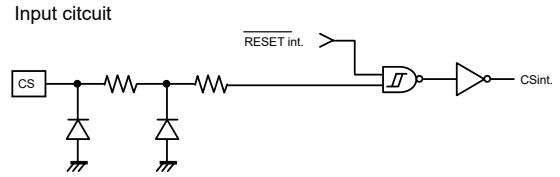

Figure 45. Input circuit (CS)

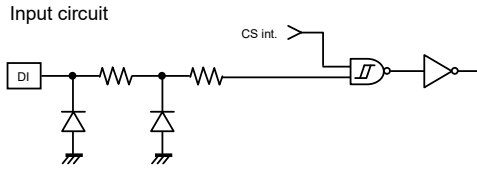

Figure 46. Input circuit (DI)

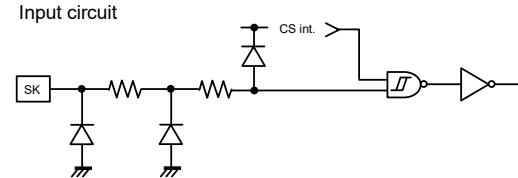

Figure 47. Input circuit (SK)

4) I/O peripheral circuit

4-1) Pull down CS.

By making CS="L" at power ON/OFF, mistake in operation and mistake write are prevented.

OPull down resistance Rpd of CS pin

To prevent mistake in operation and mistake write at power ON/OFF, CS pull down resistance is necessary. Select an appropriate value to this resistance value from microcontroller VOH, IOH, and VIL characteristics of this IC.

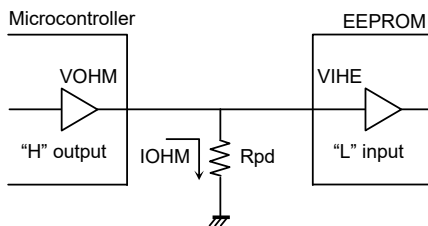

Figure 48. CS pull down resistance

$$R_{pd} \geq \frac{VO_{HM}}{IO_{HM}} \quad \dots \textcircled{1}$$

$$VO_{HM} \geq VI_{HE} \quad \dots \textcircled{2}$$

Example) When $V_{CC} = 5V$, $VI_{HE} = 2V$, $VO_{HM} = 2.4V$, $IO_{HM} = 2mA$, from the equation $\textcircled{1}$,

$$R_{pd} \geq \frac{2.4}{2 \times 10^{-3}}$$

$$\therefore R_{pd} \geq 1.2 [k\Omega]$$

With the value of Rpd to satisfy the above equation, VOHM becomes 2.4V or higher, and VIHE (=2.0V), the equation $\textcircled{2}$ is also satisfied.

- VIHE : EEPROM VIH specifications
- VOHM : Microcontroller VOH specifications
- IOHM : Microcontroller IOH specifications

4-2) DO is available in both pull up and pull down.

Do output become "High-Z" in other READY / BUSY output timing than after data output at read command and write command. When malfunction occurs at "High-Z" input of the microcontroller port connected to DO, it is necessary to pull down and pull up DO. When there is no influence upon the microcontroller actions, DO may be OPEN.

If DO is OPEN, and at timing to output status READY, at timing of CS="H", SK="H", DI="H", EEPROM recognizes this as a start bit, resets READY output, and DO="High-Z", therefore, READY signal cannot be detected. To avoid such output, pull up DO pin for improvement.

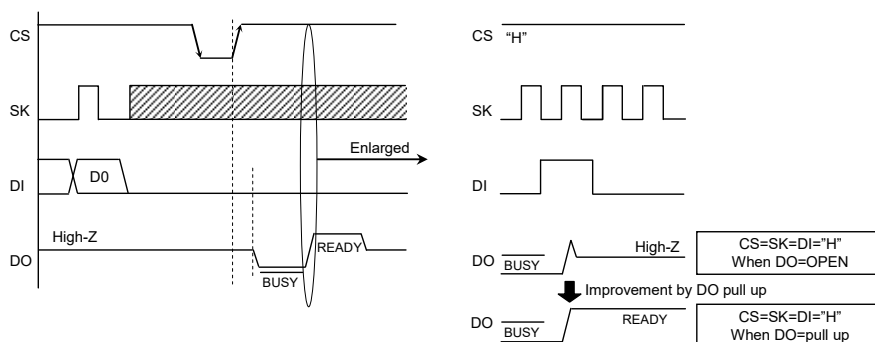

Figure 49. READY output timing at DO=OPEN

OPull up resistance R_{pu} and pull down resistance R_{pd} of DO pin

As for pull up and pull down resistance value, select an appropriate value to this resistance value from microcontroller V_{IH} , V_{IL} , and V_{OH} , I_{OH} , V_{OL} , I_{OL} characteristics of this IC.

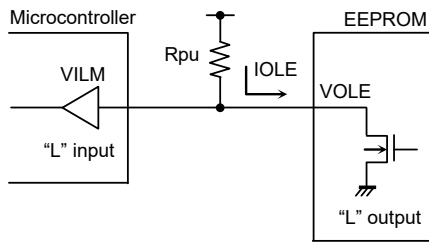

Figure 50. DO pull up resistance

$$R_{pu} \geq \frac{V_{cc} - V_{OLE}}{I_{OLE}} \quad \dots \textcircled{3}$$

$$V_{OLE} \leq V_{ILM} \quad \dots \textcircled{4}$$

Example) When $V_{cc} = 5V$, $V_{OLE} = 0.4V$, $I_{OLE} = 2.1mA$, $V_{ILM} = 0.8V$, from the equation $\textcircled{3}$,

$$R_{pu} \geq \frac{5 - 0.4}{2.1 \times 10^{-3}}$$

$$\therefore R_{pu} \geq 2.2 [k\Omega]$$

With the value of R_{pu} to satisfy the above equation, V_{OLE} becomes 0.4V or below, and with $V_{ILM} (= 0.8V)$, the equation $\textcircled{4}$ is also satisfied.

- V_{OLE} : EEPROM V_{OL} specifications
- I_{OLE} : EEPROM I_{OL} specifications
- V_{ILM} : Microcontroller V_{IL} specifications

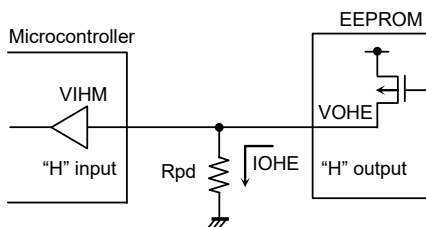

Figure 51. DO pull down resistance

$$R_{pd} \geq \frac{V_{OHE}}{I_{OHE}} \quad \dots \textcircled{5}$$

$$V_{OHE} \geq V_{IHM} \quad \dots \textcircled{6}$$

Example) When $V_{cc} = 5V$, $V_{OHE} = V_{cc} - 0.2V$, $I_{OHE} = 0.1mA$, $V_{IHM} = V_{cc} \times 0.7V$ from the equation $\textcircled{5}$,

$$R_{pd} \geq \frac{5 - 0.2}{0.1 \times 10^{-3}}$$

$$\therefore R_{pd} \geq 48 [k\Omega]$$

With the value of R_{pd} to satisfy the above equation, V_{OHE} becomes 2.4V or below, and with $V_{IHM} (= 3.5V)$, the equation $\textcircled{6}$ is also satisfied.

- V_{OHE} : EEPROM V_{OH} specifications
- I_{OHE} : EEPROM I_{OH} specifications
- V_{IHM} : Microcontroller V_{IH} specifications

5) \overline{RDY} / \overline{BUSY} status display (DO terminal)

(common to BR93L46-W, BR93L56-W, BR93L66-W, BR93L76-W, BR93L86-W)

This display outputs the internal status signal. When CS is started after t_{CS} (Min.200ns) from CS fall after write command input, "H" or "L" is output.

\overline{RDY} display = "L" (\overline{BUSY}) = write under execution

(DO status) After the timer circuit in the IC works and creates the period of $t_{E/W}$, this time circuit completes automatically.

And write to the memory cell is made in the period of $t_{E/W}$, and during this period, other command is not accepted.

\overline{RDY} display = "H" (READY) = command wait status

(DO status) Even after $t_{E/W}$ (max.5ms) from write of the memory cell, the following command is accepted.

Therefore, CS="H" in the period of $t_{E/W}$, and when input is in SK, DI, malfunction may occur, therefore, DI="L" in the area CS="H". (Especially, in the case of shared input port, attention is required.)

*Do not input any command while status signal is output. Command input in \overline{BUSY} area is cancelled, but command input in READY area is accepted. Therefore, status READY output is cancelled, and malfunction and mistake write may be made.

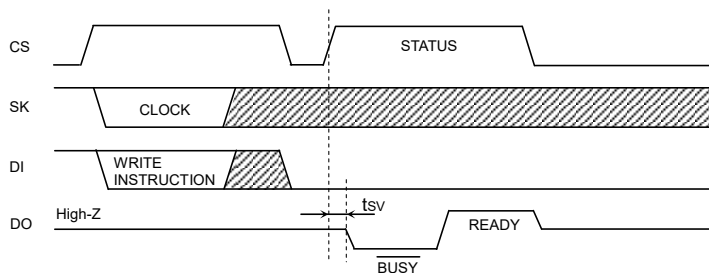

Figure 52. \overline{RDY} status output timing chart

6) When to directly connect DI and DO

This IC has independent input terminal DI and output terminal DO, and separate signals are handled on timing chart, meanwhile, by inserting a resistance R between these DI and DO terminals, it is possible to carry out control by 1 control line.

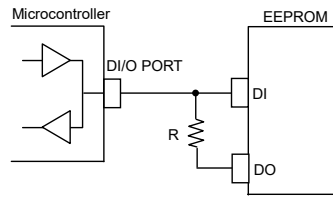

Figure 53. DI, DO control line common connection

○Data collision of microcontroller DI/O output and DO output and feedback of DO output to DI input.

Drive from the microcontroller DI/O output to DI input on I/O timing, and signal output from DO output occur at the same time in the following points.

(1) 1 clock cycle to take in A0 address data at read command

Dummy bit "0" is output to DO terminal.

→When address data A0 = "1" input, through current route occurs.

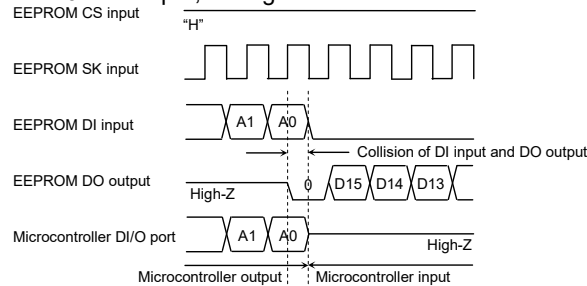

Figure 54. Collision timing at read data output at DI, DO direct connection

(2) Timing of CS = "H" after write command. DO terminal in READY / BUSY function output.

When the next start bit input is recognized, "HIGH-Z" gets in.

→Especially, at command input after write, when CS input is started with microcontroller DI/O output "L", READY output "H" is output from DO terminal, and through current route occurs.

Feedback input at timing of these (1) and (2) does not cause disorder in basic operations, if resistance R is inserted.

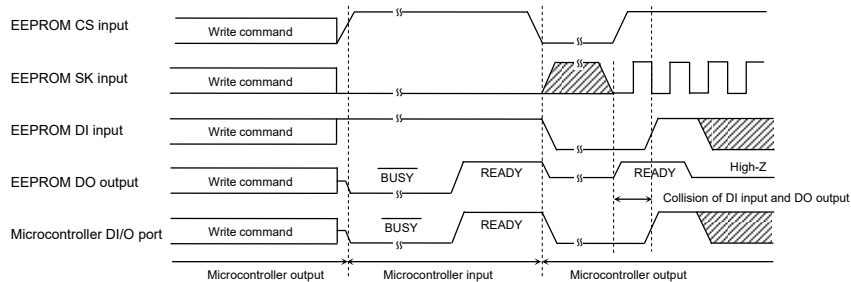

Figure 55. Collision timing at DI, DO direct connection

Note) As for the case (2), attention must be paid to the following.

When status READY is output, DO and DI are shared, DI="H" and the microcontroller DI/O="High-Z" or the microcontroller DI/O="H", if SK clock is input, DO output is input to DI and is recognized as a start bit, and malfunction may occur. As a method to avoid malfunction, at status READY output, set SK="L", or start CS within 4 clocks after "H" of READY signal is output.

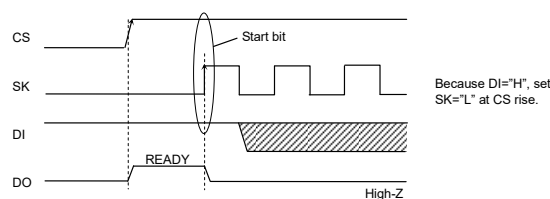

Figure 56. Start bit input timing at DI, DO direct connection

○ Selection of resistance value R

The resistance R becomes through current limit resistance at data collision. When through current flows, noises of power source line and instantaneous stop of power source may occur. When allowable through current is defined as I, the following relation should be satisfied. Determine allowable current amount in consideration of impedance and so forth of power source line in set. And insert resistance R, and set the value R to satisfy EEPROM input level VIH/VIL even under influence of voltage decline owing to leak current and so forth. Insertion of R will not cause any influence upon basic operations.

(1) Address data A0 = "1" input, dummy bit "0" output timing

(When microcontroller DI/O output is "H", EEPROM DO outputs "L", and "H" is input to DI)

- Make the through current to EEPROM 10mA or below.
- See to it that the level VIH of EEPROM should satisfy the following.

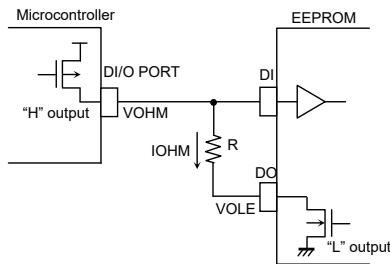

Conditions

$$VOHM \leq VIHE$$

$$VOHM \leq IOHM \times R + VOLE$$

At this moment, if $VOLE=0V$,

$$VOHM \leq IOHM \times R$$

$$\therefore R \geq \frac{VOHM}{IOHM} \quad \dots \textcircled{7}$$

- VIHE : EEPROM VIH specifications
- VOLE : EEPROM VOL specifications
- VOHM : Microcontroller VOH specifications
- IOHM : Microcontroller IOH specifications

Figure 57. Circuit at DI, DO direct connection (Microcontroller DI/O "H" output, EEPROM "L" output)

(2) DO status READY output timing

(When the microcontroller DI/O is "L", EEPROM DO output "H", and "L" is input to DI)

- Set the EEPROM input level VIL so as to satisfy the following.

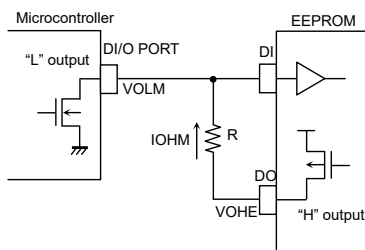

Conditions

$$VOLM \geq VILE$$

$$VOLM \geq VOHE - IOLM \times R$$

As this moment, $VOHE=V_{CC}$

$$VOLM \geq V_{CC} - IOLM \times R$$

$$\therefore R \geq \frac{V_{CC} - VOLM}{IOLM} \quad \dots \textcircled{8}$$

- VILE : EEPROM VIL specifications
- VOHE : EEPROM VOH specifications
- VOLM : Microcontroller VOL specifications
- IOLM : Microcontroller IOL specifications

Example) When $V_{CC}=5V$, $VOHM=5V$, $IOHM=0.4mA$, $VOLM=5V$, $IOLM=0.4mA$,

From the equation $\textcircled{7}$,

$$R \geq \frac{VOHM}{IOHM}$$

$$R \geq \frac{5}{0.4 \times 10^{-3}}$$

$$\therefore R \geq 12.5 \text{ [k}\Omega\text{]} \quad \dots \textcircled{9}$$

From the equation $\textcircled{8}$,

$$R \geq \frac{V_{CC} - VOLM}{IOLM}$$

$$R \geq \frac{5 - 0.4}{2.1 \times 10^{-3}}$$

$$\therefore R \geq 2.2 \text{ [k}\Omega\text{]} \quad \dots \textcircled{10}$$

Therefore, from the equations $\textcircled{9}$ and $\textcircled{10}$,

$$\therefore R \geq 12.5 \text{ [k}\Omega\text{]}$$

Figure 58. Circuit at DI, DO direct connection (Microcontroller DI/O "L" output, EEPROM "H" output)

7) Notes on power ON/OFF

- At power ON/OFF, set CS "L".

When CS is "H", this IC gets in input accept status (active). If power is turned on in this status, noises and the likes may cause malfunction, mistake write or so. To prevent these, at power ON, set CS "L". (When CS is in "L" status, all inputs are cancelled.) And at power decline, owing to power line capacity and so forth, low power status may continue long. At this case too, owing to the same reason, malfunction, mistake write may occur, therefore, at power OFF too, set CS "L".

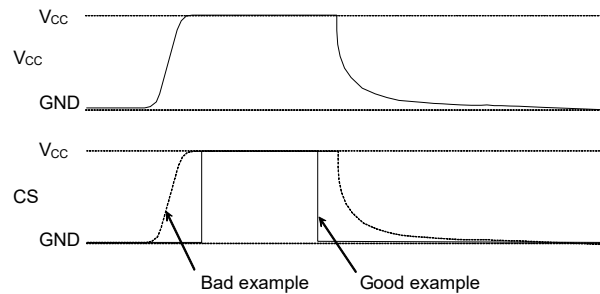

Figure 59. Timing at power ON/OFF

(Bad example) CS pin is pulled up to Vcc.

In this case, CS becomes "H" (active status), and EEPROM may have malfunction, mistake write owing to noise and the likes.

Even when CS input is High-Z, the status becomes like this case, which please note.

(Good example) It is "L" at power ON/OFF.

Set 10ms or higher to recharge at power OFF.

When power is turned on without observing this condition, IC internal circuit may not be reset, which please note.

OPOR circuit

This IC has a POR (Power On Reset) circuit as a mistake write countermeasure. After POR action, it gets in write disable status. The POR circuit is valid only when power is ON, and does not work when power is OFF. However, if CS is "H" at power ON/OFF, it may become write enable status owing to noises and the likes. For secure actions, observe the following conditions.

- Set CS="L"
- Turn on power so as to satisfy the recommended conditions of t_R , t_{OFF} , V_{bot} for POR circuit action.

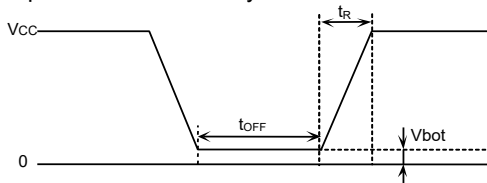

Figure 60. Rise waveform diagram

Recommended conditions of t_R , t_{OFF} , V_{bot}

| t_R | t_{OFF} | V_{bot} |
|----------------|----------------|---------------|
| 10ms or below | 10ms or higher | 0.3V or below |
| 100ms or below | 10ms or higher | 0.2V or below |

OLVCC circuit

LVCC (VCC-Lockout) circuit prevents data rewrite action at low power, and prevents wrong write.

At LVCC voltage (Typ.=1.2V) or below, it prevent data rewrite.

8) Noise countermeasures

OVcc noise (bypass capacitor)

When noise or surge gets in the power source line, malfunction may occur, therefore, for removing these, it is recommended to attach a by pass capacitor (0.1 μ F) between IC Vcc and GND, At that moment, attach it as close to IC as possible. And, it is also recommended to attach a bypass capacitor between board Vcc and GND.

OSK noise

When the rise time (t_R) of SK is long, and a certain degree or more of noise exists, malfunction may occur owing to clock bit displacement. To avoid this, a Schmitt trigger circuit is built in SK input. The hysteresis width of this circuit is set about 0.2V, if noises exist at SK input, set the noise amplitude 0.2Vp-p or below. And it is recommended to set the rise time (t_R) of SK 100ns or below. In the case when the rise time is 100ns or higher, take sufficient noise countermeasures. Make the clock rise, fall time as small as possible.

●Notes for Use

- (1) Described numeric values and data are design representative values, and the values are not guaranteed.
- (2) We believe that application circuit examples are recommendable, however, in actual use, confirm characteristics further sufficiently. In the case of use by changing the fixed number of external parts, make your decision with sufficient margin in consideration of static characteristics and transition characteristics and fluctuations of external parts and our IC.
- (3) Absolute Maximum Ratings
If the absolute maximum ratings such as impressed voltage and action temperature range and so forth are exceeded, IC may be destructed. Do not impress voltage and temperature exceeding the absolute maximum ratings. In the case of fear exceeding the absolute maximum ratings, take physical safety countermeasures such as fuses, and see to it that conditions exceeding the absolute maximum ratings should not be impressed to IC.
- (4) GND electric potential
Set the voltage of GND terminal lowest at any action condition. Make sure that each terminal voltage is not lower than that of GND terminal in consideration of transition status.
- (5) Heat design
In consideration of allowable loss in actual use condition, carry out heat design with sufficient margin.
- (6) Terminal to terminal shortcircuit and wrong packaging
When to package IC onto a board, pay sufficient attention to IC direction and displacement. Wrong packaging may destruct IC. And in the case of shortcircuit between IC terminals and terminals and power source, terminal and GND owing to foreign matter, IC may be destructed.
- (7) Use in a strong electromagnetic field may cause malfunction, therefore, evaluate design sufficiently

Status of this document

The Japanese version of this document is formal specification. A customer may use this translation version only for a reference to help reading the formal version.

If there are any differences in translation version of this document formal version takes priority.

● Ordering Information Product Code Description

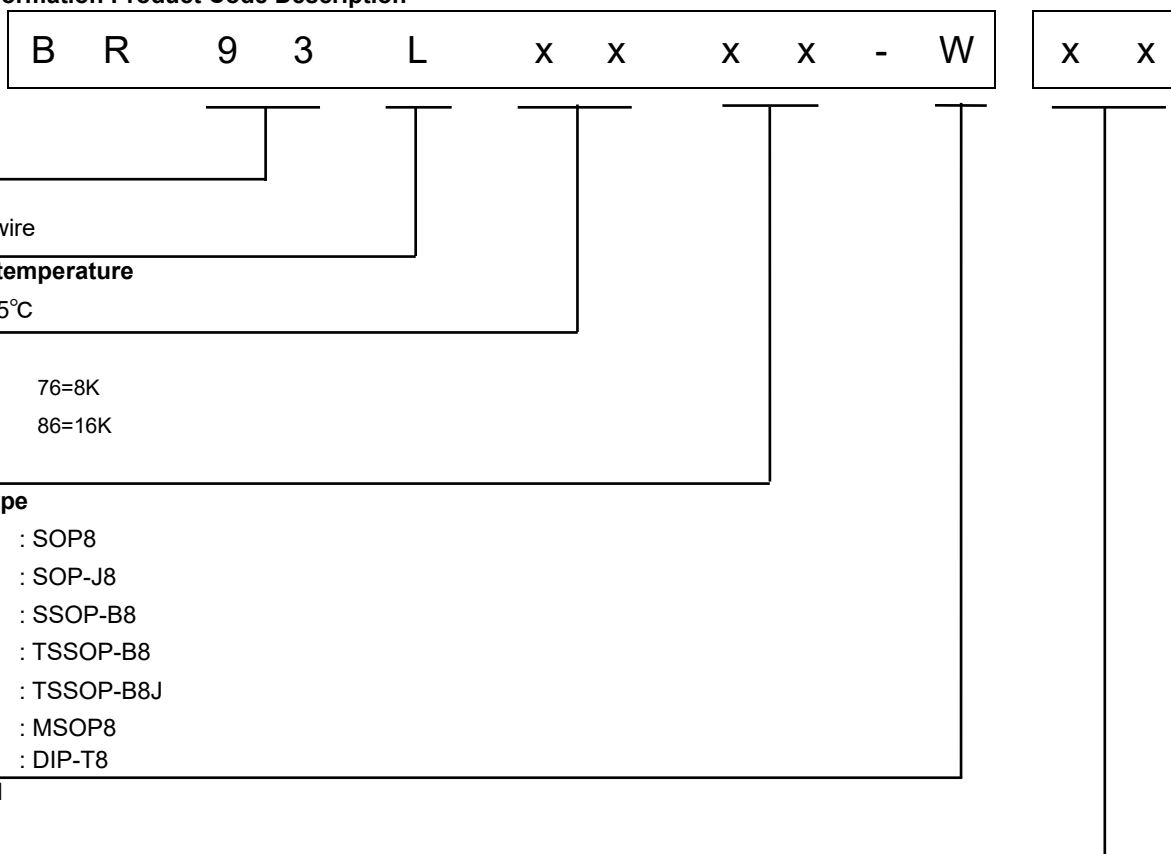

●Physical Dimension Tape and Reel Information

SOP8

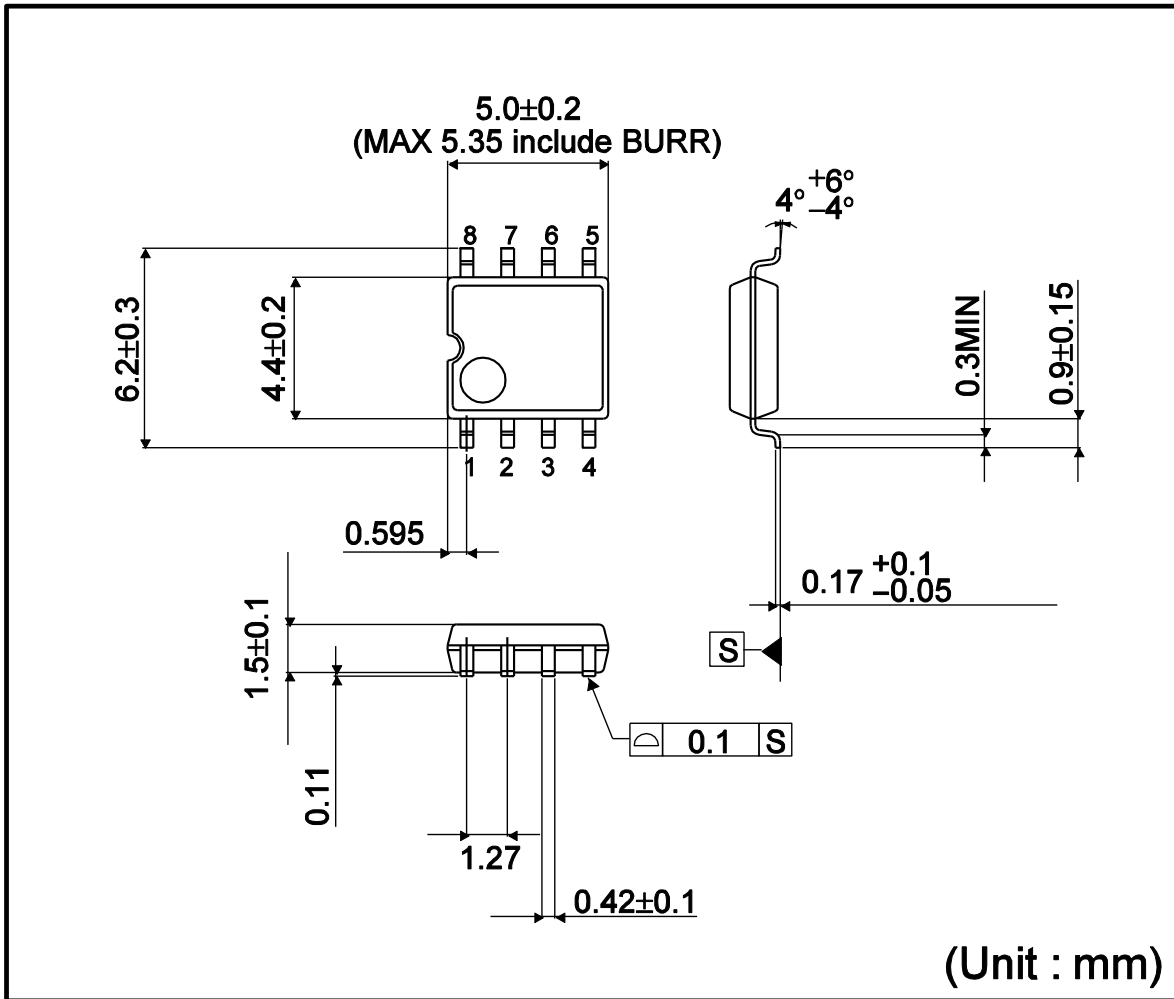

<Tape and Reel information>

| | |
|-------------------|--|
| Tape | Embossed carrier tape |
| Quantity | 2500pcs |
| Direction of feed | E2 (The direction is the 1 pin of product is at the upper left when you hold reel on the left hand and you pull out the tape on the right hand) |

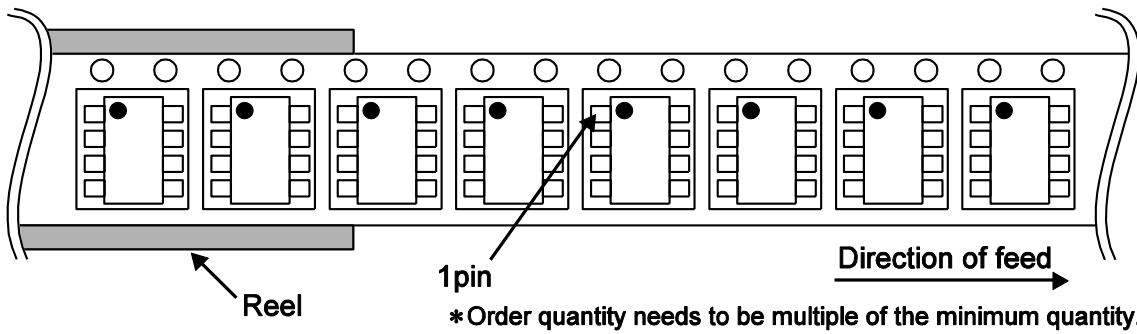

●Physical Dimension Tape and Reel Information - Continued

SOP-J8

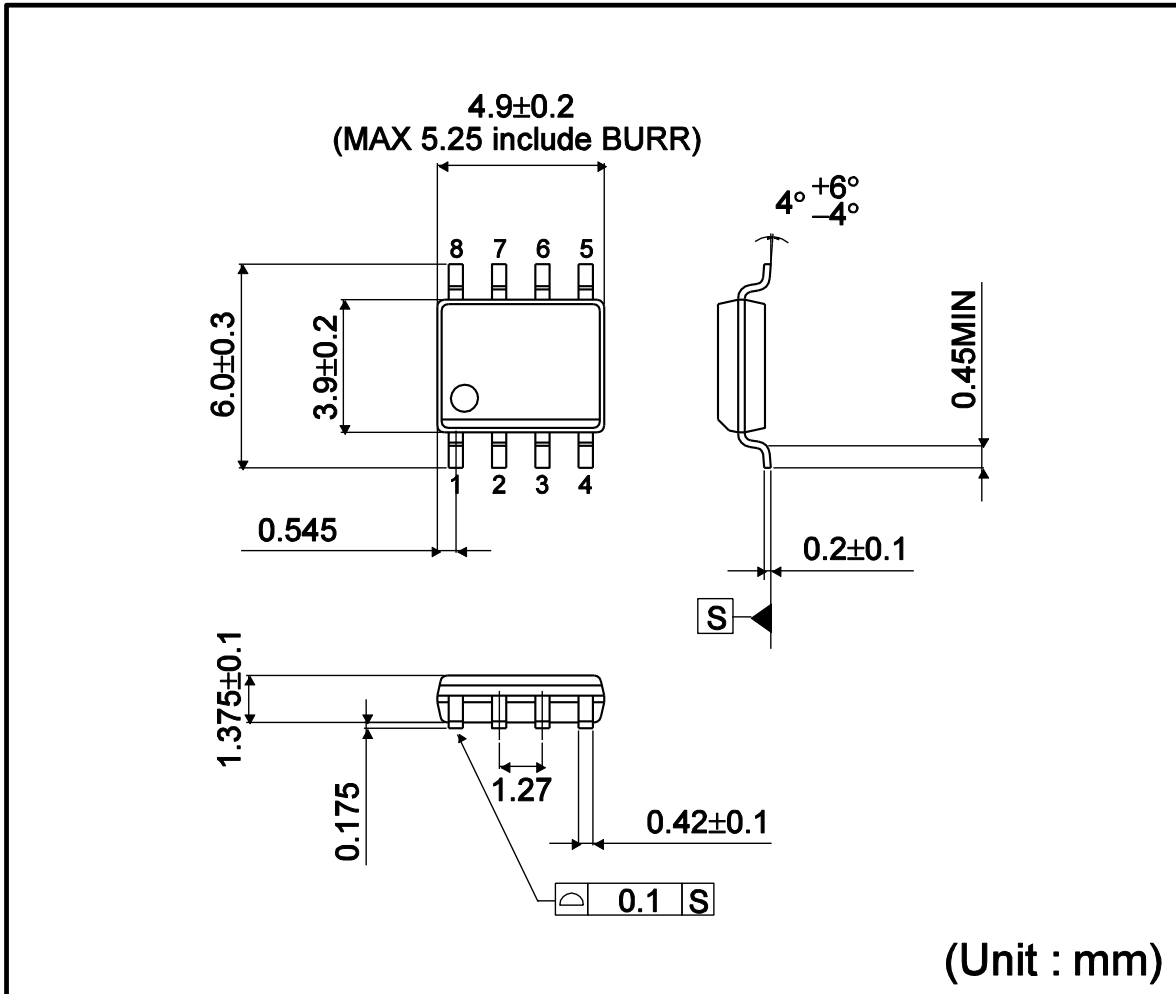

<Tape and Reel information>

| | |
|-------------------|--|
| Tape | Embossed carrier tape |
| Quantity | 2500pcs |
| Direction of feed | E2 (The direction is the 1 pin of product is at the upper left when you hold reel on the left hand and you pull out the tape on the right hand) |

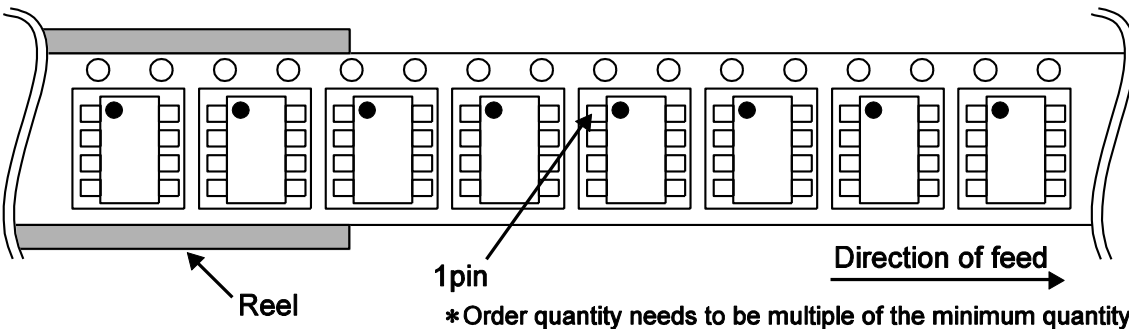

●Physical Dimension Tape and Reel Information – Continued

SSOP-B8

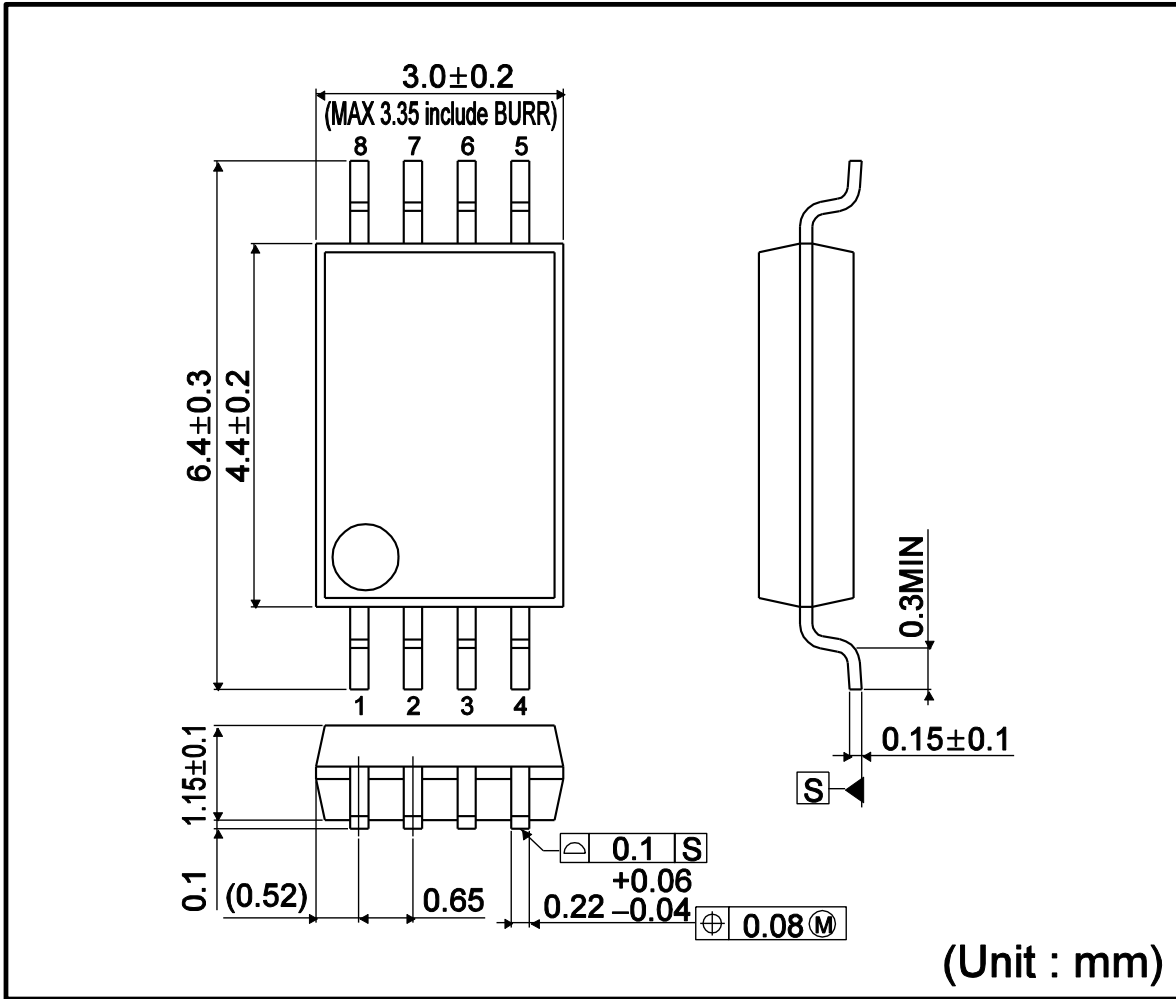

<Tape and Reel information>

| | |
|-------------------|---|
| Tape | Embossed carrier tape |
| Quantity | 2500pcs |
| Direction of feed | E2 (The direction is the 1pin of product is at the upper left when you hold reel on the left hand and you pull out the tape on the right hand) |

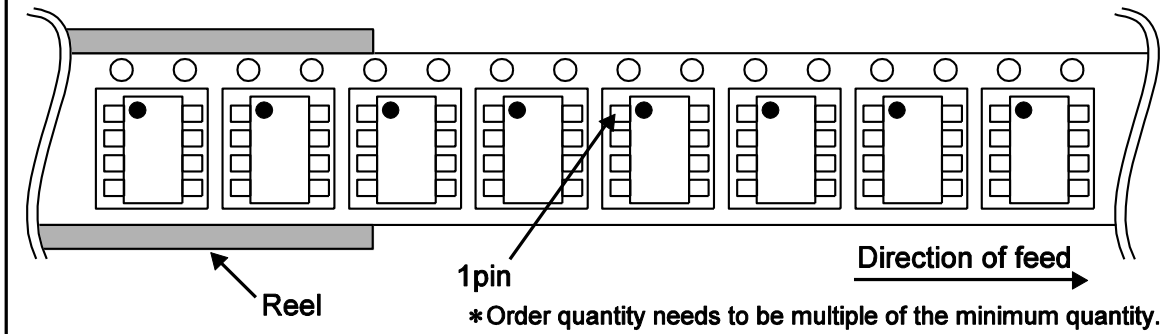

●Physical Dimension Tape and Reel Information – Continued

TSSOP-B8J

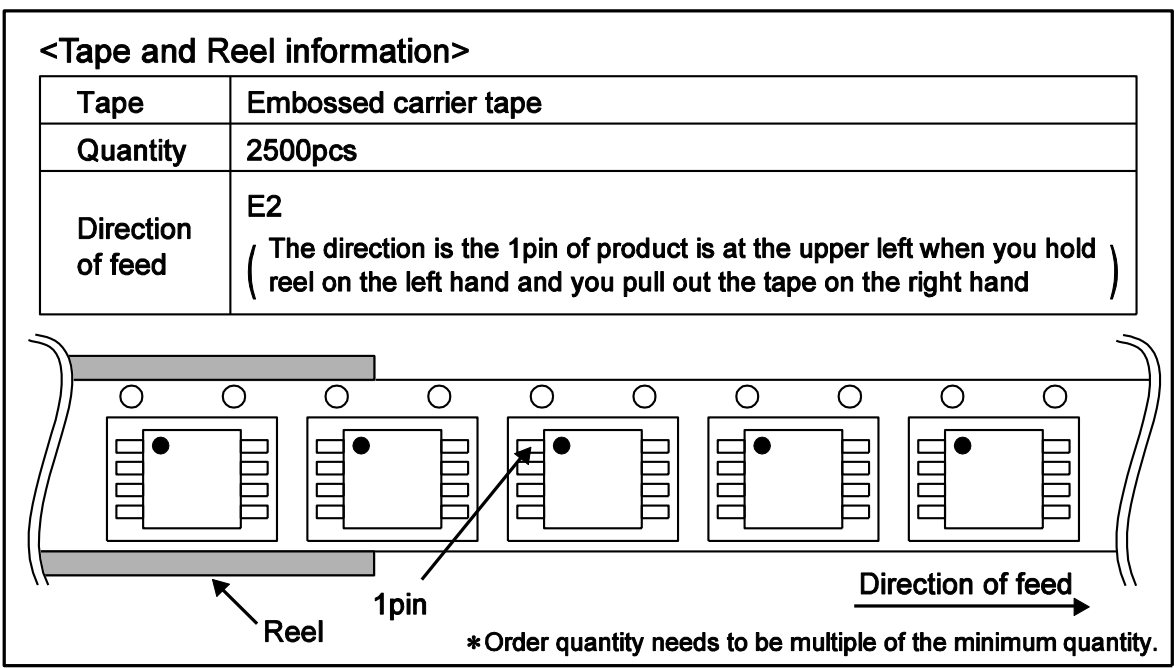
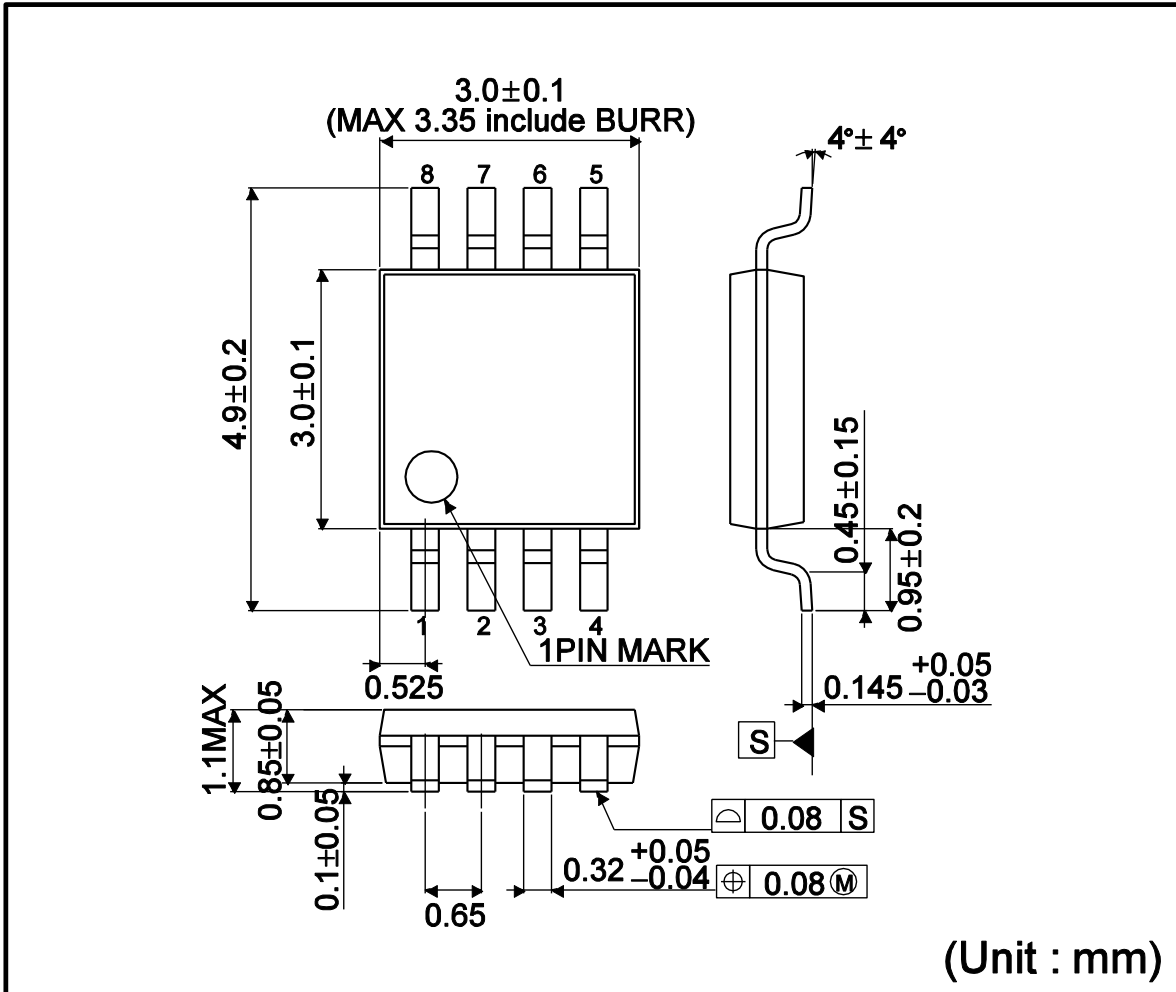

●Physical Dimension Tape and Reel Information – Continued

TSSOP-B8

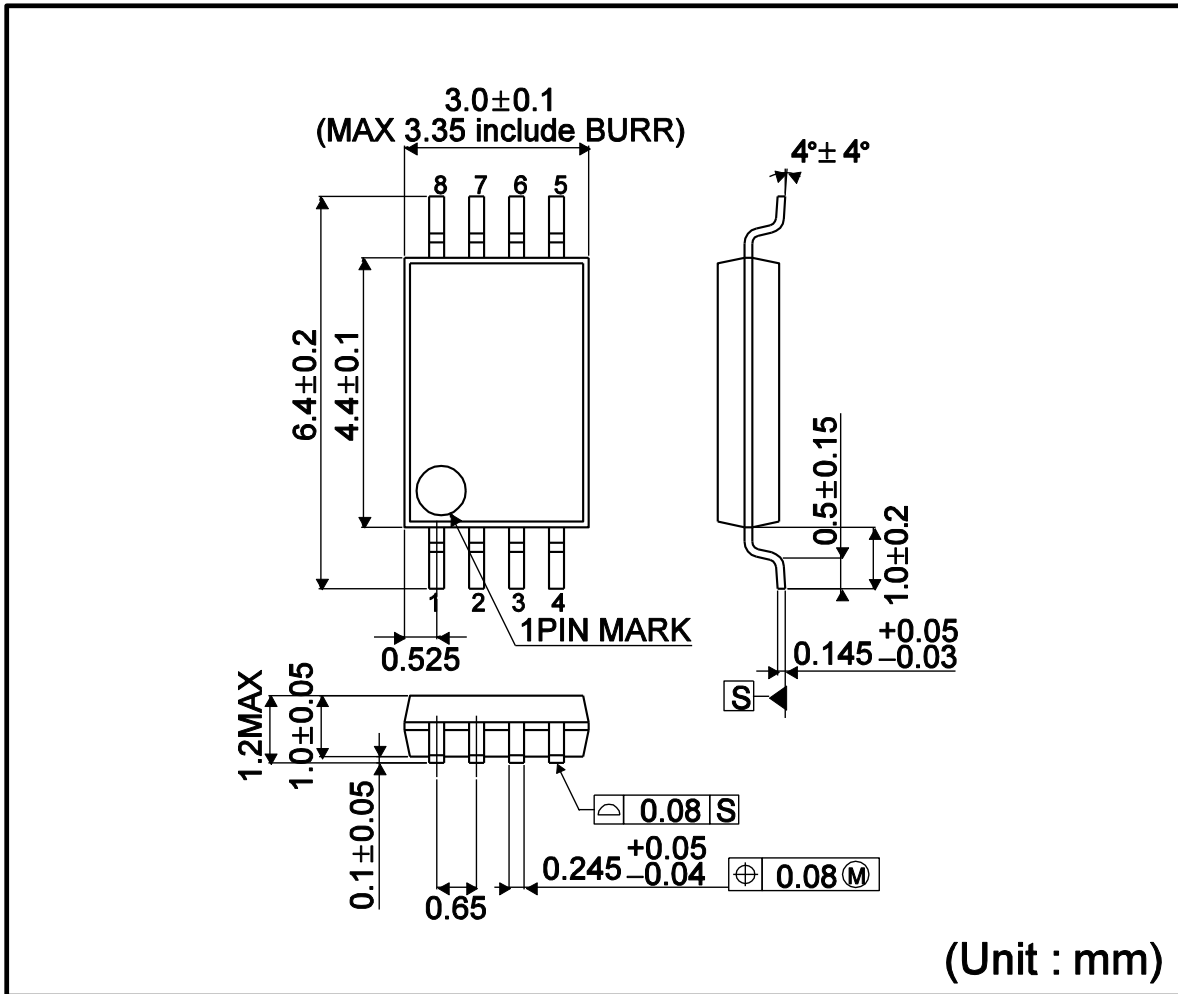

<Tape and Reel information>

| | |
|-------------------|--|
| Tape | Embossed carrier tape |
| Quantity | 3000pcs |
| Direction of feed | E2 (The direction is the 1 pin of product is at the upper left when you hold reel on the left hand and you pull out the tape on the right hand) |

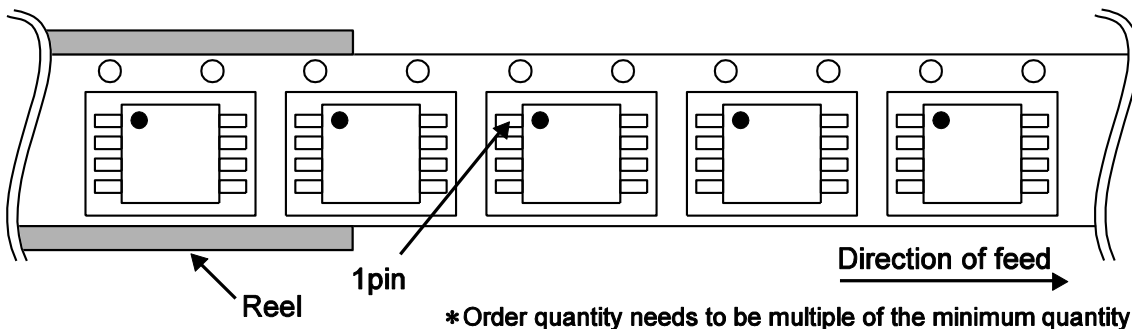

●Physical Dimension Tape and Reel Information – Continued

MSOP8

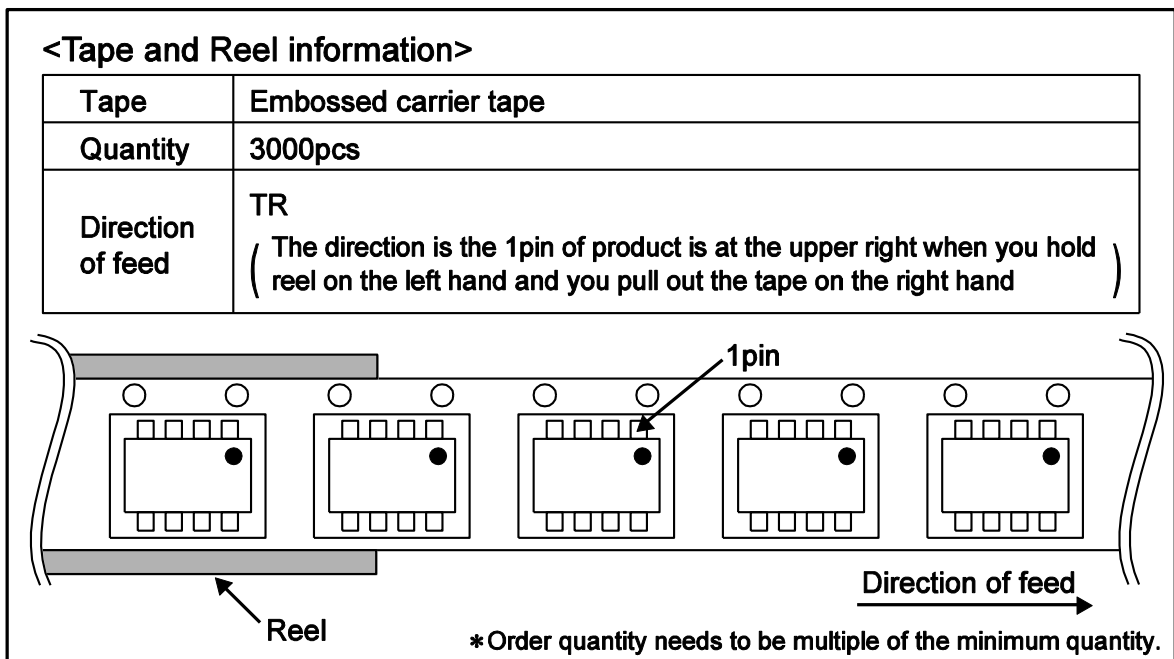
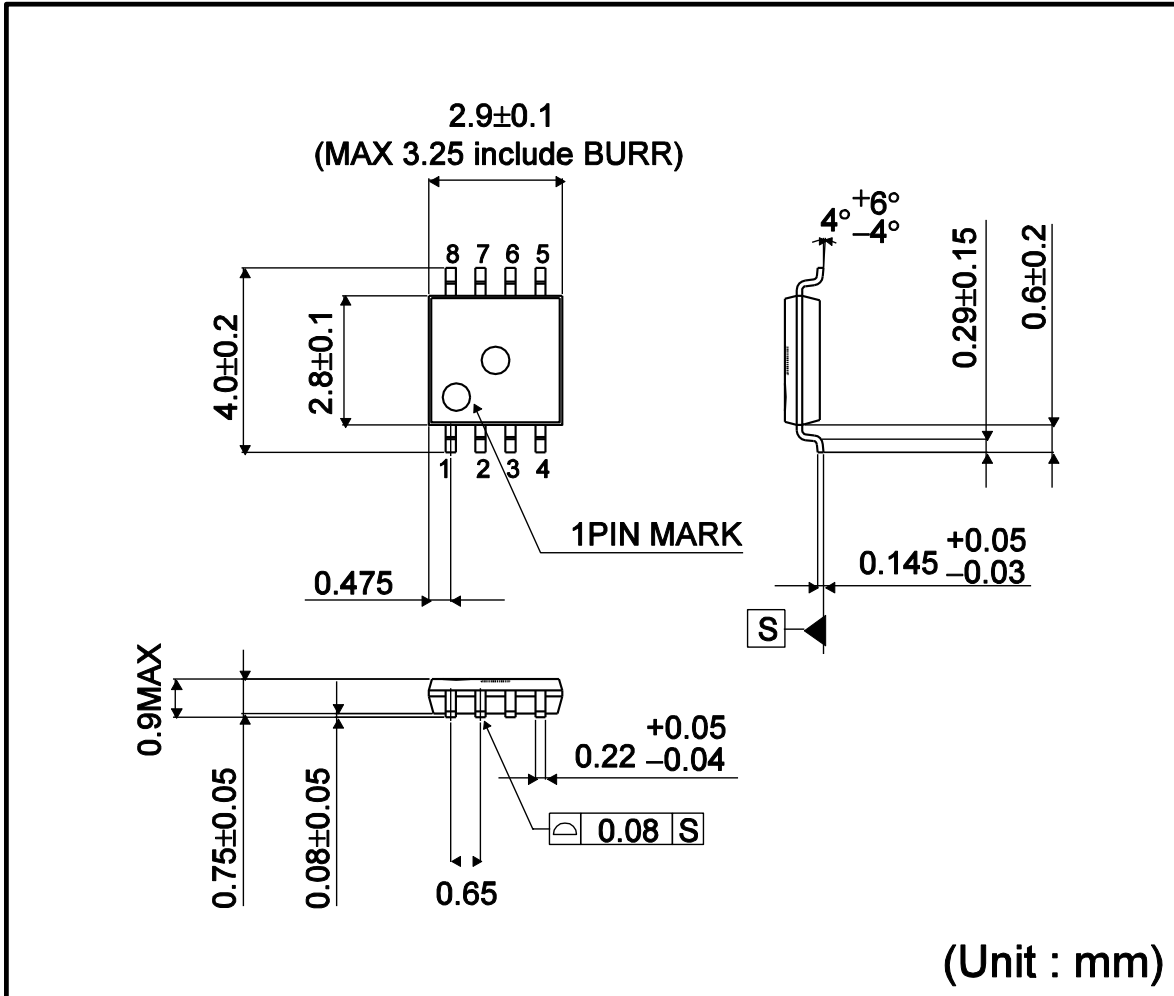

●Physical Dimension Tape and Reel Information – Continued

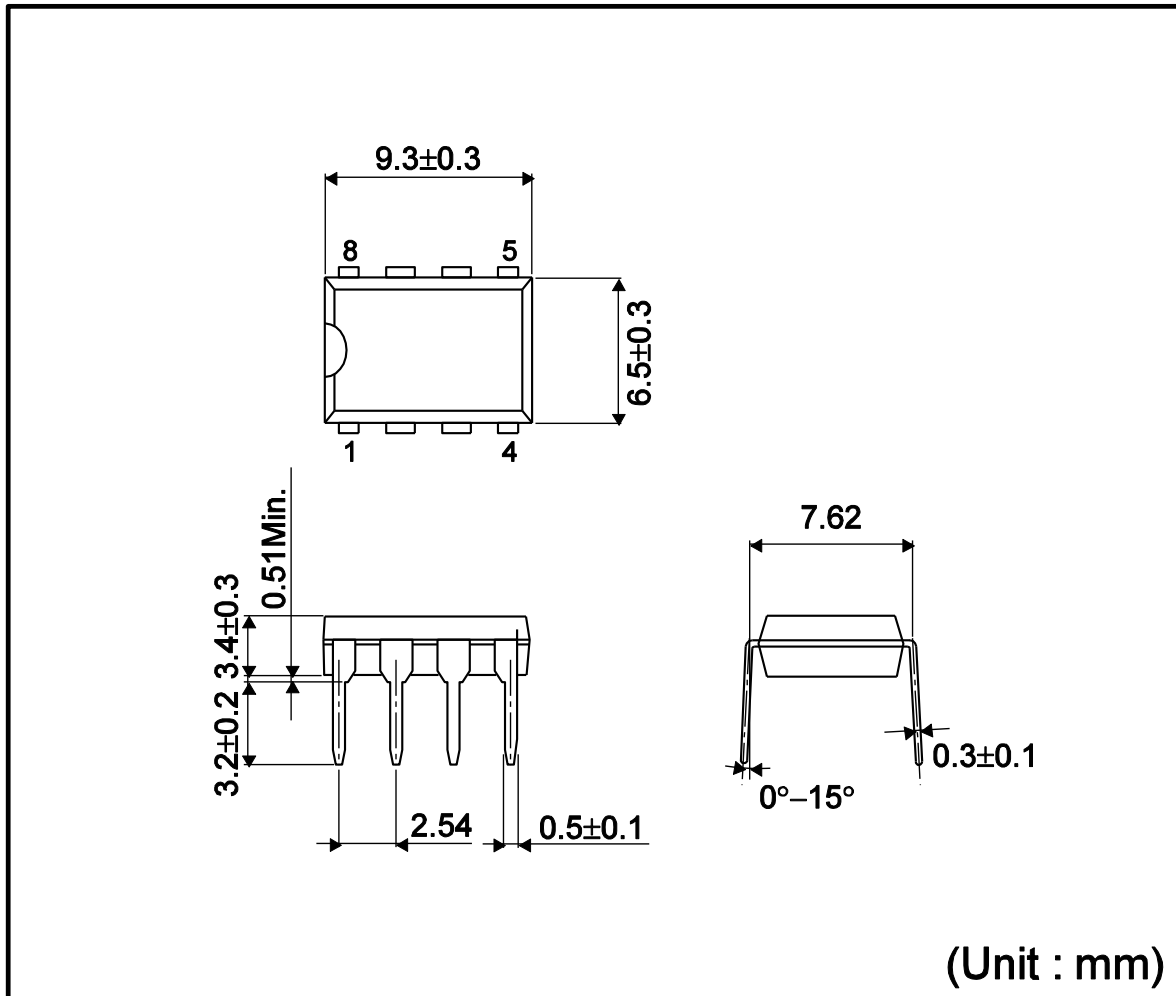
DIP-T8

<Tape and Reel information>

| | |
|-------------------|--|
| Container | Tube |
| Quantity | 2000pcs |
| Direction of feed | Direction of products is fixed in a container tube |

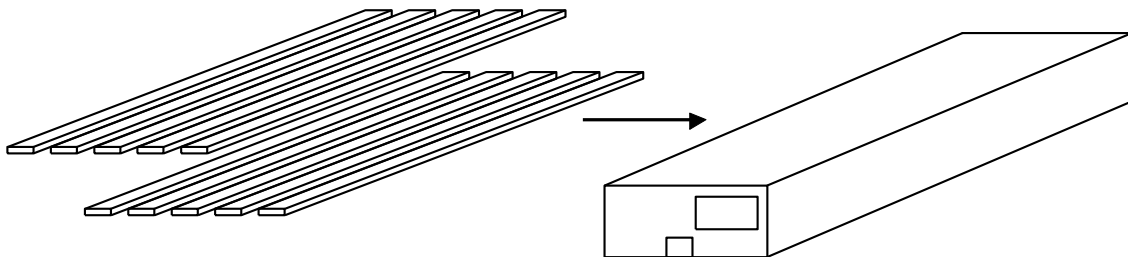

* Order quantity needs to be multiple of the minimum quantity.

● Marking Diagrams

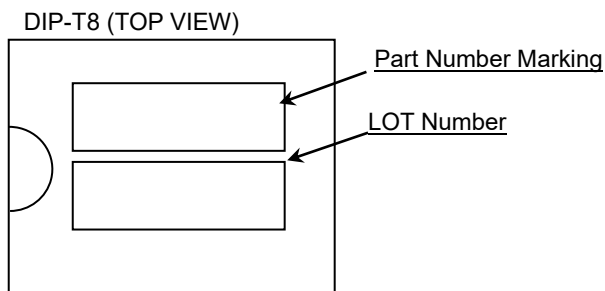
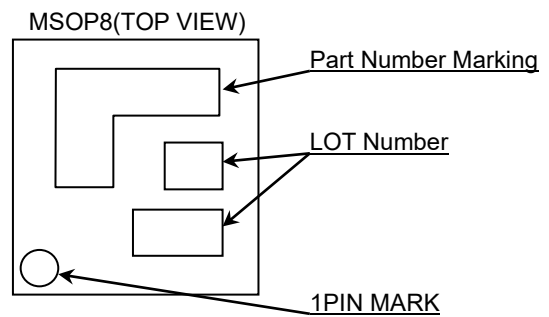
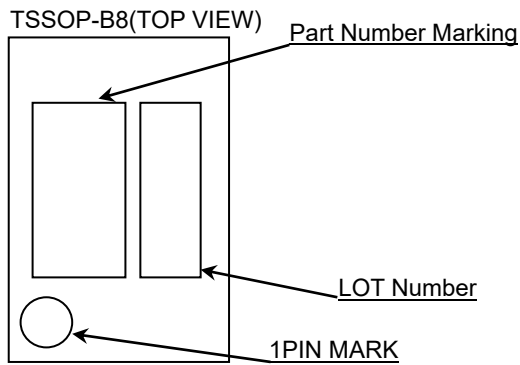
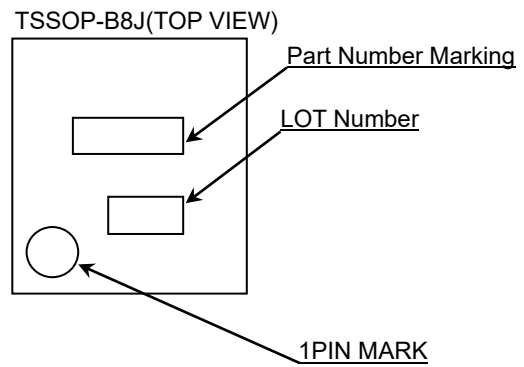
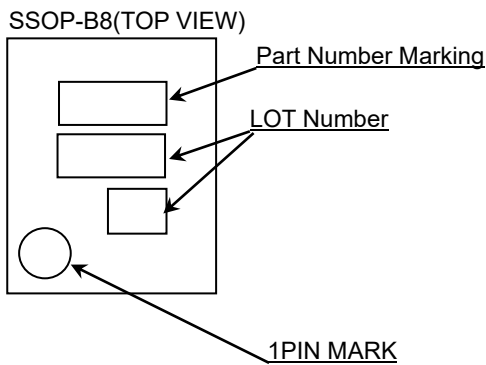
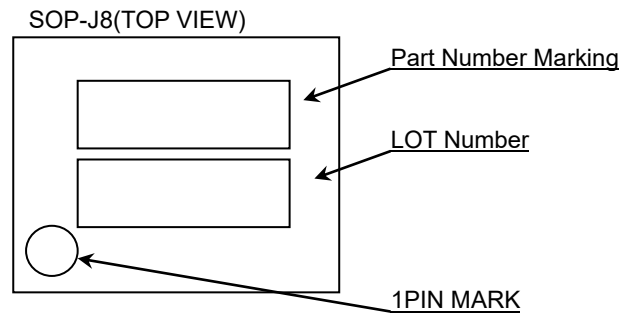
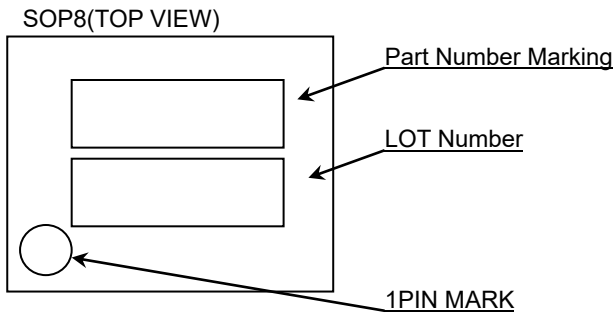

● Marking Information

| Capacity | Product Name Marking | Package Type | Orderable Part Number |
|----------|----------------------|--------------|-----------------------|
| 1K | L46 | SOP8 | BR93L46F -WE2 |
| | RL46 | | BR93L46RF -WE2 |
| | L46 | SOP-J8 | BR93L46FJ -WE2 |
| | RL46 | | BR93L46RFJ -WE2 |
| | L46 | SSOP-B8 | BR93L46FV -WE2 |
| | RL46 | | BR93L46RFV -WE2 |
| | R46 | TSSOP-B8J | BR93L46RFVJ -WE2 |
| | L46 | TSSOP-B8 | BR93L46FVT -WE2 |
| | RL46 | | BR93L46RFVT -WE2 |
| | R46 | MSOP8 | BR93L46RFVM -WTR |
| BR93L46 | DIP-T8 | BR93L46 -W | |
| 2K | L56 | SOP8 | BR93L56F -WE2 |
| | RL56 | | BR93L56RF -WE2 |
| | L56 | SOP-J8 | BR93L56FJ -WE2 |
| | RL56 | | BR93L56RFJ -WE2 |
| | L56 | SSOP-B8 | BR93L56FV -WE2 |
| | RL56 | | BR93L56RFV -WE2 |
| | R56 | TSSOP-B8J | BR93L56RFVJ -WE2 |
| | L56 | TSSOP-B8 | BR93L56FVT -WE2 |
| | RL56 | | BR93L56RFVT -WE2 |
| | R56 | MSOP8 | BR93L56RFVM -WTR |
| BR93L56 | DIP-T8 | BR93L56 -W | |
| 4K | L66 | SOP8 | BR93L66F -WE2 |
| | RL66 | | BR93L66RF -WE2 |
| | L66 | SOP-J8 | BR93L66FJ -WE2 |
| | RL66 | | BR93L66RFJ -WE2 |
| | L66 | SSOP-B8 | BR93L66FV -WE2 |
| | RL66 | | BR93L66RFV -WE2 |
| | R66 | TSSOP-B8J | BR93L66RFVJ -WE2 |
| | L66 | TSSOP-B8 | BR93L66FVT -WE2 |
| | RL66 | | BR93L66RFVT -WE2 |
| | R66 | MSOP8 | BR93L66RFVM -WTR |
| BR93L66 | DIP-T8 | BR93L66 -W | |
| 8K | L76 | SOP8 | BR93L76F -WE2 |
| | RL76 | | BR93L76RF -WE2 |
| | L76 | SOP-J8 | BR93L76FJ -WE2 |
| | RL76 | | BR93L76RFJ -WE2 |
| | RL76 | SSOP-B8 | BR93L76RFV -WE2 |
| | R76 | TSSOP-B8J | BR93L76RFVJ -WE2 |
| | RL76 | TSSOP-B8 | BR93L76RFVT -WE2 |
| | R76 | MSOP8 | BR93L76RFVM -WTR |
| BR93L76 | DIP-T8 | BR93L76 -W | |
| 16K | L86 | SOP8 | BR93L86F -WE2 |
| | RL86 | | BR93L86RF -WE2 |
| | L86 | SOP-J8 | BR93L86FJ -WE2 |
| | RL86 | | BR93L86RFJ -WE2 |
| | RL86 | SSOP-B8 | BR93L86RFV -WE2 |
| | R86 | TSSOP-B8J | BR93L86RFVJ -WE2 |
| | RL86 | TSSOP-B8 | BR93L86RFVT -WE2 |
| | R86 | MSOP8 | BR93L86RFVM -WTR |
| BR93L86 | DIP-T8 | BR93L86 -W | |

*1 Last Time Buy

● Revision History

| Date | Revision | Changes |
|-------------|----------|--|
| 31.Aug.2012 | 001 | New Release |
| 15.Oct.2013 | 002 | Page34 Modify the Marking of MSOP8 package of 8K and 16K |
| 08.Jan.2021 | 003 | Updated packages and part numbers |
| 15.Nov.2021 | 004 | P.1 Added description about Last Time Buy |

Part Numbering

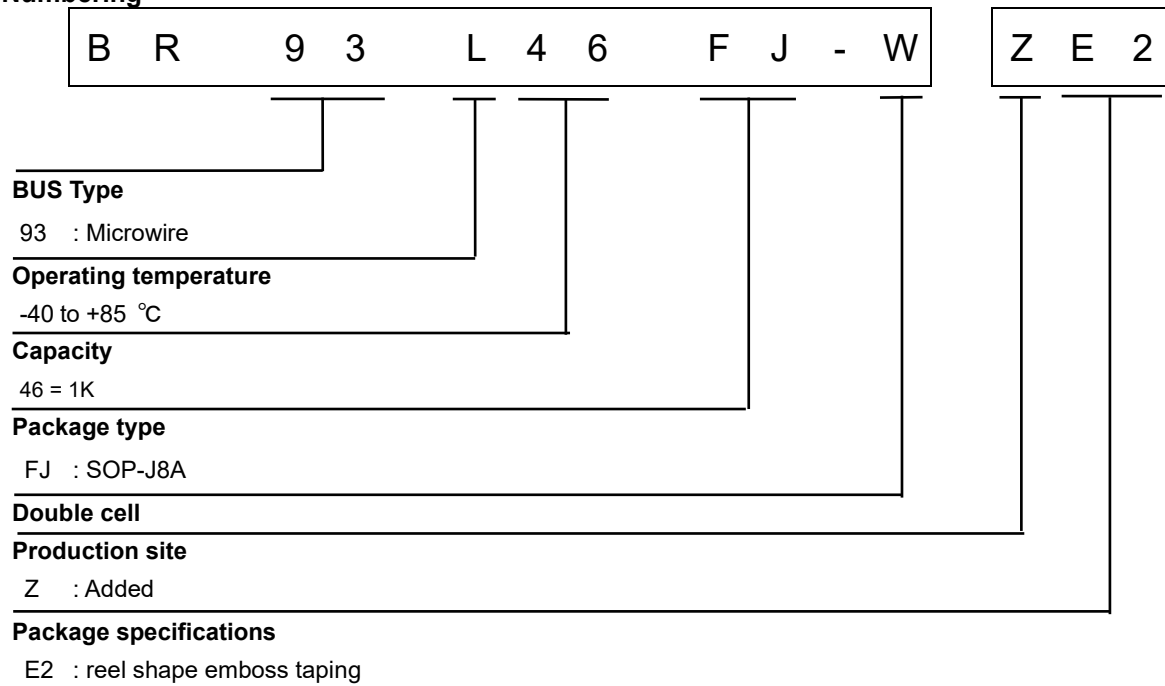

● **Marking Diagrams**

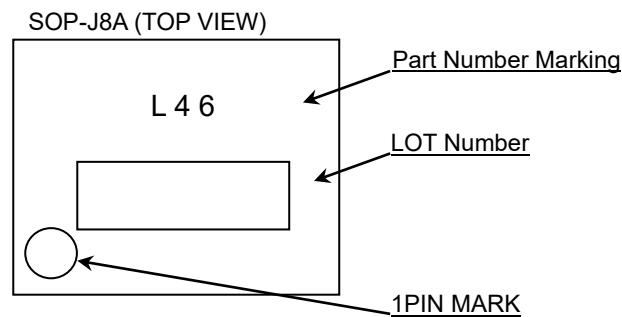

Physical Dimension and Packing Information

| | |
|--------------|---------|
| Package Name | SOP-J8A |
|--------------|---------|

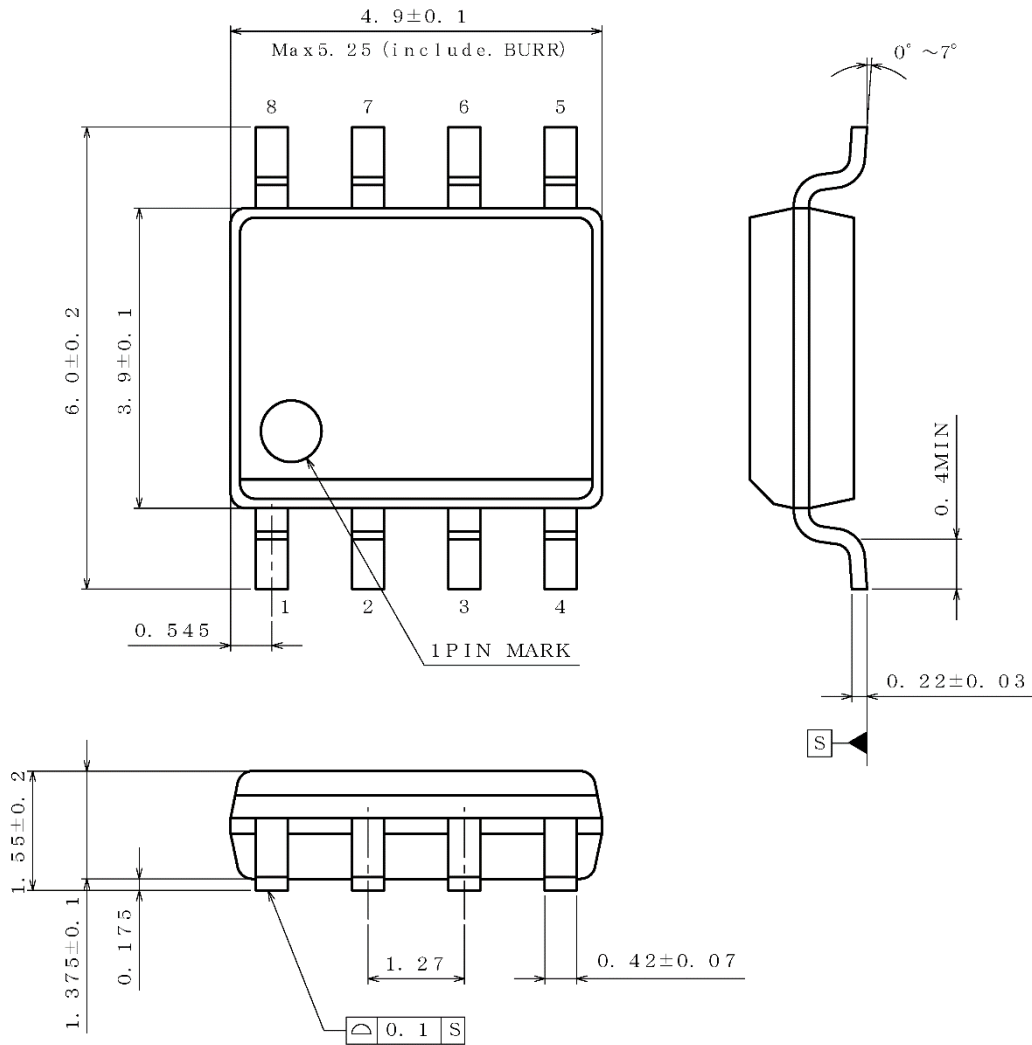

(UNIT : mm)
 PKG : SOP-J8A
 Drawing No. EX001-0055-2

< Tape and Reel Information >

| | |
|-------------------|---|
| Tape | Embossed carrier tape |
| Quantity | 2500pcs |
| Direction of feed | E2 The direction is the pin 1 of product is at the upper left when you hold reel on the left hand and you pull out the tape on the right hand |

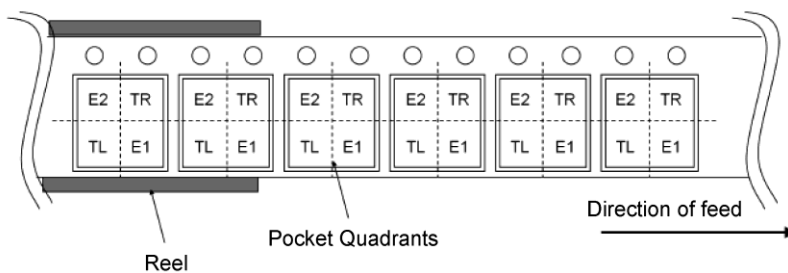

Notice

Precaution on using ROHM Products

- Our Products are designed and manufactured for application in ordinary electronic equipment (such as AV equipment, OA equipment, telecommunication equipment, home electronic appliances, amusement equipment, etc.). If you intend to use our Products in devices requiring extremely high reliability (such as medical equipment ^(Note 1), transport equipment, traffic equipment, aircraft/spacecraft, nuclear power controllers, fuel controllers, car equipment including car accessories, safety devices, etc.) and whose malfunction or failure may cause loss of human life, bodily injury or serious damage to property ("Specific Applications"), please consult with the ROHM sales representative in advance. Unless otherwise agreed in writing by ROHM in advance, ROHM shall not be in any way responsible or liable for any damages, expenses or losses incurred by you or third parties arising from the use of any ROHM's Products for Specific Applications.

(Note1) Medical Equipment Classification of the Specific Applications

| JAPAN | USA | EU | CHINA |
|-----------|-----------|------------|-----------|
| CLASS III | CLASS III | CLASS II b | CLASS III |
| CLASS IV | | CLASS III | |

- ROHM designs and manufactures its Products subject to strict quality control system. However, semiconductor products can fail or malfunction at a certain rate. Please be sure to implement, at your own responsibilities, adequate safety measures including but not limited to fail-safe design against the physical injury, damage to any property, which a failure or malfunction of our Products may cause. The following are examples of safety measures:
 - Installation of protection circuits or other protective devices to improve system safety
 - Installation of redundant circuits to reduce the impact of single or multiple circuit failure
- Our Products are designed and manufactured for use under standard conditions and not under any special or extraordinary environments or conditions, as exemplified below. Accordingly, ROHM shall not be in any way responsible or liable for any damages, expenses or losses arising from the use of any ROHM's Products under any special or extraordinary environments or conditions. If you intend to use our Products under any special or extraordinary environments or conditions (as exemplified below), your independent verification and confirmation of product performance, reliability, etc. prior to use, must be necessary:
 - Use of our Products in any types of liquid, including water, oils, chemicals, and organic solvents
 - Use of our Products outdoors or in places where the Products are exposed to direct sunlight or dust
 - Use of our Products in places where the Products are exposed to sea wind or corrosive gases, including Cl₂, H₂S, NH₃, SO₂, and NO₂
 - Use of our Products in places where the Products are exposed to static electricity or electromagnetic waves
 - Use of our Products in proximity to heat-producing components, plastic cords, or other flammable items
 - Sealing or coating our Products with resin or other coating materials
 - Use of our Products without cleaning residue of flux (Exclude cases where no-clean type fluxes is used. However, recommend sufficiently about the residue.) ; or Washing our Products by using water or water-soluble cleaning agents for cleaning residue after soldering
 - Use of the Products in places subject to dew condensation
- The Products are not subject to radiation-proof design.
- Please verify and confirm characteristics of the final or mounted products in using the Products.
- In particular, if a transient load (a large amount of load applied in a short period of time, such as pulse, is applied, confirmation of performance characteristics after on-board mounting is strongly recommended. Avoid applying power exceeding normal rated power; exceeding the power rating under steady-state loading condition may negatively affect product performance and reliability.
- De-rate Power Dissipation depending on ambient temperature. When used in sealed area, confirm that it is the use in the range that does not exceed the maximum junction temperature.
- Confirm that operation temperature is within the specified range described in the product specification.
- ROHM shall not be in any way responsible or liable for failure induced under deviant condition from what is defined in this document.

Precaution for Mounting / Circuit board design

- When a highly active halogenous (chlorine, bromine, etc.) flux is used, the residue of flux may negatively affect product performance and reliability.
- In principle, the reflow soldering method must be used on a surface-mount products, the flow soldering method must be used on a through hole mount products. If the flow soldering method is preferred on a surface-mount products, please consult with the ROHM representative in advance.

For details, please refer to ROHM Mounting specification

Precautions Regarding Application Examples and External Circuits

1. If change is made to the constant of an external circuit, please allow a sufficient margin considering variations of the characteristics of the Products and external components, including transient characteristics, as well as static characteristics.
2. You agree that application notes, reference designs, and associated data and information contained in this document are presented only as guidance for Products use. Therefore, in case you use such information, you are solely responsible for it and you must exercise your own independent verification and judgment in the use of such information contained in this document. ROHM shall not be in any way responsible or liable for any damages, expenses or losses incurred by you or third parties arising from the use of such information.

Precaution for Electrostatic

This Product is electrostatic sensitive product, which may be damaged due to electrostatic discharge. Please take proper caution in your manufacturing process and storage so that voltage exceeding the Products maximum rating will not be applied to Products. Please take special care under dry condition (e.g. Grounding of human body / equipment / solder iron, isolation from charged objects, setting of ionizer, friction prevention and temperature / humidity control).

Precaution for Storage / Transportation

1. Product performance and soldered connections may deteriorate if the Products are stored in the places where:
 - [a] the Products are exposed to sea winds or corrosive gases, including Cl₂, H₂S, NH₃, SO₂, and NO₂
 - [b] the temperature or humidity exceeds those recommended by ROHM
 - [c] the Products are exposed to direct sunshine or condensation
 - [d] the Products are exposed to high Electrostatic
2. Even under ROHM recommended storage condition, solderability of products out of recommended storage time period may be degraded. It is strongly recommended to confirm solderability before using Products of which storage time is exceeding the recommended storage time period.
3. Store / transport cartons in the correct direction, which is indicated on a carton with a symbol. Otherwise bent leads may occur due to excessive stress applied when dropping of a carton.
4. Use Products within the specified time after opening a humidity barrier bag. Baking is required before using Products of which storage time is exceeding the recommended storage time period.

Precaution for Product Label

A two-dimensional barcode printed on ROHM Products label is for ROHM's internal use only.

Precaution for Disposition

When disposing Products please dispose them properly using an authorized industry waste company.

Precaution for Foreign Exchange and Foreign Trade act

Since concerned goods might be fallen under listed items of export control prescribed by Foreign exchange and Foreign trade act, please consult with ROHM in case of export.

Precaution Regarding Intellectual Property Rights

1. All information and data including but not limited to application example contained in this document is for reference only. ROHM does not warrant that foregoing information or data will not infringe any intellectual property rights or any other rights of any third party regarding such information or data.
2. ROHM shall not have any obligations where the claims, actions or demands arising from the combination of the Products with other articles such as components, circuits, systems or external equipment (including software).
3. No license, expressly or implied, is granted hereby under any intellectual property rights or other rights of ROHM or any third parties with respect to the Products or the information contained in this document. Provided, however, that ROHM will not assert its intellectual property rights or other rights against you or your customers to the extent necessary to manufacture or sell products containing the Products, subject to the terms and conditions herein.

Other Precaution

1. This document may not be reprinted or reproduced, in whole or in part, without prior written consent of ROHM.
2. The Products may not be disassembled, converted, modified, reproduced or otherwise changed without prior written consent of ROHM.
3. In no event shall you use in any way whatsoever the Products and the related technical information contained in the Products or this document for any military purposes, including but not limited to, the development of mass-destruction weapons.
4. The proper names of companies or products described in this document are trademarks or registered trademarks of ROHM, its affiliated companies or third parties.

General Precaution

1. Before you use our Products, you are requested to carefully read this document and fully understand its contents. ROHM shall not be in any way responsible or liable for failure, malfunction or accident arising from the use of any ROHM's Products against warning, caution or note contained in this document.
2. All information contained in this document is current as of the issuing date and subject to change without any prior notice. Before purchasing or using ROHM's Products, please confirm the latest information with a ROHM sales representative.
3. The information contained in this document is provided on an "as is" basis and ROHM does not warrant that all information contained in this document is accurate and/or error-free. ROHM shall not be in any way responsible or liable for any damages, expenses or losses incurred by you or third parties resulting from inaccuracy or errors of or concerning such information.