



# MIC5283

120V<sub>IN</sub>, 150mA, Ultra-Low I<sub>Q</sub>, High-PSRR  
Linear Regulator

## General Description

The MIC5283 high-performance linear regulator offers a very-wide input operating voltage range, up to 120V DC, and supplies an output current of up to 150mA.

Ideal for high input voltage applications such as industrial and telecom, the MIC5283 offers  $\pm 3\%$  initial accuracy, extremely high-power supply rejection ratio (75dB at 10kHz) and an ultra-low quiescent current of 8 $\mu$ A. The MIC5283 is optimized for high-voltage line transients, making it ideal for harsh environment applications.

The MIC5283 is offered in both fixed output voltage (3.3V or 5.0V) and adjustable output voltage (1.22V to 5.5V) options.

The MIC5283 operates over a  $-40^{\circ}\text{C}$  to  $+125^{\circ}\text{C}$  temperature range and is available in lead-free, RoHS-compliant, ePad SOIC-8 and 3mm x 3mm MLF<sup>®</sup> packages.

Data sheet and support documentation are found on the Micrel website: [www.micrel.com](http://www.micrel.com).

## Features

- Wide input voltage range: 6V to 120V DC
- Ultra-low quiescent current: 8 $\mu$ A
- 150mA guaranteed output current
- Adjustable output from 1.22V to 5.5V
- Stable with ceramic capacitors
- Ultra-high PSRR (75dB at 10kHz)
- Ultra-high line rejection (load dump)
- High output accuracy:
  - $\pm 3\%$  initial accuracy
- Thermal-shutdown and current-limit protection
- Thermally-efficient, 8-pin ePad SOIC package
- Very low-profile 3mm x 3mm MLF<sup>®</sup> package

## Applications

- Industrial applications
- Remote keyless entry power supply
- Telecom applications
- Off-line power supplies

## Typical Applications

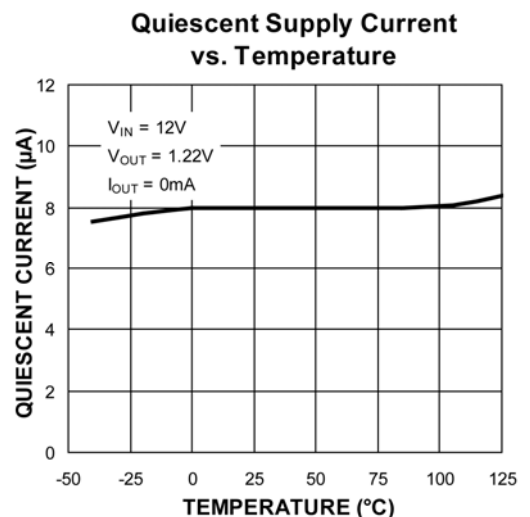
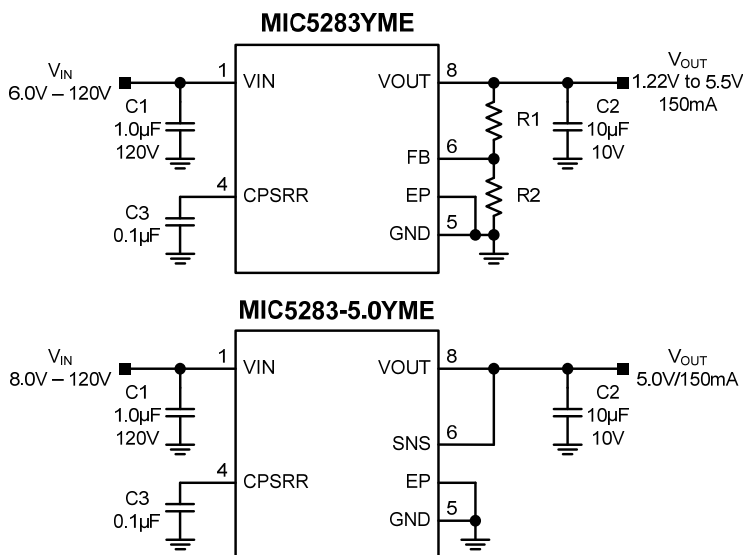

MLF and MicroLeadFrame are registered trademarks of Amkor Technology, Inc.

## Ordering Information

Part Number	Output Voltage	Top Mark	Temperature Range	Package	Lead Finish
MIC5283YME	Adjustable	5283YME	-40°C to +125°C	8-Pin ePad SOIC	Pb-Free
MIC5283-3.3YME	3.3V	5283-33YME	-40°C to +125°C	8-Pin ePad SOIC	Pb-Free
MIC5283-5.0YME	5.0V	5283-50YME	-40°C to +125°C	8-Pin ePad SOIC	Pb-Free
MIC5283YML	Adjustable	A83	-40°C to +125°C	3mmx3mm MLF <sup>®</sup> -8L	Pb-Free
MIC5283-3.3YML	3.3V	8S3	-40°C to +125°C	3mmx3mm MLF <sup>®</sup> -8L	Pb-Free
MIC5283-5.0YML	5.0V	583	-40°C to +125°C	3mmx3mm MLF <sup>®</sup> -8L	Pb-Free

## Pin Configuration

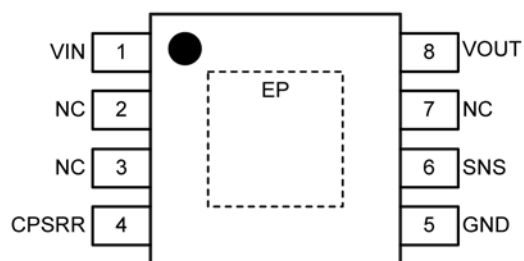

**8-Pin ePAD SOIC  
MIC5283-x.xYME  
Fixed Voltage Output**

(TOP VIEW)

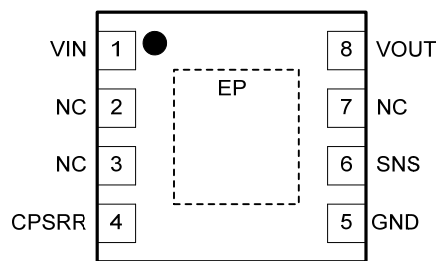

**3mm x 3mm MLF<sup>®</sup>-8L  
MIC5283-x.xYML  
Fixed Voltage Output**

(TOP VIEW)

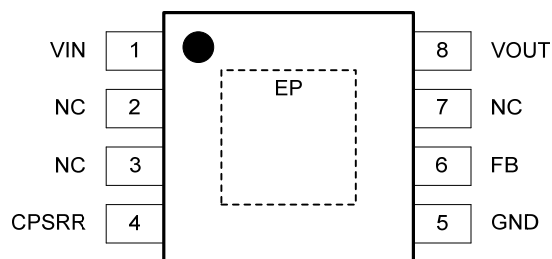

**8-Pin ePAD SOIC  
MIC5283YME  
Adjustable Voltage Output**

(TOP VIEW)

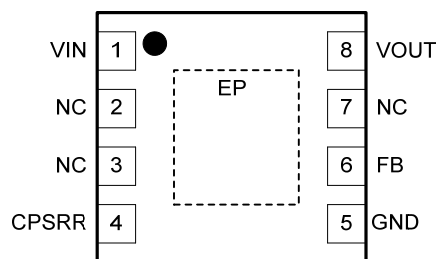

**3mm x 3mm MLF<sup>®</sup>-8L  
MIC5283YML  
Adjustable Voltage Output**

(TOP VIEW)

## Pin Description

Pin Number		Name	Function
Adjustable Output	Fixed Output		
1	1	VIN	Supply Voltage Input. Connect 1 $\mu$ F capacitor from VIN to GND.
2, 3, 7	2, 3, 7	NC	Not internally connected. Connect NC to GND or leave unconnected.
4	4	CPSRR	Bypass Capacitor Connection. Connect 0.1 $\mu$ F capacitor from CPSRR to GND.
5	5	GND	Ground.
6	—	FB	Feedback Connection. For external resistor divider to set V <sub>OUT</sub> .
—	6	SNS	Sense input. Connect SNS to V <sub>OUT</sub> .
8	8	VOUT	Regulator Output. Connect 10 $\mu$ F capacitor from V <sub>OUT</sub> to GND.
EP	EP	EP	Exposed Pad (ePad) for Thermal Dissipation. Connect EP to GND.

### Absolute Maximum Ratings<sup>(1)</sup>

V <sub>IN</sub> to GND.....	-0.3V to +125V
V <sub>CPSRR</sub> to GND.....	-0.3 to +14V
V <sub>FB</sub> , V <sub>SNS</sub> , V <sub>OUT</sub> to GND .....	-0.3V to +6V
Lead Temperature (soldering, 10s).....	+260°C
Junction Temperature .....	-40°C ≤ T <sub>J</sub> ≤ +125°C
Storage Temperature .....	-65°C ≤ T <sub>A</sub> ≤ +150°C
ESD Ratings <sup>(4)</sup>	
HBM.....	2kV
MM.....	200V

### Operating Ratings<sup>(2)</sup>

V <sub>IN</sub> .....	+6V to +120V
V <sub>OUT</sub> Adjust Range .....	+1.22V to +5.5V
Junction Temperature .....	-40°C ≤ T <sub>J</sub> ≤ +125°C
Power Dissipation (P <sub>D</sub> ).....	Internally Limited <sup>(3)</sup>
Junction Thermal Resistance (θ <sub>JA</sub> )	
8-pin ePad SOIC .....	41°C/W
3mm x 3mm MLF <sup>®</sup> -8.....	60°C/W

### Electrical Characteristics<sup>(5)</sup>

V<sub>IN</sub> = 12V, C<sub>IN</sub> = 1.0µF, C<sub>PSRR</sub> = 0.1µF, C<sub>OUT</sub> = 10µF, V<sub>OUT</sub> = 5.0V or 3.3V, I<sub>OUT</sub> = 100µA, T<sub>A</sub> = 25°C, **bold** values indicate -40°C ≤ T<sub>J</sub> ≤ +125°C, unless noted.

Parameter	Condition	Min.	Typ.	Max.	Units
<b>Power Supply Input</b>					
Input Voltage Range		6		120	V
Quiescent Supply Current	I <sub>OUT</sub> = 0		8	<b>14</b>	µA
<b>Output Voltage</b>					
Output Voltage Accuracy	Variation from nominal V <sub>OUT</sub> 100µA ≤ I <sub>OUT</sub> ≤ 150mA	-3		+3	%
		<b>-5</b>		<b>+5</b>	%
Line Regulation <sup>(6)</sup>	10V ≤ V <sub>IN</sub> ≤ 120V	<b>-0.5</b>	0.04	<b>+0.5</b>	%/V
<b>Feedback Input (Adjustable)</b>					
FB Voltage	100µA ≤ I <sub>OUT</sub> ≤ 150mA	1.183	1.220	1.256	V
		<b>1.159</b>	1.220	<b>1.281</b>	
FB Current	V <sub>FB</sub> = 1.22V		3.2		nA
<b>Current Limit</b>					
Current Limit	V <sub>OUT</sub> = 0V	<b>180</b>	300	<b>500</b>	mA
<b>Ripple Rejection</b>					
Power Supply Rejection Ratio	I <sub>OUT</sub> = 50mA	100Hz ≤ f ≤ 1kHz		70	dB
		1kHz < f ≤ 30kHz		75	dB
		30kHz < f ≤ 100kHz		65	dB
<b>Power Dropout Voltage</b>					
Dropout Voltage	I <sub>OUT</sub> = 150mA		1.8	<b>2.8</b>	V
<b>Thermal Protection</b>					
Thermal-Shutdown Temperature	T <sub>J</sub> rising		155		°C
Thermal-Shutdown Hysteresis			15		°C

**Notes:**

- Exceeding an absolute maximum rating may damage the device.
- The device is not guaranteed to function outside its operating rating.
- The maximum allowable power dissipation at any T<sub>A</sub> (ambient temperature) is P<sub>D(max)</sub> = (T<sub>J(max)</sub> - T<sub>A</sub>) / θ<sub>JA</sub>. Exceeding the maximum allowable power dissipation results in excessive die temperature, and causes the regulator to enter thermal shutdown.
- Devices are ESD sensitive; use proper handling precautions.
- Specifications are for packaged products only.
- Line regulation is a percentage of V<sub>OUT</sub>.

# Typical Characteristics

**Quiescent Supply Current vs. Input Voltage**

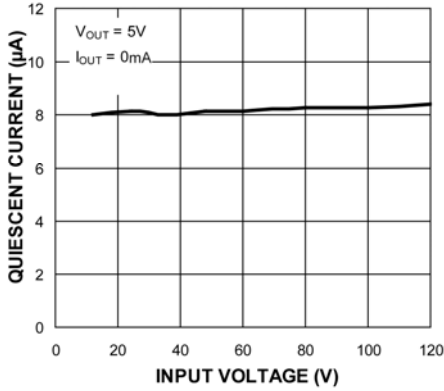

**Quiescent Supply Current vs. Temperature**

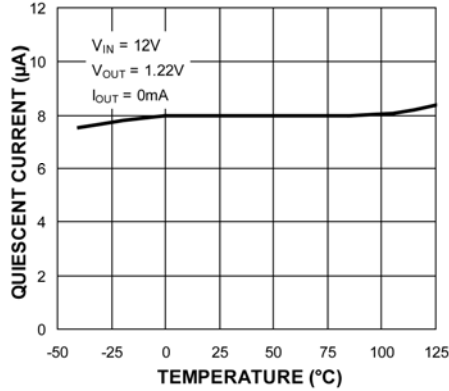

**Output Voltage vs. Input Voltage**

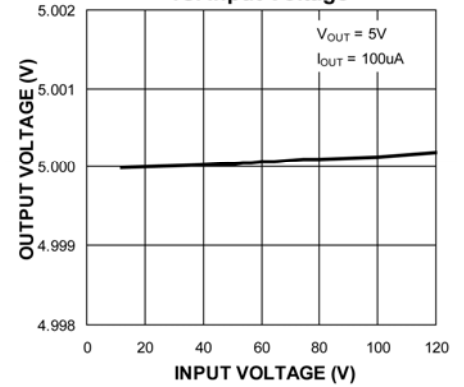

**Output Voltage vs. Output Current**

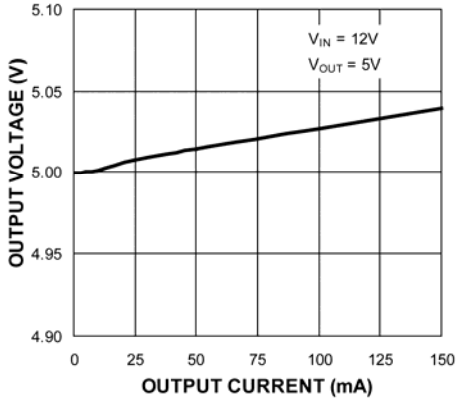

**Output Voltage vs. Temperature**

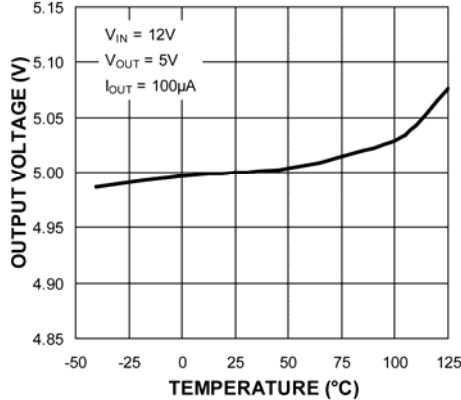

**Dropout Voltage vs. Output Current**

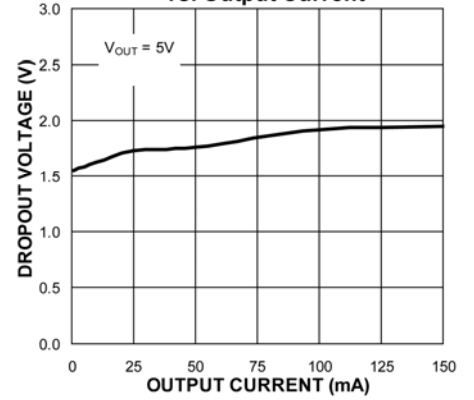

**Dropout Voltage vs. Temperature**

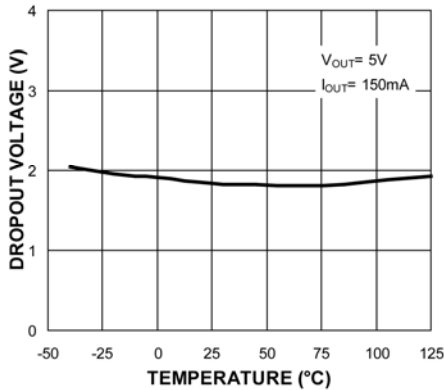

**Feedback Pin Current vs. Temperature**

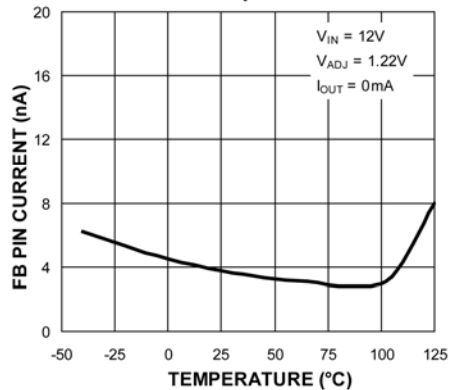

**Feedback Pin Current vs. Input Voltage**

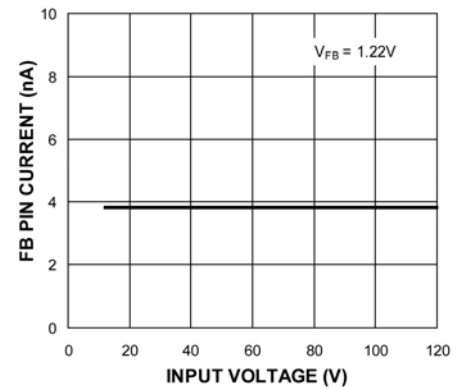

Typical Characteristics (Continued)

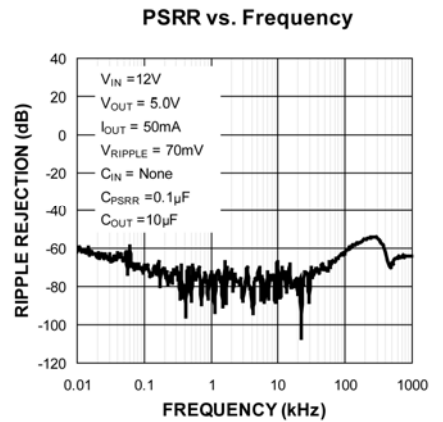
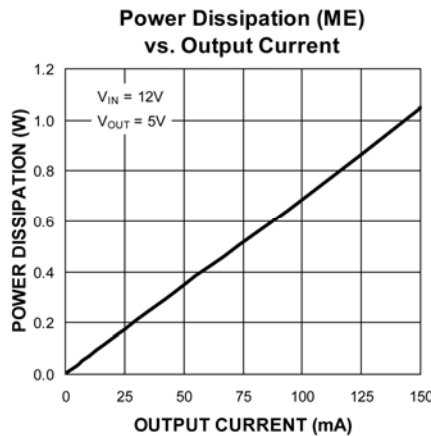
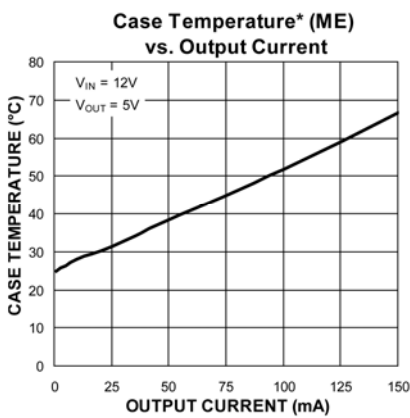
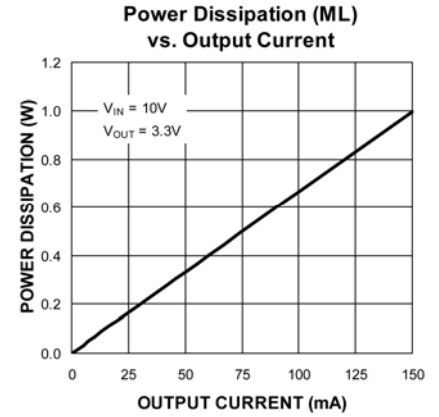
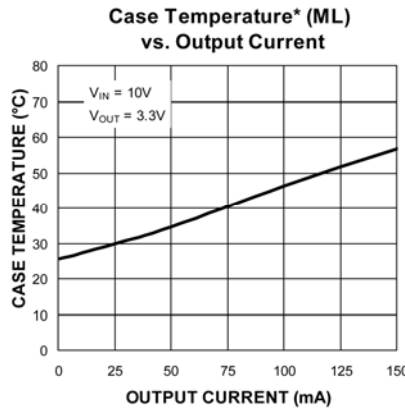
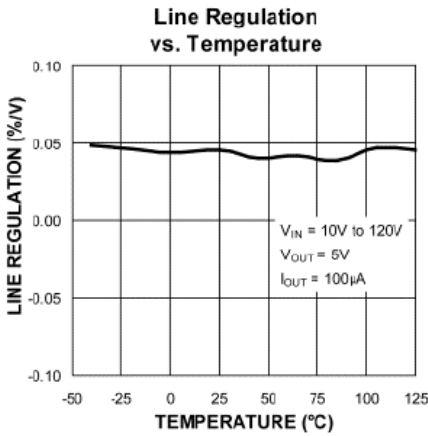
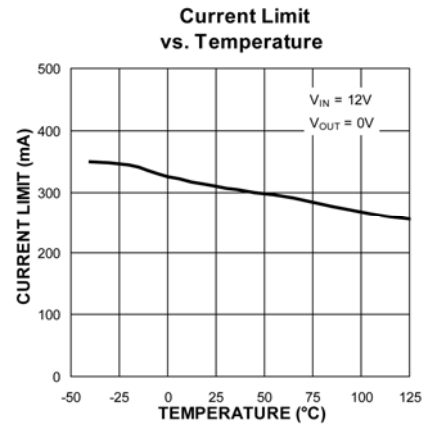
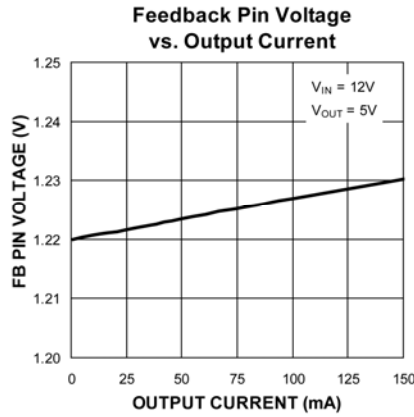
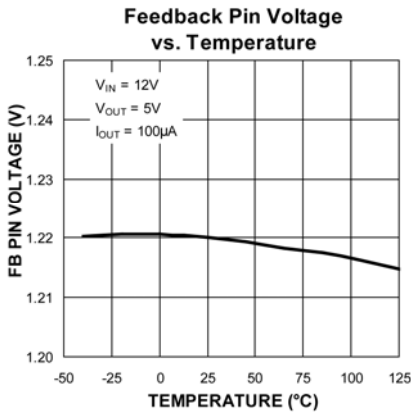

**Case Temperature\*:** The temperature measurement was taken at the hottest point on the MIC5283 case mounted on a 2.25 square inch PCB at an ambient temperature of 25°C; see “Thermal Measurement” section. Actual results will depend upon the size of the PCB, ambient temperature and proximity to other heat emitting components.

Functional Characteristics

Soft Turn-On into Full Load

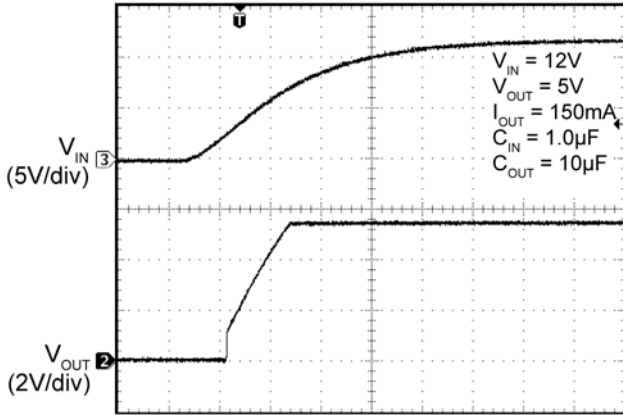

Time (2.0ms/div)

Soft Turn-Off

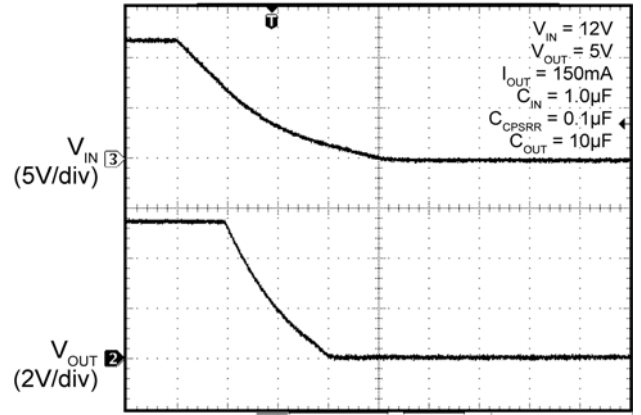

Time (10ms/div)

Fast Turn-On

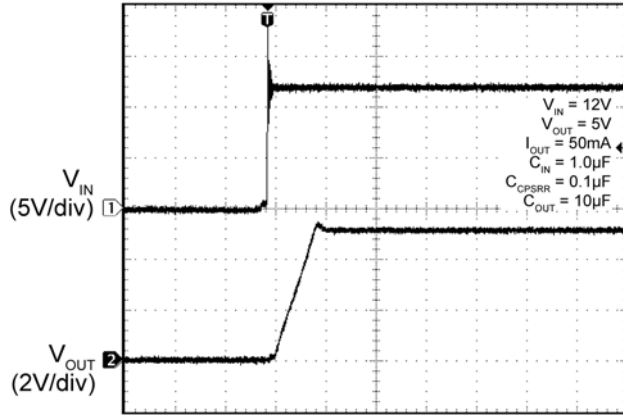

Time (200µs/div)

Fast Turn-Off

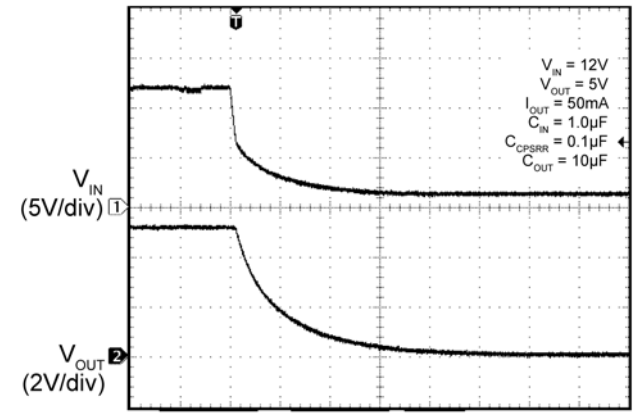

Time (1.00ms/div)

V\_IN ULVO Threshold

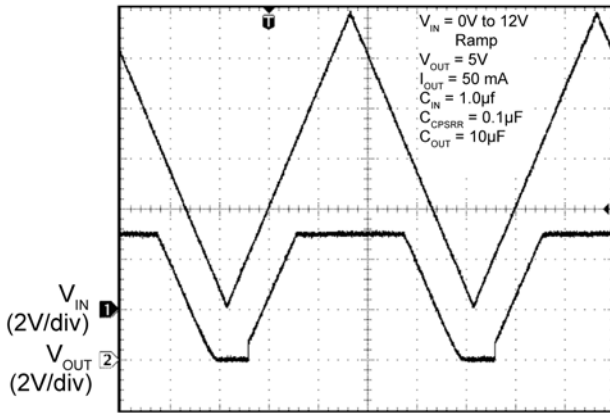

Time (200ms/div)

Current Limit

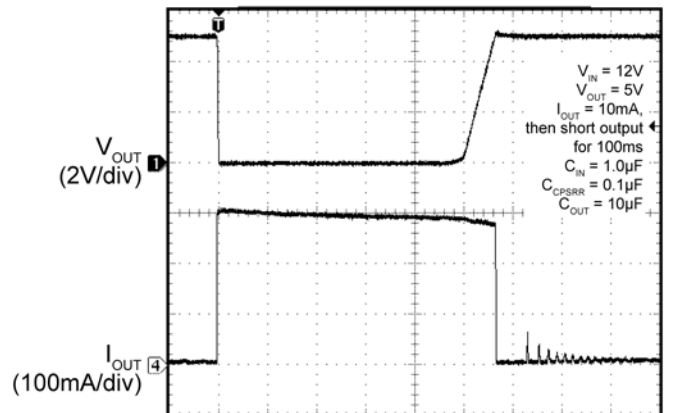

Time (20ms/div)

Functional Characteristics (Continued)

Thermal Shutdown Response

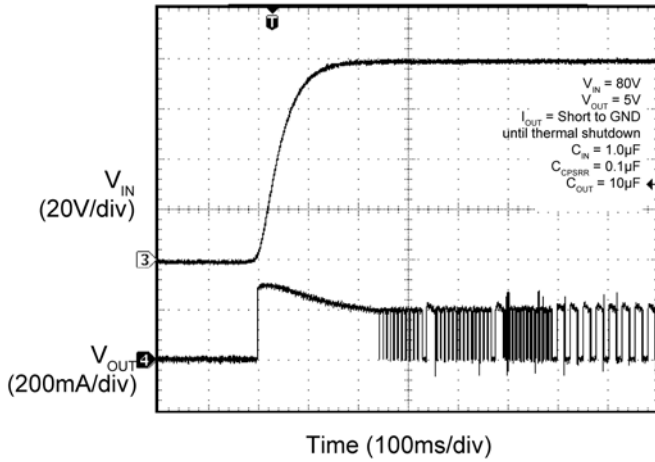

V<sub>OUT</sub> Recovery from Thermal Shutdown

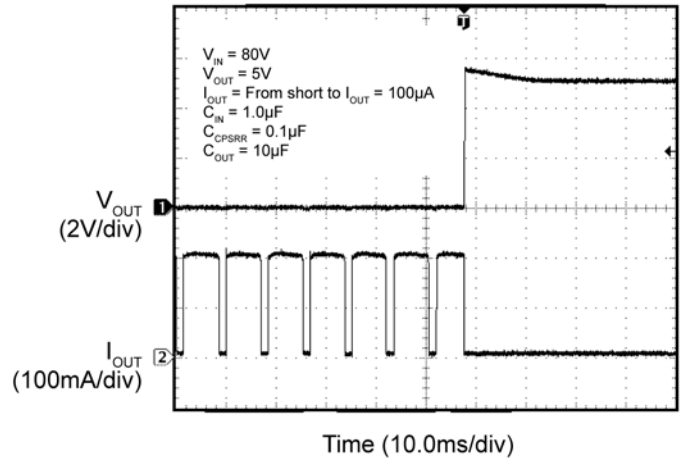

Turn-On into Short Circuit

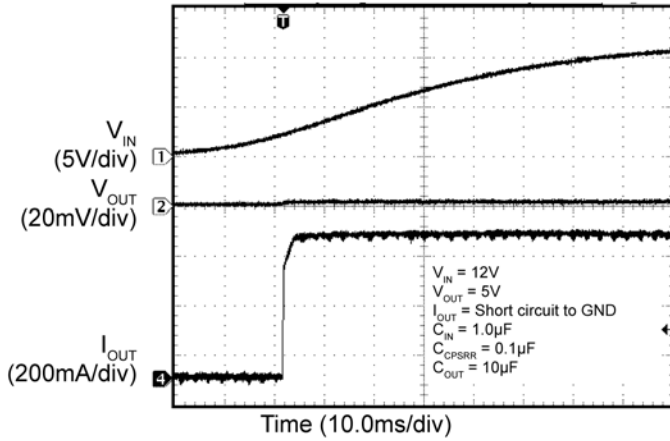

Inrush Current Response

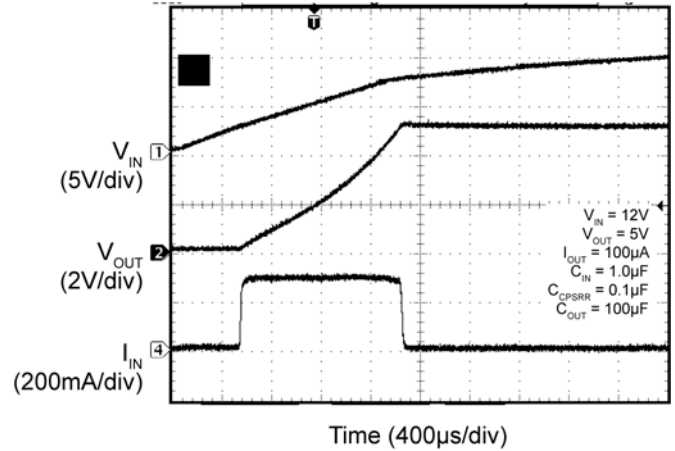

Load Transient Response

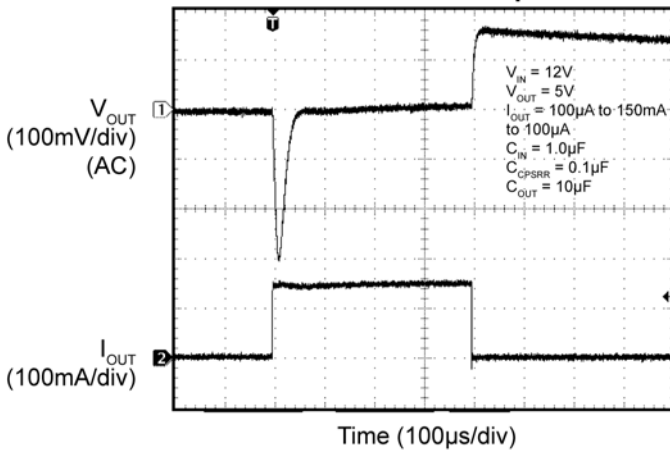

Line Transient Response

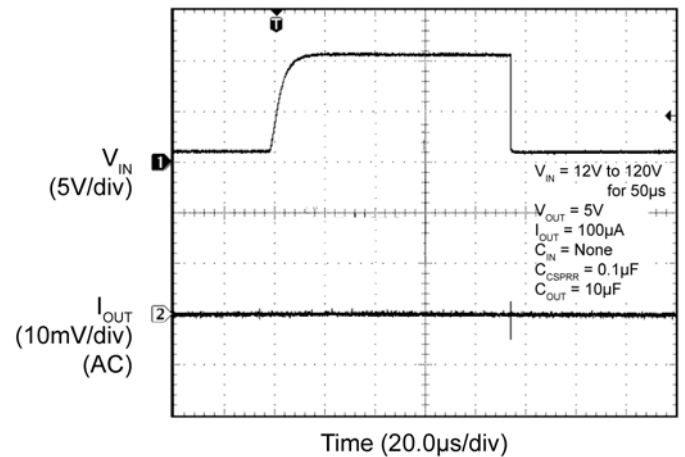



## Detailed Description

The MIC5283 voltage regulator accepts a 6V to 120V input voltage and has an ultra-low 8 $\mu$ A typical quiescent current while offering an excellent line transient response and PSRR. These features make it ideal for harsh, noisy environments. All options offer 150mA of output current. The MIC5283YML and MIC5283YME offer an adjustable output voltage from 1.22V to 5.5V. The MIC5283-3.3YML and MIC5283-3.3YME offer fixed 3.3V outputs and the MIC5283-5.0YML and MIC5283-5.0YME offer fixed 5.0V outputs. The YME packaged devices feature a heat slug to more effectively remove heat from the die.

## Applications Information

### Thermal Protection

The MIC5283 has internal thermal shutdown to protect it from excessive heating of the die. When the junction temperature exceeds approximately +155°C, the output is disabled and the device begins to cool down. The device turns back on when the junction temperature cools by 15°C. This will result in a cycled output during continuous thermal-overload conditions.

### Current Limit

The MIC5283 features output current-limit protection. The output sustains a continuous short circuit to GND without damage to the device, but thermal shutdown often results. The typical value for the current limit of the MIC5283 is 300mA.

### Input Capacitor

Connect a 1.0 $\mu$ F capacitor from VIN to GND. Micrel recommends the C5750X7R2E105M, 1.0 $\mu$ F, 250V capacitor made by TDK. When using a different capacitor, assure that the voltage rating of the capacitor has adequate headroom to withstand any potential transient.

### CPSRR Capacitor

To maintain high power supply rejection, connect a 0.1 $\mu$ F capacitor from CPSRR to GND. The voltage rating of the capacitor must be at least 14V.

### Output Capacitor

Connect a 10 $\mu$ F capacitor from VOUT to GND. Assure that the voltage rating of the capacitor exceeds the designed output voltage of the MIC5283.

### Output Voltage Setting

For the MIC5283YML and MIC5283YME, V<sub>OUT</sub> is programmable from 1.22V to 5.5V using an external resistive divider. V<sub>OUT</sub> is set using the following equation:

$$V_{OUT} = V_{REF} \times \left( \frac{R1}{R2} + 1 \right)$$

where V<sub>REF</sub> = 1.22V, and R1 and R2 form the feedback voltage divider from V<sub>OUT</sub> to ground.

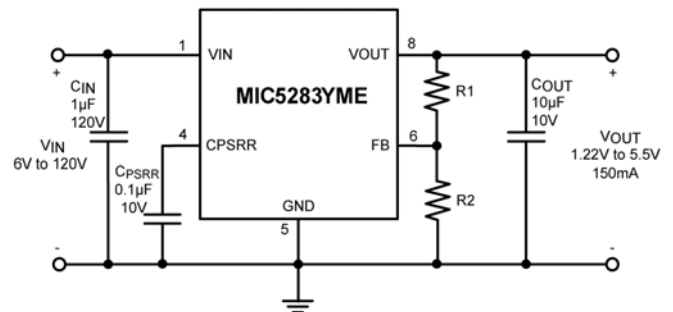

### Thermal Measurements

It is always prudent to measure an IC's case temperature to make sure that it is within operating limits, but it is easy to get erroneous results. The standard thermocouple that comes with many voltage meters uses a large wire gauge that behaves like a heat-sink, resulting in artificially low case temperature measurements. Use a thermocouple of 36-gauge wire or smaller, such as the Omega (5SC-TT-K-36-36), to minimize the heat-sinking effect. Also, apply a thermal compound to maximize heat transfer between the IC and the thermocouple.

An infrared thermometer is a recommended alternative. The IR thermometer from Optris has a 1mm spot size, ideal for monitoring small surface mount packages. Also, the optional stand makes it easy to keep the beam on the IC for long periods of time.

# Functional Diagram

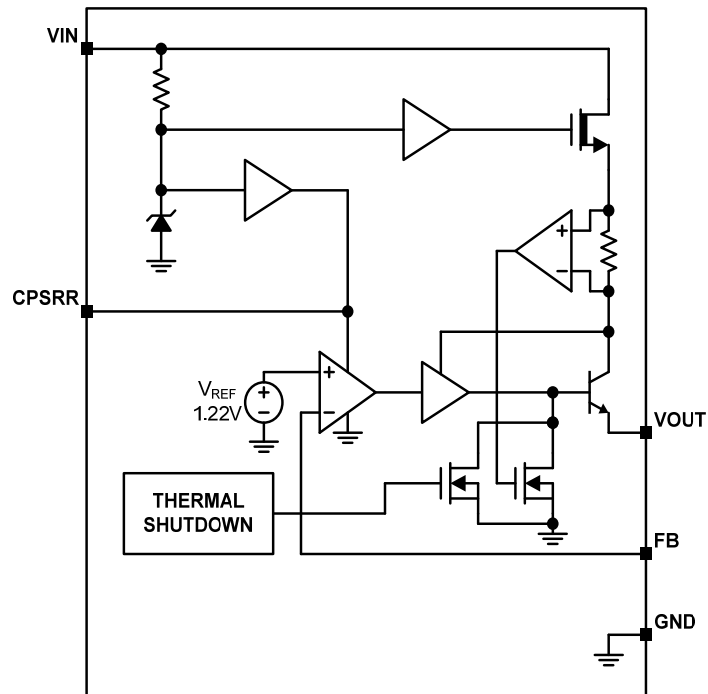

MIC5283 Adjustable Version

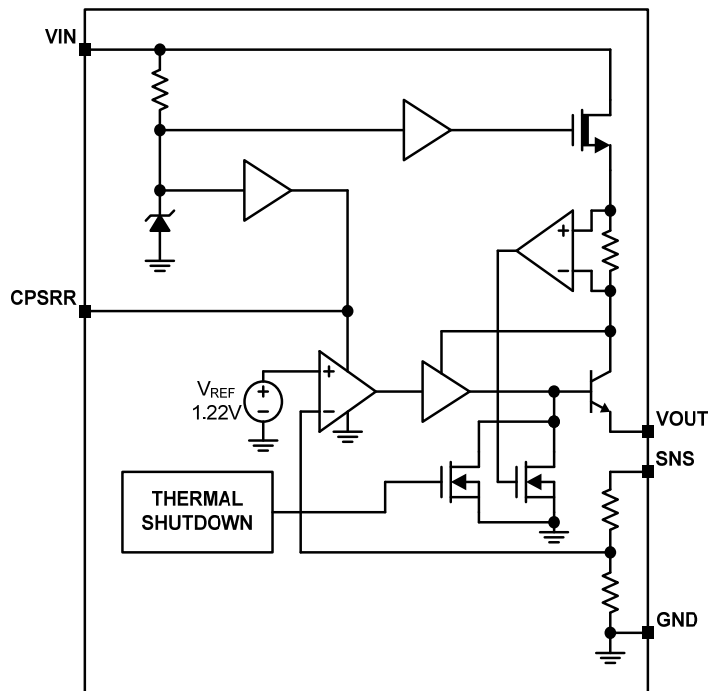

MIC5283 Fixed Version

### MIC5283 Evaluation Board Schematic

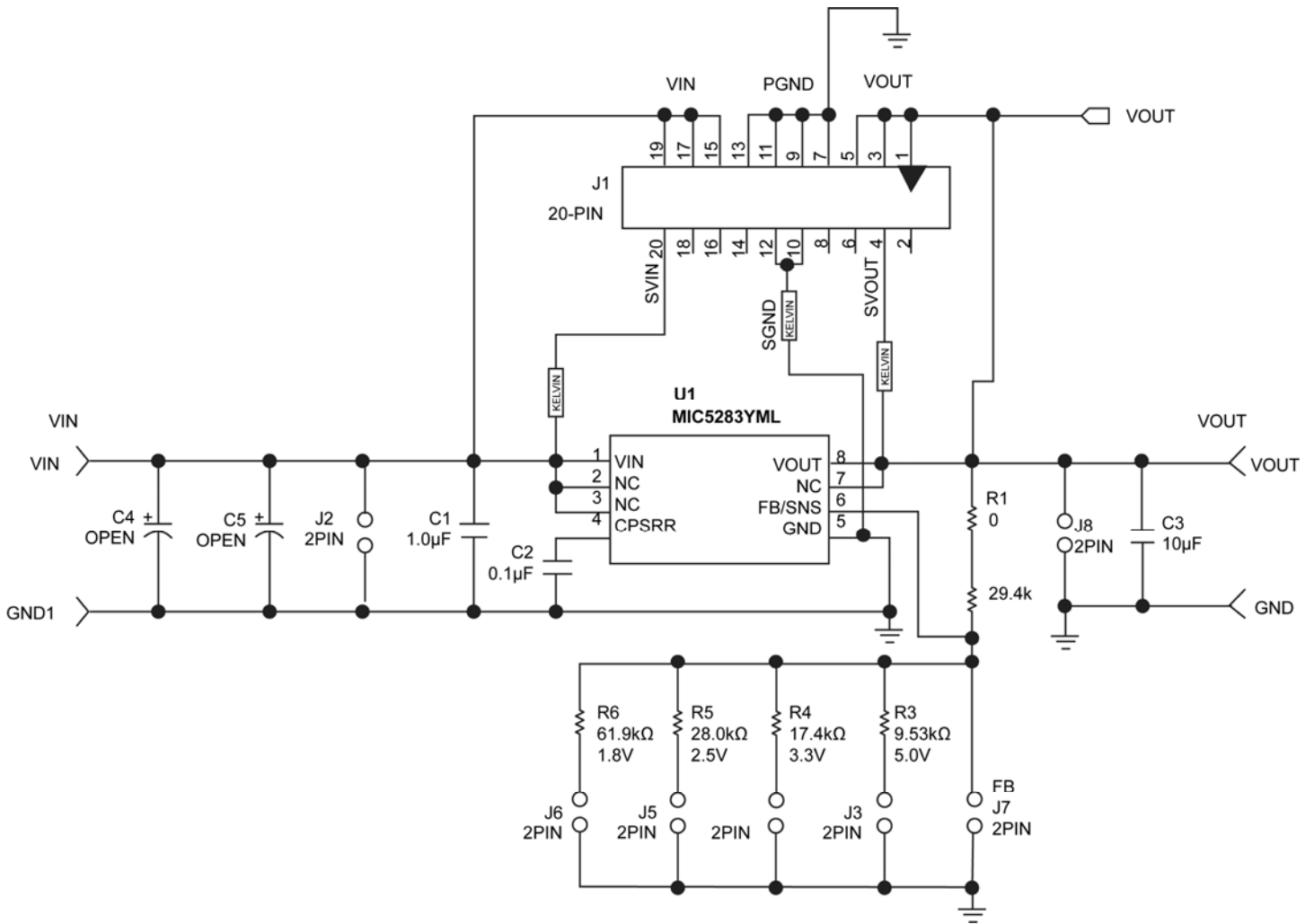

MIC5283 Evaluation Board Schematic

**Bill of Materials**

Item	Part Number	Manufacturer	Description	Qty.
C1	C5750X7R2E105M	TDK <sup>(1)</sup>	1.0μF, 250V, 20%, X7R capacitor (2220)	1
C2	08053C104KAT2A	AVX <sup>(2)</sup>	0.1μF 25V 20%, X7R capacitor (0805)	1
C3	0805ZD106KAT2A	AVX <sup>(2)</sup>	10μF, 10V, 20%, X5R, capacitor (0805)	1
R1	CRCW06030000F	Vishay/Dale <sup>(3)</sup>	0Ω, 1% resistor, 0603	1
R2	CRCW06032942F	Vishay/Dale <sup>(3)</sup>	29.4kΩ, 1% resistor, 0603	1
R3	CRCW06039531F	Vishay <sup>(3)</sup>	9.53kΩ Film Resistor, Size 0603, 1%	1
R4	CRCW06031742F	Vishay <sup>(3)</sup>	17.4kΩ Film Resistor, Size 0603, 1%	1
R5	CRCW06032802F	Vishay <sup>(3)</sup>	28.0kΩ Film Resistor, Size 0603, 1%	1
R6	CRCW06036192F	Vishay <sup>(3)</sup>	61.9kΩ Film Resistor, Size 0603, 1%	1
<b>U1</b>	<b>MIC5283YML</b>	<b>Micrel<sup>(4)</sup></b>	<b>120V<sub>IN</sub>, 150mA, Ultra-Low I<sub>Q</sub>, High-PSRR Linear Regulator</b>	<b>1</b>

**Notes:**

1. TDK: [www.tdk.com](http://www.tdk.com).
2. AVX.: [www.avx.com](http://www.avx.com).
3. Vishay Tel: [www.vishay.com](http://www.vishay.com).
4. Micrel, Inc.: [www.micrel.com](http://www.micrel.com).

# PCB Evaluation Board Layout

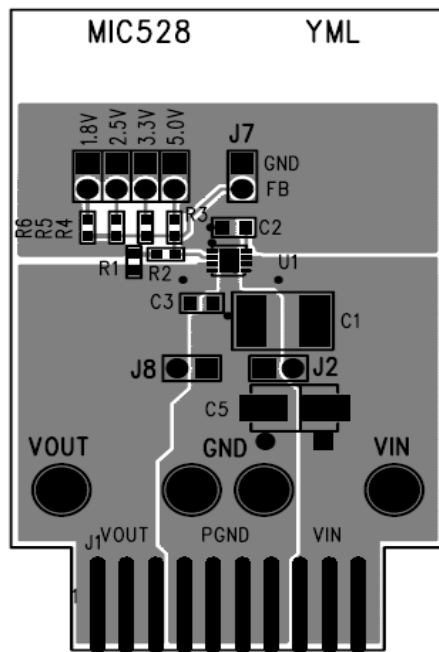

Top Layer

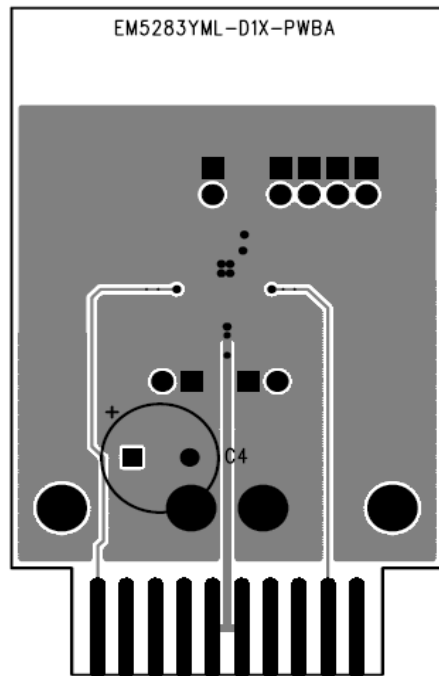

Bottom Layer

### PCB Evaluation Board Layout (Continued)

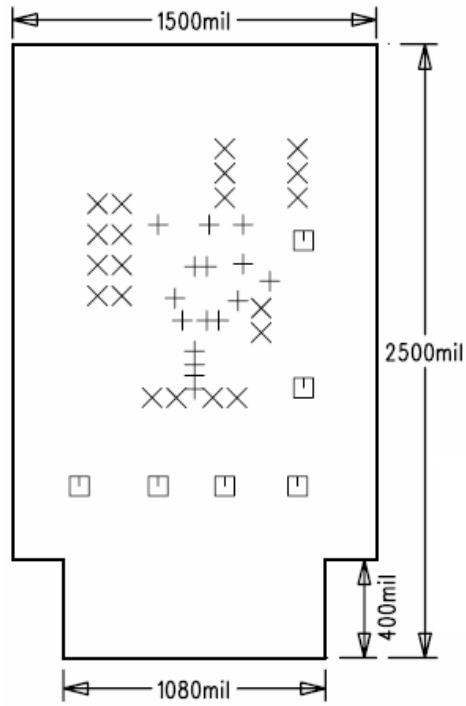

**EV Board Dimensions**

Package Information

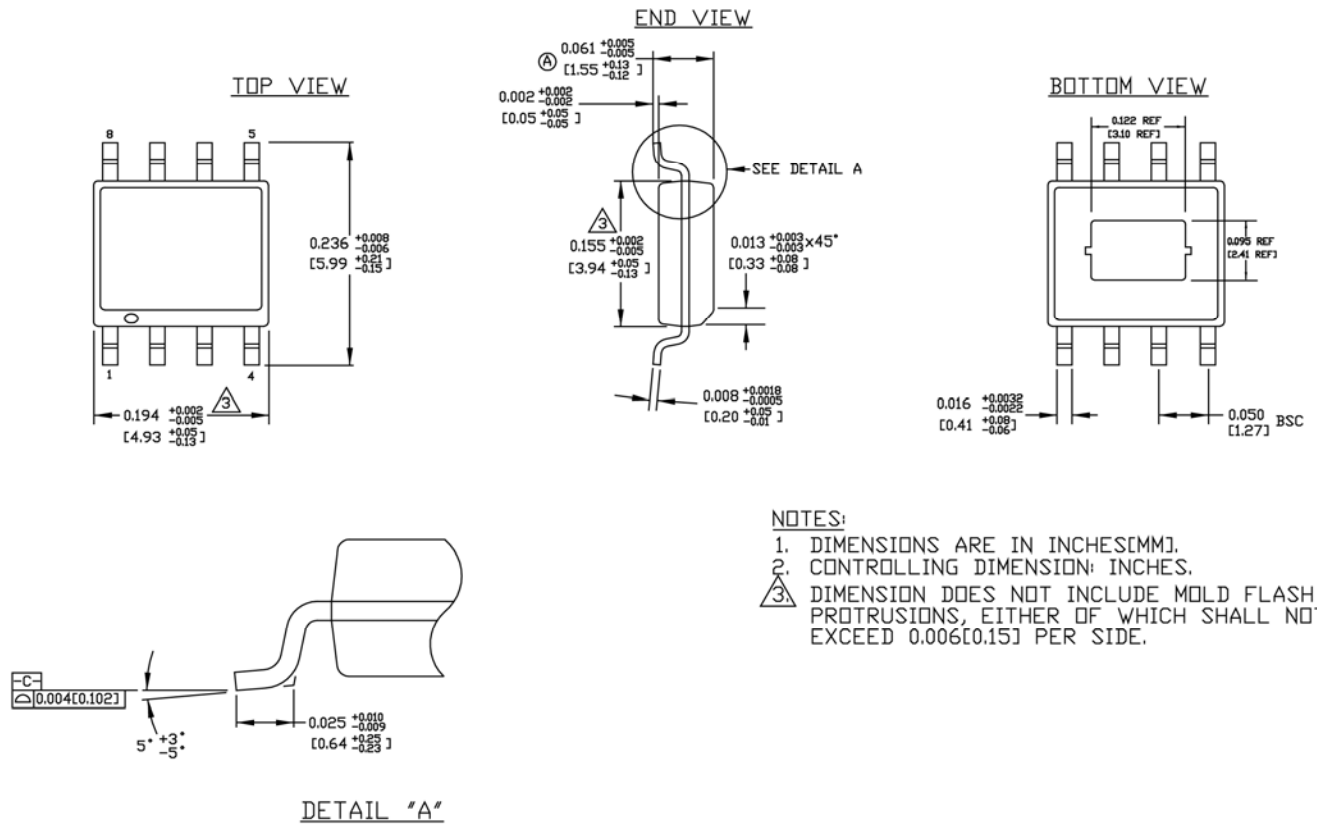

8-Pin Exposed Pad SOIC (ME)

**Package Information (Continued)**

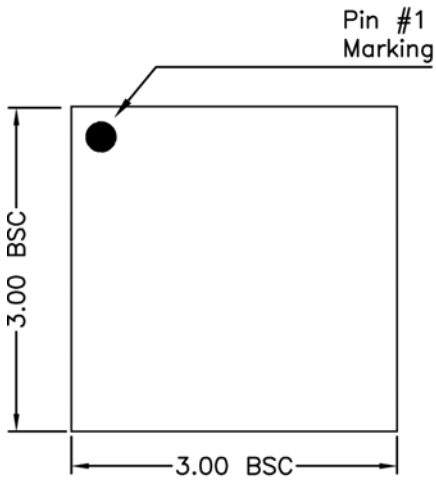

TOP VIEW

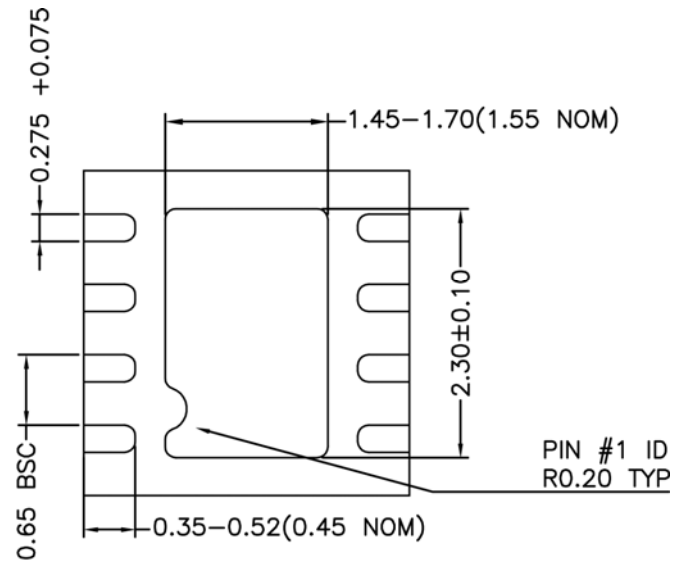

BOTTOM VIEW

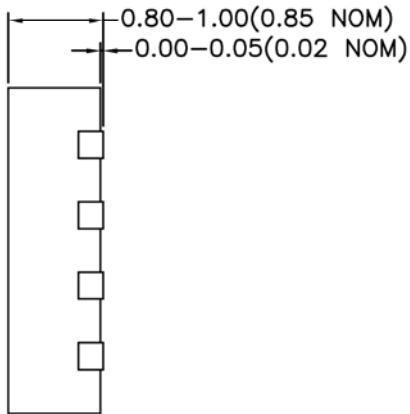

SIDE VIEW

**8-Pin 3mmx3mm MLF<sup>®</sup> (ML)**



## Recommended Land Pattern

### Recommended Land Pattern for EPAD SOIC 8 Lead

LP # SOICNEP-8LD-LP-1  
 All units are in inches  
 Tolerance  $\pm 0.05$  if not noted

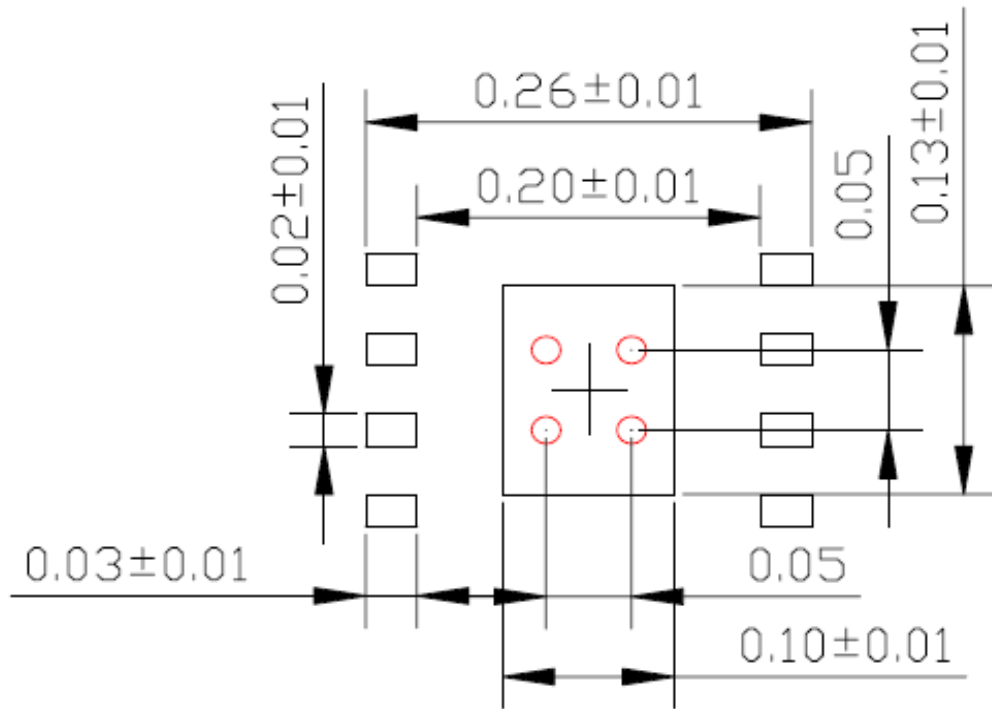

**Red circle** indicates Thermal Via. Size should be .015-.017 inches in diameter and it should be connected to GND plane for maximum thermal performance.

### 8-Pin Exposed Pad SOIC

## Recommended Land Pattern (Continued)

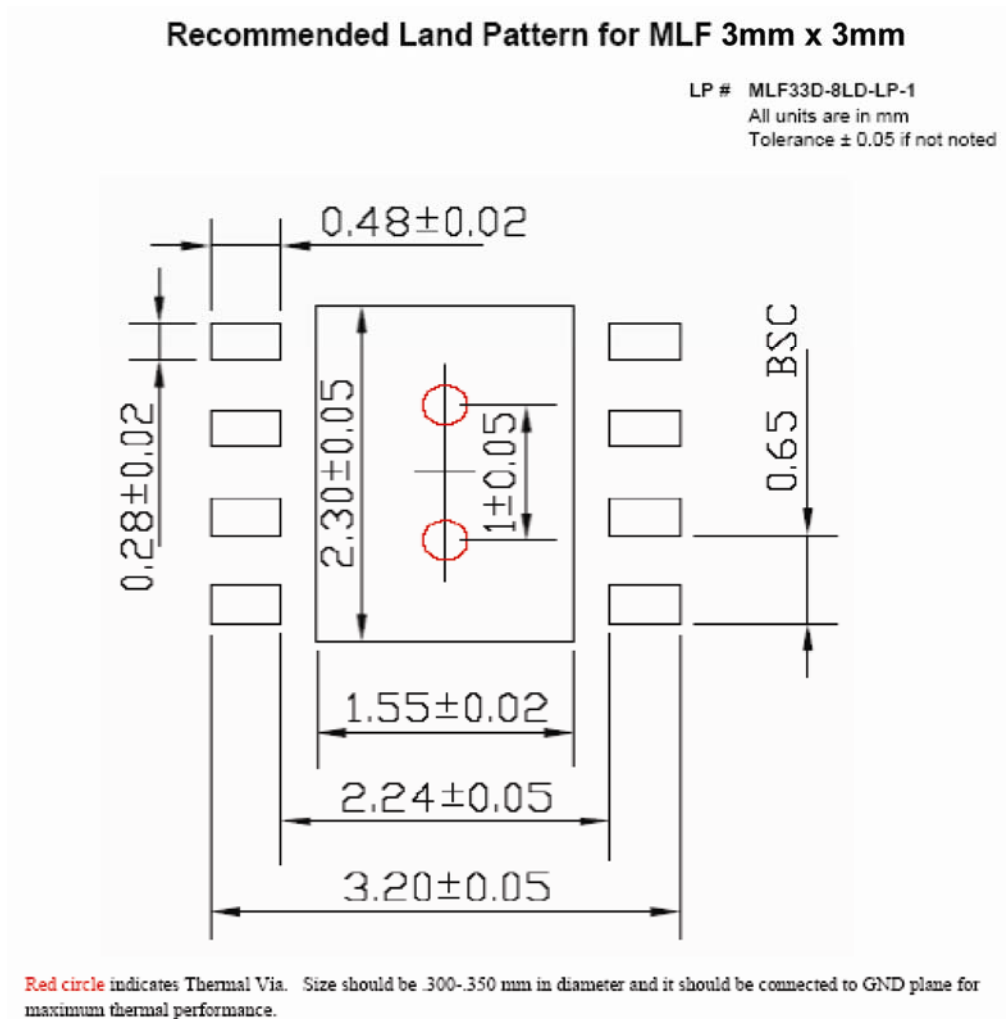

### 8-Pin 3mm x 3mm MLF<sup>®</sup>

**Red circle** indicates Thermal Via. Size should be .300mm – .350mm in diameter, 1.00mm pitch, and it should be connected to GND plane for maximum thermal performance.

---

**MICREL, INC. 2180 FORTUNE DRIVE SAN JOSE, CA 95131 USA**  
TEL +1 (408) 944-0800 FAX +1 (408) 474-1000 WEB <http://www.micrel.com>

Micrel makes no representations or warranties with respect to the accuracy or completeness of the information furnished in this data sheet. This information is not intended as a warranty and Micrel does not assume responsibility for its use. Micrel reserves the right to change circuitry, specifications and descriptions at any time without notice. No license, whether express, implied, arising by estoppel or otherwise, to any intellectual property rights is granted by this document. Except as provided in Micrel's terms and conditions of sale for such products, Micrel assumes no liability whatsoever, and Micrel disclaims any express or implied warranty relating to the sale and/or use of Micrel products including liability or warranties relating to fitness for a particular purpose, merchantability, or infringement of any patent, copyright or other intellectual property right.

Micrel Products are not designed or authorized for use as components in life support appliances, devices or systems where malfunction of a product can reasonably be expected to result in personal injury. Life support devices or systems are devices or systems that (a) are intended for surgical implant into the body or (b) support or sustain life, and whose failure to perform can be reasonably expected to result in a significant injury to the user. A Purchaser's use or sale of Micrel Products for use in life support appliances, devices or systems is a Purchaser's own risk and Purchaser agrees to fully indemnify Micrel for any damages resulting from such use or sale.

© 2012 Micrel, Incorporated.