

## DESCRIPTION

Demonstration Circuit 515 is a single output CCFL inverter with dimming and over-voltage protection features. The inverter consists of a LT1373 and a Royer converter that uses bipolar transistors. The featured LT1373 limits its switch current to 1.5A, which protects against CCFL short circuit conditions. The Royer topology is very flexible in that it operates over wide supply ranges, and it scales well over a broad output power range while keeping component count low. DC515 is most suitable for 2W–6W CCFL applications such as point-of-sale terminals and automotive LCD displays.

DC515 is designed to operate for a  $V_{IN}$  range of 5V–20V and outputs hundreds of volts at mA current levels.

Dimming can be achieved by either an analog signal or a PWM signal applied to the Vprog terminal, or by adjusting a potentiometer. The over-voltage protection feature (when enabled) protects the Royer transformer from excessive high voltages when the CCFL is not connected to the output.

**Design files for this circuit board are available. Call the LTC factory.**

## QUICK START PROCEDURE

DC515 is easy to set up to evaluate the performance of the LT1373. Refer to Figure 1 for proper measurement equipment setup and follow the procedure below:

1. Connect the LCD\CCFL across the CCFL – and + terminals E5 and E6. Connect the positive CCFL wire to E5 and the negative terminal of the CCFL to E6.

**Warning:** There may be *thousands of volts* across the CCFL – and + terminals, across the capacitor C1, and on the secondary side of the transformer T1. *These high voltages can be very harmful to anyone who touches these points.*

2. Ground the LCD Casing.
3. Apply 8V–20V to the Vin and Gnd terminals.

**NOTE:** 5V–8V input may be too low a voltage for some LCDs\CCFLs that have unusual characteristics. If one such LCD is being used contact the LTC Applications Department for directions on how the board can be modified to operate down to 5V.

4. Carefully adjust R2 until the CCFL current equals the maximum current for which the CCFL is specified.
5. Apply the system  $V_{PROG}$  supply to the Vprog terminal. Set the  $V_{PROG}$  voltage to its specified maximum (5V is the limit). Adjust R8 until zero current flows in the CCFL. CCFL current can now be adjusted over its full range by adjusting  $V_{PROG}$  over its full range.

# QUICK START GUIDE FOR DEMONSTRATION CIRCUIT 515

## CCFL POWER SUPPLY

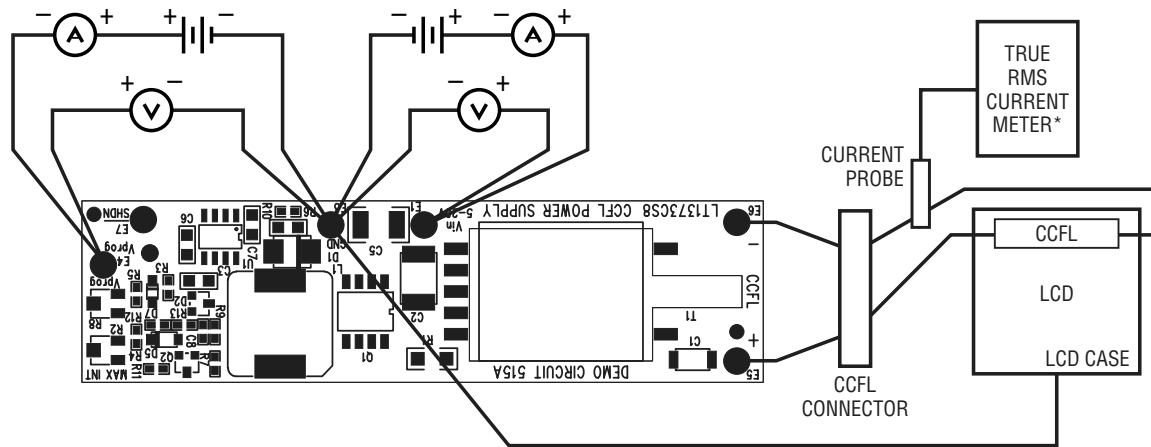

\* FOR A DESCRIPTION OF HOW TO ACCURATELY MEASURE CCFL CURRENT, SEE LINEAR TECHNOLOGY APPLICATION NOTE 65 (AN65), APPENDIX C

**Figure 1. Proper Measurement Equipment Setup**

# QUICK START GUIDE FOR DEMONSTRATION CIRCUIT 515

## CCFL POWER SUPPLY

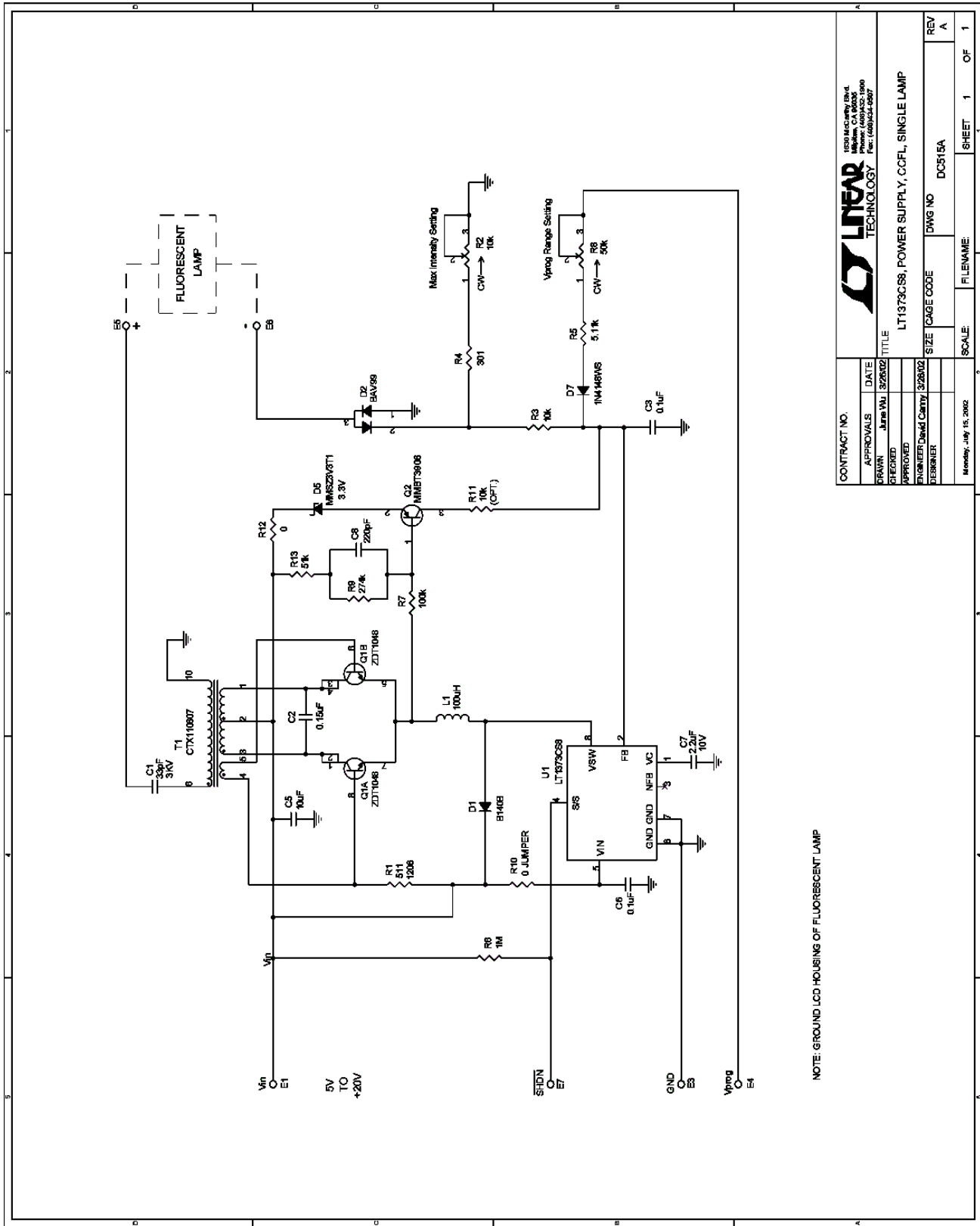

CONTRACT NO.		DATE	
APPROVALS	DATE	APPROVALS	DATE
DRAWN	3/26/02	CHECKED	
ENGINEER	David Canty	DESIGNED	
TITLE			
LT1373CS8, POWER SUPPLY, CCFL, SINGLE LAMP			
SIZE		CAGE CODE	
DWG NO		DC0515A	
SCALE		FILENAME	
SHEET 1		OF 1	

LINEAR TECHNOLOGY		10000 Cavendish Dr.,	
		Folsom, CA 95632-1900	
		Phone: (916) 352-1900	
		Fax: (916) 352-0807	
Monday, July 15, 2002			



# QUICK START GUIDE FOR DEMONSTRATION CIRCUIT 515

## CCFL POWER SUPPLY

---

### APPROVED VENDOR LIST

VENDOR	PHONE NUMBER	PART TYPE	WEBSITE ADDRESS
AAC (was TAD)	(800) 508-1521	CHIP RESISTORS	
AAC (was TAD)	(714) 255-9186		
AAVID	(714) 556-2665	HEAT SINKS	
ALLEN BRADLEY	(800) 592-4888	CARBON RESISTORS	
AMP	(717) 564-0100	PC MOUNT BNC	
APEM	(718) 246-1007	SMD TOGGLE/PB SWITCH	
API DELEVAN	(716) 652-3600	INDUCTORS	
AVX	(843) 946-0362	CHIP CAPS	
AVX	(843) 946-0524	CHIP RESISTORS	
AVX	(207) 282-5111	TANTALUM CAPS	
AVX	(843) 946-0323	HIGH VOLTAGE CAPS	
BERG	(800) 237-2374	CONNECTORS	
BH ELECTRONICS	(952) 894-9590	INDUCTORS	
BI TECHNOLOGIES	(714) 447-2656	TRANSFORMERS	
BI TECHNOLOGIES	(714) 447-2345	RES./RES. NETWORKS	
BOURNS	(801) 750-7253	POTENTIOMETERS, SIPS	
CADDOCK ELECTRONICS	(541) 496-0700	HIPO. RES., SIPS, DIPS	
CENTRAL SEMI	(631) 435-1110	SMALL SIGNAL DISCRETES	
CHICAGO MINIAT. LAMP	(201) 489-8989	LEDS	
COILCRAFT	(847) 639-6400	INDUCTORS	
COMM CON	(626) 301-4200	HEADERS, SHUNTS	
CONNEX	(805) 378-6464	BNC CONNECTORS	
COOPER ELECT. TECH.	(561) 752-5000	INDUCTORS	
CORNELL DUBILIER	(508) 996-8561	CAPACITORS	
CTS	(219) 293-7511	RESISTOR ARRAYS	
CUI-STACK	(503) 643-4899	POWER CONNECTORS	
DALE (see Vishay)	(605) 665-1627	INDUCTORS	
DALE (see Vishay)	(605) 665-9301	SENSE RESISTORS	
DATA DISPLAY PRODUCT	(800) 421-6815	LEDS	
DIODES INC.	(805) 446-4800	DIODES	
ELECTRONIC CONCEPTS	(908) 542-7880	400V FILM CAPACITORS	
EPSON	(310) 787-6300	CRYSTALS	
FAIRCHILD	(207) 775-4502	LOGIC	
FAIRCHILD	(408) 822-2126	MOSFETS	
FAIRCHILD	(888) 522-5372	CRG (CUST. RESPONSE)	
FCI	(717) 767-8005	HOT PLUG CONNECTORS	
FUKUSHIMA	(818) 765-8300	MPC RESISTORS	
FUJI	(201) 712-0555	SCHOTTKY DIODES	
GENERAL SEMICONDUCTOR	(516) 847-3000	DIODES	
GOWANDA	(716) 532-2234	INDUCTORS	
GRAYHILL	(708) 354-1040	DIP SWITCHES	
HARRIS	(800) 442-7747	LOGIC	
HEWLETT PACKARD	(800) 235-0312	IR LED	

# QUICK START GUIDE FOR DEMONSTRATION CIRCUIT 515

## CCFL POWER SUPPLY

---

HITACHI	(408) 433-1990	RF POWER AMPS
IDT	(408) 727-6116	LOGIC IC
IR	(310) 322-3331	MOSFETS
IRC	(361) 992-7900	SENSE RESISTORS
ITW PAKTRON	(708) 667-3444	CAPACITORS
JOHNSON COMPONENTS	(650) 948-6533	RF CONNECTORS
JOHNSON COMPONENTS	(760) 434-5961	RF CONNECTORS
KEMET	(408) 986-0424	TANTALUM CAPS
KEMET	(864) 963-6300	CRG (CUST. RESPONSE)
KETEMA	(714) 630-0081	SURGE SUPPRESSORS
KEYSTONE	(718) 956-8900	JACKS, TURRETS
LITEON	(408) 241-4588	LEDS, DIODES
LTC	(408) 432-1900	HIGH PERF. I.C.S
MAGNETICS	(800) 245-3984	TOROID CORES ETC.
MARCON	(847) 696-2000	HIGH C/V CAPACITORS
METHODE	(800) 323-6864	ZIF SOCKETS
MF ELECTRONICS	(914) 576-6570	CRYSTAL OSCILLATORS
MICROCHIP	(602) 786-7200	MICROCONTROLLER IC
MICRO PLASTICS	(870) 453-8861	NYLON STANDOFFS
MICRO-SEMI	(617) 926-0404	DIODES
MIDCOM	(605) 886-4385	INDUCTORS
MIDCOM	(800) 643-2661	INDUCTORS
MILL-MAX	(516) 922-6000	TURRETS
MINICIRCUITS	(718) 934-4500	RF TRANSFORMERS
MOTOROLA	(800) 441-2447	LOGIC, REGS
MURATA ELECTRONICS	(770) 436-1300	CAPS., INDUCTORS,
MURATA ELECTRONICS	(800) 831-9172	CRG (CUST. RESPONSE)
MURATA ELECTRONICS	(770) 433-5789	RF DEVICES
NEC/TOKIN	(510) 324-4110	INDUCTORS/HI C/V CAPS
NICHIA	(408) 573-0933	WHITE LEDS
NICHICON	(847) 843-7500	ELECTROLYTIC CAPACITOR
ON SEMICONDUCTOR	(602) 244-6600	DISCRETE DIODES ETC.
ON SHORE	(602) 921-3000	TERMINATORS
PANASONIC	(714) 373-7334	INDUCTORS, POLY CAPS
PANASONIC	(201) 348-5217	LEDS
PANASONIC	(201) 373-7334	SWITCHES
PERICOM	(408) 435-0800	LOGIC IC
PHILIPS	(914) 246-2811	INDUCTORS
PHILIPS	(914) 247-2036	PLANAR INDUCTORS
PHILIPS	(508) 851-2200	DISCRETES, I.C.s
PULSE	(619) 674-8100	INDUCTORS
QT OPTOELECTRONICS	(408) 720-1440	RF SWITCH
RAYCHEM	(800) 227-4856	FUSES
RG ALLEN	(818) 765-8300	METAL OXIDE RESISTORS
RF MICRO DEVICES	(336) 664-1233	RF2138 / RF2140
SAMTEC	(800) 726-8329	WIRE JUMPERS

# QUICK START GUIDE FOR DEMONSTRATION CIRCUIT 515

## CCFL POWER SUPPLY

---

SANYO	(619) 661-6835	OSCON CAPS
SCHOTT	(507) 532-3201	INDUCTORS, XFORMERS
SCHURTER	(707) 778-6311	FUSES AND HOLDERS
SIGNATRON	(909) 464-1883	DB9 CONNECTORS
SIEMENS	(108) 257-7910	OPTO
SILICONIX	(800) 554-5565	MOSFETS
SILICONIX	(408) 988-8000	MOSFETS
SPRAGUE	(207) 324-4140	CAPACITORS
SULLINS	(760) 744-0125	HEADERS, SHUNTS
SUMIDA	(847) 956-0667	INDUCTORS
SUMIDA	(408) 982-9660	INDUCTORS
TAIYO YUDEN	(408) 573-4150	CHIP CAPS / RES.
TAIYO YUDEN	(800) 348-2496	CRG (CUST. RESPONSE)
TEKTRONIX	(800) 835-9433	SCOPE PROBE SOCKETS
TEMIC	(408) 970-5700	IR PHOTO DIODE
THERMALLOY	(972) 243-4321	HEAT SINKS
THIN FILM TECHNOLOGY	(507) 625-8445	THIN FILM CHIP RESISTORS
TOCOS	(847) 884-6664	SMD POTENTIOMETERS
TOKIN (NEC)	(510) 324-4110	CAPS., INDUCTORS,
TOKO	(847) 699-3430	RF PRODUCTS
TOSHIBA	(714) 455-2000	SINGLE GATE LOGIC
TOSHIBA	(949) 455-2000	LOGIC
UNITED CHEMICON	(847) 696-2000	ELECTROLYTIC CAPACITOR
VISHAY	(605) 665-9301	ZENER/SM. SIGNAL DIODES
VISHAY	(605) 665-9301	INDUCTORS, SENSE Rs
VITRAMON	(203) 268-6261	CERAMIC CHIP CAPACITOR
WIMA	(914) 347-2474	PAPER/FILM CAPACITORS
ZETEX	(631) 366-5068	SMALL SIGNAL DISCRETES
ZIERICK	(800) 882-8020	STAKED PINS





# QUICK START GUIDE FOR DEMONSTRATION CIRCUIT 515

## CCFL POWER SUPPLY

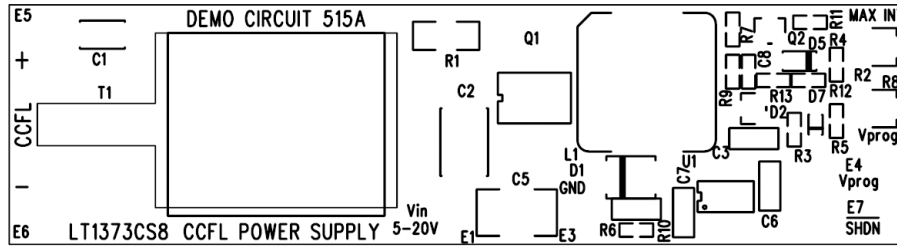

Silkscreen Top

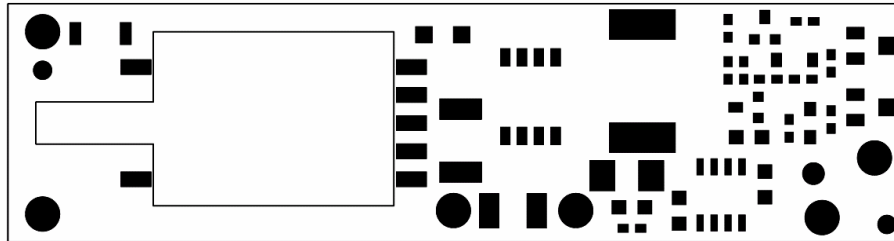

Solder Mask top

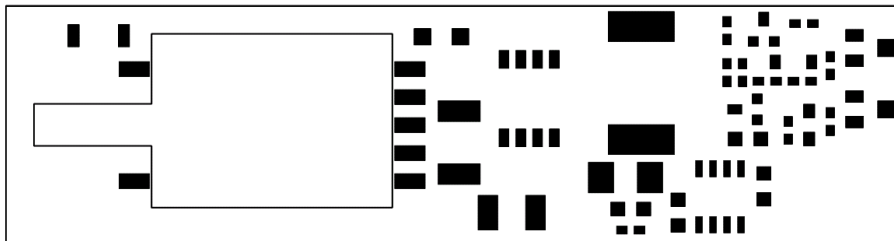

Paste Mask Top

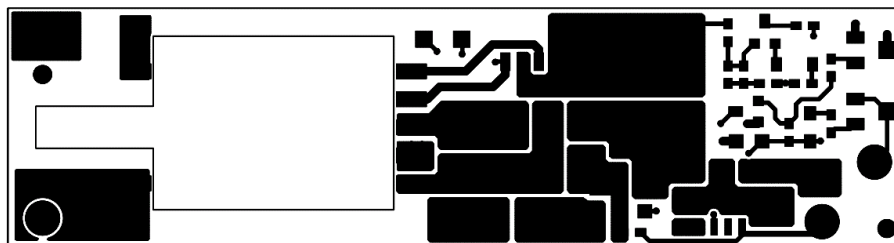

Component Side

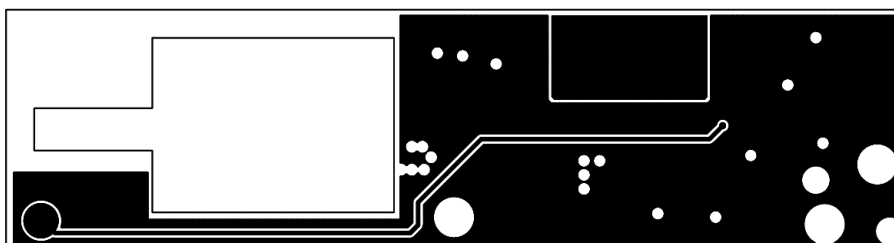

L2

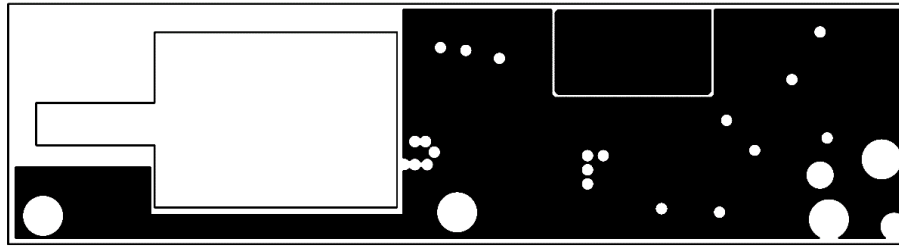

L3

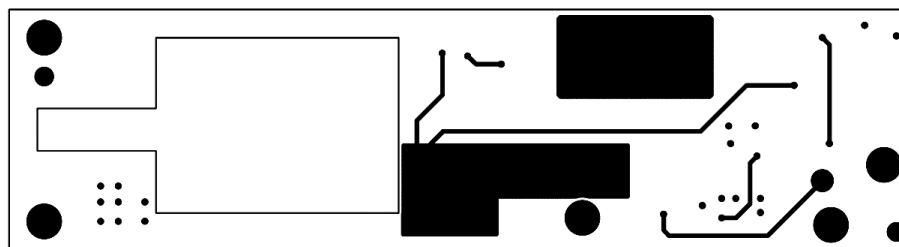

Solder Side

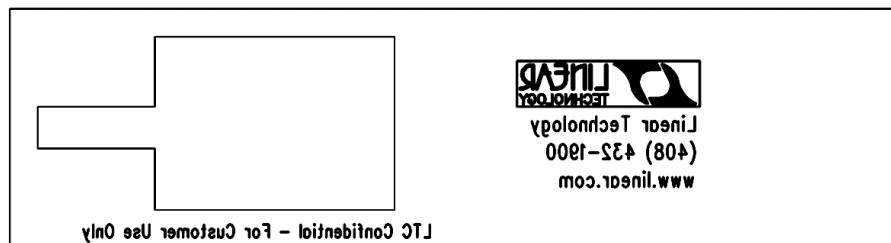

Silkscreen bottom