

Micropower, Regulated 3.3V/5V Charge Pump with Shutdown in SOT-23

FEATURES

- **Ultralow Power:** $I_{IN} = 13\mu A$
- **Regulated Output Voltage:** $3.3V \pm 4\%$, $5V \pm 4\%$
- **5V Output Current:** 50mA ($V_{IN} \geq 3.0V$)
- **3.3V Output Current:** 40mA ($V_{IN} \geq 2.5V$)
- **No Inductors Needed**
- Very Low Shutdown Current: $< 1\mu A$
- Shutdown Disconnects Load from V_{IN}
- Internal Oscillator: 600kHz
- Short-Circuit and Overtemperature Protected
- **Ultrasmall Application Circuit:** (0.052 Inch²)
- 6-Pin SOT-23 Package

APPLICATIONS

- SIM Interface Supplies for GSM Cellular Telephones
- White LED Power Supplies
- Li-Ion Battery Backup Supplies
- Handheld Computers
- Smart Card Readers
- PCMCIA Local 5V Supplies

DESCRIPTION

The LTC[®]1754 is a micropower charge pump DC/DC converter that produces a regulated output. The input voltage range is 2V to 4.4V for 3.3V output and 2.7V to 5.5V for 5V output. Extremely low operating current and a low external parts count (one flying capacitor and two small bypass capacitors at V_{IN} and V_{OUT}) make the LTC1754 ideally suited for small, battery-powered applications. The total component area of the application circuit shown below is only 0.052 inch².

The LTC1754 operates as a Burst Mode[™] switched capacitor voltage doubler to produce a regulated output. It has thermal shutdown capability and can survive a continuous short circuit from V_{OUT} to GND.

The LTC1754 is available in a 6-pin SOT-23 package.

LT, LTC and LT are registered trademarks of Linear Technology Corporation.
Burst Mode is a trademark of Linear Technology Corporation.

TYPICAL APPLICATION

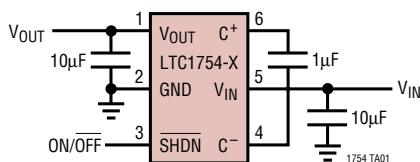

Regulated 3.3V Output from 2V to 4.4V Input

$$V_{OUT} = 3.3V \pm 4\%$$

$$I_{OUT} = 0mA \text{ TO } 20mA, V_{IN} > 2.0V$$

$$I_{OUT} = 0mA \text{ TO } 40mA, V_{IN} > 2.5V$$

Regulated 5V Output from 2.7V to 5.5V Input

$$V_{OUT} = 5V \pm 4\%$$

$$I_{OUT} = 0mA \text{ TO } 25mA, V_{IN} > 2.7V$$

$$I_{OUT} = 0mA \text{ TO } 50mA, V_{IN} > 3.0V$$

LTC1754-3.3
Output Voltage vs Supply Voltage

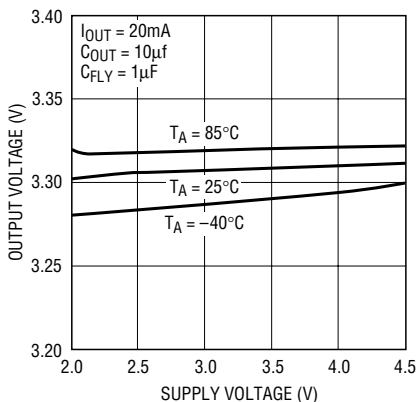

1754 TA02

LTC1754-5
Output Voltage vs Supply Voltage

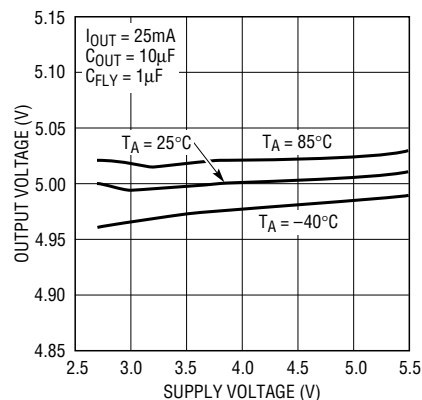

1754 TA03

ABSOLUTE MAXIMUM RATINGS

(Note 1)

V_{IN} to GND	-0.3V to 6V
V_{OUT} to GND	-0.3V to 6V
SHDN to GND	-0.3V to 6V
I_{OUT} (Note 4)	75mA
V_{OUT} Short-Circuit Duration	Indefinite
Operating Temperature Range (Note 3) ...	-40°C to 85°C
Storage Temperature Range	-65°C to 150°C
Lead Temperature (Soldering, 10 sec)	300°C

PACKAGE/ORDER INFORMATION

<p>S6 PACKAGE 6-LEAD PLASTIC SOT-23 $T_{JMAX} = 150^{\circ}C$, $\theta_{JA} = 230^{\circ}C/W$</p>	ORDER PART NUMBER
	LTC1754ES6-3.3 LTC1754ES6-5
	S6 PART MARKING
	LTKG LTLW

Consult factory for Industrial and Military grade parts.

ELECTRICAL CHARACTERISTICS

The ● denotes specifications which apply over the full operating temperature range, otherwise specifications are at $T_A = 25^{\circ}C$. $C_{FLY} = 1\mu F$ (Note 2), $C_{IN} = 10\mu F$, $C_{OUT} = 10\mu F$.

SYMBOL	PARAMETER	CONDITIONS	MIN	TYP	MAX	UNITS	
LTC1754-3.3							
V_{IN}	Input Supply Voltage		●	2.0	4.4	V	
V_{OUT}	Output Voltage	$2.0V \leq V_{IN} \leq 4.4V$, $I_{OUT} \leq 20mA$ $2.5V \leq V_{IN} \leq 4.4V$, $I_{OUT} \leq 40mA$	●	3.17	3.30	3.43	V
I_{CC}	Operating Supply Current	$2.0V \leq V_{IN} \leq 4.4V$, $I_{OUT} = 0mA$, $\overline{SHDN} = V_{IN}$	●	11	30	μA	
V_R	Output Ripple	$V_{IN} = 2.5V$, $I_{OUT} = 40mA$		23		mV _{p-p}	
η	Efficiency	$V_{IN} = 2.0V$, $I_{OUT} = 20mA$		82		%	
f_{OSC}	Switching Frequency	Oscillator Free Running		600		kHz	
t_{ON}	V_{OUT} Turn-On Time	$V_{IN} = 2.0V$, $I_{OUT} = 0mA$		0.8		ms	
I_{SC}	Output Short-Circuit Current	$V_{IN} = 2.5V$, $V_{OUT} = 0V$, $\overline{SHDN} = 2.5V$		118		mA	
LTC1754-5							
V_{IN}	Input Supply Voltage		●	2.7	5.5	V	
V_{OUT}	Output Voltage	$2.7V \leq V_{IN} \leq 5.5V$, $I_{OUT} \leq 25mA$ $3.0V \leq V_{IN} \leq 5.5V$, $I_{OUT} \leq 50mA$	●	4.8	5.0	5.2	V
I_{CC}	Operating Supply Current	$2.7V \leq V_{IN} \leq 5.5V$, $I_{OUT} = 0mA$, $\overline{SHDN} = V_{IN}$	●	13	30	μA	
V_R	Output Ripple	$V_{IN} = 3V$, $I_{OUT} = 50mA$		65		mV _{p-p}	
η	Efficiency	$V_{IN} = 3V$, $I_{OUT} = 50mA$		82.7		%	
f_{OSC}	Switching Frequency	Oscillator Free Running		700		kHz	
t_{ON}	V_{OUT} Turn-On Time	$V_{IN} = 3V$, $I_{OUT} = 0mA$		0.4		ms	
I_{SC}	Output Short-Circuit Current	$V_{IN} = 3V$, $V_{OUT} = 0V$, $\overline{SHDN} = 3V$		150		mA	
LTC1754-3.3/LTC1754-5							
I_{SHDN}	Shutdown Supply Current	$V_{IN} \leq 3.6V$, $I_{OUT} = 0mA$, $V_{SHDN} = 0V$ $3.6V < V_{IN}$, $I_{OUT} = 0mA$, $V_{SHDN} = 0V$	●	0.01	1	μA	
V_{IH}	\overline{SHDN} Input Threshold (High)		●	1.4		V	
V_{IL}	\overline{SHDN} Input Threshold (Low)		●		0.3	V	
I_{IH}	\overline{SHDN} Input Current (High)	$\overline{SHDN} = V_{IN}$	●	-1	1	μA	
I_{IL}	\overline{SHDN} Input Current (Low)	$\overline{SHDN} = 0V$	●	-1	1	μA	

Note 1: Absolute Maximum Ratings are those values beyond which the life of a device may be impaired.

Note 2: 0.6 μF is the minimum required C_{FLY} capacitance for rated output current capability. Depending on the choice of capacitor material, a somewhat higher value of capacitor may be required to attain 0.6 μF over temperature.

Note 3: The LTC1754ES6-X is guaranteed to meet performance specifications from 0°C to 70°C. Specifications over the -40°C to 85°C operating temperature range are assured by design, characterization and correlation with statistical process controls.

Note 4: Based on long term current density limitations.

TYPICAL PERFORMANCE CHARACTERISTICS LTC1754-3.3, $T_A = 25^\circ\text{C}$ unless otherwise noted.

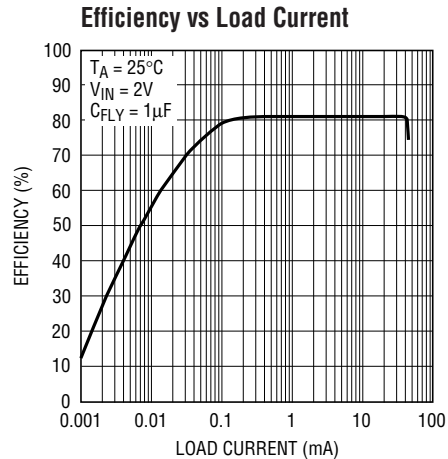
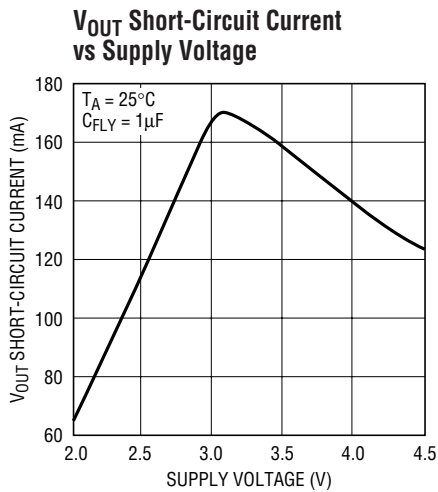
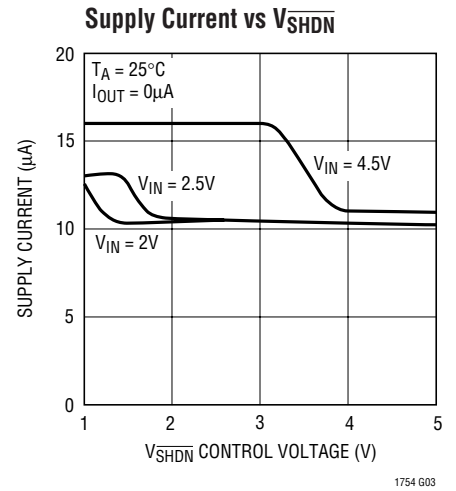
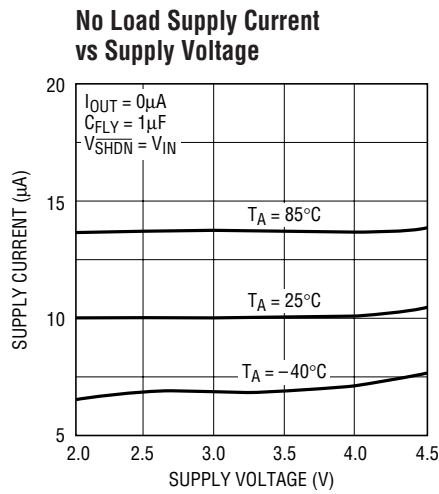
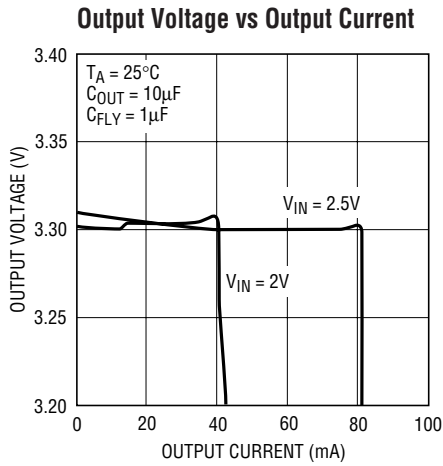

Load Transient Response

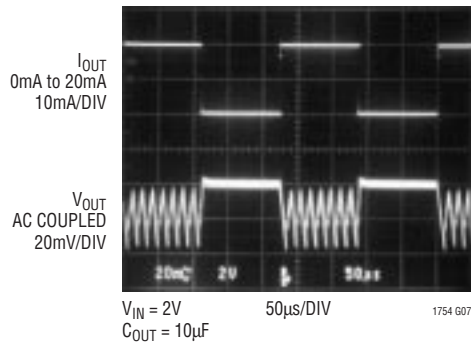

Output Ripple

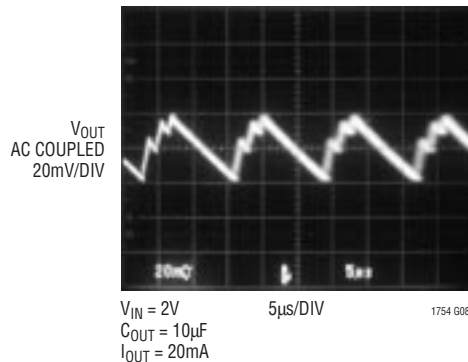

Start-Up Time

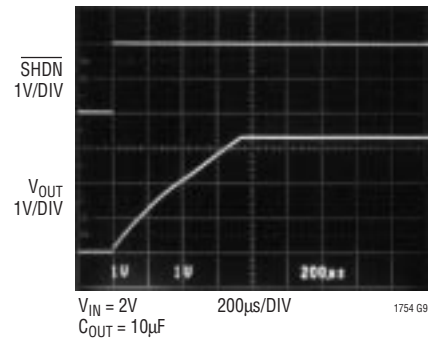

TYPICAL PERFORMANCE CHARACTERISTICS LTC1754-5, $T_A = 25^\circ\text{C}$ unless otherwise noted.

Output Voltage vs Output Current

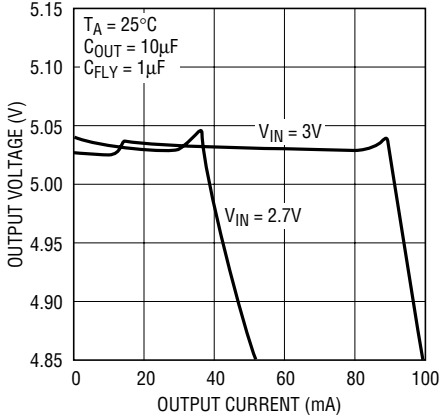

1574-5 G02

No Load Supply Current vs Supply Voltage

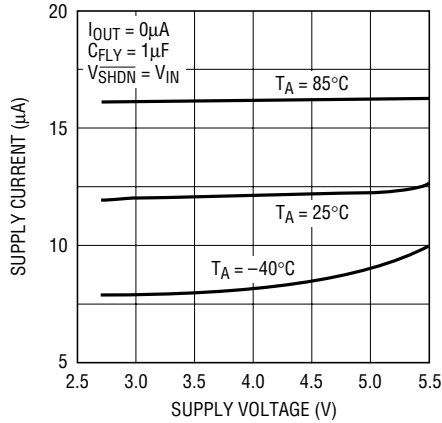

1754 G11

Supply Current vs $V_{\overline{\text{SHDN}}}$

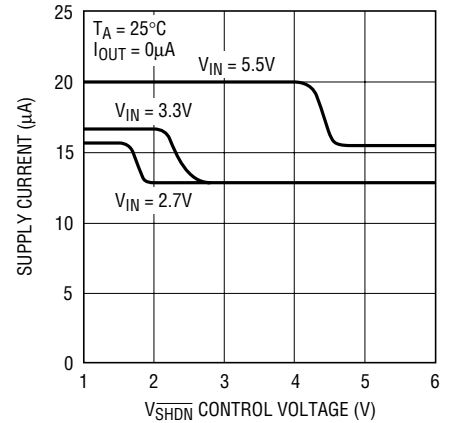

1574 G12

V_{OUT} Short-Circuit Current vs Supply Voltage

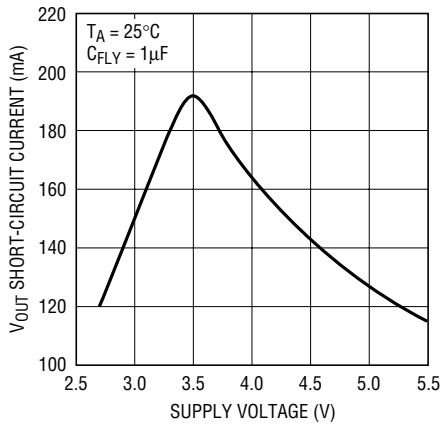

1754 G13

Efficiency vs Load Current

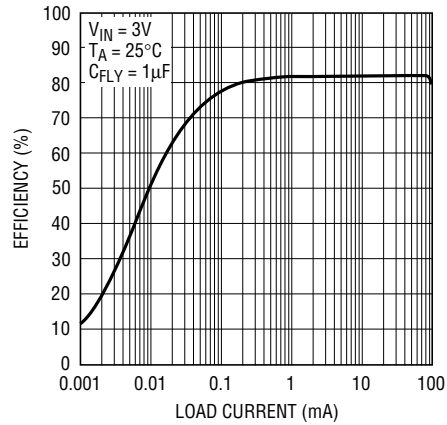

1754-5 G05

Load Transient Response

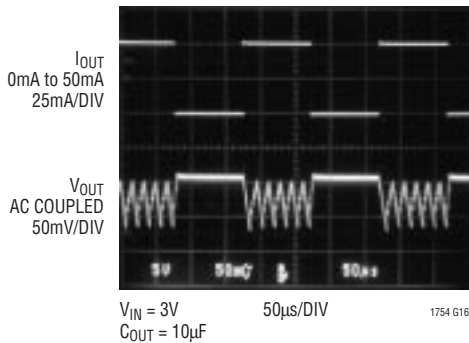

1754 G16

Output Ripple

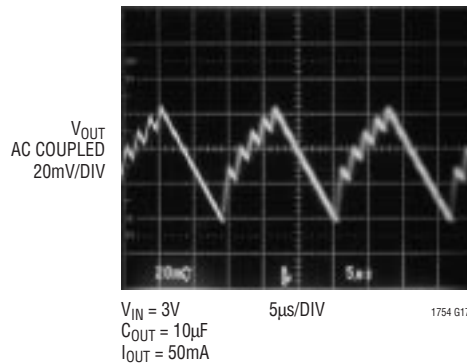

1754 G17

Start-Up Time

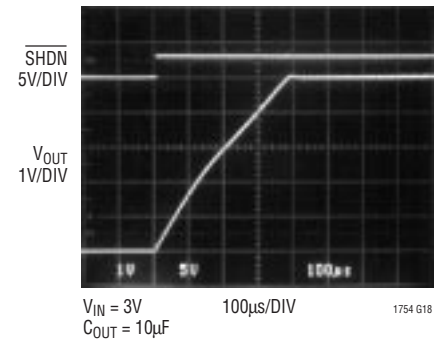

1754 G18

TYPICAL PERFORMANCE CHARACTERISTICS

LTC1754-3.3. LTC1754-5, $T_A = 25^\circ\text{C}$ unless otherwise noted.

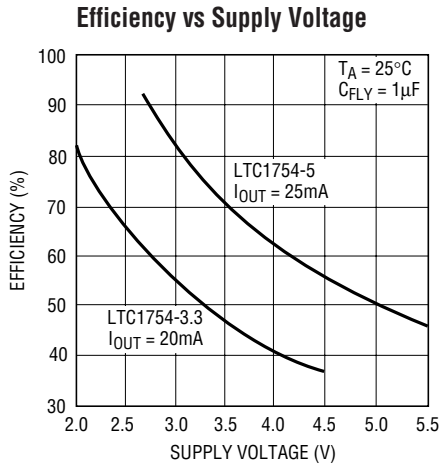

1754 G19

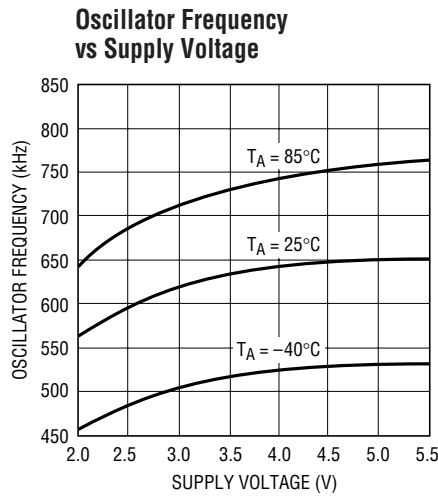

1754 G20

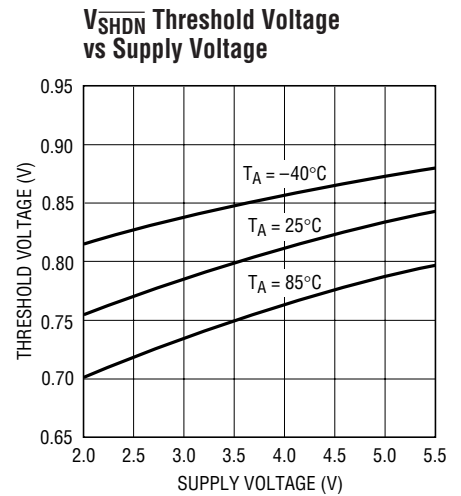

1754 G21

PIN FUNCTIONS

V_{OUT} (Pin 1): Regulated Output Voltage. For best performance, V_{OUT} should be bypassed with a $6.8\mu\text{F}$ (min) low ESR capacitor as close as possible to the pin.

GND (Pin 2): Ground. Should be tied to a ground plane for best performance.

SHDN (Pin 3): Active Low Shutdown Input. A low on SHDN disables the LTC1754. SHDN must not be allowed to float.

C⁻ (Pin 4): Flying Capacitor Negative Terminal.

V_{IN} (Pin 5): Input Supply Voltage. V_{IN} should be bypassed with a $6.8\mu\text{F}$ (min) low ESR capacitor.

C⁺ (Pin 6): Flying Capacitor Positive Terminal.

SIMPLIFIED BLOCK DIAGRAM

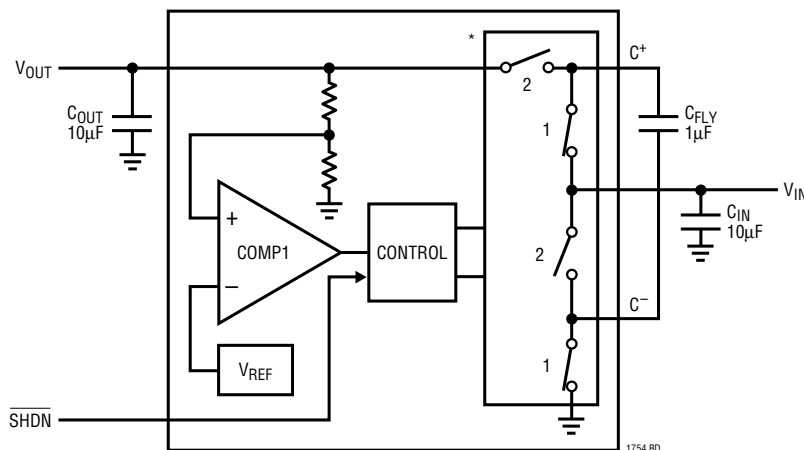

*CHARGE PUMP SHOWN IN PHASE 1, THE CHARGING PHASE. PHASE 1 IS ALSO THE SHUTDOWN PHASE

APPLICATIONS INFORMATION

Operation (Refer To Block Diagram)

The LTC1754 uses a switched-capacitor charge pump to boost V_{IN} to a regulated output voltage. Regulation is achieved by sensing the output voltage through an internal resistor divider and enabling the charge pump when the divided output drops below the lower trip point of COMP1. When the charge pump is enabled, a two-phase nonoverlapping clock activates the charge pump switches. The flying capacitor is charged to V_{IN} on phase one of the clock. On phase two of the clock it is stacked in series with V_{IN} and connected to V_{OUT} . This sequence of charging and discharging the flying capacitor continues at a free running frequency of 600kHz (typ). Once the attenuated output voltage reaches the upper trip point of COMP1, the charge pump is disabled. When the charge pump is disabled the LTC1754 draws only 13 μ A from V_{IN} thus providing high efficiency under low load conditions.

In shutdown mode all circuitry is turned off and the LTC1754 draws only leakage current from the V_{IN} supply. Furthermore, V_{OUT} is disconnected from V_{IN} . The SHDN pin is a CMOS input with a threshold voltage of approximately 0.8V, but may be driven to a logic level that exceeds V_{IN} . The LTC1754 is in shutdown when a logic low is applied to the SHDN pin. Since the SHDN pin is a high impedance CMOS input, it should never be allowed to float. To ensure that its state is defined, it must always be driven with a valid logic level.

Power Efficiency

The efficiency (η) of the LTC1754 is similar to that of a linear regulator with an effective input voltage of twice the actual input voltage. This results because the input current for a voltage doubling charge pump is approximately twice the output current. In an ideal voltage doubling regulator the power efficiency would be given by:

$$\eta = \frac{P_{OUT}}{P_{IN}} = \frac{(V_{OUT})(I_{OUT})}{(V_{IN})(2I_{OUT})} = \frac{V_{OUT}}{2V_{IN}}$$

At moderate-to-high output power, the switching losses and quiescent current of the LTC1754 are negligible and the expression above is valid. For example, an LTC1754-5 with

$V_{IN} = 3V$, $I_{OUT} = 25mA$ and V_{OUT} regulating to 5V, has a measured efficiency of 82.7%, which is in close agreement with the theoretical 83.3% calculation. The LTC1754 continues to maintain good efficiency even at fairly light loads because of its inherently low power design.

Short-Circuit/Thermal Protection

During short-circuit conditions, the LTC1754 will draw between 100mA and 400mA from V_{IN} causing a rise in the junction temperature. On-chip thermal shutdown circuitry disables the charge pump once the junction temperature exceeds approximately 150°C and reenables the charge pump once the junction temperature drops back to approximately 140°C. The LTC1754 will cycle in and out of thermal shutdown indefinitely without latchup or damage until the short circuit on V_{OUT} is removed.

Capacitor Selection

The style and value of capacitors used with the LTC1754 determine several important parameters such as output ripple, charge pump strength and turn-on time.

To reduce noise and ripple, it is recommended that low ESR (<0.1 Ω) capacitors be used for both C_{IN} and C_{OUT} . These capacitors should be either ceramic or tantalum and be 6.8 μ F or greater. Aluminum capacitors are not recommended because of their high ESR. If the source impedance to V_{IN} is very low up to several megahertz, C_{IN} may not be needed.

A ceramic capacitor is recommended for the flying capacitor with a value in the range of 1 μ F to 2.2 μ F. Note that a large value flying capacitor (>2.2 μ F) will increase output ripple unless C_{OUT} is also increased. For very low load applications, C_{FLY} may be reduced to 0.01 μ F to 0.047 μ F. This will reduce output ripple at the expense of maximum output current and efficiency.

In order to achieve the rated output current it is necessary to have at least 0.6 μ F of capacitance for the flying capacitor. Capacitors of different material lose their capacitance over temperature at different rates. For example, a ceramic capacitor made of X7R material will retain most of its capacitance from -40°C to 85°C, whereas a Z5U or Y5V style capacitor will lose considerable capacitance over that

APPLICATIONS INFORMATION

range. The capacitor manufacturer's data sheet should be consulted to determine what style and value of capacitor is needed to ensure $0.6\mu\text{F}$ at all temperatures.

Output Ripple

Low frequency *regulation mode* ripple exists due to the hysteresis in the sense comparator and propagation delay in the charge pump control circuit. The amplitude and frequency of this ripple are heavily dependent on the load current, the input voltage and the output capacitor size. For large V_{IN} the ripple voltage can become substantial because the increased strength of the charge pump causes fast edges that may outpace the regulation circuitry. Generally the regulation ripple has a sawtooth shape associated with it.

A high frequency ripple component may also be present on the output capacitor due to the charge transfer action of the charge pump. In this case the output can display a voltage pulse during the charging phase. This pulse results from the product of the charging current and the ESR of the output capacitor. It is proportional to the input voltage, the value of the flying capacitor and the ESR of the output capacitor.

Typical combined output ripple for the LTC1754-5 with $V_{\text{IN}} = 3\text{V}$ under maximum load is $65\text{mV}_{\text{p-p}}$ using a low ESR $10\mu\text{F}$ output capacitor. A smaller output capacitor and/or larger output current load will result in higher ripple due to higher output voltage slew rates.

There are several ways to reduce output voltage ripple. For applications requiring higher V_{IN} or lower peak-to-peak ripple, a larger C_{OUT} capacitor ($22\mu\text{F}$ or greater) is recommended. A larger capacitor will reduce both the low and high frequency ripple due to the lower charging and discharging slew rates, as well as the lower ESR typically found with higher value (larger case size) capacitors. A low ESR ceramic output capacitor will minimize the high frequency ripple, but will not reduce the low frequency ripple unless a high capacitance value is used. To reduce both the low and high frequency ripple, a reasonable compromise is to use a $10\mu\text{F}$ to $22\mu\text{F}$ tantalum capacitor in parallel with a $1\mu\text{F}$ to $3.3\mu\text{F}$ ceramic capacitor on V_{OUT} . An R-C filter may also be used to reduce high frequency voltage spikes (see Figure 1).

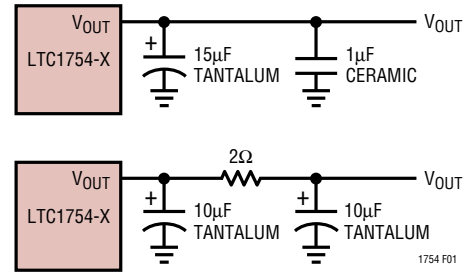

Figure 1. Output Ripple Reduction Techniques

In low load or high V_{IN} applications, smaller values for the flying capacitor may be used to reduce output ripple. A smaller flying capacitor ($0.01\mu\text{F}$ to $0.47\mu\text{F}$) delivers less charge per clock cycle to the output capacitor resulting in lower output ripple. However, with a smaller flying capacitor, the maximum available output current will be reduced along with the efficiency.

Note that when using a larger output capacitor the turn on time of the device will increase.

Inrush Currents

During normal operation V_{IN} will experience current transients in the 50mA to 100mA range whenever the charge pump is enabled. However during start-up, inrush currents may approach 250mA . For this reason it is important to minimize the source impedance between the input supply and the V_{IN} pin. Too much source impedance may result in regulation problems or prevent start-up.

Ultralow Quiescent Current Regulated Supply

The LTC1754 contains an internal resistor divider (refer to the Simplified Block Diagram) that typically draws $1.5\mu\text{A}$ from V_{OUT} . During no-load conditions, this internal load causes a droop rate of only 150mV per second on V_{OUT} with $C_{\text{OUT}} = 10\mu\text{F}$. Applying a 2Hz to 100Hz , 2% to 5% duty cycle signal to the SHDN pin ensures that the circuit of Figure 2 comes out of shutdown frequently enough to maintain regulation. Since the LTC1754 spends nearly the entire time in shutdown, the no-load quiescent current is approximately $(V_{\text{OUT}})(1.5\mu\text{A})/(\eta V_{\text{IN}})$.

The LTC1754 must be out of shutdown for a minimum duration of $200\mu\text{s}$ to allow enough time to sense the output voltage and keep it in regulation. A 2Hz , 2% duty cycle

APPLICATIONS INFORMATION

signal will keep V_{OUT} in regulation under no-load conditions. As the V_{OUT} load current increases, the frequency with which the LTC1754 is taken out of shutdown must also be increased.

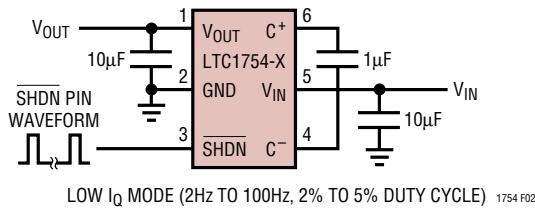

Figure 2. Ultralow Quiescent Current Regulated Supply

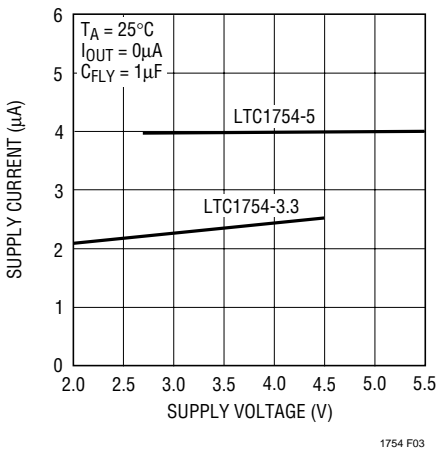

Figure 3. No-Load Supply Current vs Supply Voltage for the Circuit Shown in Figure 2

Layout Considerations

Due to high switching frequency and high transient currents produced by the LTC1754, careful board layout is necessary. A true ground plane and short connections to all capacitors will improve performance and ensure proper regulation under all conditions. Figure 4 shows the recommended layout configuration

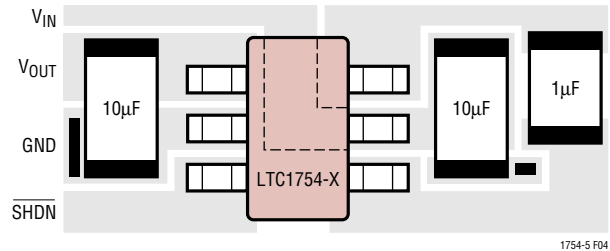

Figure 4. Recommended Layout

Thermal Management

For higher input voltages and maximum output current, there can be substantial power dissipation in the LTC1754. If the junction temperature increases above approximately 150°C, the thermal shutdown circuitry will automatically deactivate the output. To reduce the maximum junction temperature, a good thermal connection to the PC board is recommended. Connecting the GND pin (Pin 2) to a ground plane and maintaining a solid ground plane under the device on at least two layers of the PC board can reduce the thermal resistance of the package and PC board system to about 150°C/W.

TYPICAL APPLICATIONS

Low Power Battery Backup with Autoswitchover and No Reverse Current

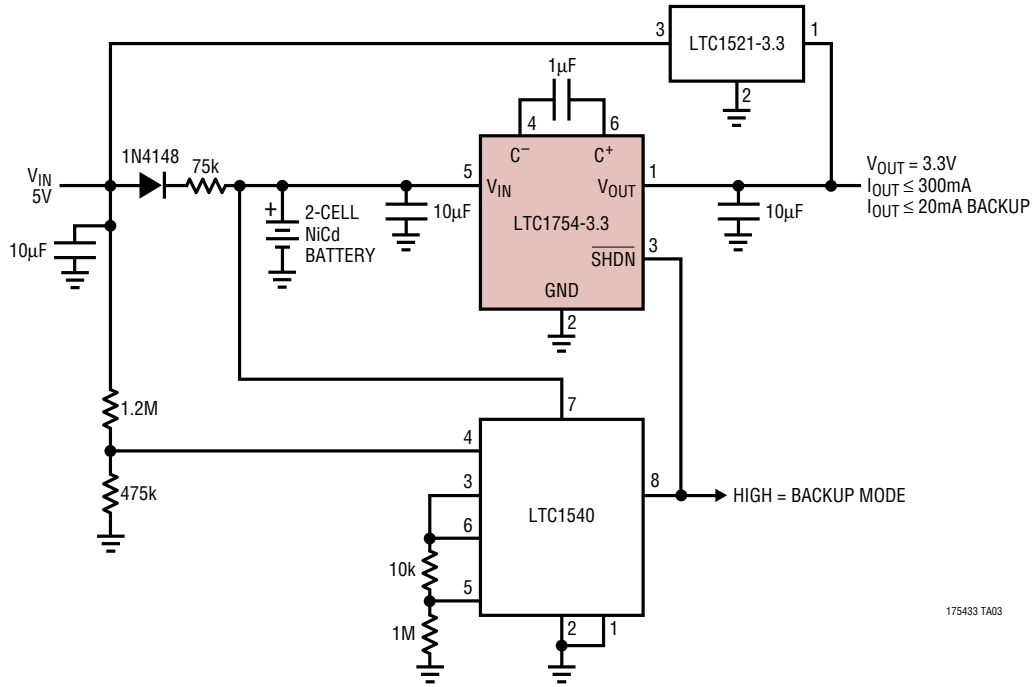

USB Port to Regulated 5V Power Supply

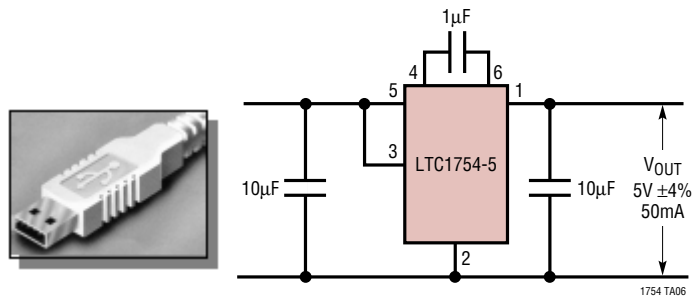

TYPICAL APPLICATIONS

5V, 100mA Step-Up Generator from 3V

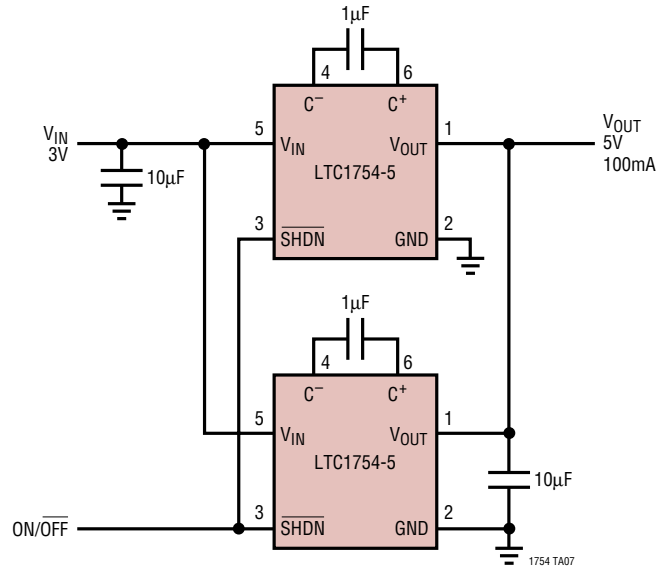

Lithium-Ion Battery to 5V White or Blue LED Driver

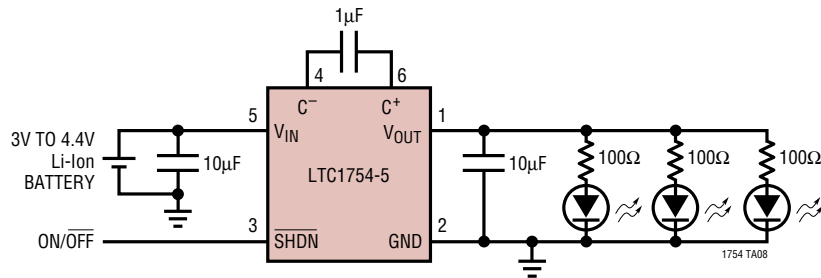

3.3V and 5V Step-Up Generator from 2V

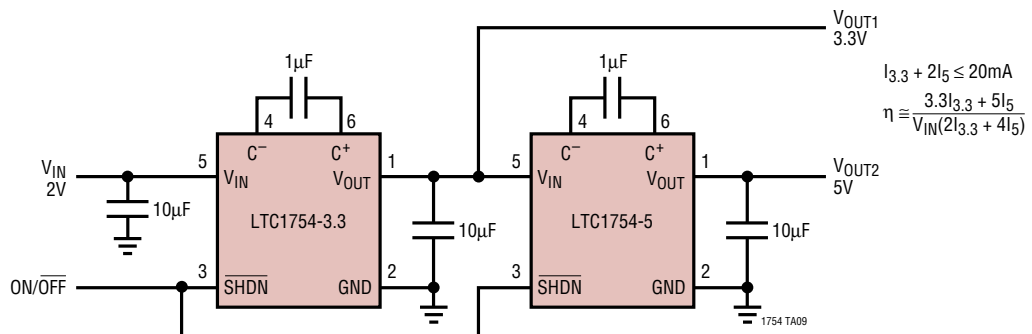

PACKAGE DESCRIPTION Dimensions in inches (millimeters), unless otherwise noted.

S6 Package
6-Lead Plastic SOT-23
 (LTC DWG # 05-08-1634)

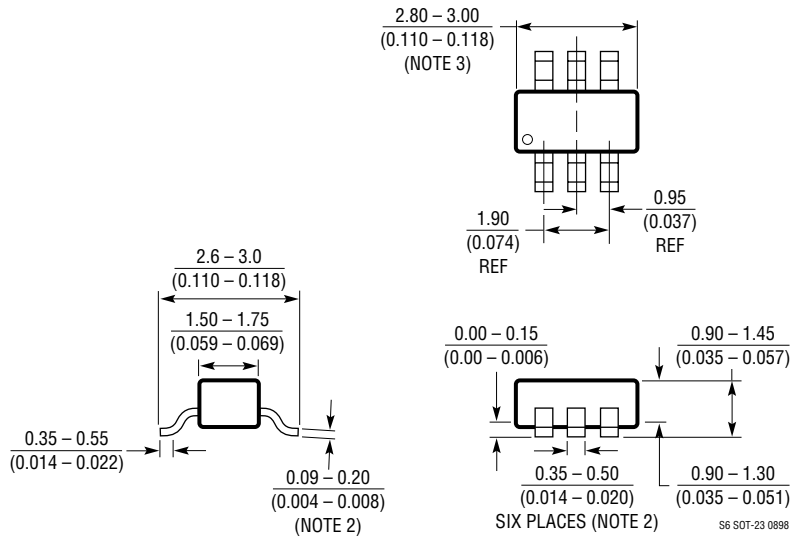

- NOTE:
1. DIMENSIONS ARE IN MILLIMETERS
 2. DIMENSIONS ARE INCLUSIVE OF PLATING
 3. DIMENSIONS ARE EXCLUSIVE OF MOLD FLASH AND METAL BURR
 4. MOLD FLASH SHALL NOT EXCEED 0.254mm
 5. PACKAGE EIAJ REFERENCE IS SC-74A (EIAJ)

TYPICAL APPLICATION

Low Power Battery Backup with Autoswitchover and No Reverse Current

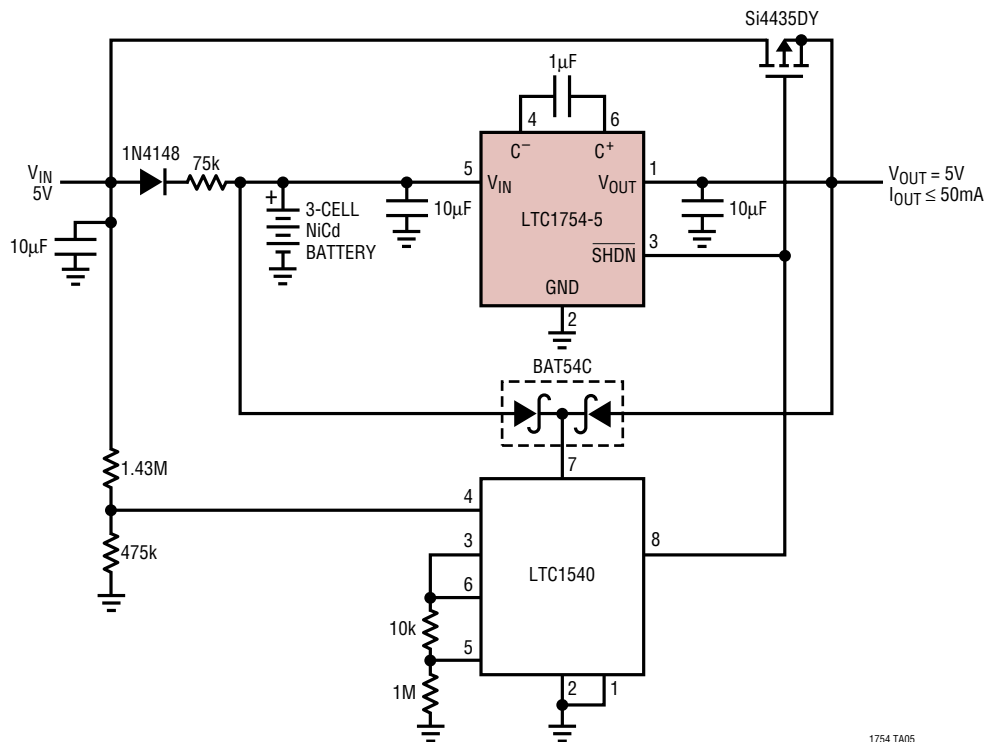

1754 TA05

RELATED PARTS

PART NUMBER	DESCRIPTION	COMMENTS
LT1054	High Power Doubler Charge Pump	Up to 100mA Output, $V_{IN} = 3.5V$ to $15V$, SO-8 Package
LTC1144	Charge Pump Inverter with Shutdown	$V_{IN} = 2V$ to $18V$, $15V$ to $-15V$ Supply
LTC1262	12V, 30mA Flash Memory Prog. Supply	Regulated $12V \pm 5\%$ Output, $I_Q = 500\mu A$
LTC1514/LTC1515	Buck/Boost Charge Pumps with $I_Q = 60\mu A$	50mA Output at 3V, 3.3V or 5V; 2V to 10V Input
LTC1516	Micropower 5V Charge Pump	$I_Q = 12\mu A$, Up to 50mA Output, $V_{IN} = 2V$ to $5V$
LTC1517-5/LTC1517-3.3	Micropower 5V/3.3V Doubler Charge Pumps	$I_Q = 6\mu A$, Up to 20mA Output
LTC1522	Micropower 5V Doubler Charge Pump	$I_Q = 6\mu A$, Up to 20mA Output
LT1615	Step-Up Switching Regulator in SOT-23	$I_Q = 20\mu A$, $V_{IN} = 1.2V$ to $15V$, Up to 34V Output
LTC1682	Low Noise Doubler Charge Pump	Output Noise = $60\mu V_{RMS}$, 2.5V to 5.5V Output