



YETDA INDUSTRY LTD.

Technical Data Sheet

MODEL NO : Q150OVS4

1206Package 3.2*1.6mm Chip LEDs

Features :

- Package in 8mm tape on 7 " diameter reel
- Compatible with automatic placement equipment
- Compatible with reflow solder process

Applications :

- Indicators
- Automotive : backlighting in dashboard and switch
- Backlight for LCD

Dice material	Emitted color	Lens Color
AlGaInP	Red	Water Clear

Electrical/Optical Characteristics(Ta=25)

Parameter	Symbol	Condition	Min	Typ.	Max	Unit
Luminous Internisity	Iv	IF=20mA	80	150		mcd
Dominant Wavelength	D	IF=20mA		625		nm
Peak Emission Wavelength	p	IF=20mA		632		nm
Viewing Angle	2 1/2	IF=20mA		130		Deg
Forward Voltage	VF	IF=20mA		2.0	2.4	V
Reverse Current	IR	VR=5V			10	μA

Absolute Maximum Ratings(Ta=25)

Parameter	Symbol	Maximum	Unit
Power Dissipation	Pd	78	mW
Peak Forward Current(1/10 Duty Cycle 0.1ms Pulse Width)	IF(Peak)	100	mA
Continuous Forward Current	IF	30	mA
Reverse Voltage	VR	5	V
Derating Linear From 25		0.3	mA/
Operating Temperature Range	Topr	-30 to +80	
Storage Temperature Range	Tstg	-40 to +90	

20090727



YETDA INDUSTRY LTD.

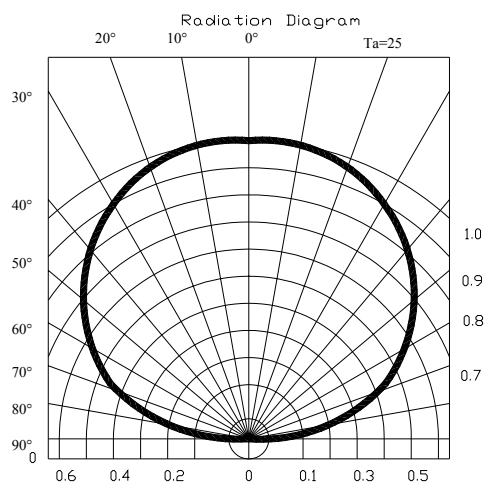
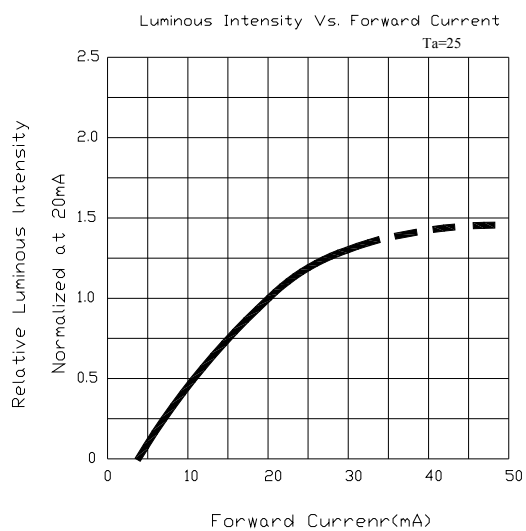
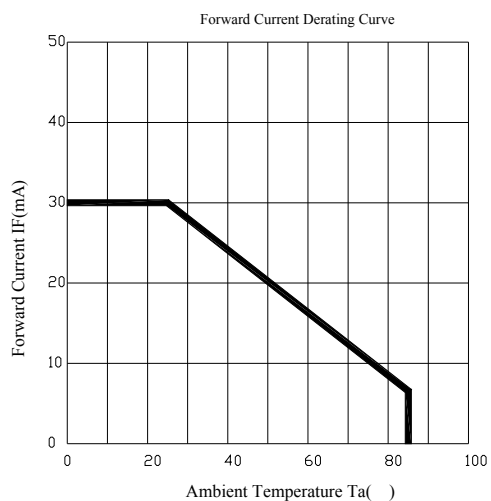
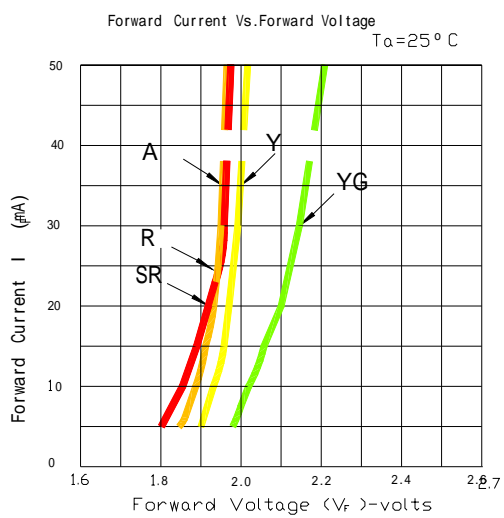
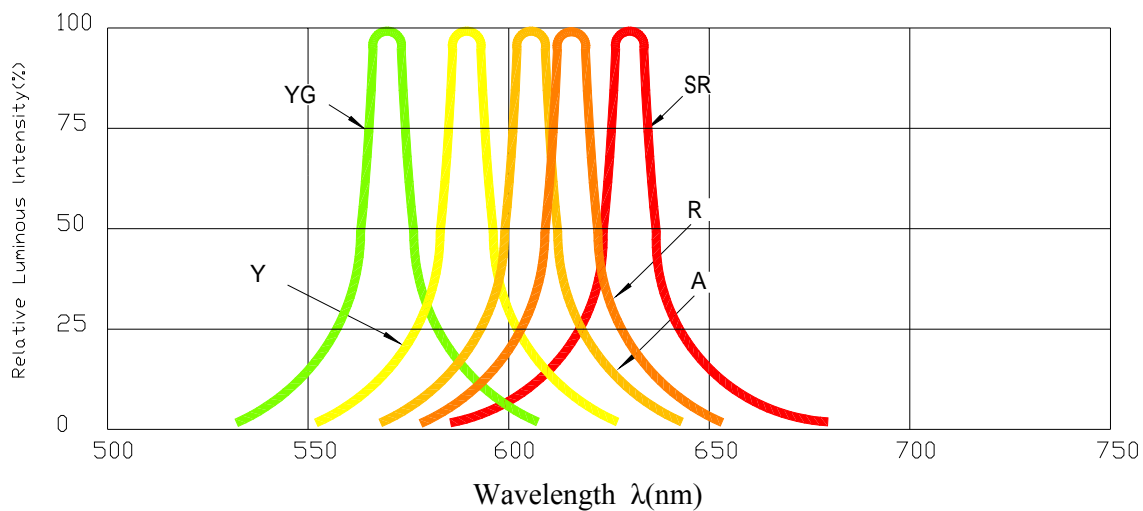



YETDA INDUSTRY LTD.

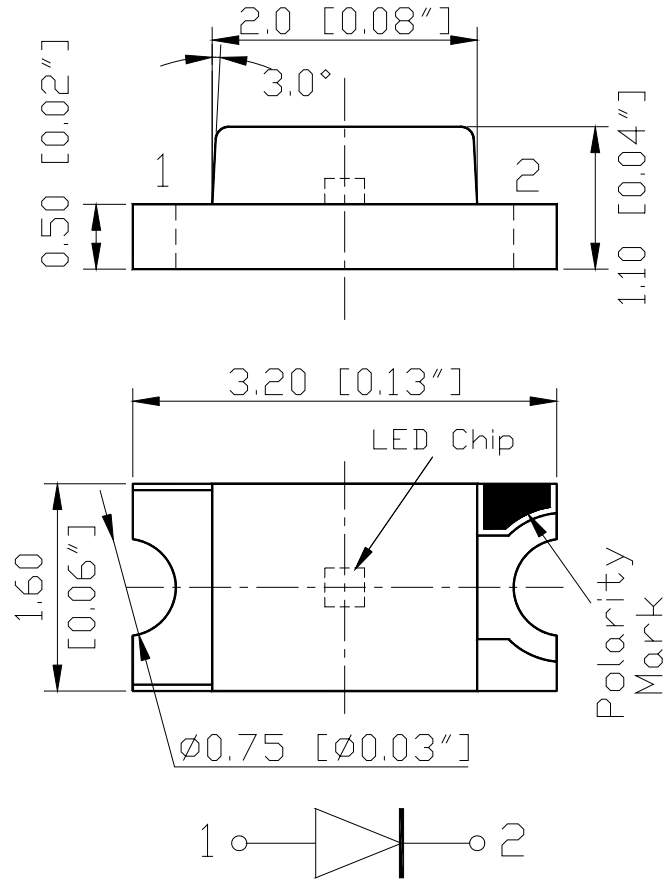

RECOMMEND PAD LAYOUT

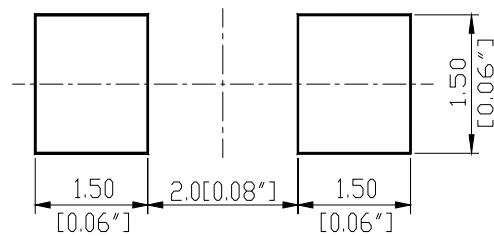



YETDA INDUSTRY LTD.

Descriptions :

- The Chip-LED Taping is much smaller than lead frame type components, thus enable smaller board size, higher packing density, reduced storage space and finally smaller equipment to be obtained.
- Besides, lightweight makes them ideal for miniature application, etc.

Soldering heat reliability (DIP):

Please refer to the following figure :

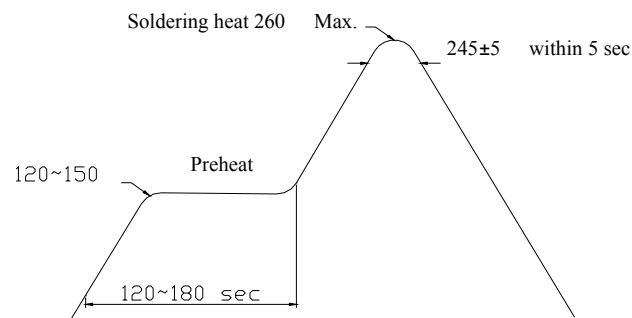

Precautions For Use :

- Over – current – proof
Customer must apply resistors for protection, otherwise slight voltage shift will cause big current change (Burn out will happen)
- Storage
 1. The operation of temperature and R.H. are : 5 30 , 60%R.H. Max..
 2. Once the package is opened, the products should be used within a week. Otherwise, they should be kept in a dampproof box with desiccating reagent. Considering the tape life, we suggest our customers to use our products within 1.5 year (from production date) .
 3. It's recommended to bake before soldering when the package is unsealed after 72 hrs. The condition is : 60 ±5 for 15hrs.



YETDA INDUSTRY LTD.

Test Circuit

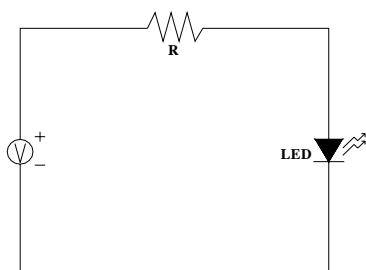

Reflow Temp. / Time :

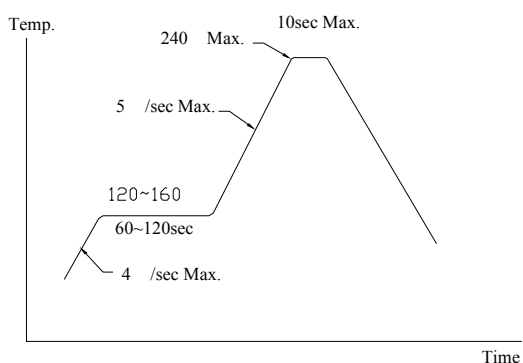

Reliability Test Items And Conditions

The reliability of products shall be satisfied with items listed below.

No.	Items	Test Condition	Test Hours/Cycles	Sample Size
1	Solder Heat	TEMP : 260 ±5	5 sec	48 pcs
2	Temperature Cycle	90 ~ 25 ~ -30 ~ 25 30m 5m 30m 5m	300Cycles	48 Pcs
3	Thermal Shick	100 ~ -55 10m 10m	100Cycles	48 Pcs
4	Operation Life	If=20mA	1000 Hrs	48 Pcs
5	High Temperature Storage	Temp:90	1000Hrs	48 Pcs
6	Low Temperature Storage	Temp:-30	1000Hrs	48 Pcs
7	High Temperature/High Humidity	80 / R.H80%	1000Hrs	48 Pcs



YETDA INDUSTRY LTD.