

General Description

The MIC5211 is a dual μ Cap 80mA linear voltage regulator with very low dropout voltage (typically 20mV at light loads), very low ground current (225 μ A at 20mA output current), and better than 3% initial accuracy. This dual device comes in the miniature SOT-23-6 package, featuring independent logic control inputs.

The μ Cap regulator design is optimized to work with low-value, low-cost ceramic capacitors. The outputs typically require only 0.1 μ F of output capacitance for stability.

Designed especially for hand-held, battery-powered devices, ground current is minimized using Micrel's proprietary Super β PNP™ technology to prolong battery life. When disabled, power consumption drops nearly to zero.

Key features include SOT-23-6 packaging, current limiting, overtemperature shutdown, and protection against reversed battery conditions.

The MIC5211 is available in dual 1.8V, 2.5V, 2.7V, 2.8V, 3.0V, 3.3V, 3.6V, and 5.0V versions. Certain mixed voltages are also available. Contact Micrel for other voltages.

Features

- Stable with low-value ceramic or tantalum capacitors
- Independent logic controls
- Low quiescent current
- Low dropout voltage
- Mixed voltages available
- Tight load and line regulation
- Low temperature coefficient
- Current and thermal limiting
- Reversed input polarity protection
- Zero off-mode current
- Dual regulator in tiny SOT-23 package
- 2.5V to 16V input range

Applications

- Cellular telephones
- Laptop, notebook, and palmtop computers
- Battery-powered equipment
- Bar code scanners
- SMPS post regulator/dc-to-dc modules
- High-efficiency linear power supplies

Typical Application

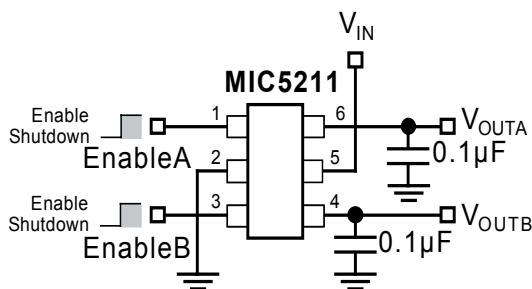

Ordering Information

Part Number		Pb-Free Part Number			Voltage Side A / Side B	Temperature Range	Package
Standard	Mark Code	Full	Manufacturing	Mark Code			
MIC5211-1.8BM6	LFBB	MIC5211-1.8YM6		LFBB	1.8V	0°C to +125°C	SOT-23-6
MIC5211-2.5BM6	LFCC	Contact Factory		LFCC	2.5V	-40°C to +125°C	SOT-23-6
MIC5211-2.7BM6	LFDD	MIC5211-2.7YM6		LFDD	2.7V	-40°C to +125°C	SOT-23-6
MIC5211-2.8BM6	LFEE	MIC5211-2.8YM6		LFEE	2.8V	-40°C to +125°C	SOT-23-6
MIC5211-3.0BM6	LFGG	MIC5211-3.0YM6		LFGG	3.0V	-40°C to +125°C	SOT-23-6
MIC5211-3.3BM6	LFLL	MIC5211-3.3YM6		LFLL	3.3V	-40°C to +125°C	SOT-23-6
MIC5211-3.6BM6	LFQQ	MIC5211-3.6YM6		LFQQ	3.6V	-40°C to +125°C	SOT-23-6
MIC5211-5.0BM6	LFXX	MIC5211-5.0YM6		LFXX	5.0V	-40°C to +125°C	SOT-23-6
Dual-Voltage Regulators							
MIC5211-1.8/2.5BM6	LFBC	MIC5211-1.8/2.5YM6	MIC5211-BCYM6	LFBC	1.8V / 2.5V	0°C to +125°C	SOT-23-6
MIC5211-1.8/3.3BM6	LFBL	MIC5211-1.8/3.3YM6	MIC5211-BLYM6	LFBL	1.8V / 3.3V	0°C to +125°C	SOT-23-6
MIC5211-2.5/3.3BM6	LFCL	MIC5211-2.5/3.3YM6	MIC5211-CLYM6	LFCL	2.5V / 3.3V	-40°C to +125°C	SOT-23-6
MIC5211-3.3/5.0BM6	LFLL	MIC5211-3.3/5.0YM6	MIC5211-LXYM6	LFLL	3.3V / 5.0V	-40°C to +125°C	SOT-23-6

Other voltages available. Contact Micrel for details.

Pin Configuration

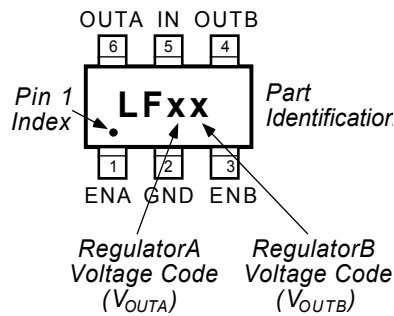

Voltage	Code
1.8V	B
2.5V	C
2.7V	D
2.8V	E
3V	G
3.15V	H
3.3V	L
3.6V	Q
5V	X

Pin Description

Pin Number	Pin Name	Pin Function
1	ENA	Enable/Shutdown A (Input): CMOS compatible input. Logic high = enable, logic low or open = shutdown.
2	GND	Ground
3	ENB	Enable/Shutdown B (Input): CMOS compatible input. Logic high = enable, logic low or open = shutdown.
4	OUTB	Regulator Output B
5	IN	Supply Input
6	OUTA	Regulator Output A

Absolute Maximum Ratings (Note 1)

Supply Input Voltage (V_{IN}).....	-20V to +20V
Enable Input Voltage (V_{EN})	-20V to +20V
Power Dissipation (P_D).....	Internally Limited
Storage Temperature Range	-60°C to +150°C
Lead Temperature (soldering, 5 sec.).....	260°C
ESD, (Note 3).....	

Operating Ratings (Note 2)

Supply Input Voltage (V_{IN}).....	2.5V to 16V
Enable Input Voltage (V_{EN})	0V to 16V
Junction Temperature (T_J) (except 1.8V)..	-40°C to +125°C
1.8V only.....	0°C to +125°C
6-lead SOT-23-6 (θ_{JA})	Note 4

Electrical Characteristics

$V_{IN} = V_{OUT} + 1V$; $I_L = 1mA$; $C_L = 0.1\mu F$, and $V_{EN} \geq 2.0V$; $T_J = 25^\circ C$, **bold** values indicate -40°C to +125°C; for one-half of dual MIC5211; unless noted.

Symbol	Parameter	Conditions	Min	Typical	Max	Units
V_O	Output Voltage Accuracy	variation from nominal V_{OUT}	-3		3	%
			-4		4	%
$\Delta V_O / \Delta T$ ppm/°C	Output Voltage Temperature Coefficient	Note 5		50	200	
$\Delta V_O / V_O$	Line Regulation	$V_{IN} = V_{OUT} + 1V$ to 16V		0.008	0.3 0.5	% %
$\Delta V_O / V_O$	Load Regulation	$I_L = 0.1mA$ to 50mA, Note 6		0.08	0.3 0.5	% %
$V_{IN} - V_O$	Dropout Voltage, Note 7	$I_L = 100\mu A$		20		mV
		$I_L = 20mA$		200	450	mV
		$I_L = 50mA$		250	500	mV
I_Q	Quiescent Current	$V_{EN} \leq 0.4V$ (shutdown)		0.01	10	μA
I_{GND}	Ground Pin Current Note 8	$V_{EN} \geq 2.0V$, $I_L = 100\mu A$ (active)		90		μA
		$I_L = 20mA$ (active)		225	450	μA
		$I_L = 50mA$ (active)		750	1200	μA
I_{LIMIT}	Current Limit	$V_{OUT} = 0V$		140	250	mA
$\Delta V_O / \Delta P_D$	Thermal Regulation	Note 9		0.05		%/W

Enable Input

V_{IL} V_{IH}	Enable Input Voltage Level	logic low (off)			0.6	V
		logic high (on)	2.0			V
I_{IL} I_{IH}	Enable Input Current	$V_{IL} \leq 0.6V$		0.01	1	μA
		$V_{IH} \geq 2.0V$		3	50	μA

Note 1: Exceeding the absolute maximum rating may damage the device.

Note 2: The device is not guaranteed to function outside its operating rating.

Note 3: Devices are ESD sensitive. Handling precautions recommended.

Note 4: The maximum allowable power dissipation at any T_A (ambient temperature) is $P_{D(max)} = (T_{J(max)} - T_A) / \theta_{JA}$. Exceeding the maximum allowable power dissipation will result in excessive die temperature, and the regulator will go into thermal shutdown. The θ_{JA} is 220°C/W for the SOT-23-6 mounted on a printed circuit board.

Note 5: Output voltage temperature coefficient is defined as the worst case voltage change divided by the total temperature range.

Note 6: Regulation is measured at constant junction temperature using low duty cycle pulse testing. Parts are tested for load regulation in the load range from 0.1mA to 50mA. Change in output voltage due to heating effects are covered by thermal regulation specification.

Note 7: Dropout voltage is defined as the input to output differential at which the output voltage drops 2% below its nominal value measured at 1V differential. For output voltages below 2.5V, dropout voltage is the input-to-output voltage differential with the minimum voltage being 2.5V. Minimum input operating voltage is 2.5V.

Note 8: Ground pin current is the quiescent current per regulator plus pass transistor base current. The total current drawn from the supply is the sum of the load current plus the ground pin current.

Note 9: Thermal regulation is defined as the change in output voltage at a time "t" after a change in power dissipation is applied, excluding load or line regulation effects. Specifications are for a 50mA load pulse at $V_{IN} = 16V$ for $t = 10ms$.

Typical Characteristics

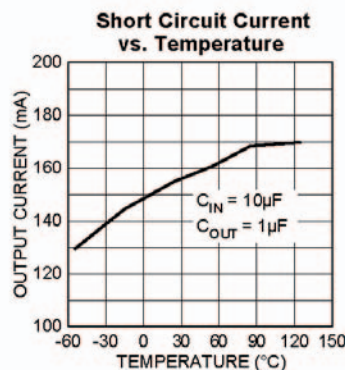
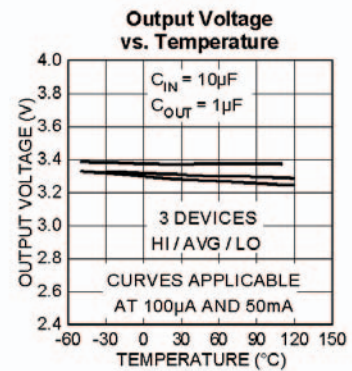
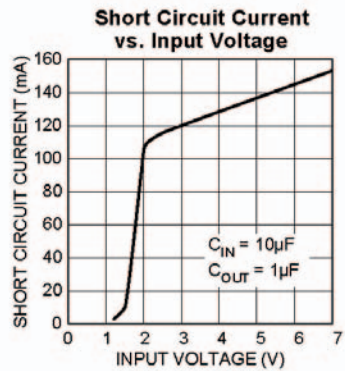
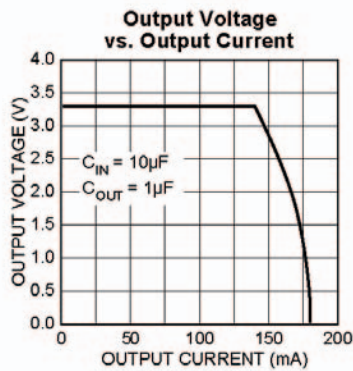
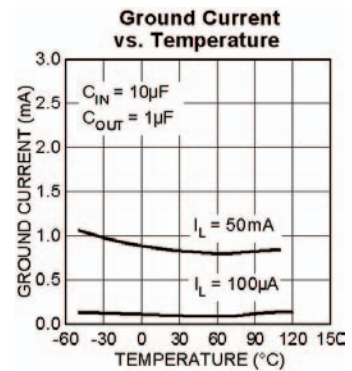
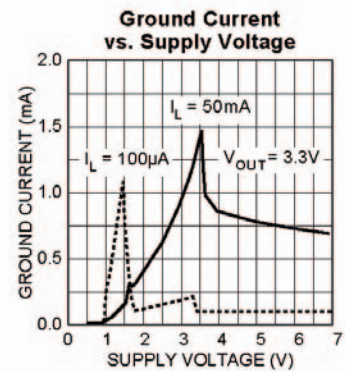
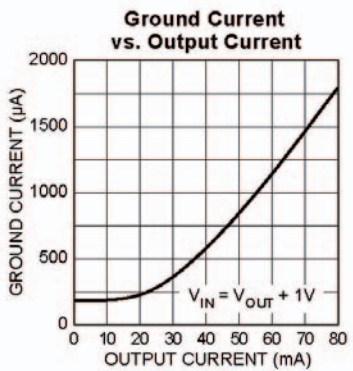
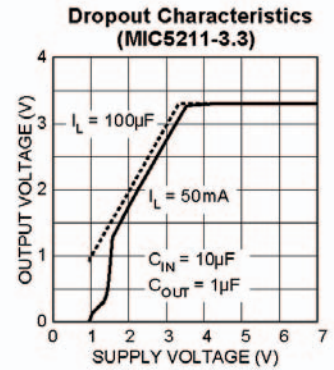
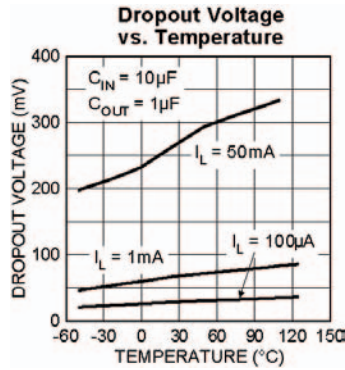
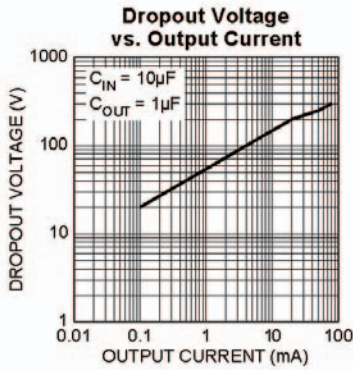

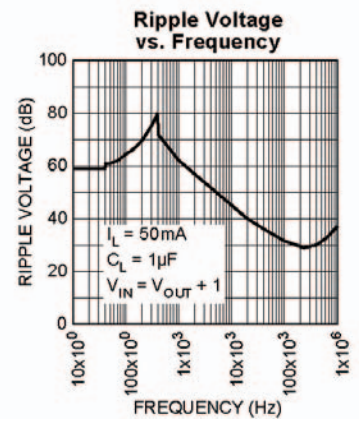
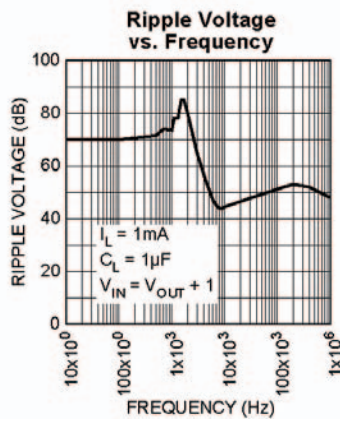
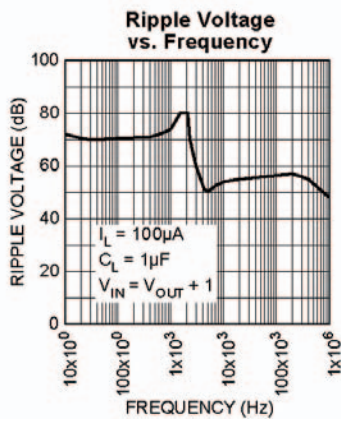
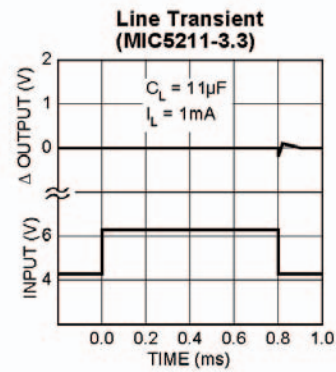
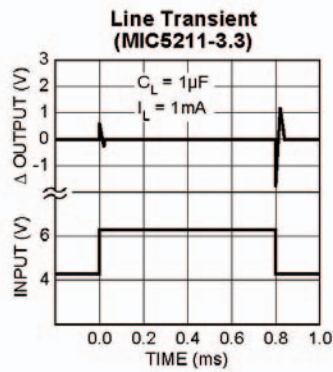
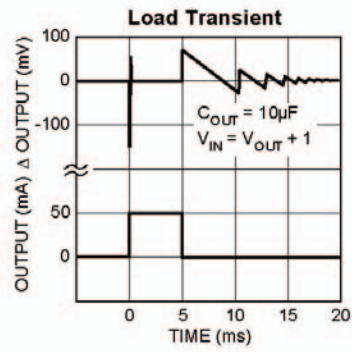
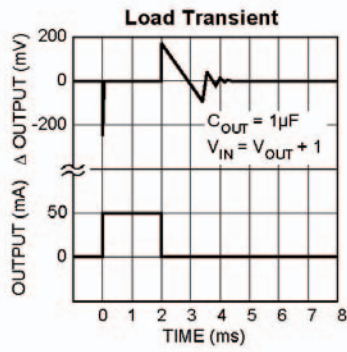

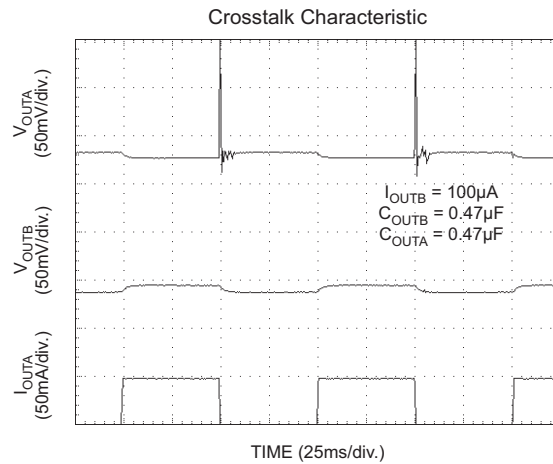
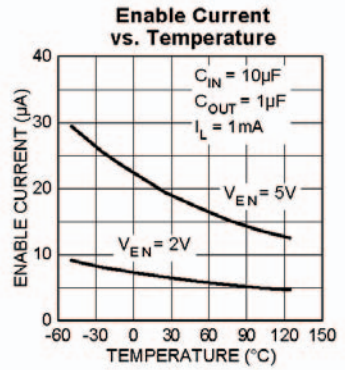
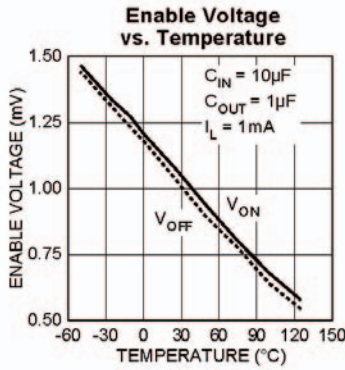
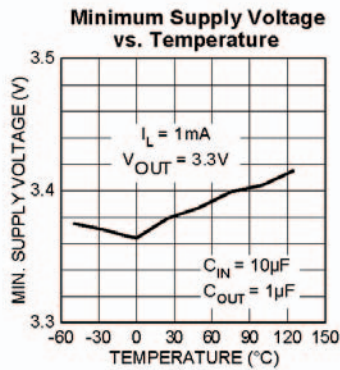
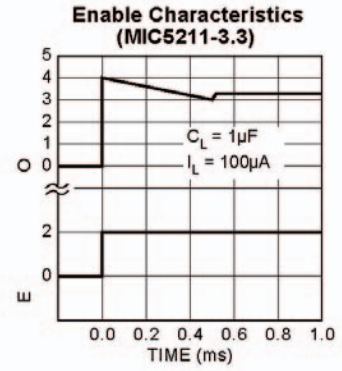
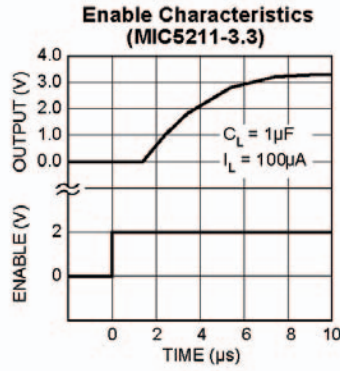
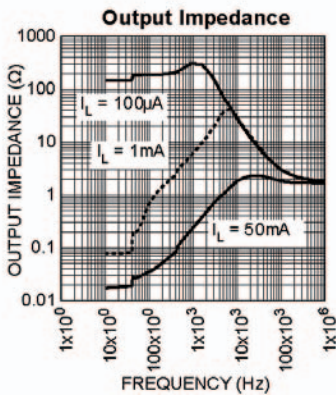

Applications Information

Enable/Shutdown

ENA and ENB (enable/shutdown) may be controlled separately. Forcing ENA/B high (>2V) enables the regulator. The enable inputs typically draw only 15µA.

While the logic threshold is TTL/CMOS compatible, ENA/B may be forced as high as 20V, independent of V_{IN} . ENA/B may be connected to the supply if the function is not required.

Input Capacitor

A 0.1µF capacitor should be placed from IN to GND if there is more than 10 inches of wire between the input and the ac filter capacitor or when a battery is used as the input.

Output Capacitor

Typical PNP based regulators require an output capacitor to prevent oscillation. The MIC5211 is ultrastable, requiring only 0.1µF of output capacitance per regulator for stability. The regulator is stable with all types of capacitors, including the tiny, low-ESR ceramic chip capacitors. The output capacitor value can be increased without limit to improve transient response.

The capacitor should have a resonant frequency above 500kHz. Ceramic capacitors work, but some dielectrics have poor temperature coefficients, which will affect the value of the output capacitor over temperature. Tantalum capacitors are much more stable over temperature, but typically are larger and more expensive. Aluminum electrolytic capacitors will also work, but they have electrolytes that freeze at about -30°C. Tantalum or ceramic capacitors are recommended for operation below -25°C.

No-Load Stability

The MIC5211 will remain stable and in regulation with no load (other than the internal voltage divider) unlike many other voltage regulators. This is especially important in CMOS RAM keep-alive applications.

Thermal Shutdown

Thermal shutdown is independent on both halves of the dual MIC5211, however, an overtemperature condition in one half may affect the other half because of proximity.

Thermal Considerations

When designing with a dual low-dropout regulator, both sections must be considered for proper operation. The part is designed with thermal shutdown, therefore, the maximum junction temperature must not be exceeded. Since the dual regulators share the same substrate, the total power dissipation must be considered to avoid thermal shutdown. Simple thermal calculations based on the power dissipation of both regulators will allow the user to determine the conditions for proper operation.

The maximum power dissipation for the total regulator system can be determined using the operating temperatures and the thermal resistance of the package. In a minimum footprint configuration, the SOT-23-6 junction-to-ambient thermal resistance (θ_{JA}) is 220°C/W. Since the maximum junction temperature for this device is 125°C, at an operating temperature of 25°C the maximum power dissipation is:

$$P_{D(max)} = \frac{T_{J(max)} - T_A}{\theta_{JA}}$$

$$P_{D(max)} = \frac{125^\circ\text{C} - 25^\circ\text{C}}{220^\circ\text{C/W}}$$

$$P_{D(max)} = 455\text{mW}$$

The MIC5211-3.0 can supply 3V to two different loads independently from the same supply voltage. If one of the regulators is supplying 50mA at 3V from an input voltage of 4V, the total power dissipation in this portion of the regulator is:

$$P_{D1} = (V_{IN} - V_{OUT}) I_{OUT} + V_{IN} \cdot I_{GND}$$

$$P_{D1} = (4\text{V} - 3\text{V}) 50\text{mA} + 4\text{V} \cdot 0.85\text{mA}$$

$$P_{D1} = 53.4\text{mW}$$

Up to approximately 400mW can be dissipated by the remaining regulator (455mW - 53.4mW) before reaching the thermal shutdown temperature, allowing up to 50mA of current.

$$P_{D2} = (V_{IN} - V_{OUT}) I_{OUT} + V_{IN} \cdot I_{GND}$$

$$P_{D2} = (4\text{V} - 3\text{V}) 50\text{mA} + 4\text{V} \cdot 0.85\text{mA}$$

$$P_{D2} = 53.4\text{mW}$$

The total power dissipation is:

$$P_{D1} + P_{D2} = 53.4\text{mW} + 53.4\text{mW}$$

$$P_{D1} + P_{D2} = 106.8\text{mW}$$

Therefore, with a supply voltage of 4V, both outputs can operate safely at room temperature and full load (50mA).

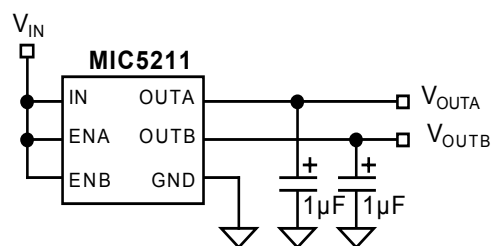

Figure 1. Thermal Conditions Circuit

In many applications, the ambient temperature is much higher. By recalculating the maximum power dissipation at 70°C ambient, it can be determined if both outputs can supply full load when powered by a 4V supply.

$$P_{D(max)} = \frac{T_{J(max)} - T_A}{\theta_{JA}}$$

$$P_{D(max)} = \frac{125^\circ\text{C} - 70^\circ\text{C}}{220^\circ\text{C/W}}$$

$$P_{D(max)} = 250\text{mW}$$

At 70°C, the device can provide 250mW of power dissipation, suitable for the above application.

When using supply voltages higher than 4V, do not exceed the maximum power dissipation for the device. If the device is operating from a 7.2V-nominal two-cell lithium-ion battery and

both regulators are dropping the voltage to 3.0V, then output current will be limited at higher ambient temperatures.

For example, at 70°C ambient the first regulator can supply 3.0V at 50mA output from a 7.2V supply; however, the second regulator will have limitations on output current to avoid thermal shutdown. The dissipation of the first regulator is:

$$P_{D1} = (7.2V - 3V) 50mA + 7.2V \cdot 0.85mA$$

$$P_{D1} = 216mW$$

Since maximum power dissipation for the dual regulator is 250mW at 70°C, the second regulator can only dissipate up to 34mW without going into thermal shutdown. The amount of current the second regulator can supply is:

$$P_{D2(max)} = 34mW$$

$$(7.2V - 3V) I_{OUT2(max)} = 34mW$$

$$4.2V \cdot I_{OUT2(max)} = 34mW$$

$$I_{OUT2(max)} = 8mA$$

The second regulator can provide up to 8mA output current, suitable for the keep-alive circuitry often required in hand-held applications.

Refer to Application Hint 17 for heat sink requirements when higher power dissipation capability is needed. Refer to Designing with Low Dropout Voltage Regulators for a more thorough discussion of regulator thermal characteristics.

Dual-Voltage Considerations

For configurations where two different voltages are needed in the system, the MIC5211 has the option of having two independent output voltages from the same input. For example, a 3.3V rail and a 5.0V rail can be supplied from the MIC5211 for systems that require both voltages. Important considerations must be taken to ensure proper functionality of the part. The input voltage must be high enough for the 5V section to operate correctly, this will ensure the 3.3V section proper operation as well.

Both regulators live off of the same input voltage, therefore the amount of output current each regulator supplies may be limited thermally. The maximum power the MIC5211 can dissipate at room temperature is 455mW, as shown in the "Thermal Considerations" section. If we assume 6V input voltage and 50mA of output current for the 3.3V section of the regulator, then the amount of output current the 5V section can provide can be calculated based on the power dissipation.

$$P_D = (V_{GND} - V_{OUT}) I_{OUT} + V_{GND} \cdot I_{GND}$$

$$P_{D(3.3V)} = (6V - 3.3V) 50mA + 6V \cdot 0.85mA$$

$$P_{D(3.3V)} = 140.1mW$$

$$P_{D(max)} = 455mW$$

$$P_{D(max)} - P_{D(3.3V)} = P_{D(5V)}$$

$$P_{D(5V)} = 455mW - 140.1mW$$

$$P_{D(5V)} = 314.9mW$$

Based on the power dissipation allowed for the 5V section, the amount of output current it can source is easily calculated.

$$P_{D(5V)} = 314.9mW$$

$$314.9mW = (6V - 5V) I_{MAX} - 6V \cdot I_{GND}$$

(I_{GND} typically adds less than 5% to the total power dissipation and in this case can be ignored)

$$314.9mW = (6V - 5V) I_{MAX}$$

$$I_{MAX} = 314.9mA$$

I_{MAX} exceeds the maximum current rating of the device. Therefore, for this condition, the MIC5211 can supply 50mA of output current from each section of the regulator.

Package Information

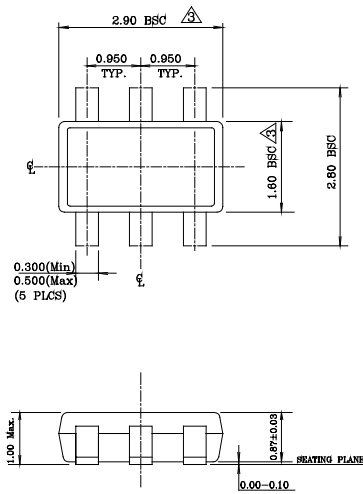

NOTE:

1. Dimensions and tolerances are as per ANSI Y14.5M, 1994.
2. Die is facing up for mold. Die is facing down for trim/form, ie. reverse trim/form.
3. Dimensions are exclusive of mold flash and gate burr.
4. The footlength measuring is based on the gauge plane method.
5. All specification comply to Jeduc Spec MO193 Issue C.
6. All dimensions are in millimeters.

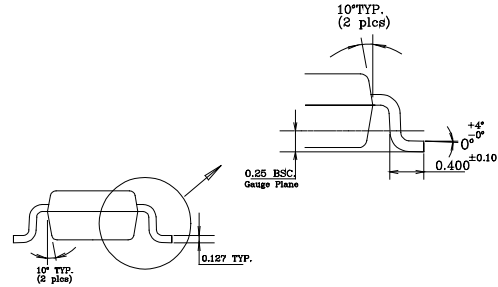

SOT-23-6 (M6)

MICREL INC. 2180 FORTUNE DRIVE SAN JOSE, CA 95131 USA
 TEL + 1 (408) 944-0800 FAX + 1 (408) 474-1000 WEB <http://www.micrel.com>

This information furnished by Micrel in this data sheet is believed to be accurate and reliable. However no responsibility is assumed by Micrel for its use. Micrel reserves the right to change circuitry and specifications at any time without notification to the customer.

Micrel Products are not designed or authorized for use as components in life support appliances, devices or systems where malfunction of a product can reasonably be expected to result in personal injury. Life support devices or systems are devices or systems that (a) are intended for surgical implant into the body or (b) support or sustain life, and whose failure to perform can be reasonably expected to result in a significant injury to the user. A Purchaser's use or sale of Micrel Products for use in life support appliances, devices or systems is a Purchaser's own risk and Purchaser agrees to fully indemnify Micrel for any damages resulting from such use or sale.