



American Opto Plus LED Corp.

L234NEC-TR

3.8 x 1.2 x 0.6 Red SMD, Tape and Reel

PACKAGE OUTLINES

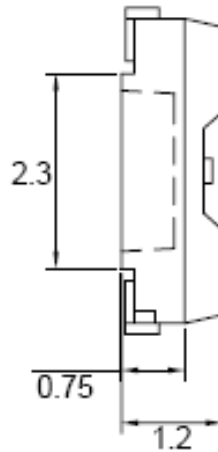
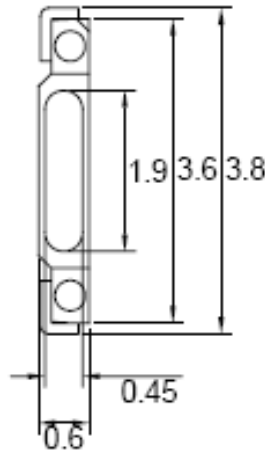
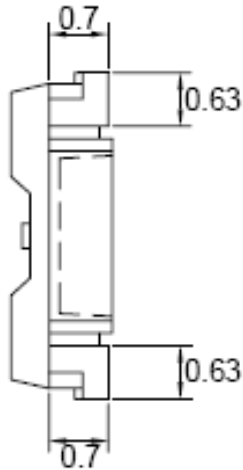

Cathode



Anode

Polarity

RECOMMEND PAD LAYOUT

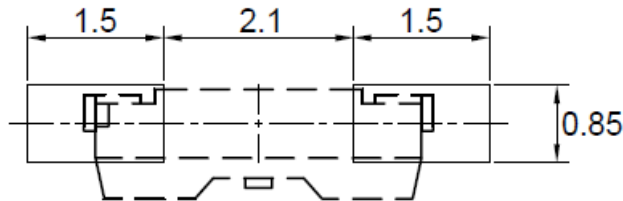

NOTES:

1. All dimensions are in millimeters tolerance is ± 0.2 mm unless otherwise noted; Angle ± 0.5 . Unit=mm.

Part Number	Material	Lens Color	
		Emitted	Lens
L234NEC-TR	AlGaInP	Red	Water Clear



American Opto Plus LED Corp.

L234NEC-TR

3.8 x 1.2 x 0.6 Red SMD, Tape and Reel

ABSOLUTE MAXIMUM RATINGS

(Ta=25°C)

Parameter	Symbol	Ratings	Unit
Power Dissipation	PD	72	mW
Peak Forward Current (Duty 1/11@10KHz)	I _{fp}	60	mA
Forward Current	I _f	30	mA
Reverse Current @ 5V	I _r	10	μA
Electrostatic Discharge	ESD	2000	V
Operating temperature range	T _{opr}	-40~+85	°C
Storage temperature range	T _{stg}	-40~+100	°C

OPTICAL-ELECTRICAL CHARACTERISTICS

(Ta=25°C)

Parameter	Symbol	Test Condition	Min	Typ	Max	Unit
Luminous Intensity	I _v	I _F =20mA	200	320	--	mcd
Dominant Wavelength	λ _D		--	625	--	nm
Spectral Line Half-Width	Δλ		--	20	--	nm
Forward Voltage	V _f		1.5	--	2.4	V
Viewing angle	2θ ½		--	120	--	Deg

- *Note: 1. The forward voltage data did not include ±0.1V testing tolerance.
2. The luminous intensity data did not include ±15% testing tolerance.



American Opto Plus LED Corp.

L234NEC-TR

3.8 x 1.2 x 0.6 Red SMD, Tape and Reel

TYPICAL ELECTRO-OPTICAL CHARACTERISTIC CURVES

Fig.1 Forward current vs. Forward Voltage

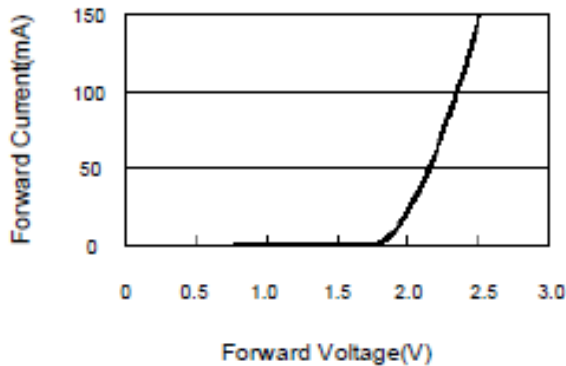

Fig.2 Luminous Intensity vs. Forward Current

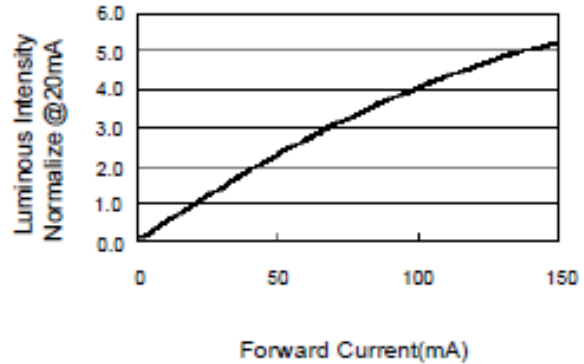

Fig.3 Forward Voltage vs. Temperature

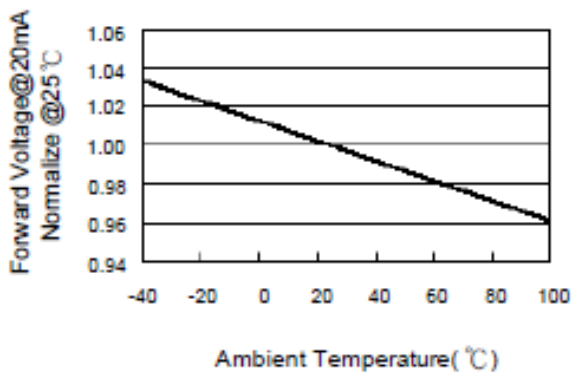

Fig.4 Luminous Intensity vs. Temperature

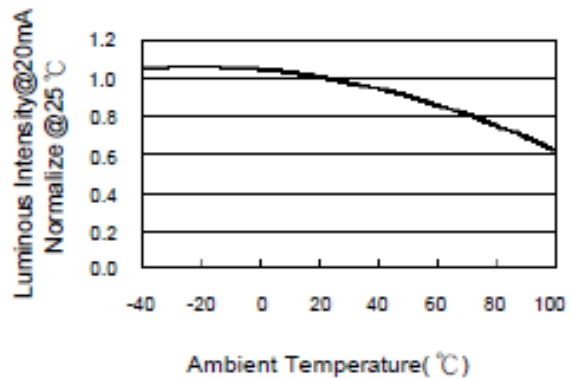

Fig.5 Relative Intensity vs. Wavelength

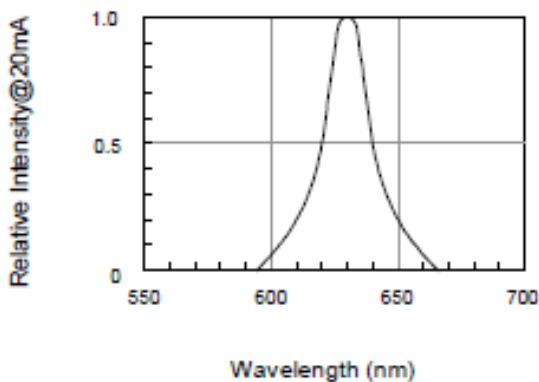
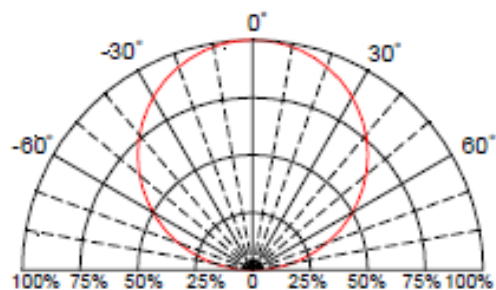

Fig.6 Directive Radiation





American Opto Plus LED Corp.

L234NEC-TR

3.8 x 1.2 x 0.6 Red SMD, Tape and Reel

LUMINOUS INTENSITY CLASSIFICATION

BIN CODE	Iv(mcd) @ 20mA	
	Min.	Max.
S	200	320
T	320	500
U	500	800



American Opto Plus LED Corp.

L234NEC-TR

3.8 x 1.2 x 0.6 Red SMD, Tape and Reel

CARRIER TAPE DIMENSION

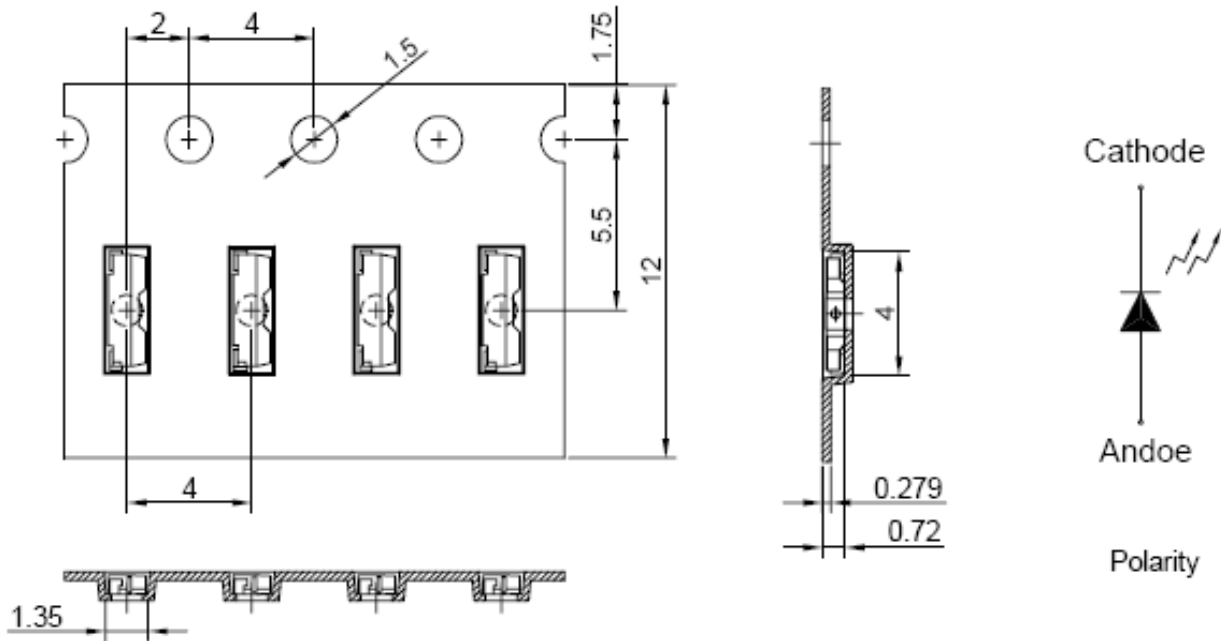

Note: The tolerances unless mentioned are ± 0.1 mm, Angle ± 0.5 ; Unit=mm

REEL DIMENSIONS

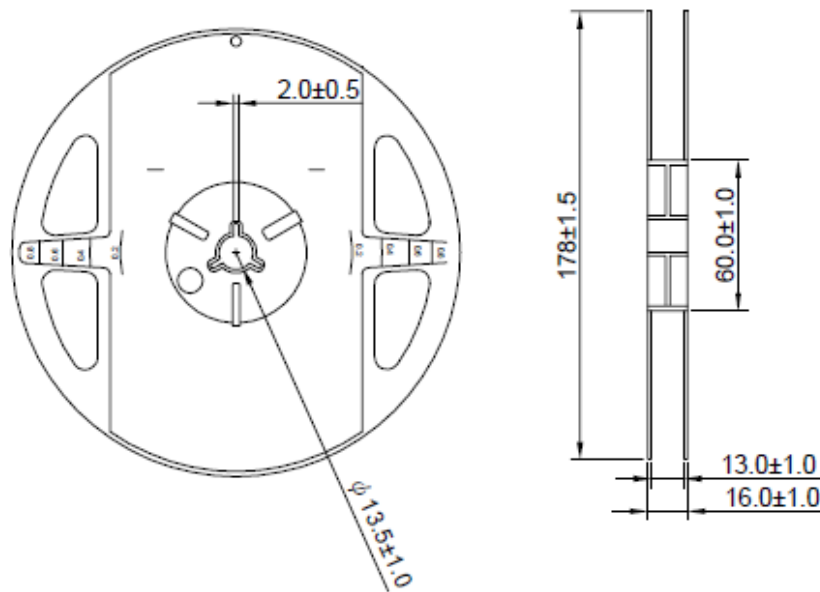

Notes:

1. 3000 pieces per reel.

Version 1.0 Date: 9-28-2012 Specifications are subject to change without notice.

American Opto Plus LED Corp. 1206 E. Lexington Ave., Pomona CA 91766 Tel: 909-465-0080 Fax: 909-465-0130 www.aopled.com



American Opto Plus LED Corp.

L234NEC-TR

3.8 x 1.2 x 0.6 Red SMD, Tape and Reel

RECOMMENDED SOLDERING CONDITIONS

1. Hand solder
Basic spec is $\leq 320^{\circ}\text{C}$ 3 sec one time only.
2. Wave solder

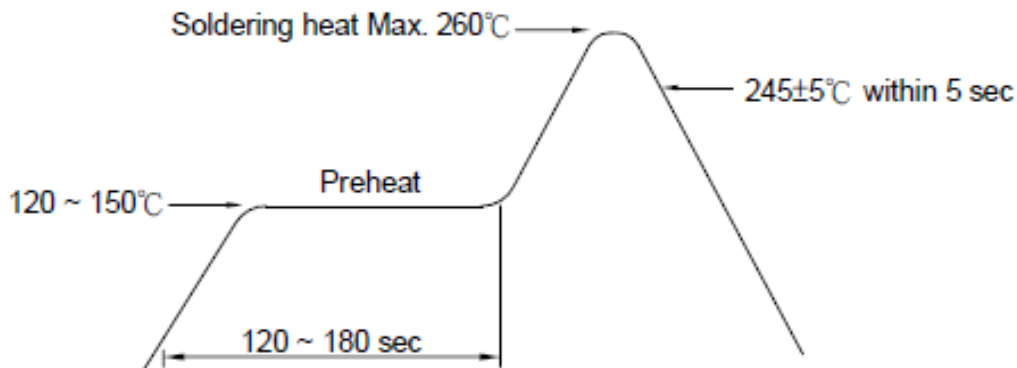

3. PB-Free reflow solder

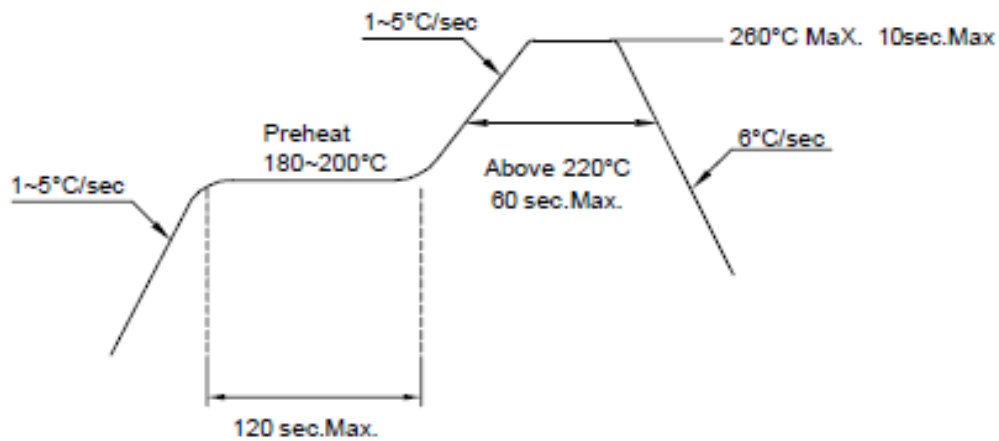

Notes:

1. Reflow soldering should not be done more than two times.
2. When soldering, do not put stress on the LEDs during heating.
3. After soldering, do not warp the circuit board.



American Opto Plus LED Corp.

L234NEC-TR

3.8 x 1.2 x 0.6 Red SMD, Tape and Reel

PRECAUTIONS FOR USE

Storage Time:

1. The operation of temperatures and RH are: 5°C~35°C, RH60%.
2. Once the package is opened, the products should be used within a week. Otherwise, they should be kept in a damp proof box with desiccating agent. Considering the tape life, we suggest our customers to use our products within a year (from production date).
3. If opened more than one week in an atmosphere 5°C~35°C, RH60%, they should be treated at 60°C±5°C for 15hrs.

Drive Method:

LED is a current operated device, and therefore, require some kind of current limiting incorporated into the driver circuit. This current limiting typically takes the form of a current limiting resistor placed in a series with the LED.

Consider worst case voltage variations that could occur across the current limiting resistor. The forward current should not be allowed to change by more than 40% of its desired value.

Circuit model A

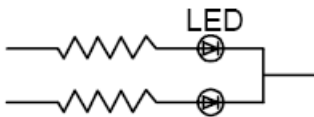

Circuit model B

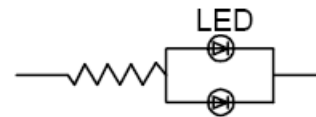

(A) Recommended circuit.

(B) The difference of brightness between LED could be found due to the VF-IF characteristics of LED.

Cleaning:

Use alcohol-based cleaning solvents such as isopropyl alcohol to clean the LED.

ESD(Electrostatic Discharge):

Static Electricity or power surge will damage the LED. Use of a conductive wrist band or anti-electrostatic glove is recommended when handling these LEDs. All devices and machinery must be properly grounded.



American Opto Plus LED Corp.

L234NEC-TR

3.8 x 1.2 x 0.6 Red SMD, Tape and Reel

RELIABILITY TEST:

(1) Test items and results

Classification	Test Item	Test Conditions	Number of Damaged
Endurance Test	Operating Life Test	1. Ta=under room temperature as per data sheet maximum rating 2. If=20mA 3. t=1000 hrs	0/22
	High Temperature Storage Test	1. Ta=105°C±5°C 2. t=500 hrs	0/22
	Low Temperature Storage Test	1. Ta=40°C±5°C 2. t=1000 hrs	0/22
	High Temperature High Humidity Storage Test	1. IR-Reflow in-board, 2 times 2. Ta=85°C±5°C 3. RH=90%~95% 4. t=500hrs±2hrs	0/22
Environmental Test	Thermal Shock Test	1. IR-Reflow in-board, 2 times 2. Ta=105°C±5°C & -40°C±5°C (30min) (30min) 3. Total 100 cycles	0/22
	Reflow Soldering Test	1. T _{sol} =260°C±5°C 2. Dwell time = 10 max	0/22
	Temperature Cycling	1. 105°C ~ 25°C ~ -40°C 30 mins 15 mins 30 mins 2. 100 cycles	0/22

(2) Criteria for judging the damage

Item	Symbol	Test Conditions	Criteria for Judgement	
			Min.	Max.
Forward Voltage	V _f	If=20mA	--	U.S.L. x 1.2
Reverse Current	I _r	V _r =5V	--	U.S.L. x 2.0
Luminous Intensity	I _v	If=20mA	L.S.L. x 0.5	--

Note:

1. U.S.L.: Upper Standard Level. 2. L.S.L: Lower Standard Level