

General Description

The MIC2544A and MIC2548A are integrated, high-side power switches optimized for low loss DC power switching and other power management applications, including Advanced Configuration and Power Interface (ACPI). The MIC2544A/48A is a cost-effective, highly integrated solution that requires few external components to satisfy USB and ACPI requirements.

Load current management features include a precision resistor-programmable output current-limit and a soft-start circuit which minimizes inrush current when the switch is enabled. Thermal shutdown, along with current-limit, protects the switch and the attached device.

The MIC2544A/48A's open-drain flag output is used to indicate current-limiting or thermal shutdown to a local controller. The MIC2548A has an additional internal latch which turns the output off upon thermal shutdown providing robust fault control. The enable signal is compatible with both 3V and 5V logic, and is also used as the thermal shutdown latch reset for the MIC2548A.

The MIC2544A and MIC2548A are available in active-high and active-low enable versions in the 8-pin SOIC (small-outline integrated circuit) and 8-pin MSOP (micro-small-outline package).

Features

- 2.7V to 5.5V input
- Adjustable current-limit up to 1.5A
- Reverse current flow blocking (no "body diode")
- 90µA typical on-state supply current
- 1µA typical off-state supply current
- 120mΩ maximum on-resistance
- Open-drain fault flag
- Thermal shutdown
- Thermal shutdown output latch (MIC2548A)
- 2ms (slow) turn-on and fast turn-off
- Available with active-high or active-low enable

Applications

- USB power distribution
- PCI bus power switching
- Notebook PC
- ACPI power distribution
- PC card hot swap applications
- Inrush current-limiting

Typical Application

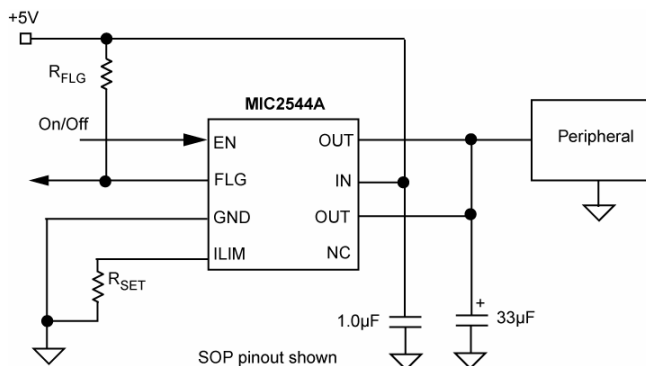

Typical Advanced Configuration and Power Interface (ACPI) Application

Ordering Information*

Part Number	Enable	Latch*	Temperature Range	Package	Pb-Free
MIC2544A-1YM	Active High		-40°C to +85°C	8-pin SOIC	■
MIC2544A-1YMM	Active High		-40°C to +85°C	8-pin MSOP	■
MIC2544A-2YM	Active Low		-40°C to +85°C	8-pin SOIC	■
MIC2544A-2YMM	Active Low		-40°C to +85°C	8-pin MSOP	■
MIC2548A-1YM	Active High	■	-40°C to +85°C	8-pin SOIC	■
MIC2548A-1YMM	Active High	■	-40°C to +85°C	8-pin MSOP	■
MIC2548A-2YM	Active Low	■	-40°C to +85°C	8-pin SOIC	■
MIC2548A-2YMM	Active Low	■	-40°C to +85°C	8-pin MSOP	■

*Thermal Shutdown Latch

Pin Configuration

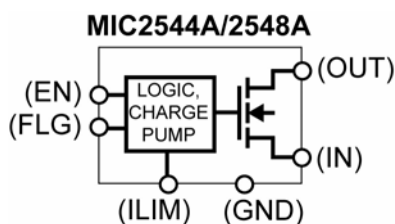
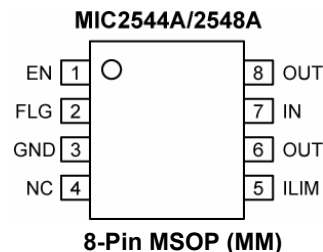
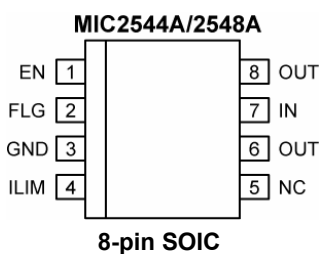

Note:

1. Pins 4 and 5 for SOIC and MSOP are different.

Pin Description

Pin Number MSOP-8	Pin Number SOIC-8	Pin Name	Pin Function
1	1	EN	Enable (Input): Logic-compatible enable input. Active-high (-1) or active-low (-2). High input >1.7V typical; low input <1.5V typical. Do not float. MIC2548A only: Also resets thermal shutdown latch.
2	2	FLG	Fault Flag (Output): Active-low, open-drain output. Indicates over current or thermal shutdown conditions. MIC2548A only: latched low on thermal shutdown.
3	3	GND	Ground.
5	4	ILIM	Current Limit: Sets current-limit threshold using an external resistor, R_{SET}^1 connected to ground. $154\Omega < R_{SET} < 2.29k\Omega$.
7	7	IN	Input: Output MOSFET drain. Also powers internal circuitry.
6,8	6,8	OUT	Switch (Output): Output MOSFET source. Pins 6 and 8 must be externally connected.
4	5	NC	Not internally connected.

Absolute Maximum Ratings⁽¹⁾

Supply Voltage (V_{IN})	-0.3V to 6.0V
Output Voltage (V_{OUT})	-0.3V to V_{IN}
Output Current (I_{OUT})	Internally Limited
Enable Input (V_{EN})	-0.3V to $V_{IN}+0.3V$
Fault Flag Voltage (V_{FLG})	-0.3V to 6V
Fault Flag Current (I_{FLG})	50mA
Storage Temperature (T_s)	-65°C to +150°C
Junction Temperature (T_J)	Internally Limited
Lead Temperature (soldering, 10 sec.)	260°C
ESD Rating ⁽³⁾	2kV

Operating Ratings⁽²⁾

Supply Voltage (V_{IN})	+2.7V to +5.5V
Enable Voltage (V_{EN})	0V to V_{IN}
Current Limit Set Range	0.1A to 1.5A
Ambient Temperature (T_A)	-40°C to +85°C
Package Thermal Resistance	
SOIC (θ_{JA})	160°C/W
MSOP (θ_{JA})	206°C/W

Electrical Characteristics

$V_{IN} = +5V$; $T_A = 25^\circ C$, **Bold** values indicate -40°C to +85°C, unless noted.

Parameter	Condition	Min	Typ	Max	Units
-----------	-----------	-----	-----	-----	-------

Power Input Supply

Input Voltage Range (V_{IN})		2.7		5.5	V
Shutdown Current	Switch off, $V_{OUT} = \text{Open}^{(4)}$		0.75	5	μA
Supply Current	Switch on, $V_{OUT} = \text{Open}^{(4)}$		90	160	μA

Enable Input

EN Logic Level High		2.4	1.7		V
EN Logic Level Low			1.5	0.8	V
En Bias Current	$V_{EN} = 2.4V^{(4)}$		0.1	1.0	μA
	$V_{EN} = 0.8V^{(4)}$		0.1	1.0	μA
EN Input Capacitance	(Note 5)		1		pF
EN Pulse Reset Width	MIC2548 Thermal Shutdown Latch ⁽⁵⁾	5			μs
V_{IN} to EN Set-Up	MIC2548 ⁽⁵⁾	0			μs

Internal Switch

On Resistance $R_{DS(ON)}$	$I_{OUT} = 500mA$		80	120	m Ω
Output Leakage Current	Switch off		1	10	μA

Current Limit

Current Limit Factor	$I_{OUT} = 100mA$ to $500mA$, $V_{OUT} = 1V$ to $4V^{(6)}$	161	230	299	V
	$I_{OUT} = 500mA$ to $1.5A$, $V_{OUT} = 1V$ to $4V^{(6)}$	184	230	276	V
Current-Limit Response Time	$V_{OUT} = 0V^{(5)(6)}$		25		μs

Output Response Times

Output Turn-On Delay	$R_L = 10\Omega$, $C_L = 1\mu F$, Figures 1a, 1b	1	2	5	ms
Output Turn-On Rise Time	$R_L = 10\Omega$, $C_L = 1\mu F$, Figures 1a, 1b	1	2	5	ms
Output Turn-Off Delay	$R_L = 10\Omega$, $C_L = 1\mu F$, Figures 1a, 1b		30		μs
Output Turn-Off Fall Time	$R_L = 10\Omega$, $C_L = 1\mu F$, Figures 1a, 1b		30		μs

Error Flag

Error Flag Output Resistance	$V_{IN} = 5V, I_L = 10\mu A$		7	15	Ω
	$V_{IN} = 3.3V, I_L = 10\mu A$		9	20	Ω
Error Flag Off Current	$V_{FLG} = 5.0V$		0.01	1	μA

Thermal Protection

Over-temperature Shutdown	T_J Rising		150		$^{\circ}C$
Over-temperature Shutdown Hysteresis			5		$^{\circ}C$

Notes:

1. Exceeding the absolute maximum rating may damage the device.
2. The device is not guaranteed to function outside its operating rating.
3. Devices are ESD sensitive. Handling precautions recommended. Human body model, 1.5k in series with 100pF.
4. Off is $\leq 0.8V$ and on is $\geq 2.4V$ for the MIC2544A-1 and MIC2548A-1. Off is $\geq 2.4V$ and on is $\leq 0.8V$ for the MIC2544A-2 and MIC2548A-2. The enable input has about 200mV of hysteresis.
5. Guaranteed by design but not production tested.
6. Current limit threshold is determined by $I_{LIMIT} = \frac{230V}{R_{SET}}$, where R_{SET} is in ohms.

Test Circuit

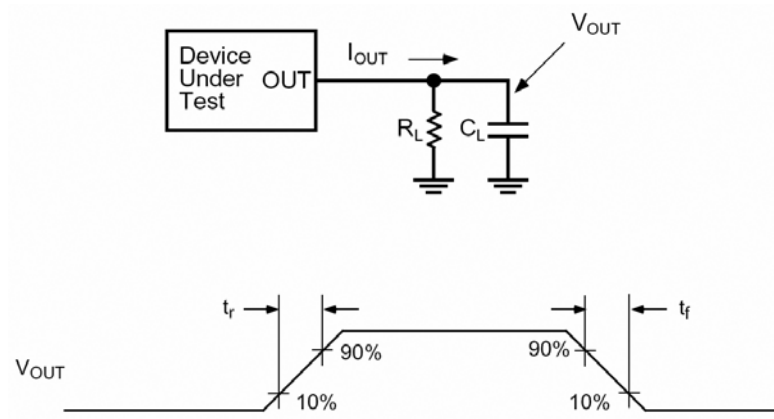

Functional Characteristics Test Circuit

Timing Diagrams

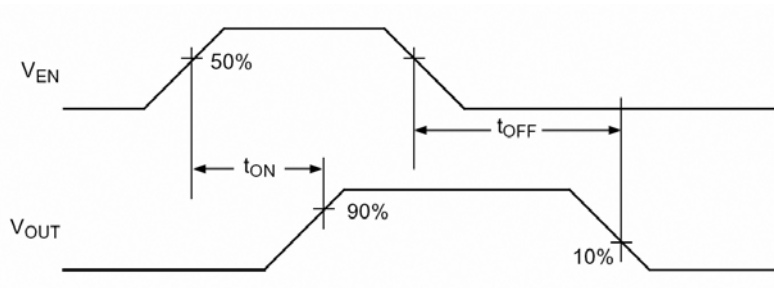

Figure 1a. MIC2544A-1/MIC2548A-1

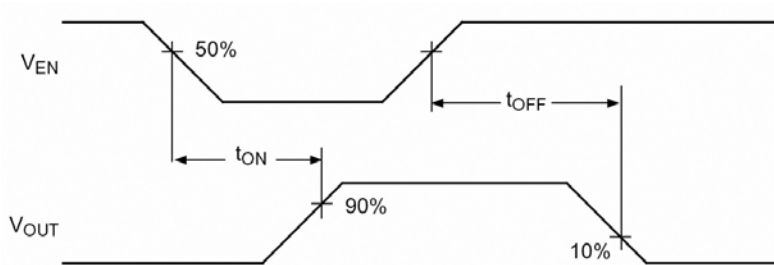

Figure 1b. MIC2544A-2/MIC2548A-2

Timing Diagrams (Continued)

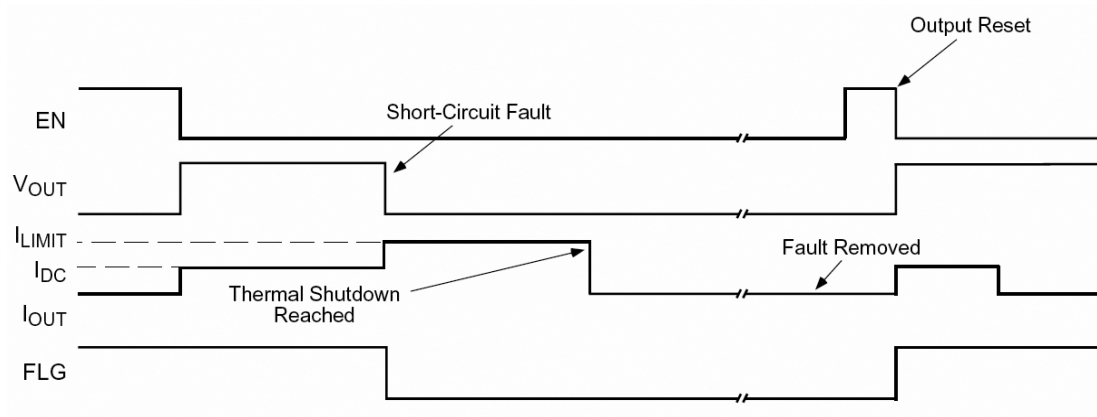

Figure 2a. MIC2548A-2 Timing: Output is reset by toggling EN

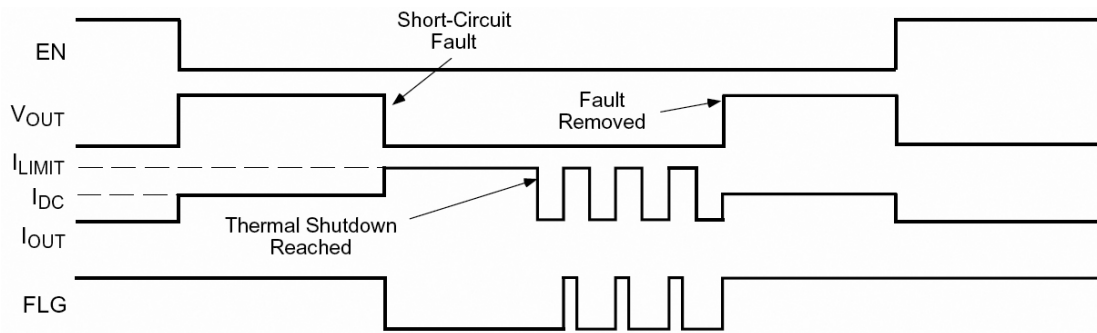
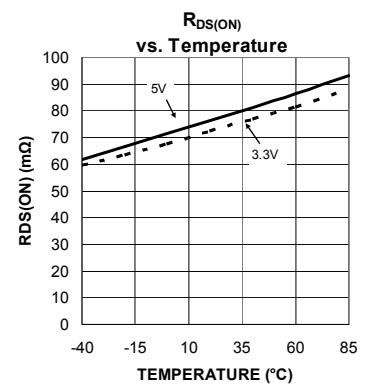
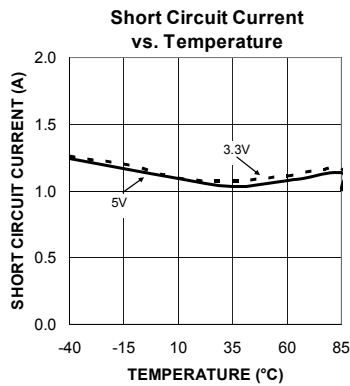
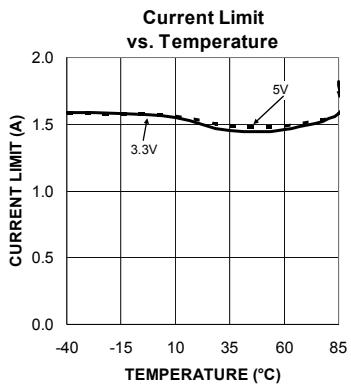
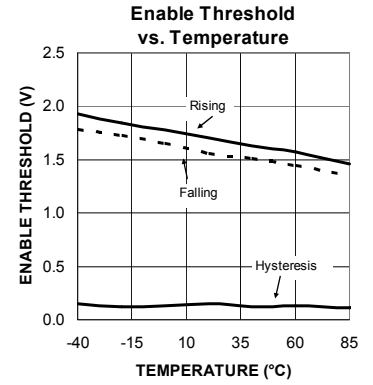
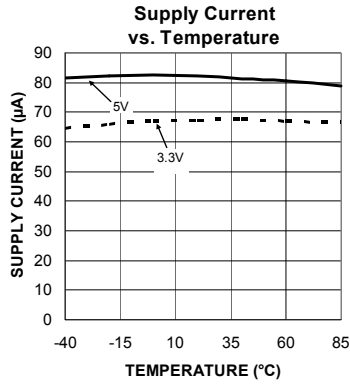
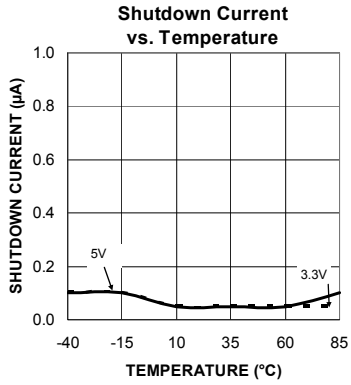
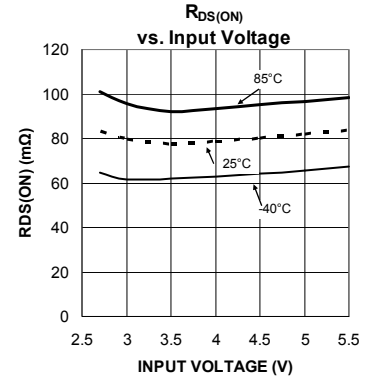
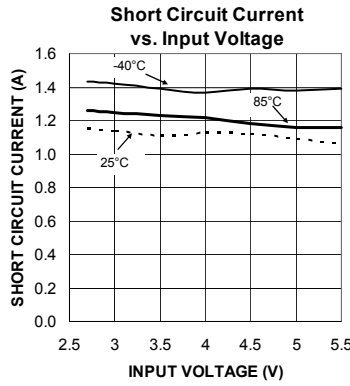
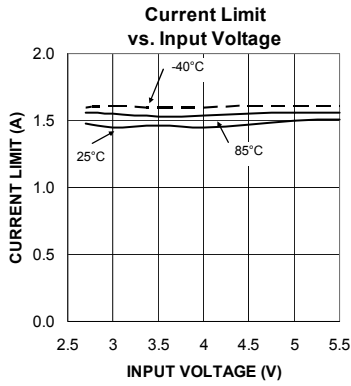
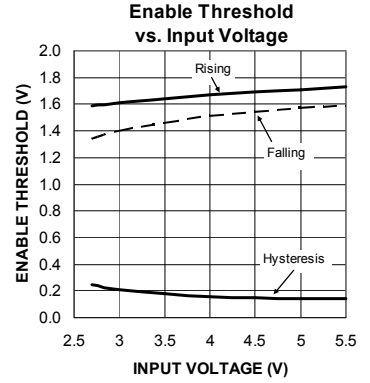
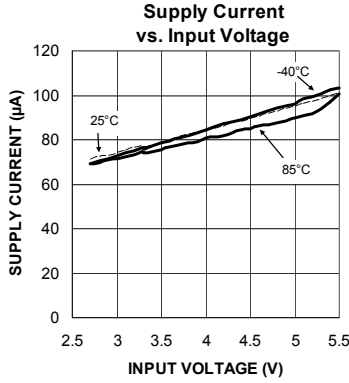
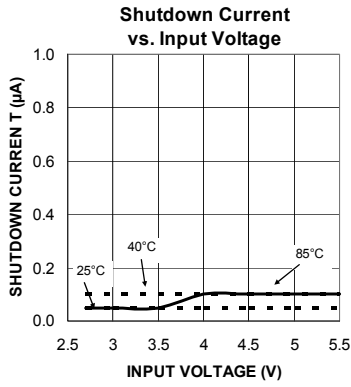
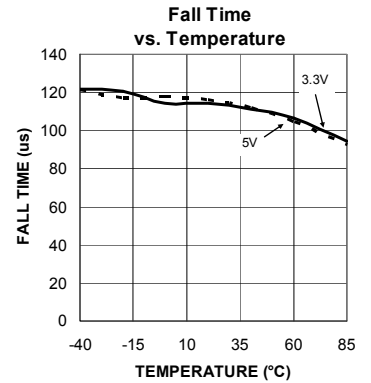
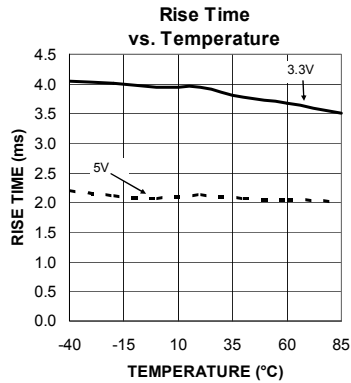
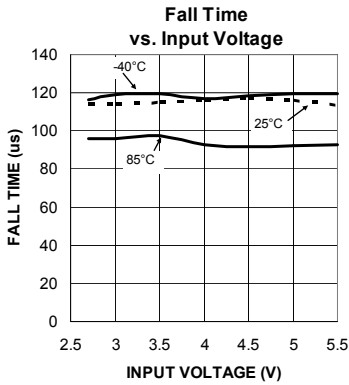
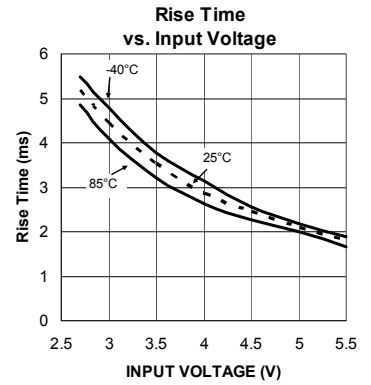
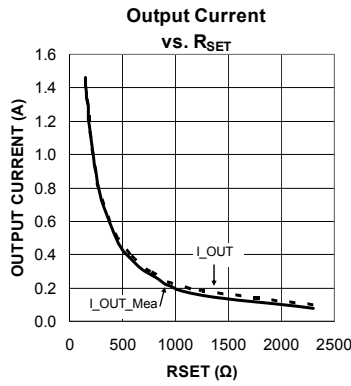
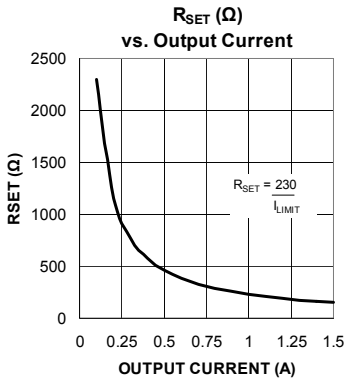
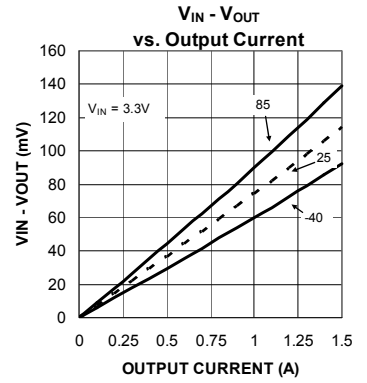
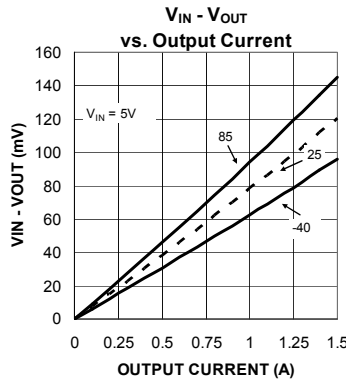
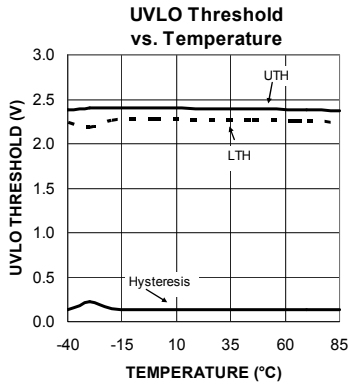

Figure 2b. MIC2544A-2 Timing

Typical Characteristics



Typical Characteristics (Continued)



Functional Characteristics

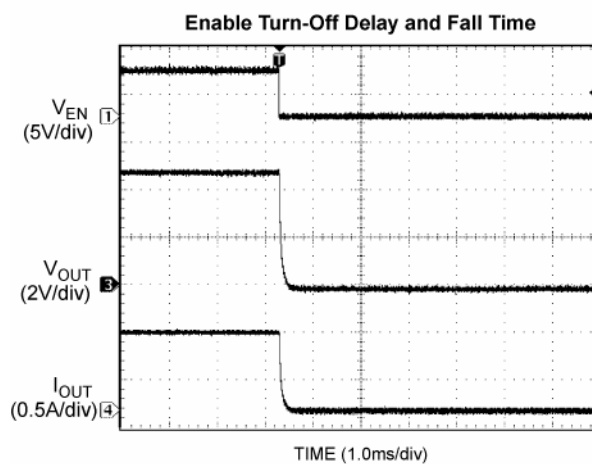
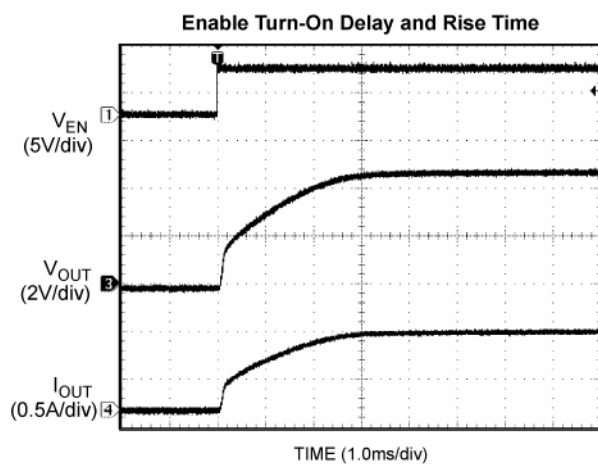
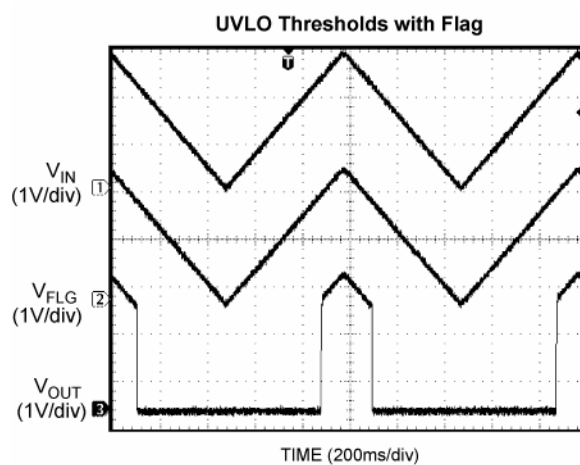
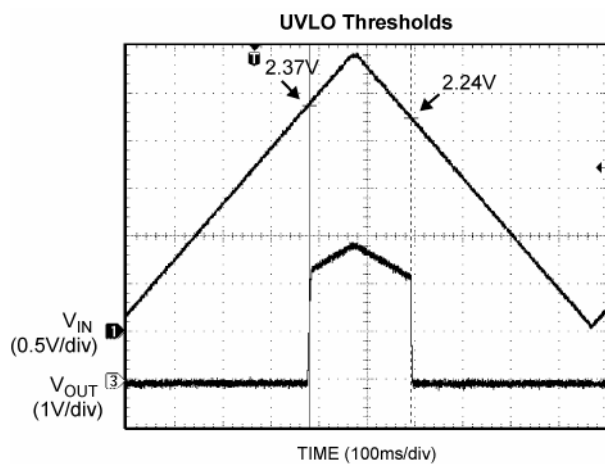
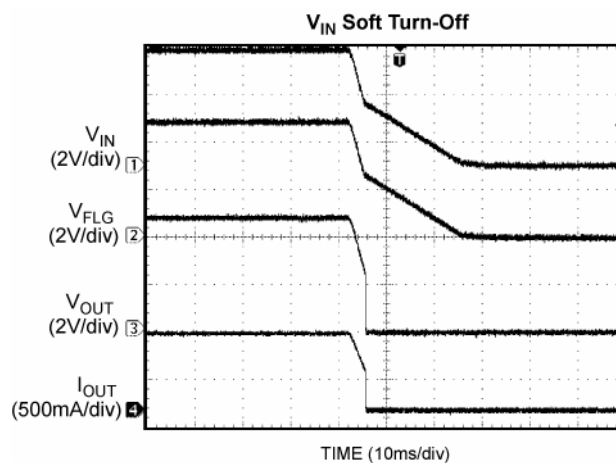
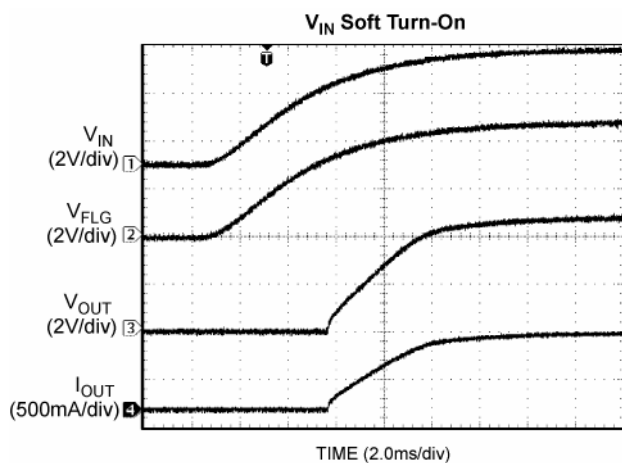

Note:

The following applies unless otherwise noted: MIC2544A-1, T_A = 25°C, V_{IN} = 5.0V, R_{SET} = 232Ω, C_{OUT} = 10μF.

Functional Characteristics (Continued)

Enable Turn-On/Turn-Off

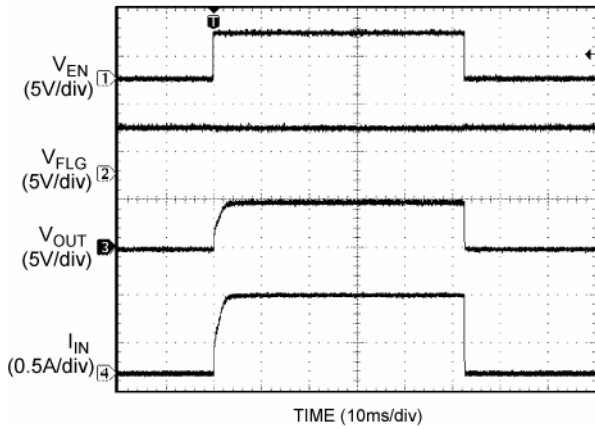

EnableThresholds

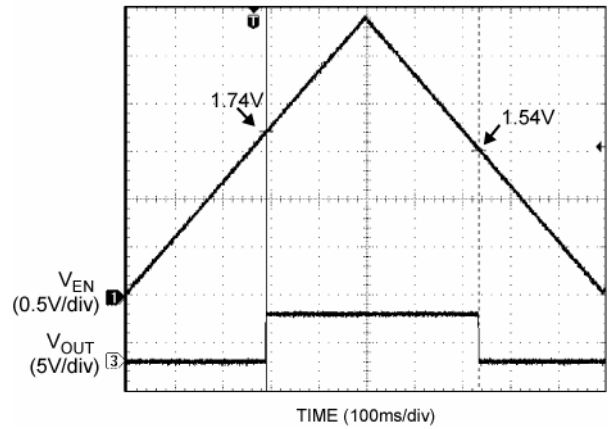

V_{IN} Soft Turn-On Inrush Current Response

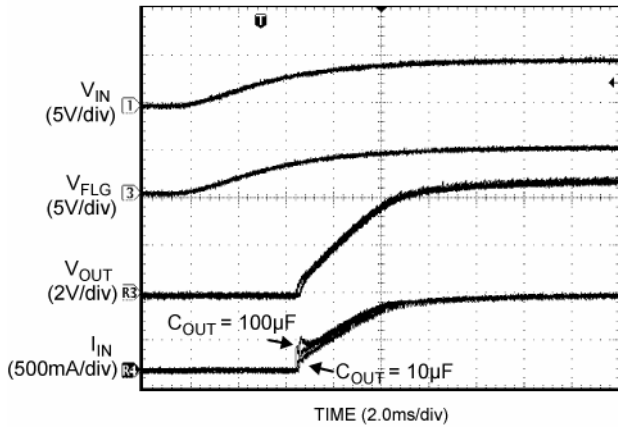

Inrush Current Response

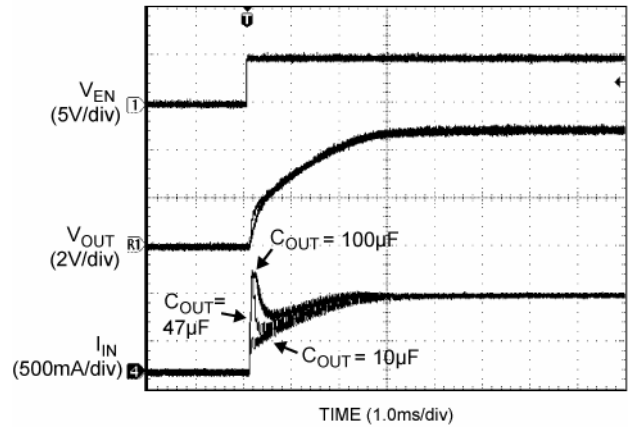

Inrush Current Response with 470 μF

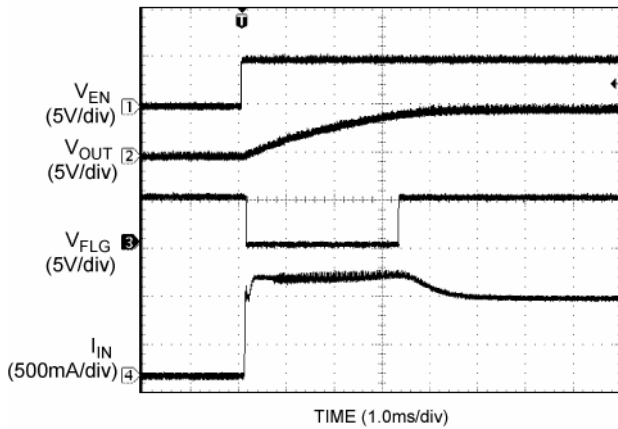

Output VI Curve

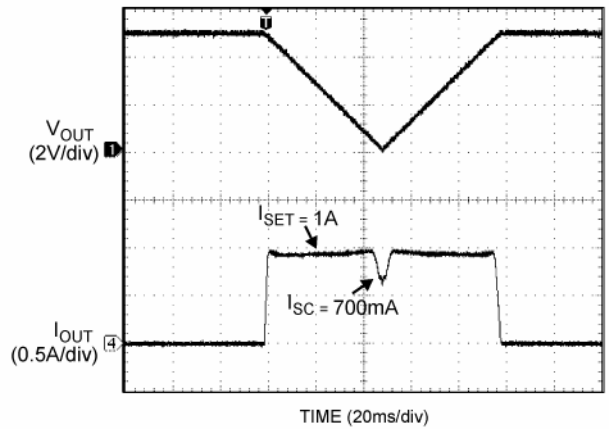

Functional Characteristics (Continued)

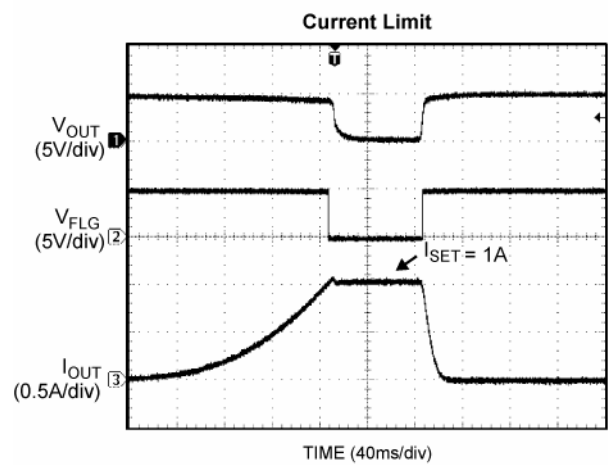
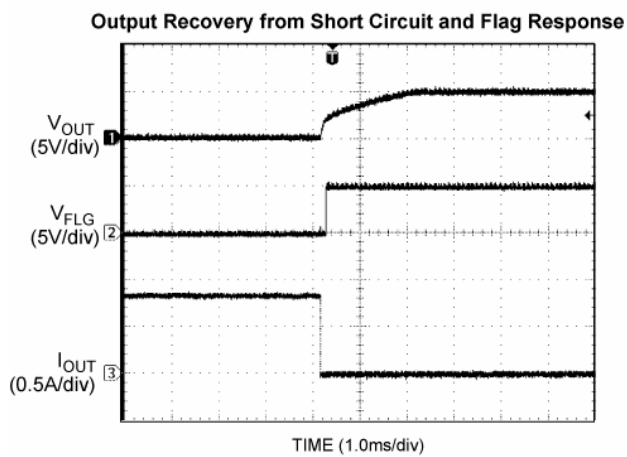
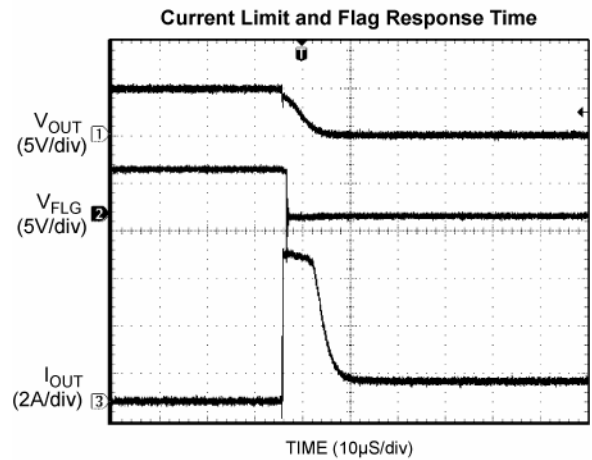
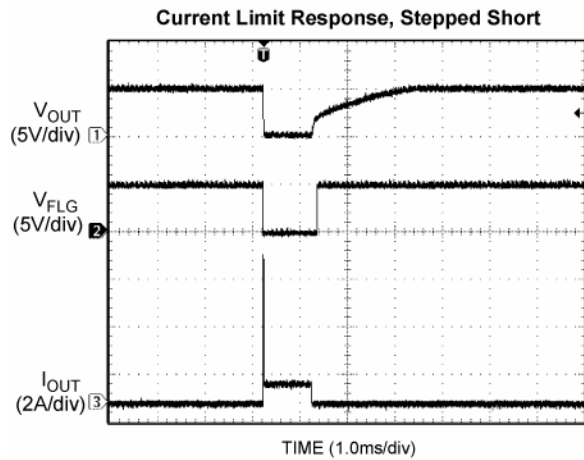
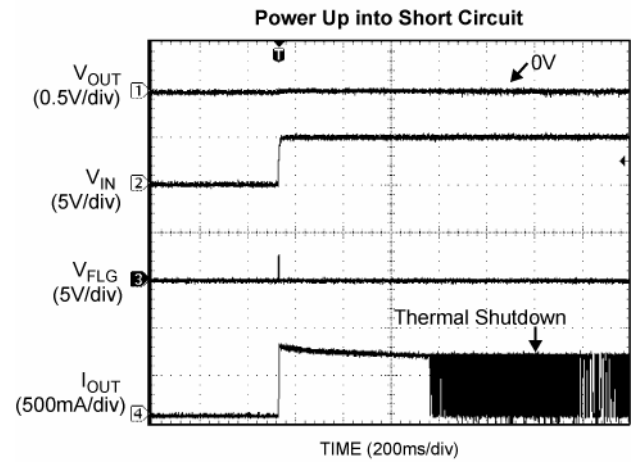
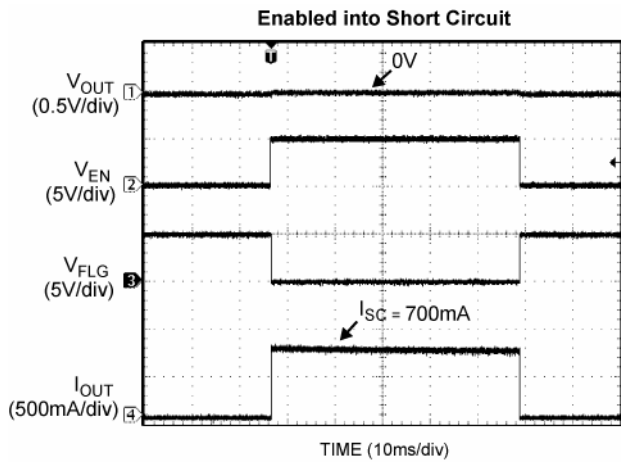

Functional Characteristics (Continued)

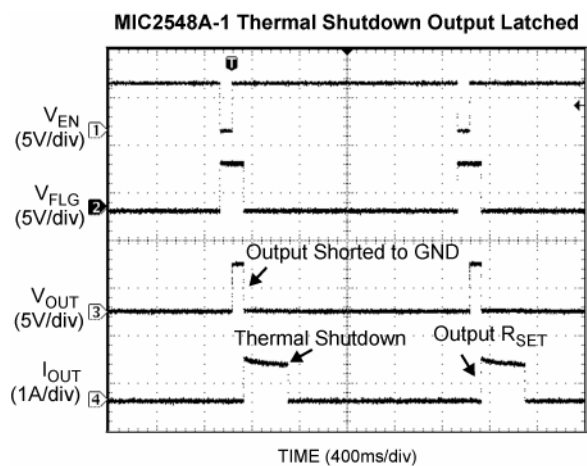
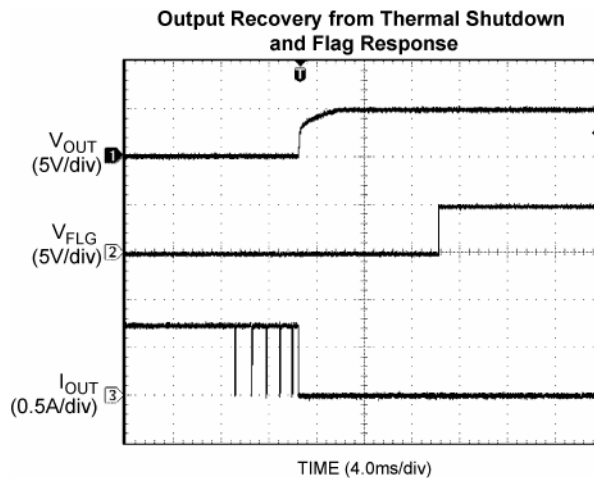
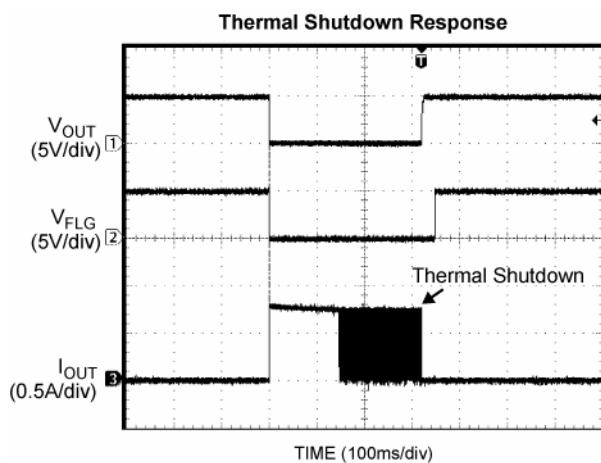

Block Diagram

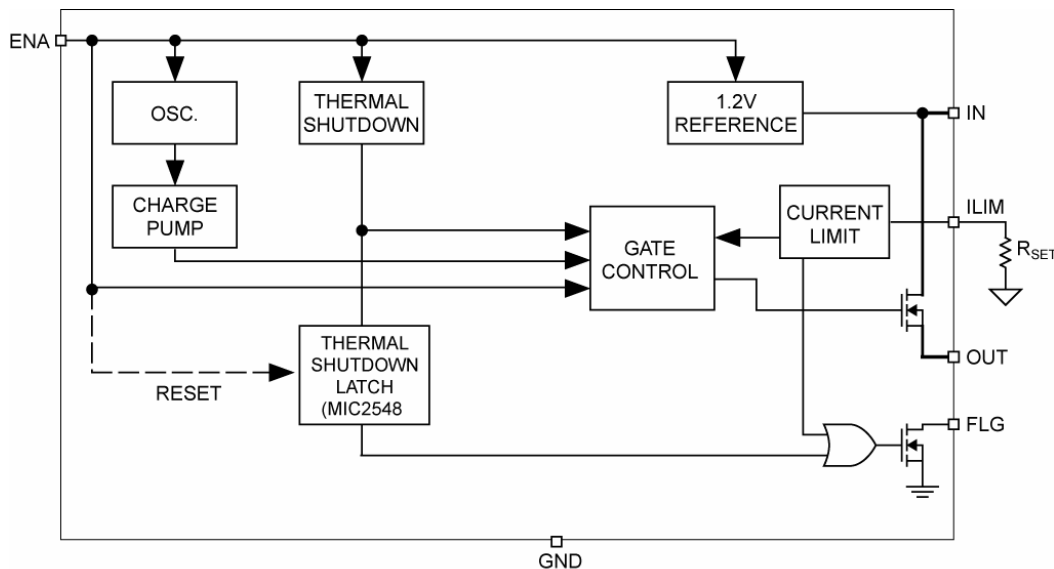

Functional Description

The MIC2544A and MIC2548A are high-side N-channel switches available with either active-high or active-low enable inputs. Fault conditions turn-off or inhibit turn-on of the output transistor and activate the open-drain error flag transistor making it sink current-to-ground.

Input and Output

IN is the power supply connection to the logic circuitry and the drain of the output MOSFET. OUT is the source of the output MOSFET. In a typical circuit, current flows from IN to OUT toward the load. If V_{OUT} is greater than V_{IN} , current will flow from OUT to IN since the switch is bidirectional when enabled.

The output MOSFET and driver circuitry are also designed to allow the MOSFET source to be externally forced to a higher voltage than the drain ($V_{OUT} > V_{IN}$) when the switch is disabled. In this situation, the MIC2544A/48A avoids undesirable current flow from OUT to IN. Both OUT pins must be connected together.

Thermal Shutdown

Thermal shutdown shuts off the output MOSFET and signals the fault flag if the die temperature exceeds 150°C. 5°C of hysteresis prevents the switch from turning on until the die temperature drops to 145°C. Over-temperature detection functions only when the

switch is enabled.

The MIC2548A features an internal latch which causes the part to remain off after thermal shutdown until a reset pulse is provided via the enable pin (pin 1). While in current-limit, the thermal shutdown latch prevents on/off cycling of the output.

Refer to Figures 2a and 2b for timing diagram. The flag remains low until reset.

Enable Input

EN must be driven logic high or logic low, or be pulled high or low for a clearly defined input. Floating the input may cause unpredictable operation. EN should not be allowed to go negative with respect to GND, and V_{EN} should be less than or equal to V_{IN} .

Setting I_{LIMIT}

The MIC2544A/2548A's current limit is user programmable and controlled by a resistor connected between the I_{LIMIT} pin and ground. The value of this resistor is determined by the following equation:

$$I_{LIMIT} = \frac{\text{CurrentLimitFactor}(CLF)}{R_{SET}}$$

or

$$R_{SET} = \frac{\text{CurrentLimitFactor}(V)}{I_{LIMIT} (A)}$$

For example: Set $I_{LIMIT} = 1.0A$

Looking in the Electrical specifications we will find CLF at $I_{LIMIT} = 1 A$.

Min	Typ	Max	Units
184	230	276	V

Table 1. CLF at $I_{LIMIT} = 1A$

For the sake of this example, we will say the typical value of CLF at an I_{OUT} of 1A is 230V. Applying the equation above:

$$R_{SET}(\Omega) = \frac{230V}{1.0A} = 230\Omega$$

$$R_{SET} = 232\Omega$$

(the closest standard 1% value)

Designers should be aware that variations in the measured I_{LIMIT} for a given R_{SET} resistor, will occur because of small differences between individual ICs (inherent in silicon processing) resulting in a spread of I_{LIMIT} values. In the example above a typical value of CLF was used to calculate R_{SET} . One can determine I_{LIMIT} 's spread by using the minimum and maximum values of CLF and the calculated value of R_{SET} .

$$I_{LIMIT_MIN} = \frac{184V}{232\Omega} = 0.79A$$

$$I_{LIMIT_MAX} = \frac{276V}{232\Omega} = 1.19A$$

Giving one a maximum I_{LIMIT} variation over-temperature of:

I_{LIMIT_MIN}	I_{LIMIT_TYP}	I_{LIMIT_MAX}
0.79A (-21%)	1.0A	1.19A (+19%)

I_{OUT}	R_{SET}	I_{OUT_Min}	I_{OUT_Max}
0.2	1150	0.140	0.260
0.3	767	0.210	0.390
0.4	575	0.280	0.520
0.5	460	0.350	0.650
0.6	383	0.480	0.720
0.7	329	0.560	0.840
0.8	288	0.640	0.960
0.9	256	0.720	1.080
1	230	0.800	1.200
1.1	209	0.880	1.320
1.2	192	0.960	1.440
1.3	177	1.040	1.560
1.4	164	1.120	1.680
1.5	153	1.200	1.800

Table 2. MIC2544A/2548A R_{SET} Table

Short-Circuit Protection

In the event of a short circuit, the output current will fold back to approximately 70% of the short-circuit current-limit.

Fault Flag

FLG is an N-channel, open-drain MOSFET output. The fault flag is active (low) for current-limit or thermal shutdown conditions. The flag output MOSFET is capable of sinking a 10mA load to typically 100mV above ground. The FLG response delay time t_D is typically 5 μ s.

Application Information

Supply Filtering

A minimum 1µF bypass capacitor from IN-to-GND, located near the MIC2544A and MIC2548A, is strongly recommended to control supply transients. Without a bypass capacitor, an output short may cause sufficient ringing on the input (from supply lead inductance) to damage internal control circuitry. An additional 22µF input capacitor placed close to the IC is required if a bulk input capacitor is further than 3 inches away from the IC.

Input transients **must not exceed** the absolute maximum supply voltage ($V_{IN\ max} = 6V$) even for a short duration.

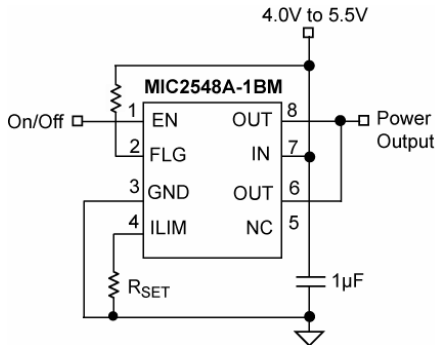

Figure 3. Supply Bypassing

Power Dissipation

The device's junction temperature depends upon several factors such as the load, PCB layout, ambient temperature, and package type. Equations that can be used to calculate power dissipation and junction temperature are found below.

Calculation of power dissipation can be accomplished by the following equation:

$$P_D = R_{DS(on)} \times (I_{OUT})^2$$

To relate this to junction temperature, the following equation can be used:

$$T_j = P_D \times \theta_{JA} + T_A$$

where:

T_j = junction temperature

T_A = ambient temperature

θ_{JA} = is the thermal resistance of the package

Transient Over Current Filter

The inrush current from the connection of a heavy capacitive load may cause the fault flag to fall for 10µs to 200µs while the switch is in a constant-current mode, charging the capacitance, as shown in Figure 4.

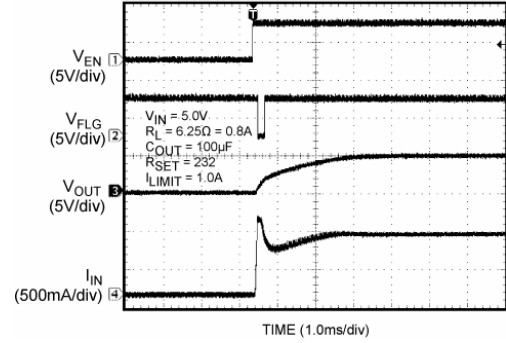

Figure 4. Flag Glitch with $C_{OUT} = 120\mu F$

Adding an optional series resistor-capacitor (R_{SET2}), in parallel with R_{SET} , and as shown in Figure 8, allows the transient current-limit to be set to a different value than steady-state. A typical USB hot-plug inrush is 2A to 3A for 10µs to 20µs. If R_{SET} is 309Ω (525mA), an R_{SET2} of 100Ω (2.3A) and C_{SET} of 1µF ($RC = 100\mu s$) allows transient surge of 3A to pass for 100µs without tripping the over current flag (FLG), as shown in Figure 5.

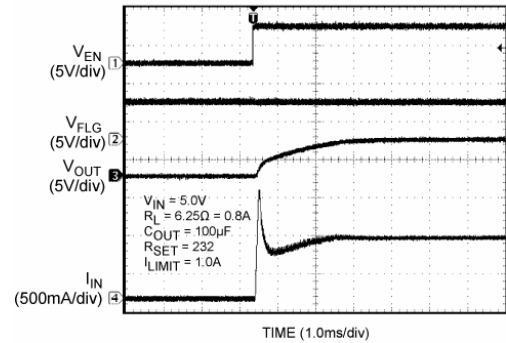

Figure 5. ILIMIT Filter with $C_{OUT} = 120\mu F$

Figure 6 circuit can also be used to filter out transient FLG assertion. The value of the RC time constant should be selected to match the length of transient. Figure 7 shows the FLAG pin waveform due to the inrush of current surge.

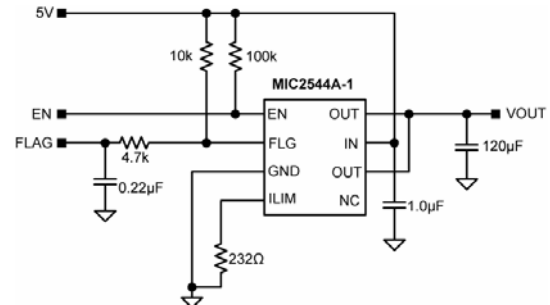

Figure 6. Flag Filter Circuit

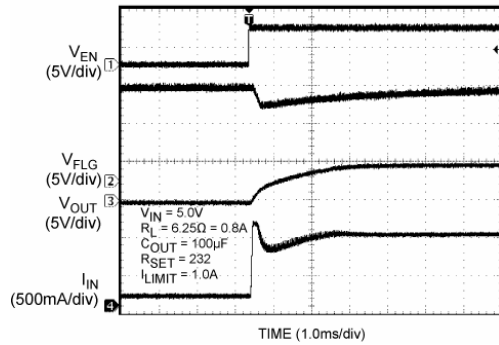

Figure 7. Flag Filter with $C_{OUT} = 100\mu F$

USB Power Distribution

The MIC2544A is ideal for meeting USB power distribution requirements. Figure 8 depicts a USB Host application. RSET should be set to a value providing a current-limit $>500mA$.

The accurate current-limit of the MIC2544A will reduce power supply current requirements. Also, fast reaction to short circuit faults prevent voltage droop in mobile PC applications.

Printed Circuit Board Hot-Plug

The MIC2544A/48A are ideal inrush current-limiters suitable for hot-plug applications. Due to the integrated charge pump, the MIC2544A/48A presents high impedance when off and slowly becomes low impedance as it turns on. This “soft start” feature effectively isolates power supplies from highly capacitive loads by reducing inrush current during hot-plug events. Figure 9 shows how the MIC2544A may be used in a hot-plug application.

Package Information

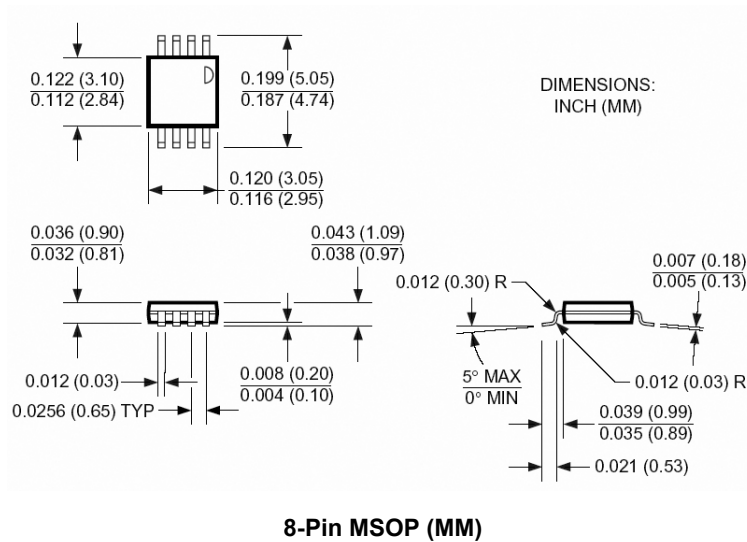
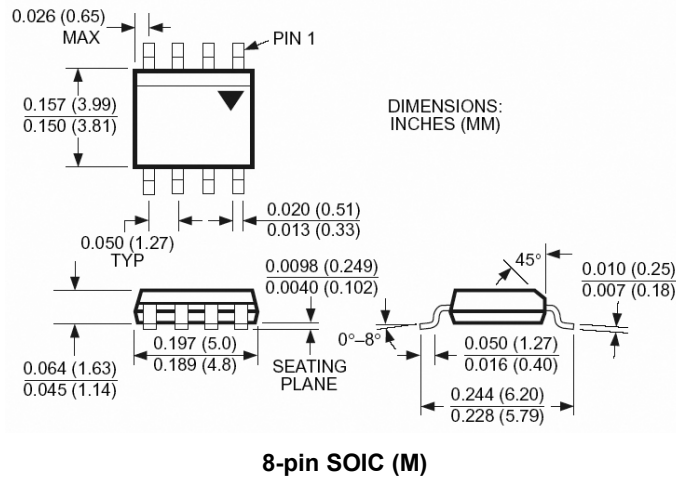

MICREL, INC. 2180 FORTUNE DRIVE SAN JOSE, CA 95131 USA
 TEL +1 (408) 944-0800 FAX +1 (408) 474-1000 WEB <http://www.micrel.com>

The information furnished by Micrel in this data sheet is believed to be accurate and reliable. However, no responsibility is assumed by Micrel for its use. Micrel reserves the right to change circuitry and specifications at any time without notification to the customer.

Micrel Products are not designed or authorized for use as components in life support appliances, devices or systems where malfunction of a product can reasonably be expected to result in personal injury. Life support devices or systems are devices or systems that (a) are intended for surgical implant into the body or (b) support or sustain life, and whose failure to perform can be reasonably expected to result in a significant injury to the user. A Purchaser's use or sale of Micrel Products for use in life support appliances, devices or systems is a Purchaser's own risk and Purchaser agrees to fully indemnify Micrel for any damages resulting from such use or sale.

© 2010 Micrel, Incorporated.