

AOYUE[®]

Replacement Air Nozzles

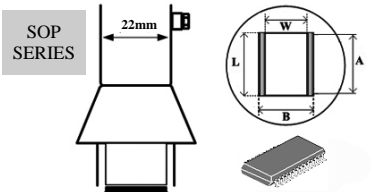
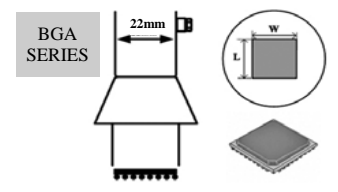

MODEL #	IC SIZE	L (mm)	W (mm)
1010	9×9mm	10	10
1313	12×12mm	13	13
1616	15×15mm	16	16
1919	18×18mm	19	19
2828N	27×27mm	28	28
3030N	29×29mm	30	30
3232W	31×31mm	32	32
3636W	36×36mm	36	36
3939W	38×38mm	39	39
4141W	40×40mm	41	41
4343W	42×42mm	43	43
4545W	44×44mm	45	45

MODEL #	IC SIZE	L (mm)	W (mm)	A (mm)	B (mm)
1131	4.4×10mm	11	3.8	9	10.3
1132	5.6×13mm	16	4.7	14	11.7
1133	7.5×15mm	17	6	15	13
1134	7.5×18mm	20	6	18	13
1257	11×21mm	22	11	20	18
1258	7.6×12.7mm	12	7	10	14
1259	13×28mm	30	12.5	28	19.5
1260	8.6×18mm	20	7.7	18	14.7

SGL SERIES

MODEL #	NOZZLE SIZE Ø
1194	6mm
1195	8mm
1196	7mm
1197	9mm
1198	12mm

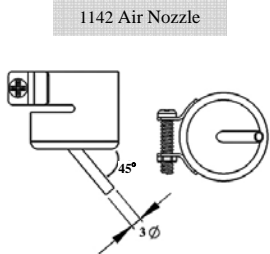
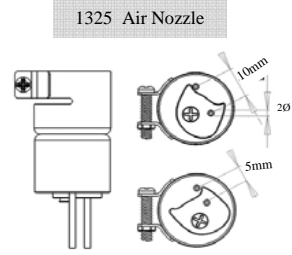

SIL SERIES

MODEL #	IC SIZE	L (mm)
1191	SIP25L	26
1192	SIP50L	52.5

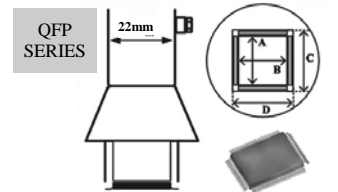

MODEL #	IC SIZE	A (mm)	B (mm)	C (mm)	D (mm)
1125	10×10mm	9	9	16	16
1126	14×14mm	14	14	21	21
1127	17.5×17.5mm	18	18	25	25
1128	14×20mm	20	14	21	27
1129	28×28mm	28	28	35	35
1215	42.5×42.5mm	41	41	48	48
1261	20×20mm	19	19	26	26
1262	12×12mm	11	11	18	18
1263	28×40mm	38	28	35	45
1264	40×40mm	39	39	46	46
1265	32×32mm	31	31	38	38

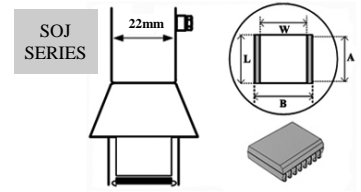

MODEL #	IC SIZE	L (mm)	W (mm)	A (mm)	B (mm)
1183	15×8mm	17	7	15	14
1184	18×8mm	20	9	18	16
1214	10×26mm	27	11	25	18

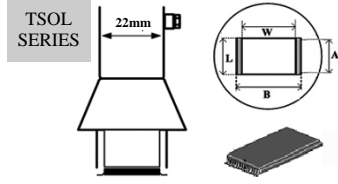

MODEL #	IC SIZE	L (mm)	W (mm)	A (mm)	B (mm)
1185	13×10mm	11	11	9	18
1186	18×10mm	12	17	10	24
1187	18.5×8mm	11	18	9	25

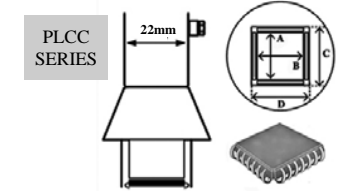

MODEL #	IC SIZE	A (mm)	B (mm)	C (mm)	D (mm)
1135	17.5×17.5mm	17.5	17.5	24.5	24.5
1136	20×20mm	20	20	27	27
1137	25×25mm	25	25	32	32
1138	30×30mm	30	30	37	37
1139	7.3×12.5mm	7.5	12.5	14.5	19.5
1140	11.5×11.5mm	12	12	19	19
1141	11.5×14mm	12	14	19	21
1188	9×9mm	10	10	17	17
1189	34×34mm	35.5	35.5	42.5	42.5

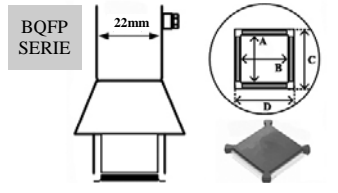

MODEL #	IC SIZE	L (mm)	W (mm)	A (mm)	B (mm)
1180	17×17mm	17.2	17.2	24.2	24.2
1181	19×19mm	18.2	18.2	25.2	25.2
1182	24×24mm	23.2	23.2	30.2	30.2
1203	35×35mm	34.2	34.2	41.2	41.2

AOYUE[®]

888A

(Centigrade / Fahrenheit switchable)

Repairing System

INSTRUCTION MANUAL

Thank you for purchasing Aoyue 888A Repairing System. It is important to read the manual before using the equipment. Please keep manual in accessible place for future reference.



This manual is designed to familiarize and instruct the operator with the proper usage and maintenance of the equipment. The "Care and Safety Precautions" section explains the hazards of using any type of soldering or reworking device. Please read carefully and observe the guidelines in order to maximize usage and minimize the risk of injury or accidents .

TABLE OF CONTENTS

Product Description	3
Specifications	3
Package Inclusion	4
Functions and Features	4
Safety Precautions	5
Control Panel Guide	6
Assembly and Preparation	7
Operating Guidelines	8-11
Auto-Sleep Functions	12
Temperature Scale	13
Air Flow Calibration	14
Digital Calibration	15
Line Frequency	16
Care and Maintenance	17
Basic Troubleshooting Guide	18
Soldering Tips	19
Air Nozzles	20

Manufacturer:

AOYUE INTERNATIONAL LIMITED
 Jishui Industrial Zone, Nantou, Zhongshan City,
 Guangdong Province, P.R.China
<http://www.aoyue.com>

REPLACEMENT TIPS

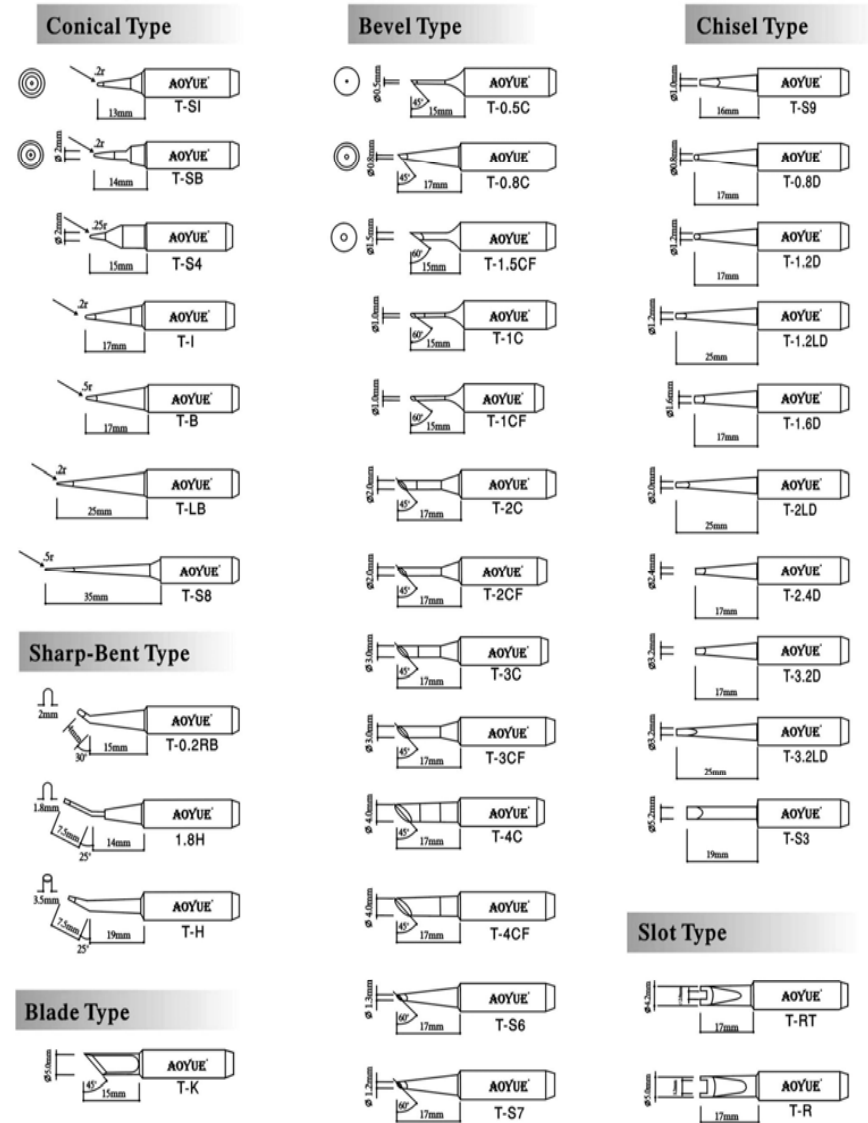

Note: The above items are sold separately.

BASIC TROUBLESHOOTING GUIDE

PROBLEM 1: THE UNIT HAS NO POWER

1. Check if the unit is switched ON.
2. Check the fuse. Replace with the same type if fuse is blown.
3. Check the power cord and make sure there are no disconnections.
4. Verify that the unit is properly connected to the power source.

PROBLEM 2: HOT-AIR GUN TEMPERATURE DISPLAY IS ALWAYS ABOVE 500°C

Description: Constant display of above 500°C temperature from the panel then displays an "Err1" on the panel after a few minutes.

SOLUTION:

The thermal sensor may be broken and needs to be replaced.

PROBLEM 3: HOT-AIR GUN ACTUAL AIR TEMPERATURE IS NOT INCREASING

Description: Actual temperature reading is not increasing based on desired level.

SOLUTION:

The heating element may be broken or is at the end of its life and needs to be replaced.

PROBLEM 4: THE UNIT IS VIBRATING TOO MUCH

SOLUTION: Check if the 4 pump holder are properly and tightly connected. Unplug the system from the main power source before opening the case to check inside the station.

PROBLEM 5: THE UNIT IS VERY NOISY

SOLUTION:

Make sure the screw at the center of the base of the main unit has been removed. This holds the pump in place during transportation and needs to be removed before using the equipment.

PROBLEM 6: SOLDERING IRON TEMPERATURE DISPLAY PANEL SHOWS "Err1" CHARACTERS

Case 1: The system shows "Err1" from the soldering iron temperature display panel .

SOLUTION 1: Check if the soldering iron connection assembly is properly connected and secured to the receptacle on the control panel.

SOLUTION 2: Switch OFF the device and switch ON again.

PROBLEM 7: UNIT SHOWS UNCONVENTIONAL BEHAVIOR

Description: Unit operates erratically.

SOLUTION: Try to switch OFF the device and switch ON again.

OTHER PROBLEMS NOT MENTIONED:

Contact the vendor.

PRODUCT DESCRIPTION

The Aoyue 888A SMD Repairing System is a reworking equipment that combines the functionality of Hot Air Gun and a lead free compatible Soldering Iron in one package.

It has several safety features such as the auto-cooling process of the Hot Air Gun. This functionality protects the device (and its components) from excessive heat by blowing air at maximum flow to rapidly cool down the temperature of the heating element. It has several advanced features such as Centigrade and Fahrenheit selection, hot air gun / solder iron digital calibration, configurable auto sleep for hot-air and soldering iron. Finally, the unique, innovative design with digital control panel and display provides precision, safety, and ease of use to match all reworking requirements.

SPECIFICATION

MAIN STATION	
Power Input :	available in 110V / 220V
Station Dimensions:	188(w) x 126(h) x 250(d) mm
Weight:	5.6Kg
SOLDERING IRON	
Power Consumption:	60W
Temperature Range:	200°C - 480°C
Heating Element:	Ceramic Heater
Output Voltage:	24V
HOT AIR GUN	
Power Consumption:	500W
Temperature Range:	100°C - 480°C
Heating Element	Metal Heating Core
Motor Type:	888A Sirocco Fan

Specifications are subject to change without prior notice.

PACKAGE INCLUSIONS

1 unit	Main Station with Hot Air Gun and Holder.
1pc.	1194 Air Nozzle
1pc.	1195 Air Nozzle
1pc.	1198 Air Nozzle
1pc.	B016 Soldering Iron
1pc.	Spring Iron Holder
1pc.	G001 IC Popper
1pc.	Spool Holder
1pc.	Sponge Tray
1pc.	User Manual

* Type of soldering tip included might change depending on availability.

** Kindly refer to soldering iron stand installation insert for parts and instructions.

FUNCTION and FEATURES

- Microprocessor-controlled ESD safe equipment.
- 2-in-1 repairing system combining Hot Air Gun and Soldering Iron, in one sophisticated package.
- Digital feedback control and display of hot air temperature, soldering iron temperature and air pressure with knob type controls for ease of use.
- Switchable temperature readout between Fahrenheit and Centigrade.
- User configurable sleep mode for additional device protection and power savings.
- Hot air gun and soldering iron with digital calibration function.
- Built-in auto-cooling process that protects the system and its components from excessive heat, prolonging usage life.
- Compatibility with air nozzles of various types.
- Compatibility with different kind of soldering tips.

CARE and MAINTENANCE

Soldering Iron Error Messages

When soldering iron connection assembly is not connected or not properly connected to the receptacle on the control panel or when soldering iron tip is damaged and needs to be replaced. The device will display "Err 1". indicating a problem with the contacts of the soldering iron or the tip.

This appliance can be used by children aged from 8 years and above and persons with reduced physical, sensory or mental capabilities or lack of experience and knowledge if they have been given supervision or instruction concerning use of the appliance in a safe way and understand the hazards involved. Children shall not play with the appliance. Cleaning and user maintenance shall not be made by children without supervision.

A fire may result if the appliance is not used with care, therefore:

- be careful when using the appliance in places where there are combustible materials ;
- do not apply to the same place for a long time;
- do not use in presence of an explosive atmosphere;
- be aware that heat may be conducted to combustible materials that are out of sight;
- place the appliance on its stand after use and allow it to cool down before storage;
- do not leave the appliance unattended when it is switched on.

Correct Disposal of this product



This marking indicates that this product should not be disposed with other household wastes throughout the EU. To prevent possible harm to the environment or human health from uncontrolled waste disposal, recycle it responsibly to promote the sustainable reuse of material resources. To return your used device, please use the return and collection systems or contact the retailer where the product was purchased. They can take this product for environmental safe recycling.

LINE FREQUENCY SELECTION

N. Line Frequency Selection

By default, the system's line frequency has been programmed from the factory but for some cases when a manual override of the line frequency is needed the following procedure can be done.

1. Follow **System Setting** procedures 1 to 6. Adjust system selection menu to Set 007, then turn the hot air gun set temperature knob to off position.
2. If successful the display "B1" "-60-" indicating frequency is being set.
3. Adjust the frequency adjustment knob "B3" to enter desired frequency value, Value is switchable between 60 or 50 Hz.
4. Save the selected calibration settings and exit from the calibration adjustment menu by turning the soldering iron set temperature knob to off position.

CARE and MAINTENANCE

Soldering Iron Tip

Always keep the solder-plated section of the tip/nozzle coated with a small amount of solder. Oxide coating on the tip of the nozzle reduces its heat conductivity. Coating the tip with a small amount of fresh solder ensures maximum heat conductivity is obtained.

Replacing the heating element of the Hot Air Gun

The heating element is found in the middle part of the hot air gun. The normal life of a heating element is 1 year under normal operating conditions.

Steps:

1. Loosen the 3 screws that secure the handle.
2. Slide off the plastic tube.
3. Disconnect the ground wire sleeve.
4. Inside the pipe, the quartz glass and heat insulation are installed. Loosen the cable and take out the heating element.
5. Insert new heating element and reconnect the terminal. *Be careful not to rub Heating Element wire.*
6. Reconnect the ground wire after replacing the element.
7. Assemble the handle again.

SAFETY PRECAUTIONS



CAUTION: Improper usage can cause serious injury to personnel and/or damage to equipment. For your own safety, please observe the ff. precautions.

- Check each component after opening the package to make sure everything is in good condition. If there are any suspected damage, do not use the item and report the issue to your vendor.
- Turn OFF the main power switch and unplug the device when moving the device from one location to another.
- Do not strike or subject the main unit to physical shock. Use carefully to avoid injury and damage to any part.
- Handle with care.
 - Never drop or sharply jolt the unit.
 - Contains delicate parts that may break if the unit is dropped.
- Make sure the equipment is always grounded. Always connect power to a grounded receptacle.
- Temperature may reach as high as 480°C when switched ON.
 - Do not use the device near flammable gases, paper and other flammable materials.
 - Do not touch heated parts, which can cause severe burns.
 - Do not touch metallic parts near the tip.
- Disconnect the plug from the power source if the unit will not be used for a long period.
 - Turn off power during breaks, if possible.
- Use only genuine replacement parts.
 - Turn off power and let the unit cool before replacing parts.
- The unit may produce a small amount of smoke and unusual odor during initial usage. This is normal and should not yield any negative result when reworking.
- Soldering process produces smoke — use on well ventilated place.
- Do not alter the unit, specifically the internal circuitry, in any manner.

CONTROL PANEL GUIDE

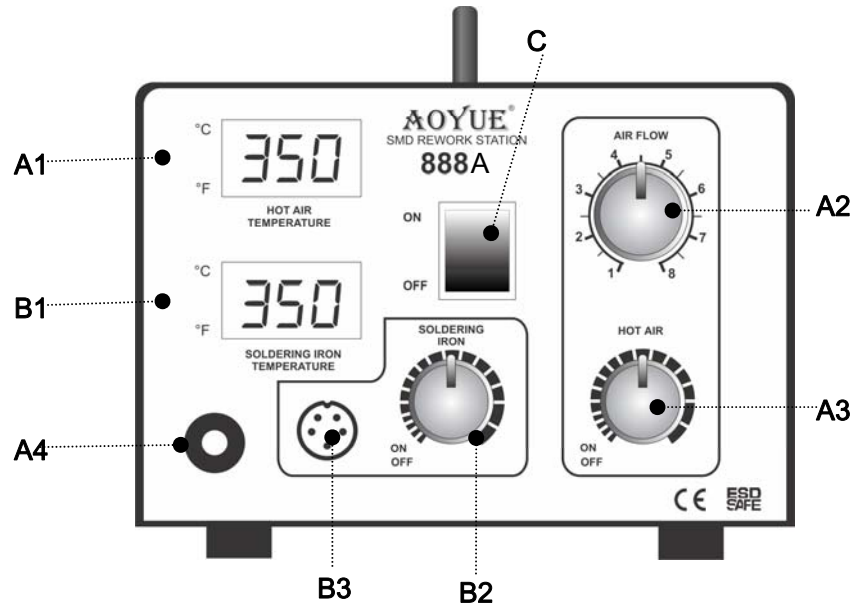

LEGEND:

- B1 — Soldering Iron Temperature Display.
- B2 — Soldering Iron Temperature Adjustment Knob with Function On/Off
- B3 — Soldering Iron 5-Pin Receptacle

- A1 — Hot Air Gun Temperature Display
- A2 — Hot Air Gun Airflow Adjustment Knob
- A3 — Hot Air Gun Temperature Adjustment Knob with Function On/Off
- A4 — Hot Air Gun Output Terminal

Back Panel

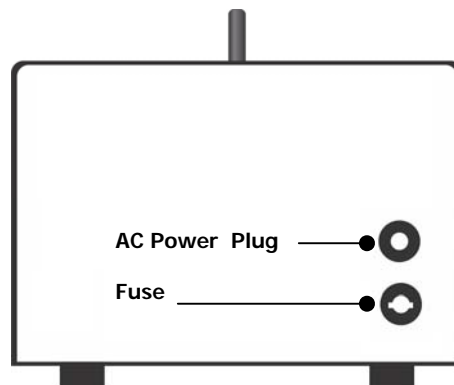

DIGITAL CALIBRATION

7. Compare the recorded actual temperature and external temperature readings. If external temperature readings is higher that the act temperature display then get the difference and enter a negative value by adjusting the air flow adjustment knob "A2", Calibration value is adjustable from -70 to 70 degrees with "000" signifying no offset.
8. Save the selected calibration settings and exit from the calibration menu by turning the soldering iron set temperature knob to off position.
9. Enter soldering iron function and set to desire temperature, check if additional calibration is needed. If additional calibration is needed repeat steps 1to 8 and each time adjusting the calibration value slightly higher or lower based on the previously entered values.

M. Utilizing the Hot Air Gun Digital Temperature Calibration

By default, the system is properly calibrated but for some cases when a little adjustment of the Hot Air Gun temperature is required the following procedure can be done.

1. Follow System Setting procedures 1 to 6. Adjust system selection menu to Set 006, then turn the hot air gun set temperature knob to off position.
2. If successful the display would show " 0FSt 024" indicating hot air gun digital calibration is being set.
3. Adjust the air flow adjustment knob "A2" to enter desired offset value, Calibration value is adjustable from -70 to 70 degrees with "000" signifying no offset.
4. Save the selected calibration settings and exit from the calibration adjustment menu by turning the soldering iron set temperature knob to off position.
5. Enter hot air gun function and set to desire temperature to check if additional calibration is needed.

AIR FLOW CALIBRATION

4. If the lowest airflow is deemed too low adjust airflow calibration value to any value above 8.
5. If the lowest airflow is deemed too high adjust airflow calibration value to any value below 8.
6. Save the selected airflow calibration settings and exit from the airflow calibration adjustment menu by turning the soldering iron set temperature knob to off position.
7. Turn on the hot air gun function and adjust the air flow to see if additional air flow calibration is needed. Repeat steps 1 to 7 each time selecting a different value when additional calibration is needed.

L. Utilizing the Solder Iron Digital Temperature Calibration

By default, the system is properly calibrated but for some cases when a little adjustment of the soldering iron temperature is required the following procedure can be done.

1. Turn on the soldering iron function.
2. Set to appropriate temperature you want to calibrate. Place the tip of the soldering iron on an external temperature sensor.
3. The readings on the external temperature sensor should be more or less equal to the displayed temperature.
4. Write down the displayed actual temperature of the soldering iron and the displayed temperature readout from the external temperature sensor. If there is a large discrepancy in the temperature reading we can re-calibrate the temperature setting.
5. Follow **System Setting** procedures 1 to 6. Adjust system selection menu to Set 005, then turn the hot air gun set temperature knob to off position.
6. If successful the display would show " 0FSt 017" indicating soldering iron digital calibration is being set.

ASSEMBLY and PREPARATIONS

A. Main Station

As soon as the equipment has been removed from the package, **REMOVE THE SCREW** located at the center of the bottom of the main unit. This screw holds the pump in place during transportation.

 **WARNING:** Failure to remove the screw before using the equipment can cause damage to the system.

B. Soldering Iron

1. Connect the soldering iron cord assembly to the soldering iron output terminal .
2. Attach the sponge plate and solder spool holder (A) to the side of the unit (B).
3. Place the soldering iron to the soldering iron stand.
4. Attach soldering iron spring holder as seen.

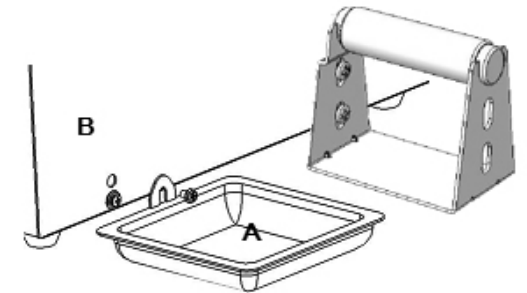

C. Hot Air Gun

The Hot Air Gun holder was installed on the station upside down for packaging purpose. To set up the Hot Air Gun holder:

1. Loosen the two screws that secure the holder to the station.
2. Turn the holder right side up.
3. Re-fasten the two screws.
4. Place the hot air gun onto the holder in preparation for usage.

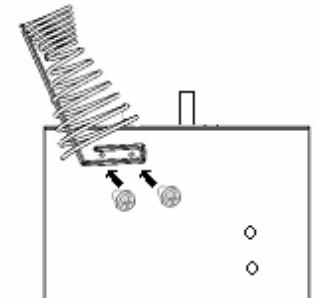

OPERATING GUIDELINES

IMPORTANT REMINDERS:

1. Make sure the equipment is placed on a flat stable surface and all the heat-generating components placed on their respective holders or stands.
2. Ensure all function switches are OFF prior to reworking.
3. Ensure all terminal connections are properly secured.

IMPORTANT: Please refer to the **CONTROL PANEL GUIDE** page for buttons and display panel directory.

D. INITIAL PROCEDURES

1. Plug the device to the main power source using the power cord provided in the package.
2. Make sure all function switches are in the off position, to do this turn soldering iron and hot air set temperature knob counter clockwise until a click is heard.
3. Make sure all terminal connections are properly secured, Power up the device by activating the main power switch.
4. The display panels, A1 and B1 will temporarily show the product name in a scrolling manner and then display "OFF" on all rows once the scroll is finished. The system will remain at this state until the user activates a function.

E. HOT AIR GUN

1. Follow the initial procedures above, "**A. INITIAL PROCEDURES**".
2. To activate the Hot air gun function turn the Hot Air gun set temperature knob clockwise until a click is heard.
3. The system will immediately start to blow air and increase the air temperature according to the set values of knob A2 for airflow and knob A3 for set temperature. The set temperature values will be reflected from the Hot Air Gun Air Temperature display A1.

TEMPERATURE SCALE

J. Selecting the Temperature Scale

The displayed temperature can be toggled between the Centigrade scale or the Fahrenheit scale.

To switch between the two scales follow these procedures:

1. Follow **System Setting** procedures 1 to 6. Adjust system selection menu to Set 003, then turn the hot air gun set temperature knob to off position.
2. If successful the display would show "Set C " indicating system scale setting is being set.
3. Select the system temperature scale with the air flow adjustment knob "A2" . Select "C" for Celsius scale and select "F" for Fahrenheit scale.
4. Save the selected temperature scale settings and exit from the temperature scale adjustment menu by turning the soldering iron set temperature knob to off position.
5. The entire system's temperature scale will change to the selected temperature scale. Selection is saved into system memory.

K. Calibrating the Airflow

If the airflow is deemed too low or airflow pressure is too high due to different line voltages. The airflow calibration can be digitally adjusted to compensate for different line voltages.

To calibrate the airflow follow these procedures:

1. Follow **System Setting** procedures 1 to 6. Adjust system selection menu to Set 004, then turn the hot air gun set temperature knob to off position.
2. If successful the display would show "Air 008 " indicating air flow calibration is being set.
3. Select the airflow calibration with the air flow adjustment knob "A2" .

AUTO SLEEP FUNCTIONS

8. Turn the soldering iron temperature adjustment knob, to wake the soldering iron from its sleep mode

I. Activating Hot Air Gun Auto-Sleep Mode

The hot air gun's SLEEP mode can be activated by following the set of procedures below:

1. Follow **System Setting** procedures 1 to 6.
2. Adjust system selection menu to Set 002, then turn the hot air gun knob to off position .
3. If successful the display "A1" would show "####" indicating hot air gun sleep timer setting is being set.
4. Adjust the sleep timer with the air flow adjustment knob "A2", Sleep timer is adjustable from 1 to 60 minutes with "OFF" signifying sleep timer is turned off.
5. Save the selected timer settings and exit from the sleep timer adjustment menu by turning the soldering iron function temperature knob to off position.
6. If the sleep mode is activated the sleep timer will start counting down once the hot air gun function is activated.
7. When the sleep timer expires, the system will start cooling down the hot air gun by blowing air at maximum intensity while the display shows a flashing OFF to signify hot air gun is currently preparing to go into sleep mode. Once hot air gun actual temperature goes below 90 degrees, the display "A1" would show " - - - - " four dashes indicating hot air gun is now in sleep mode.
8. Turn the hot air gun temperature adjustment knob to wake the hot air gun from its sleep mode,

OPERATING GUIDELINES

4. Adjust the air flow level using the airflow adjustment knob ("A2" from the control panel).
5. Adjust the hot air gun air temperature using the hot air gun temperature adjustment knob ("A3" from the control panel). The display for Hot Air Gun Temperature will change from actual temperature display to set temperature display while the knob is being adjusted. When set temperature adjustment is done wait a few seconds for the display A1 to return to displaying the actual temperature.

 **IMPORTANT:** When adjusting the air temperature, it is strongly advised to initially increase the airflow level in order to manage the system temperature. This is to protect the heating element inside the handle from excessive heat and avoid the possibility of subjecting adjacent components to thermal shock.

7. Reworking task can be started 1 minute after the desired hot air temperature and airflow level are reached, as also indicated from display panel "A1" .
8. When reworking is complete, return the Hot Air Gun to its holder and **DO NOT** immediately turn off the main power switch.
9. Deactivate the Hot Air Gun by turning the Hot Air Gun set temperature knob counterclockwise until a click is heard to activate the auto-cooling process. The system will start to blow air (at room temperature) at a fast rate to reduce heat from the hot air gun and bring down the temperature to a reasonable safe level of **90°C**. During this time, the display for hot air gun temperature will also alternate from "Off" to actual temperature display. Likewise, the air pressure level is at its highest reading as indicated from the air flow gauge. Once the temperature drops to approximately **90°C** the system will halt and display "OFF" on the panel. It is now safe to switch off the main power switch.
10. Turn OFF the main power switch and unplug the device from the main power source.

OPERATING GUIDELINES

F. SOLDERING IRON

1. Connect the Soldering Iron connection assembly to the receptacle located at the front of the control panel ("B3" from the CONTROL PANEL GUIDE).
2. Follow the initial procedures ("A. INITIAL PROCEDURES").
3. To activate the "SOLDER IRON" function, turn the solder iron set temperature knob B2 clockwise until a click is heard.
3. Adjust the soldering iron temperature using the soldering iron temperature adjustment knob ("B2" from the control panel).
4. Start using the soldering iron when desired temperature is reached.
5. Deactivate the SOLDER IRON after usage. To deactivate turn the solder iron set temperature knob B2 counterclockwise until a click is heard. During this time, the display for soldering iron temperature will alternate from "Off" to actual temperature display. Once the temperature drops to approximately **90°C** the system will display "OFF" on the panel. It is now safe to switch off the main power switch.

G. System Settings

The device has a system settings menu which can be access by following the procedures below:

1. Turn off unit.
2. Adjust all knobs to the minimum position or in the case of soldering iron and hot air gun set temperature knob to the OFF position.
3. Power up unit by switching the power switch to ON.
4. While the "AOYUE" name is scrolling simultaneously turn the soldering iron and hot air gun set temperature knob to ON position.
5. If successful the display would show "Set 000" indicating that the system settings menu has be accessed.
6. Adjust selection menu with the air flow adjustment knob "A1".
7. Selection menu is adjustable from 0 to 7. To enter the selected function, turn the hot air gun knob to off position .

OPERATING GUIDELINES

Selection Menu	Function
0	None
1	Soldering Iron Sleep Timer
2	Hot Air Gun Sleep Timer
3	Temperature Scale Adjustment
4	Air Flow Calibration
5	Soldering Iron Digital Offset
6	Hot Air Gun Digital Offset
7	AC Line Frequency Selection

H. Activating Soldering Iron Auto-Sleep Mode

The soldering iron's SLEEP mode can be activated by following the set of procedures below:

1. Follow **System Setting** procedures 1 to 6.
2. Adjust system selection menu to Set 001, then turn the hot air gun knob to off position .
3. If successful the display "B1" would show "###t" indicating soldering iron sleep timer setting is being set.
4. Adjust the sleep timer with the air flow adjustment knob "A1", Sleep timer is adjustable from 1 to 60 minutes with "OFFt" signifying sleep timer is turned off.
5. Save the selected timer settings and exit from the sleep timer adjustment menu by pressing the turn the soldering iron knob to off position .
6. If the sleep mode is activated the sleep timer will start counting down once the soldering iron is activated.
7. When the sleep timer expires system will start cooling down the soldering iron while the display shows a flashing OFF to signify soldering iron is currently preparing to go into sleep mode. Once soldering iron actual temperature goes below 90 degrees, the display "B1" would show " - - - - " four dashes indicating soldering iron is now in sleep mode.