

### FEATURES

- isoPower* integrated, isolated dc-to-dc converter
- Regulated 5 V or 3.3 V output
- Up to 400 mW output power
- Dual dc-to-25 Mbps (NRZ) signal isolation channels
- 16-lead SOIC wide body package version
- 16-lead SOIC wide body enhanced creepage version
- High temperature operation: 105°C maximum
- Safety and regulatory approvals

#### UL recognition

5000 V rms for 1 minute per UL 1577

#### CSA Component Acceptance Notice #5A

IEC 60601-1: 250 V rms, 8 mm package (RI-16-1)

IEC 60950-1: 400 V rms, 8 mm package (RI-16-1)

#### VDE certificate of conformity (RW-16)

IEC 60747-5-2 (VDE 0884 Part 2):2003-01

$V_{IORM} = 846$  V peak

#### VDE certificate of conformity, 8 mm package (RI-16-1)

DIN V VDE V 0884-10 (VDE V 0884-10):2006-12

$V_{IORM} = 846$  V peak

### APPLICATIONS

- RS-232/RS-422/RS-485 transceivers
- Industrial field bus isolation
- Isolated sensor interfaces
- Industrial PLCs

### GENERAL DESCRIPTION

The ADuM6200/ADuM6201/ADuM6202<sup>1</sup> are dual-channel digital isolators with *isoPower*®, an integrated, isolated dc-to-dc converter. Based on the Analog Devices, Inc., *iCoupler*® technology, the dc-to-dc converter provides up to 400 mW of regulated, isolated power at either 5.0 V or 3.3 V from a 5.0 V input supply, or at 3.3 V from a 3.3 V supply at the power levels shown in Table 1. These devices eliminate the need for a separate, isolated dc-to-dc converter in low power, isolated designs. The *iCoupler* chip scale transformer technology is used to isolate the logic signals and for the magnetic components of the dc-to-dc converter. The result is a small form factor, total isolation solution.

The ADuM6200/ADuM6201/ADuM6202 isolators provide two independent isolation channels in a variety of channel configurations and data rates (see the Ordering Guide for more information).

*isoPower* uses high frequency switching elements to transfer power through its transformer. Special care must be taken during printed circuit board (PCB) layout to meet emissions standards. See the AN-0971 Application Note for board layout recommendations.

<sup>1</sup> Protected by U.S. Patents 5,952,849; 6,873,065; 6,903,578; and 7,075,329; other patents are pending.

#### Rev. C

Information furnished by Analog Devices is believed to be accurate and reliable. However, no responsibility is assumed by Analog Devices for its use, nor for any infringements of patents or other rights of third parties that may result from its use. Specifications subject to change without notice. No license is granted by implication or otherwise under any patent or patent rights of Analog Devices. Trademarks and registered trademarks are the property of their respective owners.

### FUNCTIONAL BLOCK DIAGRAMS

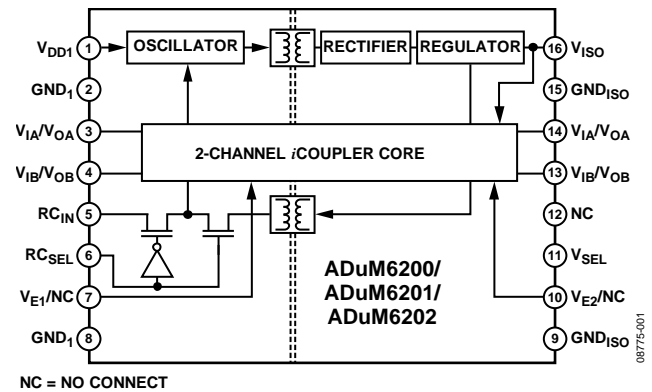

Figure 1.

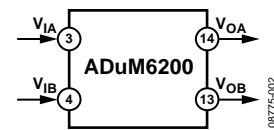

Figure 2. ADuM6200

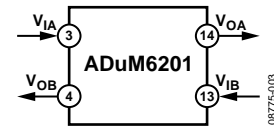

Figure 3. ADuM6201

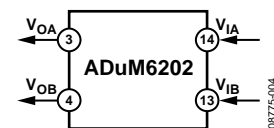

Figure 4. ADuM6202

Table 1. Power Levels

Input Voltage (V)	Output Voltage (V)	Output Power (mW)
5.0	5.0	400
5.0	3.3	330
3.3	3.3	132

## TABLE OF CONTENTS

Features .....	1	Pin Configurations and Function Descriptions .....	11
Applications .....	1	Truth Table .....	13
General Description .....	1	Typical Performance Characteristics .....	14
Functional Block Diagrams .....	1	Terminology .....	17
Revision History .....	2	Applications Information .....	18
Specifications .....	3	PCB Layout .....	18
Electrical Characteristics—5 V Primary Input Supply/ 5 V Secondary Isolated Supply .....	3	Start-Up Behavior .....	18
Electrical Characteristics—3.3 V Primary Input Supply/ 3.3 V Secondary Isolated Supply .....	4	EMI Considerations .....	19
Electrical Characteristics—5 V Primary Input Supply/ 3.3 V Secondary Isolated Supply .....	6	Propagation Delay Parameters .....	19
Package Characteristics .....	7	DC Correctness and Magnetic Field Immunity .....	19
Regulatory Information .....	8	Power Consumption .....	20
Insulation and Safety-Related Specifications .....	8	Current-Limit and Thermal Overload Protection .....	21
Insulation Characteristics .....	9	Power Considerations .....	21
Recommended Operating Conditions .....	9	Thermal Analysis .....	22
Absolute Maximum Ratings .....	10	Increasing Available Power .....	22
ESD Caution .....	10	Insulation Lifetime .....	23
		Outline Dimensions .....	24
		Ordering Guide .....	25

## REVISION HISTORY

### 6/12—Rev. B to Rev. C

Created Hyperlink for Safety and Regulatory Approvals Entry in Features Section .....	1
Changes to Table 15 .....	8
Changes to Insulation Characteristics Section .....	9

### 8/11—Rev. A to Rev. B

Change to Features Section .....	1
Changes to Table 15 .....	8

### 8/11—Rev. 0 to Rev. A

Added 16-Lead SOIC (RI-16-1) Package .....	Universal
Changes to Features Section .....	1
Changes to Table 15 and Table 16 .....	8
Changes to Table 20 .....	10

### 10/10—Revision 0: Initial Version

## SPECIFICATIONS

### ELECTRICAL CHARACTERISTICS—5 V PRIMARY INPUT SUPPLY/5 V SECONDARY ISOLATED SUPPLY

Typical specifications are at  $T_A = 25^\circ\text{C}$ ,  $V_{DD1} = V_{SEL} = V_{ISO} = 5\text{ V}$ . Minimum/maximum specifications apply over the entire recommended operation range, which is  $4.5\text{ V} \leq V_{DD1}$ ,  $V_{SEL}$ ,  $V_{ISO} \leq 5.5\text{ V}$ , and  $-40^\circ\text{C} \leq T_A \leq +105^\circ\text{C}$ , unless otherwise noted. Switching specifications are tested with  $C_L = 15\text{ pF}$  and CMOS signal levels, unless otherwise noted.

**Table 2. DC-to-DC Converter Static Specifications**

Parameter	Symbol	Min	Typ	Max	Unit	Test Conditions/Comments
DC-TO-DC CONVERTER SUPPLY						
Setpoint	$V_{ISO}$	4.7	5.0	5.4	V	$I_{ISO} = 0\text{ mA}$
Line Regulation	$V_{ISO(LINE)}$		1		mV/V	$I_{ISO} = 40\text{ mA}$ , $V_{DD1} = 4.5\text{ V to }5.5\text{ V}$
Load Regulation	$V_{ISO(LOAD)}$		1	5	%	$I_{ISO} = 8\text{ mA to }72\text{ mA}$
Output Ripple	$V_{ISO(RIP)}$		75		mV p-p	20 MHz bandwidth, $C_{BO} = 0.1\text{ }\mu\text{F}  10\text{ }\mu\text{F}$ , $I_{ISO} = 72\text{ mA}$
Output Noise	$V_{ISO(NOISE)}$		200		mV p-p	$C_{BO} = 0.1\text{ }\mu\text{F}  10\text{ }\mu\text{F}$ , $I_{ISO} = 72\text{ mA}$
Switching Frequency	$f_{OSC}$		180		MHz	
PWM Frequency	$f_{PWM}$		625		kHz	
Output Supply Current	$I_{ISO(MAX)}$	80			mA	$V_{ISO} > 4.5\text{ V}$
Efficiency at $I_{ISO(MAX)}$			32		%	$I_{ISO} = 80\text{ mA}$
$I_{DD1}$ , No $V_{ISO}$ Load	$I_{DD1(Q)}$		10	26	mA	
$I_{DD1}$ , Full $V_{ISO}$ Load	$I_{DD1(MAX)}$		290		mA	

**Table 3. DC-to-DC Converter Dynamic Specifications**

Parameter	Symbol	1 Mbps—A or C Grade			25 Mbps—C Grade			Unit	Test Conditions/ Comments
		Min	Typ	Max	Min	Typ	Max		
SUPPLY CURRENT									
Input	$I_{DD1(D)}$		9			34		mA	No $V_{ISO}$ load
ADuM6200			10			38		mA	No $V_{ISO}$ load
ADuM6202			11			41		mA	No $V_{ISO}$ load
Available to Load	$I_{ISO(LOAD)}$		80			74		mA	
ADuM6200			80			72		mA	
ADuM6202			80			70		mA	

**Table 4. Switching Specifications**

Parameter	Symbol	A Grade			C Grade			Unit	Test Conditions/ Comments
		Min	Typ	Max	Min	Typ	Max		
SWITCHING SPECIFICATIONS									
Data Rate				1			25	Mbps	Within PWD limit
Propagation Delay	$t_{PHL}$ , $t_{PLH}$		55	100		45	60	ns	50% input to 50% output
Pulse Width Distortion	PWD			40			6	ns	$ t_{PLH} - t_{PHL} $
Change vs. Temperature						5		ps/°C	
Pulse Width	PW	1000			40			ns	Within PWD limit
Propagation Delay Skew	$t_{PSK}$			50			15	ns	Between any two units
Channel Matching									
Codirectional <sup>1</sup>	$t_{PSKCD}$			50			6	ns	
Opposing Directional <sup>2</sup>	$t_{PSKOD}$			50			15	ns	

<sup>1</sup> Codirectional channel matching is the absolute value of the difference in propagation delays between any two channels with inputs on the same side of the isolation barrier.

<sup>2</sup> Opposing directional channel matching is the absolute value of the difference in propagation delays between any two channels with inputs on opposite sides of the isolation barrier.

Table 5. Input and Output Characteristics

Parameter	Symbol	Min	Typ	Max	Unit	Test Conditions/ Comments
DC SPECIFICATIONS						
Logic High Input Threshold	$V_{IH}$	$0.7 \times V_{ISO}$ or $0.7 \times V_{DD1}$			V	
Logic Low Input Threshold	$V_{IL}$				V	
Logic High Output Voltages	$V_{OH}$	$V_{DD1} - 0.3$ or $V_{ISO} - 0.3$	5.0	$0.3 \times V_{ISO}$ or $0.3 \times V_{DD1}$	V	$I_{Ox} = -20 \mu A, V_{Ix} = V_{IxH}$
		$V_{DD1} - 0.5$ or $V_{ISO} - 0.5$	4.8		V	$I_{Ox} = -4 \text{ mA}, V_{Ix} = V_{IxH}$
Logic Low Output Voltages	$V_{OL}$				V	$I_{Ox} = 20 \mu A, V_{Ix} = V_{IxL}$
					V	$I_{Ox} = 4 \text{ mA}, V_{Ix} = V_{IxL}$
Undervoltage Lockout	UVLO					$V_{DD1}, V_{ISO}$ supplies
Positive-Going Threshold	$V_{UV+}$	2.7			V	
Negative-Going Threshold	$V_{UV-}$	2.4			V	
Hysteresis	$V_{UVH}$	0.3			V	
Input Currents per Channel	$I_I$	-20	+0.01	+20	$\mu A$	$0 \text{ V} \leq V_{Ix} \leq V_{DD1}$
AC SPECIFICATIONS						
Output Rise/Fall Time	$t_R/t_F$	2.5			ns	10% to 90%
Common-Mode Transient Immunity <sup>1</sup>	CM	25	35		kV/ $\mu s$	$V_{Ix} = V_{DD1}$ or $V_{ISO}, V_{CM} = 1000 \text{ V}$ , transient magnitude = 800 V
Refresh Rate	$f_r$	1.0			Mbps	

<sup>1</sup> |CM| is the maximum common-mode voltage slew rate that can be sustained while maintaining  $V_O > 0.7 \times V_{DD1}$  or  $0.7 \times V_{ISO}$  for a high input or  $V_O < 0.3 \times V_{DD1}$  or  $0.3 \times V_{ISO}$  for a low input. The common-mode voltage slew rates apply to both rising and falling common-mode voltage edges.

### ELECTRICAL CHARACTERISTICS—3.3 V PRIMARY INPUT SUPPLY/3.3 V SECONDARY ISOLATED SUPPLY

Typical specifications are at  $T_A = 25^\circ\text{C}$ ,  $V_{DD1} = V_{ISO} = 3.3 \text{ V}$ ,  $V_{SEL} = \text{GND}_{ISO}$ . Minimum/maximum specifications apply over the entire recommended operation range, which is  $3.0 \text{ V} \leq V_{DD1}, V_{SEL}, V_{ISO} \leq 3.6 \text{ V}$ , and  $-40^\circ\text{C} \leq T_A \leq +105^\circ\text{C}$ , unless otherwise noted. Switching specifications are tested with  $C_L = 15 \text{ pF}$  and CMOS signal levels, unless otherwise noted.

Table 6. DC-to-DC Converter Static Specifications

Parameter	Symbol	Min	Typ	Max	Unit	Test Conditions/Comments
DC-TO-DC CONVERTER SUPPLY						
Setpoint	$V_{ISO}$	3.0	3.3	3.6	V	$I_{ISO} = 0 \text{ mA}$
Line Regulation	$V_{ISO(LINE)}$	1			mV/V	$I_{ISO} = 20 \text{ mA}, V_{DD1} = 3.0 \text{ V to } 3.6 \text{ V}$
Load Regulation	$V_{ISO(LOAD)}$	1		5	%	$I_{ISO} = 4 \text{ mA to } 36 \text{ mA}$
Output Ripple	$V_{ISO(RIP)}$	50			mV p-p	20 MHz bandwidth, $C_{BO} = 0.1 \mu F    10 \mu F, I_{ISO} = 36 \text{ mA}$
Output Noise	$V_{ISO(NOISE)}$	130			mV p-p	$C_{BO} = 0.1 \mu F    10 \mu F, I_{ISO} = 36 \text{ mA}$
Switching Frequency	$f_{OSC}$	180			MHz	
PWM Frequency	$f_{PWM}$	625			kHz	
Output Supply Current	$I_{ISO(MAX)}$	40			mA	$V_{ISO} > 3 \text{ V}$
Efficiency at $I_{ISO(MAX)}$		29			%	$I_{ISO} = 40 \text{ mA}$
$I_{DD1}$ , No $V_{ISO}$ Load	$I_{DD1(Q)}$	10		17	mA	
$I_{DD1}$ , Full $V_{ISO}$ Load	$I_{DD1(MAX)}$	175			mA	

Table 7. DC-to-DC Converter Dynamic Specifications

Parameter	Symbol	1 Mbps—A or C Grade			25 Mbps—C Grade			Unit	Test Conditions/ Comments
		Min	Typ	Max	Min	Typ	Max		
SUPPLY CURRENT									
Input	$I_{DD1(D)}$								
ADuM6200			6			23		mA No $V_{ISO}$ load	
ADuM6201			7			25		mA No $V_{ISO}$ load	
ADuM6202			8			27		mA No $V_{ISO}$ load	
Available to Load	$I_{ISO(LOAD)}$								
ADuM6200			40			36		mA	
ADuM6201			40			35		mA	
ADuM6202			40			34		mA	

Table 8. Switching Specifications

Parameter	Symbol	A Grade			C Grade			Unit	Test Conditions/ Comments
		Min	Typ	Max	Min	Typ	Max		
SWITCHING SPECIFICATIONS									
Data Rate				1			25	Mbps	Within PWD limit
Propagation Delay	$t_{PHL}, t_{PLH}$		60	100		45	65	ns	50% input to 50% output
Pulse Width Distortion	PWD			40			6	ns	$ t_{PLH} - t_{PHL} $
Change vs. Temperature						5		ps/°C	
Pulse Width	PW	1000			40			ns	Within PWD limit
Propagation Delay Skew	$t_{PSK}$			50			45	ns	Between any two units
Channel Matching									
Codirectional <sup>1</sup>	$t_{PSKCD}$			50			6	ns	
Opposing Directional <sup>2</sup>	$t_{PSKOD}$			50			15	ns	

<sup>1</sup> Codirectional channel matching is the absolute value of the difference in propagation delays between any two channels with inputs on the same side of the isolation barrier.

<sup>2</sup> Opposing directional channel matching is the absolute value of the difference in propagation delays between any two channels with inputs on opposite sides of the isolation barrier.

Table 9. Input and Output Characteristics

Parameter	Symbol	Min	Typ	Max	Unit	Test Conditions/ Comments
DC SPECIFICATIONS						
Logic High Input Threshold	$V_{IH}$	$0.7 \times V_{ISO}$ or $0.7 \times V_{DD1}$			V	
Logic Low Input Threshold	$V_{IL}$	$0.3 \times V_{ISO}$ or $0.3 \times V_{DD1}$			V	
Logic High Output Voltages	$V_{OH}$	$V_{DD1} - 0.3$ or $V_{ISO} - 0.3$	3.3		V	$I_{Ox} = -20 \mu A, V_{Ix} = V_{IxH}$
		$V_{DD1} - 0.5$ or $V_{ISO} - 0.5$	3.1		V	$I_{Ox} = -4 \text{ mA}, V_{Ix} = V_{IxH}$
Logic Low Output Voltages	$V_{OL}$		0.0	0.1	V	$I_{Ox} = 20 \mu A, V_{Ix} = V_{IxL}$
			0.0	0.4	V	$I_{Ox} = 4 \text{ mA}, V_{Ix} = V_{IxL}$
Undervoltage Lockout	UVLO					$V_{DD1}, V_{ISO}$ supplies
Positive-Going Threshold	$V_{UV+}$		2.7		V	
Negative-Going Threshold	$V_{UV-}$		2.4		V	
Hysteresis	$V_{UVH}$		0.3		V	
Input Currents per Channel	$I_I$	-20	+0.01	+20	$\mu A$	$0 \text{ V} \leq V_{Ix} \leq V_{DD1}$
AC SPECIFICATIONS						
Output Rise/Fall Time	$t_R/t_F$		2.5		ns	10% to 90%
Common-Mode Transient Immunity <sup>1</sup>	$ CM $	25	35		kV/ $\mu s$	$V_{Ix} = V_{DD1}$ or $V_{ISO}, V_{CM} = 1000 \text{ V}$ , transient magnitude = 800 V
Refresh Rate	$f_r$		1.0		Mbps	

<sup>1</sup>  $|CM|$  is the maximum common-mode voltage slew rate that can be sustained while maintaining  $V_O > 0.7 \times V_{DD1}$  or  $0.7 \times V_{ISO}$  for a high input or  $V_O < 0.3 \times V_{DD1}$  or  $0.3 \times V_{ISO}$  for a low input. The common-mode voltage slew rates apply to both rising and falling common-mode voltage edges.

**ELECTRICAL CHARACTERISTICS—5 V PRIMARY INPUT SUPPLY/3.3 V SECONDARY ISOLATED SUPPLY**

Typical specifications are at  $T_A = 25^\circ\text{C}$ ,  $V_{DD1} = 5.0\text{ V}$ ,  $V_{ISO} = 3.3\text{ V}$ ,  $V_{SEL} = \text{GND}_{ISO}$ . Minimum/maximum specifications apply over the entire recommended operation range, which is  $4.5\text{ V} \leq V_{DD1} \leq 5.5\text{ V}$ ,  $3.0\text{ V} \leq V_{ISO} \leq 3.6\text{ V}$ , and  $-40^\circ\text{C} \leq T_A \leq +105^\circ\text{C}$ , unless otherwise noted. Switching specifications are tested with  $C_L = 15\text{ pF}$  and CMOS signal levels, unless otherwise noted.

**Table 10. DC-to-DC Converter Static Specifications**

Parameter	Symbol	Min	Typ	Max	Unit	Test Conditions/Comments
DC-TO-DC CONVERTER SUPPLY						
Setpoint	$V_{ISO}$	3.0	3.3	3.6	V	$I_{ISO} = 0\text{ mA}$
Line Regulation	$V_{ISO(LINE)}$		1		mV/V	$I_{ISO} = 50\text{ mA}$ , $V_{DD1} = 3.0\text{ V to } 3.6\text{ V}$
Load Regulation	$V_{ISO(LOAD)}$		1	5	%	$I_{ISO} = 6\text{ mA to } 54\text{ mA}$
Output Ripple	$V_{ISO(RIP)}$		50		mV p-p	20 MHz bandwidth, $C_{BO} = 0.1\text{ }\mu\text{F}  10\text{ }\mu\text{F}$ , $I_{ISO} = 90\text{ mA}$
Output Noise	$V_{ISO(NOISE)}$		130		mV p-p	$C_{BO} = 0.1\text{ }\mu\text{F}  10\text{ }\mu\text{F}$ , $I_{ISO} = 90\text{ mA}$
Switching Frequency	$f_{OSC}$		180		MHz	
PWM Frequency	$f_{PWM}$		625		kHz	
Output Supply Current	$I_{ISO(MAX)}$	100			mA	$V_{ISO} > 3\text{ V}$
Efficiency at $I_{ISO(MAX)}$			25		%	$I_{ISO} = 100\text{ mA}$
$I_{DD1}$ , No $V_{ISO}$ Load	$I_{DD1(Q)}$		7	13	mA	
$I_{DD1}$ , Full $V_{ISO}$ Load	$I_{DD1(MAX)}$		230		mA	

**Table 11. DC-to-DC Converter Dynamic Specifications**

Parameter	Symbol	1 Mbps—A or C Grade			25 Mbps—C Grade			Unit	Test Conditions/Comments
		Min	Typ	Max	Min	Typ	Max		
SUPPLY CURRENT									
Input	$I_{DD1(D)}$								
ADuM6200			6			22		mA	No $V_{ISO}$ load
ADuM6201			6			23		mA	No $V_{ISO}$ load
ADuM6202			6			24		mA	No $V_{ISO}$ load
Available to Load	$I_{ISO(LOAD)}$								
ADuM6200			100			96		mA	
ADuM6201			100			95		mA	
ADuM6202			100			94		mA	

**Table 12. Switching Specifications**

Parameter	Symbol	A Grade			C Grade			Unit	Test Conditions/Comments
		Min	Typ	Max	Min	Typ	Max		
SWITCHING SPECIFICATIONS									
Data Rate				1		25		Mbps	Within PWD limit
Propagation Delay	$t_{PHL}$ , $t_{PLH}$		60	100		45	65	ns	50% input to 50% output
Pulse Width Distortion	PWD			40			6	ns	$ t_{PLH} - t_{PHL} $
Change vs. Temperature						5		ps/ $^\circ\text{C}$	
Pulse Width	PW	1000			40			ns	Within PWD limit
Propagation Delay Skew	$t_{PSK}$			50			15	ns	Between any two units
Channel Matching									
Codirectional <sup>1</sup>	$t_{PSKCD}$			50			6	ns	
Opposing Directional <sup>2</sup>	$t_{PSKOD}$			50			15	ns	

<sup>1</sup> Codirectional channel matching is the absolute value of the difference in propagation delays between any two channels with inputs on the same side of the isolation barrier.

<sup>2</sup> Opposing directional channel matching is the absolute value of the difference in propagation delays between any two channels with inputs on opposite sides of the isolation barrier.

Table 13. Input and Output Characteristics

Parameter	Symbol	Min	Typ	Max	Unit	Test Conditions/Comments
DC SPECIFICATIONS						
Logic High Input Threshold	$V_{IH}$	$0.7 \times V_{ISO}$ or $0.7 \times V_{DD1}$			V	
Logic Low Input Threshold	$V_{IL}$			$0.3 \times V_{ISO}$ or $0.3 \times V_{DD1}$	V	
Logic High Output Voltages	$V_{OH}$	$V_{DD1} - 0.3$ or $V_{ISO} - 0.3$	$V_{DD1}$ or $V_{ISO}$		V	$I_{Ox} = -20 \mu A, V_{Ix} = V_{IxH}$
		$V_{DD1} - 0.5$ or $V_{ISO} - 0.5$	$V_{DD1} - 0.2$ or $V_{ISO} - 0.2$		V	$I_{Ox} = -4 \text{ mA}, V_{Ix} = V_{IxH}$
Logic Low Output Voltages	$V_{OL}$		0.0	0.1	V	$I_{Ox} = 20 \mu A, V_{Ix} = V_{IxL}$
			0.0	0.4	V	$I_{Ox} = 4 \text{ mA}, V_{Ix} = V_{IxL}$
Undervoltage Lockout	UVLO					$V_{DD1}, V_{ISO}$ supplies
Positive-Going Threshold	$V_{UV+}$		2.7		V	
Negative-Going Threshold	$V_{UV-}$		2.4		V	
Hysteresis	$V_{UVH}$		0.3		V	
Input Currents per Channel	$I_I$	-20	+0.01	+20	$\mu A$	$0 \text{ V} \leq V_{Ix} \leq V_{DD1}$
AC SPECIFICATIONS						
Output Rise/Fall Time	$t_R/t_F$		2.5		ns	10% to 90%
Common-Mode Transient Immunity <sup>1</sup>	$ CM $	25	35		kV/ $\mu s$	$V_{Ix} = V_{DD1}$ or $V_{ISO}, V_{CM} = 1000 \text{ V}$ , transient magnitude = 800 V
Refresh Rate	$f_r$		1.0		Mbps	

<sup>1</sup>  $|CM|$  is the maximum common-mode voltage slew rate that can be sustained while maintaining  $V_O > 0.7 \times V_{DD1}$  or  $0.7 \times V_{ISO}$  for a high input or  $V_O < 0.3 \times V_{DD1}$  or  $0.3 \times V_{ISO}$  for a low input. The common-mode voltage slew rates apply to both rising and falling common-mode voltage edges.

## PACKAGE CHARACTERISTICS

Table 14.

Parameter	Symbol	Min	Typ	Max	Unit	Test Conditions/Comments
RESISTANCE AND CAPACITANCE						
Resistance (Input-to-Output) <sup>1</sup>	$R_{I-O}$		$10^{12}$		$\Omega$	
Capacitance (Input-to-Output) <sup>1</sup>	$C_{I-O}$		2.2		pF	$f = 1 \text{ MHz}$
Input Capacitance <sup>2</sup>	$C_I$		4.0		pF	
IC Junction-to-Ambient Thermal Resistance	$\theta_{JA}$		45		$^{\circ}C/W$	Thermocouple is located at the center of the package underside; test conducted on a 4-layer board with thin traces <sup>3</sup>
THERMAL SHUTDOWN						
Thermal Shutdown Threshold	$TS_{SD}$		150		$^{\circ}C$	$T_J$ rising
Thermal Shutdown Hysteresis	$TS_{SD-HYS}$		20		$^{\circ}C$	

<sup>1</sup> This device is considered a 2-terminal device; Pin 1 through Pin 8 are shorted together, and Pin 9 through Pin 16 are shorted together.

<sup>2</sup> Input capacitance is from any input data pin to ground.

<sup>3</sup> Refer to the Thermal Analysis section for thermal model definitions.

**REGULATORY INFORMATION**

The [ADuM6200/ADuM6201/ADuM6202](#) are approved by the organizations listed in Table 15. Refer to Table 20 and the Insulation Lifetime section for more information about the recommended maximum working voltages for specific cross-insulation waveforms and insulation levels.

**Table 15.**

UL <sup>1</sup>	CSA	VDE
Recognized under UL 1577 component recognition program	Approved under CSA Component Acceptance Notice #5A	RW-16 package: <sup>2</sup> Certified according to IEC 60747-5-2 (VDE 0884 Part 2):2003-01 Basic insulation, 846 V peak
Single protection, 5000 V rms isolation voltage	Basic insulation per CSA 60950-1-07 and IEC 60950-1, 600 V rms (848 V peak) maximum working voltage  RW-16 package: Reinforced insulation per CSA 60950-1-07 and IEC 60950-1, 380 V rms (537 V peak) maximum working voltage Reinforced insulation per IEC 60601-1, 125 V rms (176 V peak) maximum working voltage RI-16-1 package: Reinforced insulation per CSA 60950-1-07 and IEC 60950-1, 400 V rms (565 V peak) maximum working voltage Reinforced insulation per IEC 60601-1, 250 V rms (353 V peak) maximum working voltage	RI-16-1 package: <sup>3</sup> Certified according to DIN V VDE V 0884-10 (VDE V 0884-10):2006-12 Reinforced insulation, 846 V peak
File E214100	File 205078	File 2471900-4880-0001

<sup>1</sup> In accordance with UL 1577, each [ADuM6200/ADuM6201/ADuM6202](#) is proof-tested by applying an insulation test voltage  $\geq 6000$  V rms for 1 sec (current leakage detection limit = 15  $\mu$ A).

<sup>2</sup> In accordance with IEC 60747-5-2 (VDE 0884 Part 2):2003-01, each [ADuM6200/ADuM6201/ADuM6202](#) in the RW-16 package is proof-tested by applying an insulation test voltage  $\geq 1590$  V peak for 1 sec (partial discharge detection limit = 5 pC). The asterisk (\*) marking branded on the component designates IEC 60747-5-2 (VDE 0884 Part 2):2003-01 approval.

<sup>3</sup> In accordance with DIN V VDE V 0884-10 (VDE V 0884-10):2006-12, each [ADuM6200/ADuM6201/ADuM6202](#) in the RI-16-1 package is proof-tested by applying an insulation test voltage  $\geq 1590$  V peak for 1 sec (partial discharge detection limit = 5 pC). The asterisk (\*) marking branded on the component designates DIN V VDE V 0884-10 (VDE V 0884-10):2006-12 approval.

**INSULATION AND SAFETY-RELATED SPECIFICATIONS****Table 16.**

Parameter	Symbol	Value	Unit	Test Conditions/Comments
Rated Dielectric Insulation Voltage		5000	V rms	1-minute duration
Minimum External Air Gap (Clearance)	L(I01)	8.0	mm	Measured from input terminals to output terminals, shortest distance through air
Minimum External Tracking (Creepage)	L(I02)			Measured from input terminals to output terminals, shortest distance path along body
RW-16 Package		7.6	mm	
RI-16-1 Package		8.3 min	mm	
Minimum Internal Distance (Internal Clearance)		0.017 min	mm	Distance through insulation
Tracking Resistance (Comparative Tracking Index)	CTI	>175	V	DIN IEC 112/VDE 0303, Part 1
Material Group		IIIa		Material Group (DIN VDE 0110, 1/89, Table 1)



**INSULATION CHARACTERISTICS**

**IEC 60747-5-2 (VDE 0884 Part 2):2003-01 and DIN V VDE V 0884-10 (VDE V 0884-10):2006-12**

These isolators are suitable for reinforced electrical isolation only within the safety limit data. Maintenance of the safety data is ensured by protective circuits. The asterisk (\*) marking branded on the components designates IEC 60747-5-2 (VDE 0884 Part 2):2003-01 or DIN V VDE V 0884-10 (VDE V 0884-10):2006-12 approval.

**Table 17.**

Description	Test Conditions/Comments	Symbol	Characteristic	Unit
Installation Classification per DIN VDE 0110 For Rated Mains Voltage ≤ 300 V rms For Rated Mains Voltage ≤ 450 V rms For Rated Mains Voltage ≤ 600 V rms			I to IV I to II I to II	
Climatic Classification			40/105/21	
Pollution Degree per DIN VDE 0110, Table 1			2	
Maximum Working Insulation Voltage		$V_{IORM}$	846	V peak
Input-to-Output Test Voltage Method b1	$V_{IORM} \times 1.875 = V_{PR}$ , 100% production test, $t_m = 1$ sec, partial discharge < 5 pC	$V_{PR}$	1590	V peak
Method a		$V_{PR}$		
After Environmental Tests Subgroup 1	$V_{IORM} \times 1.6 = V_{PR}$ , $t_m = 60$ sec, partial discharge < 5 pC		1375	V peak
After Input and/or Safety Tests Subgroup 2 and Subgroup 3	$V_{IORM} \times 1.2 = V_{PR}$ , $t_m = 60$ sec, partial discharge < 5 pC		1018	V peak
Highest Allowable Overvoltage	Transient overvoltage, $t_{TR} = 10$ sec	$V_{IOTM}$	6000	V peak
Safety-Limiting Values	Maximum value allowed in the event of a failure (see Figure 5)			
Case Temperature		$T_S$	150	°C
Side 1 Current ( $I_{DD1}$ )		$I_{S1}$	555	mA
Insulation Resistance at $T_S$	$V_{IO} = 500$ V	$R_S$	>10 <sup>9</sup>	Ω

**Thermal Derating Curve**

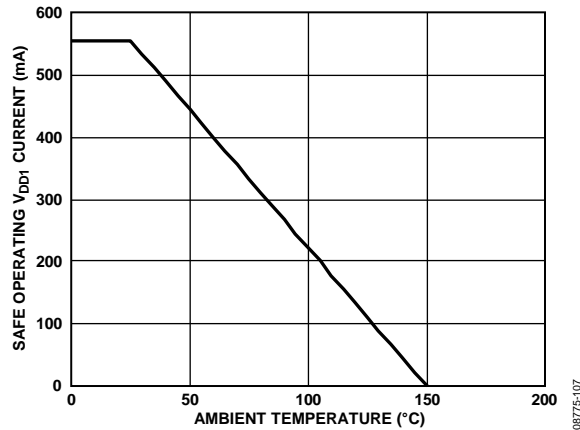

Figure 5. Thermal Derating Curve, Dependence of Safety-Limiting Values on Case Temperature, per DIN EN 60747-5-2

**RECOMMENDED OPERATING CONDITIONS**

**Table 18.**

Parameter	Symbol	Min	Max	Unit	Test Conditions/Comments
TEMPERATURE Operating Temperature	$T_A$	-40	+105	°C	Operation at 105°C requires reduction of the maximum load current as specified in Table 19
SUPPLY VOLTAGES $V_{DD1} @ V_{SEL} = 0$ V	$V_{DD1}$	3.0	5.5	V	Each voltage is relative to its respective ground
$V_{DD1} @ V_{SEL} = V_{ISO}$	$V_{DD1}$	4.5	5.5	V	

## ABSOLUTE MAXIMUM RATINGS

$T_A = 25^\circ\text{C}$ , unless otherwise noted.

Table 19.

Parameter	Rating
Storage Temperature ( $T_{ST}$ )	$-55^\circ\text{C}$ to $+150^\circ\text{C}$
Ambient Operating Temperature ( $T_A$ )	$-40^\circ\text{C}$ to $+105^\circ\text{C}$
Supply Voltages ( $V_{DD1}$ , $V_{ISO}$ ) <sup>1</sup>	$-0.5\text{ V}$ to $+7.0\text{ V}$
Input Voltage ( $V_{IA}$ , $V_{IB}$ , $V_{E1}$ , $V_{E2}$ , $V_{SEL}$ , $RC_{IN}$ , $RC_{SEL}$ ) <sup>1,2</sup>	$-0.5\text{ V}$ to $V_{DD1} + 0.5\text{ V}$
Output Voltage ( $V_{OA}$ , $V_{OB}$ ) <sup>1,2</sup>	$-0.5\text{ V}$ to $V_{DDO} + 0.5\text{ V}$
Average Output Current per Pin <sup>3</sup>	$-10\text{ mA}$ to $+10\text{ mA}$
Common-Mode Transients <sup>4</sup>	$-100\text{ kV}/\mu\text{s}$ to $+100\text{ kV}/\mu\text{s}$

<sup>1</sup> Each voltage is relative to its respective ground.

<sup>2</sup>  $V_{DD1}$  and  $V_{DDO}$  refer to the supply voltages on the input and output sides of a given channel, respectively. See the PCB Layout section.

<sup>3</sup> See Figure 5 for maximum rated current values for various temperatures.

<sup>4</sup> Refers to common-mode transients across the isolation barrier. Common-mode transients exceeding the absolute maximum ratings may cause latch-up or permanent damage.

Stresses above those listed under Absolute Maximum Ratings may cause permanent damage to the device. This is a stress rating only; functional operation of the device at these or any other conditions above those indicated in the operational section of this specification is not implied. Exposure to absolute maximum rating conditions for extended periods may affect device reliability.

### ESD CAUTION



#### ESD (electrostatic discharge) sensitive device.

Charged devices and circuit boards can discharge without detection. Although this product features patented or proprietary protection circuitry, damage may occur on devices subjected to high energy ESD. Therefore, proper ESD precautions should be taken to avoid performance degradation or loss of functionality.

Table 20. Maximum Continuous Working Voltage<sup>1</sup>

Parameter	Max	Unit	Applicable Certification
AC Voltage, Bipolar Waveform	424	V peak	All certifications, 50-year operation
AC Voltage, Unipolar Waveform			
Basic Insulation	600	V peak	Working voltage per IEC 60950-1
Reinforced Insulation	565	V peak	
DC Voltage			
Basic Insulation	600	V peak	Working voltage per IEC 60950-1
Reinforced Insulation	565	V peak	

<sup>1</sup> Refers to the continuous voltage magnitude imposed across the isolation barrier. See the Insulation Lifetime section for more information.

## PIN CONFIGURATIONS AND FUNCTION DESCRIPTIONS

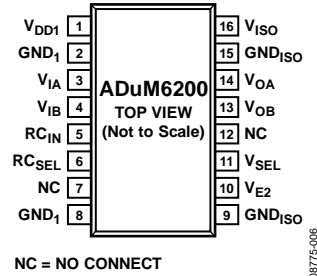

Figure 6. ADuM6200 Pin Configuration

Table 21. ADuM6200 Pin Function Descriptions

Pin No.	Mnemonic	Description
1	$V_{DD1}$	Primary Supply Voltage, 3.0 V to 5.5 V.
2, 8	$GND_1$	Ground Reference for the Primary Side of the Isolator. Pin 2 and Pin 8 are internally connected to each other, and it is recommended that both pins be connected to a common ground.
3	$V_{IA}$	Logic Input A.
4	$V_{IB}$	Logic Input B.
5	$RC_{IN}$	Regulation Control Input. This pin must be connected to the $RC_{OUT}$ pin of a master <i>isoPower</i> device or tied low. This pin must not be tied high if $RC_{SEL}$ is low; this combination causes excessive voltage on the secondary side of the isolator, damaging the ADuM6200 and possibly the devices that it powers.
6	$RC_{SEL}$	Control Input. Determines self-regulation mode ( $RC_{SEL}$ high) or slave mode ( $RC_{SEL}$ low), allowing external regulation. This pin is weakly pulled to the high state. In noisy environments, tie this pin either high or low.
7, 12	NC	No Internal Connection.
9, 15	$GND_{ISO}$	Ground Reference for the Secondary Side of the Isolator. Pin 9 and Pin 15 are internally connected to each other, and it is recommended that both pins be connected to a common ground.
10	$V_{E2}$	Data Enable Input. When this pin is high or not connected, the secondary outputs are active; when this pin is low, the outputs are in a high-Z state.
11	$V_{SEL}$	Output Voltage Selection. When $V_{SEL} = V_{ISO}$ , the $V_{ISO}$ setpoint is 5.0 V. When $V_{SEL} = GND_{ISO}$ , the $V_{ISO}$ setpoint is 3.3 V. In slave regulation mode, this pin has no function.
13	$V_{OB}$	Logic Output B.
14	$V_{OA}$	Logic Output A.
16	$V_{ISO}$	Secondary Supply Voltage. Output for secondary side isolated data channels and external loads.

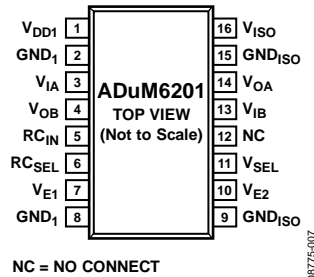

Figure 7. ADuM6201 Pin Configuration

Table 22. ADuM6201 Pin Function Descriptions

Pin No.	Mnemonic	Description
1	V <sub>DD1</sub>	Primary Supply Voltage, 3.0 V to 5.5 V.
2, 8	GND <sub>1</sub>	Ground Reference for the Primary Side of the Isolator. Pin 2 and Pin 8 are internally connected to each other, and it is recommended that both pins be connected to a common ground.
3	V <sub>IA</sub>	Logic Input A.
4	V <sub>OB</sub>	Logic Output B.
5	RC <sub>IN</sub>	Regulation Control Input. This pin must be connected to the RC <sub>OUT</sub> pin of a master <i>iso</i> Power device or tied low. This pin must not be tied high if RC <sub>SEL</sub> is low; this combination causes excessive voltage on the secondary side of the isolator, damaging the ADuM6201 and possibly the devices that it powers.
6	RC <sub>SEL</sub>	Control Input. Determines self-regulation mode (RC <sub>SEL</sub> high) or slave mode (RC <sub>SEL</sub> low), allowing external regulation. This pin is weakly pulled to the high state. In noisy environments, tie this pin either high or low.
7	V <sub>E1</sub>	Data Enable Input. When this pin is high or not connected, the primary output is active; when this pin is low, the output is in a high-Z state.
9, 15	GND <sub>ISO</sub>	Ground Reference for the Secondary Side of the Isolator. Pin 9 and Pin 15 are internally connected to each other, and it is recommended that both pins be connected to a common ground.
10	V <sub>E2</sub>	Data Enable Input. When this pin is high or not connected, the secondary output is active; when this pin is low, the output is in a high-Z state.
11	V <sub>SEL</sub>	Output Voltage Selection. When V <sub>SEL</sub> = V <sub>ISO</sub> , the V <sub>ISO</sub> setpoint is 5.0 V. When V <sub>SEL</sub> = GND <sub>ISO</sub> , the V <sub>ISO</sub> setpoint is 3.3 V. In slave regulation mode, this pin has no function.
12	NC	No Internal Connection.
13	V <sub>IB</sub>	Logic Input B.
14	V <sub>OA</sub>	Logic Output A.
16	V <sub>ISO</sub>	Secondary Supply Voltage. Output for secondary side isolated data channels and external loads.

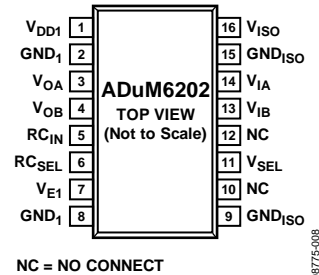

Figure 8. ADuM6202 Pin Configuration

Table 23. ADuM6202 Pin Function Descriptions

Pin No.	Mnemonic	Description
1	V <sub>DD1</sub>	Primary Supply Voltage, 3.0 V to 5.5 V.
2, 8	GND <sub>1</sub>	Ground Reference for the Primary Side of the Isolator. Pin 2 and Pin 8 are internally connected to each other, and it is recommended that both pins be connected to a common ground.
3	V <sub>OA</sub>	Logic Output A.
4	V <sub>OB</sub>	Logic Output B.
5	RC <sub>IN</sub>	Regulation Control Input. This pin must be connected to the RC <sub>OUT</sub> pin of a master <i>isoPower</i> device or tied low. This pin must not be tied high if RC <sub>SEL</sub> is low; this combination causes excessive voltage on the secondary side of the isolator, damaging the ADuM6202 and possibly the devices that it powers.
6	RC <sub>SEL</sub>	Control Input. Determines self-regulation mode (RC <sub>SEL</sub> high) or slave mode (RC <sub>SEL</sub> low), allowing external regulation. This pin is weakly pulled to the high state. In noisy environments, tie this pin either high or low.
7	V <sub>E1</sub>	Data Enable Input. When this pin is high or not connected, the primary outputs are active; when this pin is low, the outputs are in a high-Z state.
9, 15	GND <sub>ISO</sub>	Ground Reference for the Secondary Side of the Isolator. Pin 9 and Pin 15 are internally connected to each other, and it is recommended that both pins be connected to a common ground.
10, 12	NC	No Internal Connection.
11	V <sub>SEL</sub>	Output Voltage Selection. When V <sub>SEL</sub> = V <sub>ISO</sub> , the V <sub>ISO</sub> setpoint is 5.0 V. When V <sub>SEL</sub> = GND <sub>ISO</sub> , the V <sub>ISO</sub> setpoint is 3.3 V. In slave regulation mode, this pin has no function.
13	V <sub>IB</sub>	Logic Input B.
14	V <sub>IA</sub>	Logic Input A.
16	V <sub>ISO</sub>	Secondary Supply Voltage. Output for secondary side isolated data channels and external loads.

## TRUTH TABLE

Table 24. Power Control Truth Table (Positive Logic)

RC <sub>SEL</sub> Input	RC <sub>IN</sub> Input	V <sub>SEL</sub> Input	V <sub>DD1</sub> Input <sup>1</sup>	V <sub>ISO</sub> Output	Operation
High	X	High	5 V	5 V	Self-regulation mode, normal operation
High	X	Low	5 V	3.3 V	Self-regulation mode, normal operation
High	X	Low	3.3 V	3.3 V	Self-regulation mode, normal operation
High	X	High	3.3 V	5 V	This supply configuration is not recommended due to extremely poor efficiency
Low	High	X	X	X	Part runs at maximum open-loop voltage; damage can occur
Low	Low	X	X	0 V	Power supply disabled
Low	RC <sub>OUT(EXT)</sub>	X	X <sup>1</sup>	X	Slave mode; RC <sub>OUT(EXT)</sub> supplied by a master <i>isoPower</i> device

<sup>1</sup> V<sub>DD1</sub> must be common between all *isoPower* devices being regulated by a master *isoPower* part.

TYPICAL PERFORMANCE CHARACTERISTICS

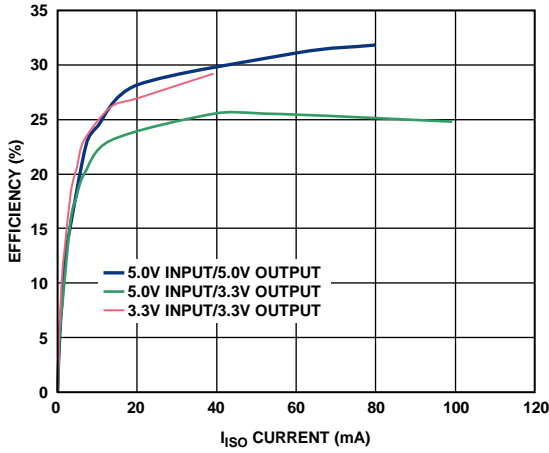

Figure 9. Typical Power Supply Efficiency in All Supported Power Configurations

08775-124

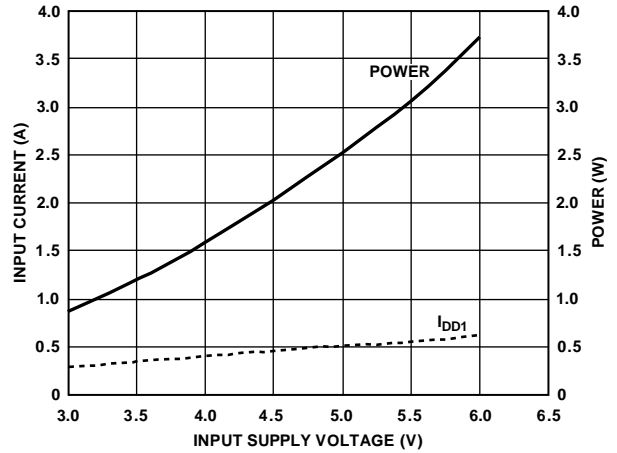

Figure 12. Typical Short-Circuit Input Current and Power vs.  $V_{DD1}$  Supply Voltage

08775-036

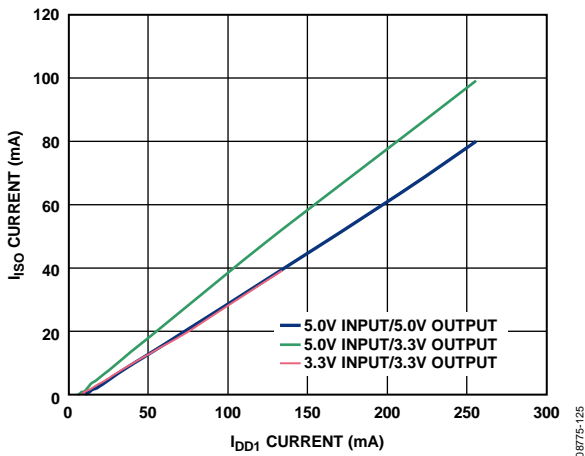

Figure 10. Typical Isolated Output Supply Current vs. Input Current in All Supported Power Configurations

08775-125

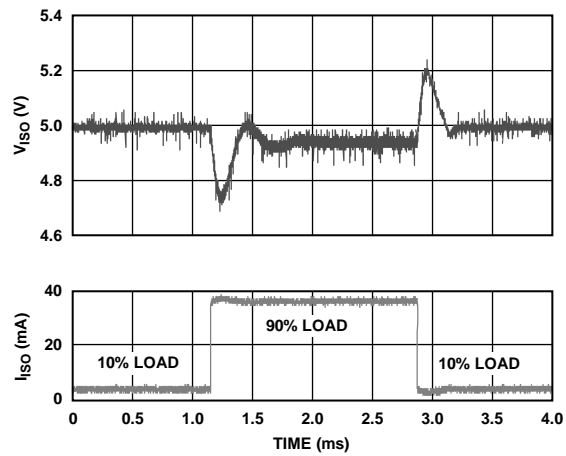

Figure 13. Typical  $V_{ISO}$  Transient Load Response, 5 V Output, 10% to 90% Load Step

08775-127

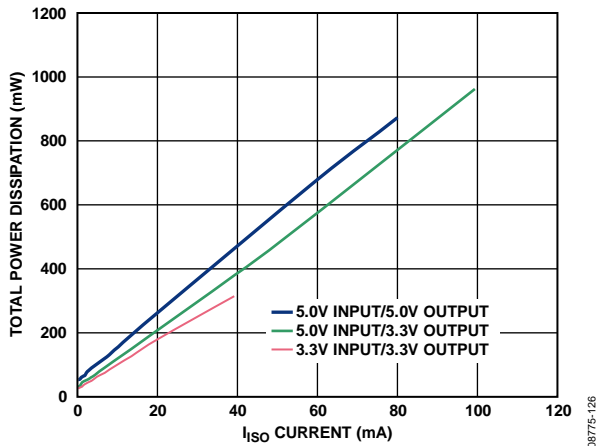

Figure 11. Typical Total Power Dissipation vs. Isolated Output Supply Current in All Supported Power Configurations

08775-126

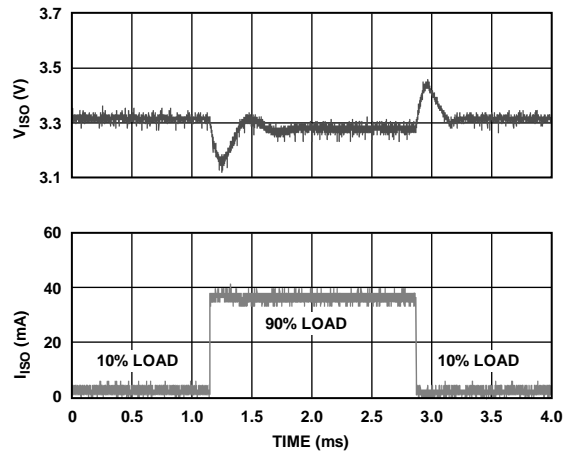

Figure 14. Typical  $V_{ISO}$  Transient Load Response, 3.3 V Output, 10% to 90% Load Step

08775-128

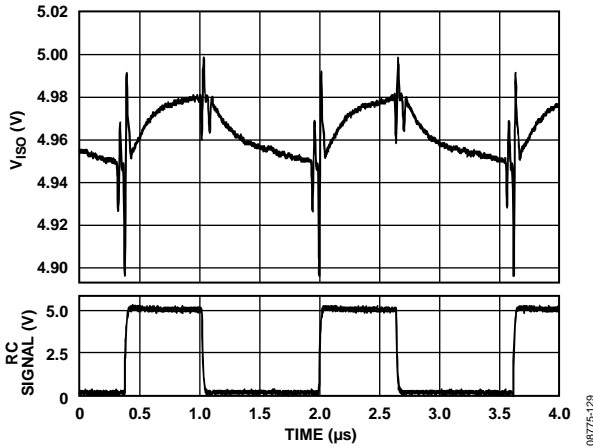

Figure 15. Typical Output Voltage Ripple at 90% Load,  $V_{ISO} = 5\text{ V}$

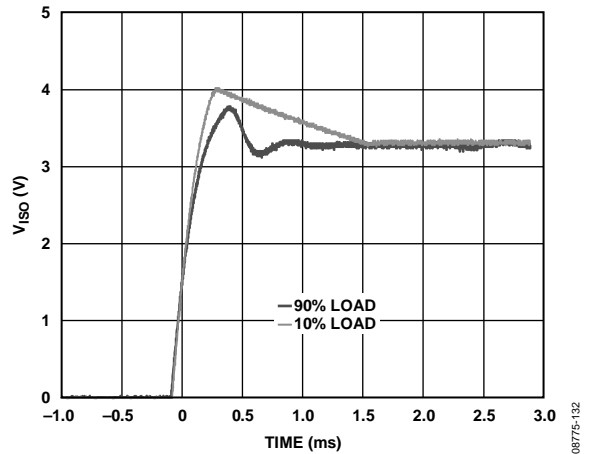

Figure 18. Typical Output Voltage Start-Up Transient at 10% and 90% Load,  $V_{ISO} = 3.3\text{ V}$

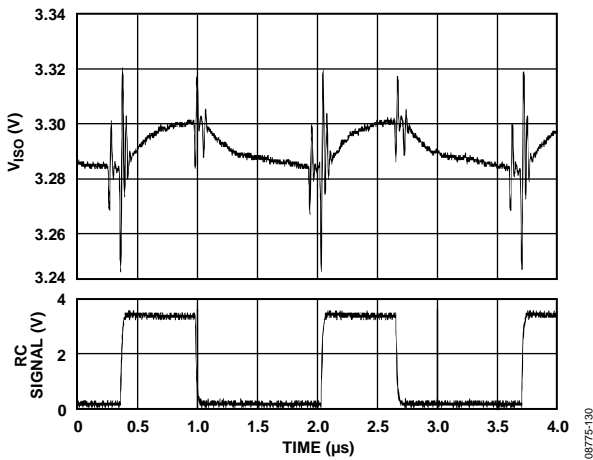

Figure 16. Typical Output Voltage Ripple at 90% Load,  $V_{ISO} = 3.3\text{ V}$

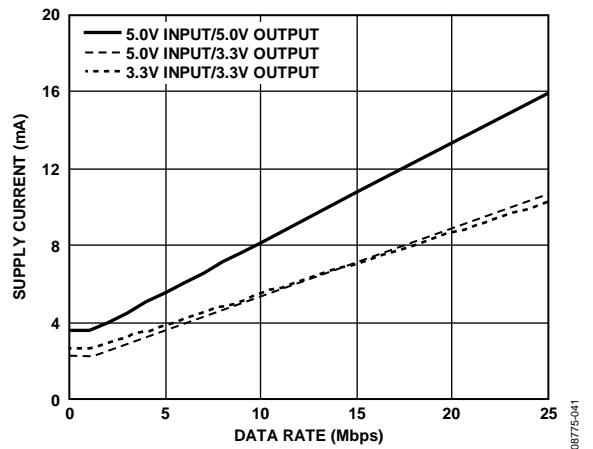

Figure 19. Typical  $I_{CHN}$  Supply Current per Forward Data Channel (15 pF Output Load)

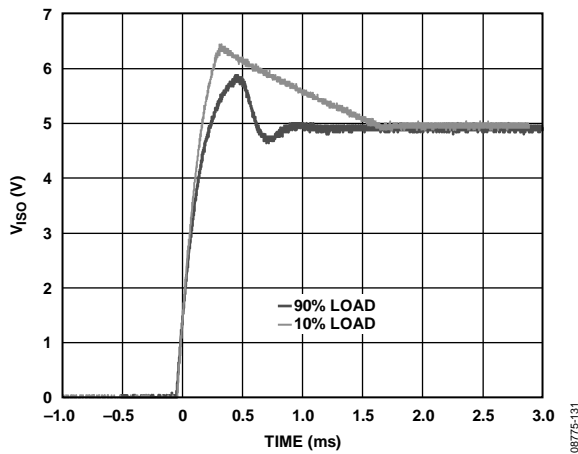

Figure 17. Typical Output Voltage Start-Up Transient at 10% and 90% Load,  $V_{ISO} = 5\text{ V}$

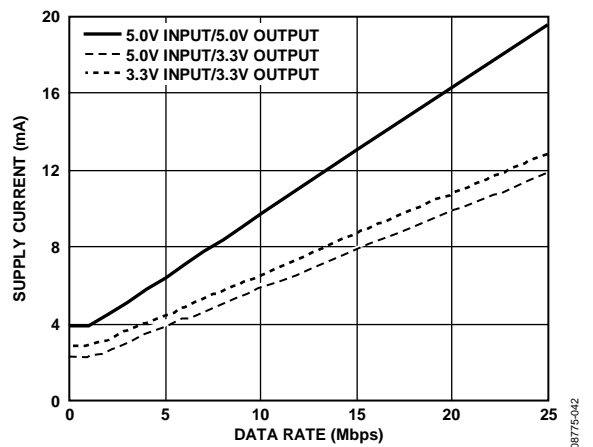

Figure 20. Typical  $I_{CHN}$  Supply Current per Reverse Data Channel (15 pF Output Load)

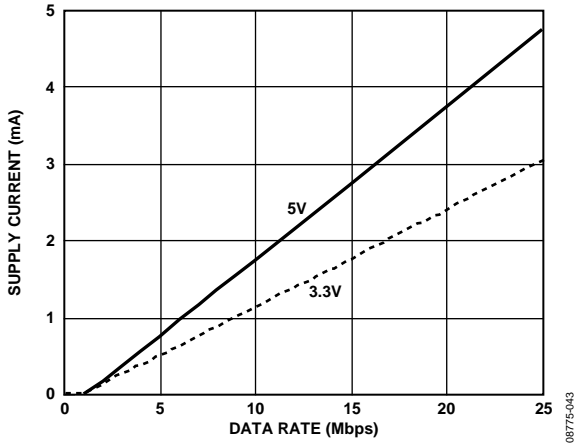

Figure 21. Typical  $I_{ISO(D)}$  Dynamic Supply Current per Input

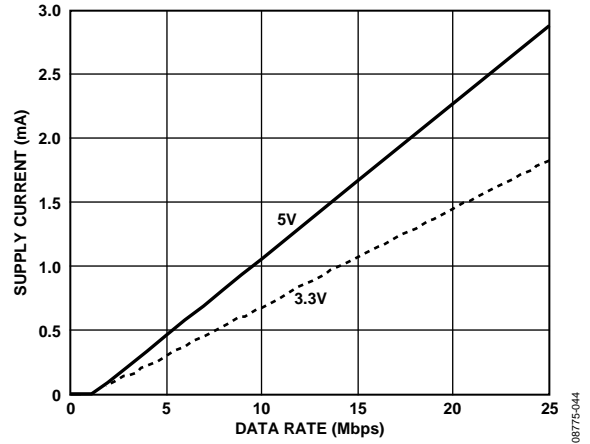

Figure 22. Typical  $I_{ISO(D)}$  Dynamic Supply Current per Output (15 pF Output Load)



## TERMINOLOGY

### $I_{DD1(Q)}$

$I_{DD1(Q)}$  is the minimum operating current drawn at the  $V_{DD1}$  pin when there is no external load at  $V_{ISO}$  and the I/O pins are operating below 2 Mbps, requiring no additional dynamic supply current.  $I_{DD1(Q)}$  reflects the minimum current operating condition.

### $I_{DD1(D)}$

$I_{DD1(D)}$  is the typical input supply current with all channels simultaneously driven at a maximum data rate of 25 Mbps with full capacitive load representing the maximum dynamic load conditions. Resistive loads on the outputs should be treated separately from the dynamic load.

### $I_{DD1(MAX)}$

$I_{DD1(MAX)}$  is the input current under full dynamic and  $V_{ISO}$  load conditions.

### $I_{ISO(LOAD)}$

$I_{ISO(LOAD)}$  is the current available to the load.

### $t_{PHL}$ Propagation Delay

The  $t_{PHL}$  propagation delay is measured from the 50% level of the falling edge of the  $V_{Ix}$  signal to the 50% level of the falling edge of the  $V_{Ox}$  signal.

### $t_{PLH}$ Propagation Delay

The  $t_{PLH}$  propagation delay is measured from the 50% level of the rising edge of the  $V_{Ix}$  signal to the 50% level of the rising edge of the  $V_{Ox}$  signal.

### Propagation Delay Skew ( $t_{PSK}$ )

$t_{PSK}$  is the magnitude of the worst-case difference in  $t_{PHL}$  and/or  $t_{PLH}$  that is measured between units at the same operating temperature, supply voltages, and output load within the recommended operating conditions.

### Channel-to-Channel Matching ( $t_{PSKCD}/t_{PSKOD}$ )

Channel-to-channel matching is the absolute value of the difference in propagation delays between two channels when operated with identical loads.

### Minimum Pulse Width

The minimum pulse width is the shortest pulse width at which the specified pulse width distortion is guaranteed.

### Maximum Data Rate

The maximum data rate is the fastest data rate at which the specified pulse width distortion is guaranteed.

## APPLICATIONS INFORMATION

The dc-to-dc converter section of the ADuM620x works on principles that are common to most switching power supplies. It has a secondary side controller architecture with isolated pulse-width modulation (PWM) feedback.  $V_{DD1}$  power is supplied to an oscillating circuit that switches current into a chip scale air core transformer. Power transferred to the secondary side is rectified and regulated to either 3.3 V or 5 V. The secondary ( $V_{ISO}$ ) side controller regulates the output by creating a PWM control signal that is sent to the primary ( $V_{DD1}$ ) side by a dedicated *iCoupler* data channel. The PWM modulates the oscillator circuit to control the power being sent to the secondary side. Feedback allows for significantly higher power and efficiency.

The ADuM620x implements undervoltage lockout (UVLO) with hysteresis on the  $V_{DD1}$  power input. This feature ensures that the converter does not enter oscillation due to noisy input power or slow power-on ramp rates.

The ADuM620x can accept an external regulation control signal ( $RC_{IN}$ ) that can be connected to other *isoPower* devices. This feature allows a single regulator to control multiple power modules without contention. When accepting control from a master power module, the  $V_{ISO}$  pins can be connected together, adding their power. Because there is only one feedback control path, the supplies work together seamlessly. The ADuM620x can only regulate itself or accept regulation (slave device) from another device in this product line; it cannot provide a regulation signal to other devices.

### PCB LAYOUT

The ADuM620x digital isolators with 0.4 W *isoPower* integrated dc-to-dc converter require no external interface circuitry for the logic interfaces. Power supply bypassing is required at the input and output supply pins (see Figure 23). Note that low ESR bypass capacitors are required between Pin 1 and Pin 2 and between Pin 15 and Pin 16, as close to the chip pads as possible.

The power supply section of the ADuM620x uses a 180 MHz oscillator frequency to pass power efficiently through its chip scale transformers. In addition, the normal operation of the data section of the *iCoupler* introduces switching transients on the power supply pins. Bypass capacitors are required for several operating frequencies. Noise suppression requires a low inductance, high frequency capacitor, whereas ripple suppression and proper regulation require a large value capacitor. These capacitors are most conveniently connected between Pin 1 and Pin 2 for  $V_{DD1}$ , and between Pin 15 and Pin 16 for  $V_{ISO}$ .

To suppress noise and reduce ripple, a parallel combination of at least two capacitors is required. The recommended capacitor values are 0.1  $\mu\text{F}$  and 10  $\mu\text{F}$  for  $V_{DD1}$  and  $V_{ISO}$ . The smaller capacitor must have a low ESR; for example, use of a ceramic capacitor is advised.

The total lead length between the ends of the low ESR capacitor and the input power supply pin must not exceed 2 mm. Installing the bypass capacitor with traces more than 2 mm in length may result in data corruption. Consider bypassing between Pin 1 and Pin 8 and between Pin 9 and Pin 16 unless both common ground pins are connected together close to the package.

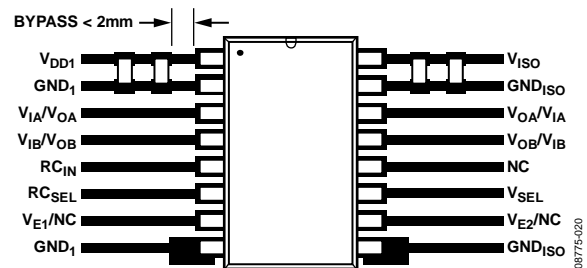

Figure 23. Recommended PCB Layout

In applications involving high common-mode transients, ensure that board coupling across the isolation barrier is minimized. Furthermore, design the board layout such that any coupling that does occur affects all pins equally on a given component side. Failure to ensure this can cause voltage differentials between pins exceeding the absolute maximum ratings for the device as specified in Table 19, thereby leading to latch-up and/or permanent damage.

The ADuM620x is a power device that dissipates approximately 1 W of power when fully loaded and running at maximum speed. Because it is not possible to apply a heat sink to an isolation device, the device primarily depends on heat dissipation into the PCB through the GND pins. If the device is used at high ambient temperatures, provide a thermal path from the GND pins to the PCB ground plane. The board layout in Figure 23 shows enlarged pads for Pin 8 ( $GND_1$ ) and Pin 9 ( $GND_{ISO}$ ). Multiple vias should be implemented from the pad to the ground plane to significantly reduce the temperature inside the chip. The dimensions of the expanded pads are at the discretion of the designer and depend on the available board space.

### START-UP BEHAVIOR

The ADuM620x devices do not contain a soft start circuit. Therefore, the start-up current and voltage behavior must be taken into account when designing with this device.

When power is applied to  $V_{DD1}$ , the input switching circuit begins to operate and draw current when the UVLO minimum voltage is reached. The switching circuit drives the maximum available power to the output until it reaches the regulation voltage where PWM control begins. The amount of current and the time required to reach regulation voltage depends on the load and the  $V_{DD1}$  slew rate.

With a fast  $V_{DD1}$  slew rate (200  $\mu\text{s}$  or less), the peak current draws up to 100 mA/V of  $V_{DD1}$ . The input voltage goes high faster than the output can turn on, so the peak current is proportional to the maximum input voltage.

With a slow  $V_{DD1}$  slew rate (in the millisecond range), the input voltage is not changing quickly when  $V_{DD1}$  reaches the UVLO minimum voltage. The current surge is approximately 300 mA because  $V_{DD1}$  is nearly constant at the 2.7 V UVLO voltage. The behavior during startup is similar to when the device load is a short circuit; these values are consistent with the short-circuit current shown in Figure 12.

When starting the device for  $V_{ISO} = 5$  V operation, do not limit the current available to the  $V_{DD1}$  power pin to less than 300 mA. The ADuM620x devices may not be able to drive the output to the regulation point if a current-limiting device clamps the  $V_{DD1}$  voltage during startup. As a result, the ADuM620x devices can draw large amounts of current at low voltage for extended periods of time.

The output voltage of the ADuM620x devices exhibits  $V_{ISO}$  overshoot during startup. If this overshoot could potentially damage components attached to  $V_{ISO}$ , a voltage-limiting device such as a Zener diode can be used to clamp the voltage. Typical behavior is shown in Figure 17 and Figure 18.

**EMI CONSIDERATIONS**

The dc-to-dc converter section of the ADuM620x devices must operate at 180 MHz to allow efficient power transfer through the small transformers. This creates high frequency currents that can propagate in circuit board ground and power planes, causing edge emissions and dipole radiation between the primary and secondary ground planes. Grounded enclosures are recommended for applications that use these devices. If grounded enclosures are not possible, follow good RF design practices in the layout of the PCB. See the AN-0971 Application Note for board layout recommendations.

**PROPAGATION DELAY PARAMETERS**

Propagation delay is a parameter that describes the time it takes a logic signal to propagate through a component. The propagation delay to a logic low output may differ from the propagation delay to a logic high output.

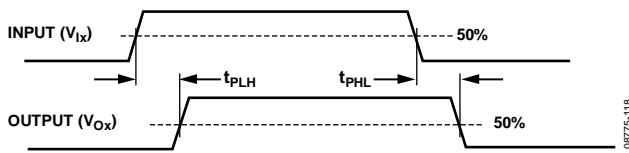

Figure 24. Propagation Delay Parameters

Pulse width distortion is the maximum difference between these two propagation delay values and is an indication of how accurately the timing of the input signal is preserved.

Channel-to-channel matching refers to the maximum amount that the propagation delay differs between channels within a single ADuM620x component.

Propagation delay skew refers to the maximum amount that the propagation delay differs between multiple ADuM620x components operating under the same conditions.

**DC CORRECTNESS AND MAGNETIC FIELD IMMUNITY**

Positive and negative logic transitions at the isolator input cause narrow (~1 ns) pulses to be sent to the decoder via the transformer. The decoder is bistable and is, therefore, either set or reset by the pulses, indicating input logic transitions. In the absence of logic transitions at the input for more than 1 μs, a periodic set of refresh pulses indicative of the correct input state is sent to ensure dc correctness at the output. If the decoder receives no internal pulses for more than approximately 5 μs, the input side is assumed to be unpowered or nonfunctional, and the isolator output is forced to a default state by the watchdog timer circuit.

The limitation on the magnetic field immunity of the ADuM620x is set by the condition in which induced voltage in the receiving coil of the transformer is sufficiently large to either falsely set or reset the decoder. The following analysis defines the conditions under which this may occur. The 3.3 V operating condition of the ADuM620x is examined because it represents the most susceptible mode of operation.

The pulses at the transformer output have an amplitude greater than 1.0 V. The decoder has a sensing threshold at approximately 0.5 V, thus establishing a 0.5 V margin in which induced voltages can be tolerated. The voltage induced across the receiving coil is given by

$$V = (-d\beta/dt) \sum \pi r_n^2; n = 1, 2, \dots, N$$

where:

$\beta$  is the magnetic flux density (gauss).

$r_n$  is the radius of the n<sup>th</sup> turn in the receiving coil (cm).

$N$  is the total number of turns in the receiving coil.

Given the geometry of the receiving coil in the ADuM620x and an imposed requirement that the induced voltage be, at most, 50% of the 0.5 V margin at the decoder, a maximum allowable magnetic field is calculated as shown in Figure 25.

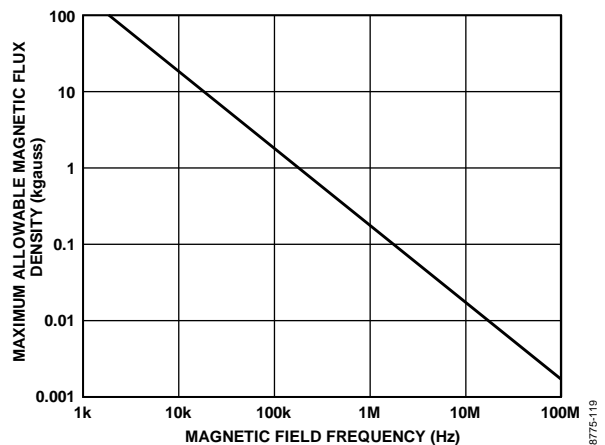

Figure 25. Maximum Allowable External Magnetic Flux Density

For example, at a magnetic field frequency of 1 MHz, the maximum allowable magnetic field of 0.2 kgauss induces a voltage of 0.25 V at the receiving coil. This voltage is approximately 50% of the sensing threshold and does not cause a faulty output transition. Similarly, if such an event occurs during a transmitted pulse (and is of the worst-case polarity), it reduces the received pulse from >1.0 V to 0.75 V—still well above the 0.5 V sensing threshold of the decoder.

The preceding magnetic flux density values correspond to specific current magnitudes at given distances from the ADuM620x transformers. Figure 26 expresses these allowable current magnitudes as a function of frequency for selected distances. As shown in Figure 26, the ADuM620x is extremely immune and can be affected only by extremely large currents operated at high frequency very close to the component. For the 1 MHz example noted, a 0.5 kA current placed 5 mm away from the ADuM620x is required to affect the operation of the device.

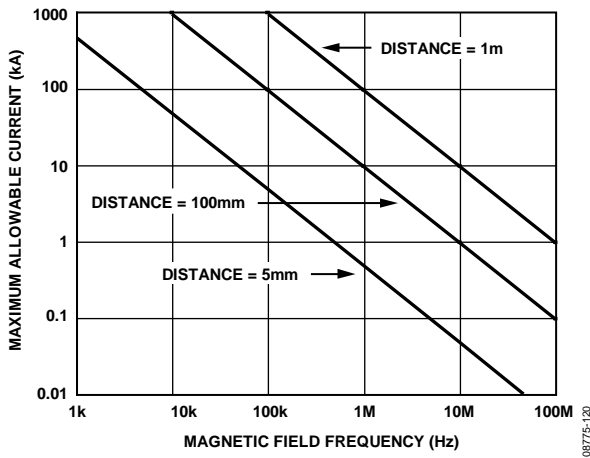

Figure 26. Maximum Allowable Current for Various Current-to-ADuM620x Spacings

Note that at combinations of strong magnetic field and high frequency, any loops formed by PCB traces can induce error voltages sufficiently large to trigger the thresholds of succeeding circuitry. Exercise care in the layout of such traces to avoid this possibility.

**POWER CONSUMPTION**

The V<sub>DD1</sub> power supply input provides power to the iCoupler data channels as well as to the power converter. For this reason, the quiescent currents drawn by the data converter and the primary and secondary input/output channels cannot be determined separately. All of these quiescent power demands are combined into the I<sub>DD1(Q)</sub> current shown in Figure 27. The total I<sub>DD1</sub> supply current is the sum of the quiescent operating current, the dynamic current I<sub>DD1(D)</sub> demanded by the I/O channels, and any external I<sub>ISO</sub> load.

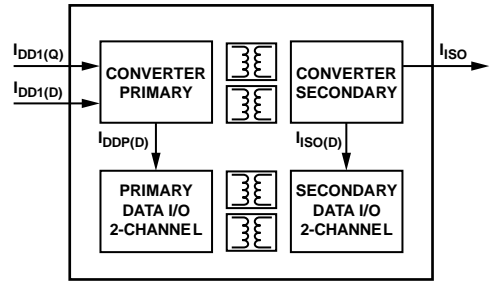

Figure 27. Power Consumption Within the ADuM620x

Both dynamic input and output current is consumed only when operating at channel speeds higher than the refresh rate, f<sub>r</sub>. Each channel has a dynamic current determined by its data rate. Figure 19 shows the current for a channel in the forward direction, which means that the input is on the primary side of the part. Figure 20 shows the current for a channel in the reverse direction, which means that the input is on the secondary side of the part. Both figures assume a typical 15 pF load. The following relationship allows the total I<sub>DD1</sub> current to be calculated:

$$I_{DD1} = (I_{ISO} \times V_{ISO}) / (E \times V_{DD1}) + \sum I_{CHn}; n = 1 \text{ to } 4 \quad (1)$$

where:

I<sub>DD1</sub> is the total supply input current.

I<sub>ISO</sub> is the current drawn by the secondary side external loads.

E is the power supply efficiency at the maximum load from Figure 9 at the V<sub>ISO</sub> and V<sub>DD1</sub> condition of interest.

I<sub>CHn</sub> is the current drawn by a single channel, determined from Figure 19 or Figure 20, depending on channel direction.

Calculate the maximum external load by subtracting the dynamic output load from the maximum allowable load.

$$I_{ISO(LOAD)} = I_{ISO(MAX)} - \sum I_{ISO(D)n}; n = 1 \text{ to } 4 \quad (2)$$

where:

I<sub>ISO(LOAD)</sub> is the current available to supply an external secondary side load.

I<sub>ISO(MAX)</sub> is the maximum external secondary side load current available at V<sub>ISO</sub>.

I<sub>ISO(D)n</sub> is the dynamic load current drawn from V<sub>ISO</sub> by an input or output channel, as shown in Figure 19 and Figure 20 for a typical 15 pF load.

This analysis assumes a 15 pF capacitive load on each data output. If the capacitive load is larger than 15 pF, the additional current must be included in the analysis of I<sub>DD1</sub> and I<sub>ISO(LOAD)</sub>.

To determine I<sub>DD1</sub> in Equation 1, additional primary side dynamic output current (I<sub>AOD</sub>) is added directly to I<sub>DD1</sub>. Additional secondary side dynamic output current (I<sub>AOD</sub>) is added to I<sub>ISO</sub> on a per-channel basis.

To determine  $I_{\text{ISO(LOAD)}}$  in Equation 2, additional secondary side output current ( $I_{\text{AOD}}$ ) is subtracted from  $I_{\text{ISO(MAX)}}$  on a per-channel basis.

For each output channel with  $C_L$  greater than 15 pF, the additional capacitive supply current is given by

$$I_{\text{AOD}} = 0.5 \times 10^{-3} \times ((C_L - 15) \times V_{\text{ISO}}) \times (2f - f_r); f > 0.5 f_r \quad (3)$$

where:

$C_L$  is the output load capacitance (pF).

$V_{\text{ISO}}$  is the output supply voltage (V).

$f$  is the input logic signal frequency (MHz); it is half the input data rate expressed in units of Mbps.

$f_r$  is the input channel refresh rate (Mbps).

## CURRENT-LIMIT AND THERMAL OVERLOAD PROTECTION

The ADuM620x is protected against damage due to excessive power dissipation by thermal overload protection circuits. Thermal overload protection limits the junction temperature to a maximum of 150°C (typical). Under extreme conditions (that is, high ambient temperature and power dissipation), when the junction temperature starts to rise above 150°C, the PWM is turned off, turning off the output current. When the junction temperature drops below 130°C (typical), the PWM turns on again, restoring the output current to its nominal value.

Consider the case where a hard short from  $V_{\text{ISO}}$  to ground occurs. At first, the ADuM620x reaches its maximum current, which is proportional to the voltage applied at  $V_{\text{DD1}}$ . Power dissipates on the primary side of the converter (see Figure 12). If self-heating of the junction becomes great enough to cause its temperature to rise above 150°C, thermal shutdown is activated, turning off the PWM and turning off the output current. As the junction temperature cools and drops below 130°C, the PWM turns on and power dissipates again on the primary side of the converter, causing the junction temperature to rise to 150°C again. This thermal oscillation between 130°C and 150°C causes the part to cycle on and off as long as the short remains at the output.

Thermal limit protections are intended to protect the device against accidental overload conditions. For reliable operation, externally limit device power dissipation to prevent junction temperatures from exceeding 130°C.

## POWER CONSIDERATIONS

The ADuM6200/ADuM6201/ADuM6202 power input, data input channels on the primary side, and data input channels on the secondary side are all protected from premature operation by undervoltage lockout (UVLO) circuitry. Below the minimum operating voltage, the power converter holds its oscillator inactive, and all input channel drivers and refresh circuits are idle. Outputs remain in a high impedance state to prevent transmission of undefined states during power-up and power-down operations.

During application of power to  $V_{\text{DD1}}$ , the primary side circuitry is held idle until the UVLO preset voltage is reached. At that time, the data channels initialize to their default low output state until they receive data pulses from the secondary side.

When the primary side is above the UVLO threshold, the data input channels sample their inputs and begin sending encoded pulses to the inactive secondary output channels. The outputs on the primary side remain in their default low state because no data comes from the secondary side inputs until secondary side power is established. The primary side oscillator also begins to operate, transferring power to the secondary power circuits.

The secondary  $V_{\text{ISO}}$  voltage is below its UVLO limit at this point; the regulation control signal from the secondary side is not being generated. The primary side power oscillator is allowed to free run under these conditions, supplying the maximum amount of power to the secondary side.

As the secondary side voltage rises to its regulation setpoint, a large inrush current transient is present at  $V_{\text{DD1}}$ . When the regulation point is reached, the regulation control circuit produces the regulation control signal that modulates the oscillator on the primary side. The  $V_{\text{DD1}}$  current is then reduced and is proportional to the load current. The inrush current is less than the short-circuit current shown in Figure 12. The duration of the inrush current depends on the  $V_{\text{ISO}}$  loading conditions and on the current and voltage available at the  $V_{\text{DD1}}$  pin.

As the secondary side converter begins to accept power from the primary, the  $V_{\text{ISO}}$  voltage starts to rise. When the secondary side UVLO is reached, the secondary side outputs are initialized to their default low state until data is received from the corresponding primary side input. It can take up to 1  $\mu\text{s}$  after the secondary side is initialized for the state of the output to correlate to the primary side input.

Secondary side inputs sample their state and transmit it to the primary side. Outputs are valid about 1  $\mu\text{s}$  after the secondary side becomes active.

Because the rate of charge of the secondary side power supply is dependent on loading conditions, the input voltage, and the output voltage level selected, take care that the design allows the converter sufficient time to stabilize before valid data is required.

When power is removed from  $V_{\text{DD1}}$ , the primary side converter and coupler shut down when the UVLO level is reached. The secondary side stops receiving power and starts to discharge.

The outputs on the secondary side hold the last state that they received from the primary side. Either the UVLO level is reached and the outputs are placed in their high impedance state, or the outputs detect a lack of activity from the primary side inputs and the outputs are set to their default low value before the secondary power reaches UVLO.

## THERMAL ANALYSIS

The ADuM620x devices consist of four internal silicon die attached to a split lead frame with two die attach paddles. For the purposes of thermal analysis, the device is treated as a thermal unit with the highest junction temperature reflected in the  $\theta_{JA}$  value from Table 14. The value of  $\theta_{JA}$  is based on measurements taken with the part mounted on a JEDEC standard 4-layer board with fine width traces and still air. Under normal operating conditions, the ADuM620x operates at full load across the full temperature range without derating the output current. However, following the recommendations in the PCB Layout section decreases the thermal resistance to the PCB, allowing increased thermal margin at high ambient temperatures.

## INCREASING AVAILABLE POWER

The ADuM620x devices are designed to work in combination with the ADuM6000 in a master/slave configuration. The RC<sub>IN</sub> and RC<sub>SEL</sub> pins allow the ADuM620x to receive a PWM signal from an ADuM6000 through its RC<sub>IN</sub> pin and to act as a slave to that control signal. The RC<sub>SEL</sub> pin chooses whether the part acts as a standalone, self-regulated device or as a slave device.

When the ADuM620x acts as a slave, its power is regulated by a PWM signal from a master device. This allows multiple *isoPower* parts to be combined in parallel while sharing the load equally. When the ADuM620x is configured as a standalone unit, it generates its own PWM feedback signal to regulate itself.

The ADuM620x devices can function as slave or standalone devices. All devices in the ADuM5xxx and ADuM6xxx family can function as standalone devices. Some of these devices also function as master devices or slave devices, but not both (see Table 25).

**Table 25. Function of *isoPower* Parts**

Part No.	Function		
	Master	Slave	Standalone
ADuM6000	Yes	Yes	Yes
ADuM620x	No	Yes	Yes
ADuM640x	No	No	Yes
ADuM5000	Yes	Yes	Yes
ADuM520x	No	Yes	Yes
ADuM5400	No	No	Yes
ADuM5401 to ADuM5404	Yes	No	Yes

Table 26 illustrates how *isoPower* devices can provide many combinations of data channel count and multiples of the single-unit power.

**Table 26. Configurations for Power and Data Channels**

Power Units	Number of Data Channels		
	0 Channels	2 Channels	4 Channels
<b>1-Unit Power</b>	ADuM6000 or ADuM5000 (standalone)	ADuM620x or ADuM520x (standalone)	ADuM5401, ADuM5402, ADuM5403, ADuM5404, or ADuM640x (standalone)
<b>2-Unit Power</b>	ADuM6000 or ADuM5000 (master) ADuM6000 or ADuM5000 (slave)	ADuM6000 or ADuM5000 (master) ADuM620x or ADuM520x (slave)	ADuM5401, ADuM5402, ADuM5403, ADuM5404 (master) ADuM6000 or ADuM5000 (slave)
<b>3-Unit Power</b>	ADuM6000 or ADuM5000 (master) ADuM6000 or ADuM5000 (slave) ADuM6000 or ADuM5000 (slave)	ADuM6000 or ADuM5000 (master) ADuM6000 or ADuM5000 (slave) ADuM620x or ADuM520x (slave)	ADuM6000 or ADuM5000 (master) ADuM620x or ADuM520x (slave) ADuM620x or ADuM520x (slave)



## INSULATION LIFETIME

All insulation structures eventually break down when subjected to voltage stress over a sufficiently long period. The rate of insulation degradation is dependent on the characteristics of the voltage waveform applied across the insulation. In addition to the testing performed by the regulatory agencies, Analog Devices carries out an extensive set of evaluations to determine the lifetime of the insulation structure within the ADuM620x devices.

Analog Devices performs accelerated life testing using voltage levels higher than the rated continuous working voltage. Acceleration factors for several operating conditions are determined. These factors allow calculation of the time to failure at the actual working voltage. The values shown in Table 20 summarize the peak voltage for 50 years of service life for a bipolar ac operating condition and the maximum CSA/VDE approved working voltages. In many cases, the approved working voltage is higher than the 50-year service life voltage. Operation at these high working voltages can lead to shortened insulation life in some cases.

The insulation lifetime of the ADuM620x devices depends on the voltage waveform type imposed across the isolation barrier. The iCoupler insulation structure degrades at different rates depending on whether the waveform is bipolar ac, unipolar ac, or dc. Figure 28, Figure 29, and Figure 30 illustrate these different isolation voltage waveforms.

Bipolar ac voltage is the most stringent environment. The goal of a 50-year operating lifetime under the bipolar ac condition determines the maximum working voltage recommended by Analog Devices.

In the case of unipolar ac or dc voltage, the stress on the insulation is significantly lower. This allows operation at higher working voltages while still achieving a 50-year service life. The working voltages listed in Table 20 can be applied while maintaining the 50-year minimum lifetime, provided that the voltage conforms to either the unipolar ac or dc voltage cases.

Any cross-insulation voltage waveform that does not conform to Figure 29 or Figure 30 should be treated as a bipolar ac waveform and its peak voltage limited to the 50-year lifetime voltage value listed in Table 20. The voltage presented in Figure 29 is shown as sinusoidal for illustration purposes only. It is meant to represent any voltage waveform varying between 0 V and some limiting value. The limiting value can be positive or negative, but the voltage cannot cross 0 V.

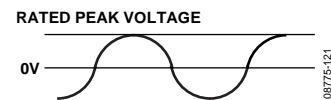

Figure 28. Bipolar AC Waveform

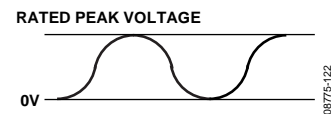

Figure 29. Unipolar AC Waveform

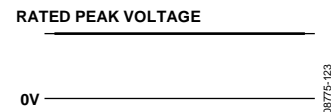
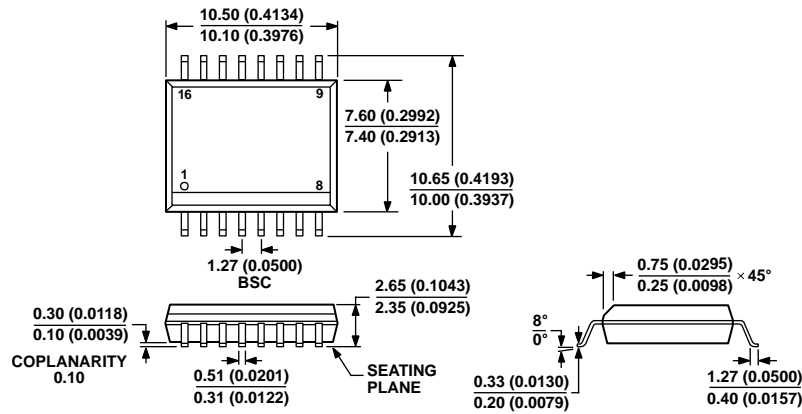

Figure 30. DC Waveform

OUTLINE DIMENSIONS



COMPLIANT TO JEDEC STANDARDS MS-013-AA  
 CONTROLLING DIMENSIONS ARE IN MILLIMETERS; INCH DIMENSIONS  
 (IN PARENTHESES) ARE ROUNDED-OFF MILLIMETER EQUIVALENTS FOR  
 REFERENCE ONLY AND ARE NOT APPROPRIATE FOR USE IN DESIGN.

03-27-2007-B

Figure 31. 16-Lead Standard Small Outline Package [SOIC\_W]  
 Wide Body  
 (RW-16)

Dimensions shown in millimeters and (inches)

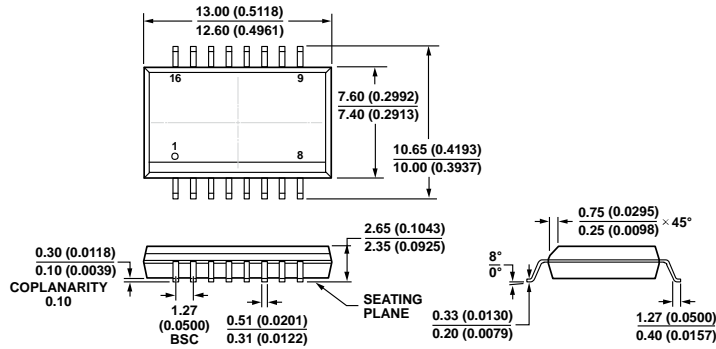

COMPLIANT TO JEDEC STANDARDS MS-013-AC  
 CONTROLLING DIMENSIONS ARE IN MILLIMETERS; INCH DIMENSIONS  
 (IN PARENTHESES) ARE ROUNDED-OFF MILLIMETER EQUIVALENTS FOR  
 REFERENCE ONLY AND ARE NOT APPROPRIATE FOR USE IN DESIGN.

16-12-2016-A

Figure 32. 16-Lead Standard Small Outline Package, with Increased Creepage [SOIC\_IC]  
 Wide Body  
 (RI-16-1)

Dimensions shown in millimeters and (inches)



## ORDERING GUIDE

Model <sup>1, 2</sup>	Number of Inputs, V <sub>DD1</sub> Side	Number of Inputs, V <sub>ISO</sub> Side	Maximum Data Rate (Mbps)	Maximum Propagation Delay, 5 V (ns)	Maximum Pulse Width Distortion (ns)	Temperature Range	Package Description	Package Option
ADuM6200ARWZ	2	0	1	100	40	–40°C to +105°C	16-Lead SOIC_W	RW-16
ADuM6200CRWZ	2	0	25	70	3	–40°C to +105°C	16-Lead SOIC_W	RW-16
ADuM6200ARIZ	2	0	1	100	40	–40°C to +105°C	16-Lead SOIC_IC	RI-16-1
ADuM6200CRIZ	2	0	25	70	3	–40°C to +105°C	16-Lead SOIC_IC	RI-16-1
ADuM6201ARWZ	1	1	1	100	40	–40°C to +105°C	16-Lead SOIC_W	RW-16
ADuM6201CRWZ	1	1	25	70	3	–40°C to +105°C	16-Lead SOIC_W	RW-16
ADuM6201ARIZ	1	1	1	100	40	–40°C to +105°C	16-Lead SOIC_IC	RI-16-1
ADuM6201CRIZ	1	1	25	70	3	–40°C to +105°C	16-Lead SOIC_IC	RI-16-1
ADuM6202ARWZ	0	2	1	100	40	–40°C to +105°C	16-Lead SOIC_W	RW-16
ADuM6202CRWZ	0	2	25	70	3	–40°C to +105°C	16-Lead SOIC_W	RW-16
ADuM6202ARIZ	0	2	1	100	40	–40°C to +105°C	16-Lead SOIC_IC	RI-16-1
ADuM6202CRIZ	0	2	25	70	3	–40°C to +105°C	16-Lead SOIC_IC	RI-16-1

<sup>1</sup> Z = RoHS Compliant Part.

<sup>2</sup> Tape and reel are available. The additional -RL suffix designates a 13-inch (1,000 units) tape and reel option.

**NOTES**

**NOTES**

NOTES