



[www.aopled.com](http://www.aopled.com)

**American Opto Plus LED Corp.**  
**Case Mold Type LED Display**  
**AOP A361LE G/W**  
**AOP C361LE G/W**

● **EDIT HISTORY**

Version A: Aug. 07, 2015

Preliminary Spec.

Manufacture	Examination	Approving



[www.aopled.com](http://www.aopled.com)

# American Opto Plus LED Corp.

## Case Mold Type LED Display

### AOP A361LE G/W

### AOP C361LE G/W

#### ● FEATURES

- 0.36 inch (9.1 mm) Digit Height.
- Low current operation.
- Case mold type.
- Gray face, White segment.
- RoHS compliant, Pb Free.

#### ● DESCRIPTION

The A361LE G/W & C361LE G/W is a 0.36 inch (9.1 mm) height single 7-segment display. This device utilizes Super Bright Red LED chip which are made from AlGaInP on a transparent GaAs substrate, The display has Gray face, White segment.

#### ● DEVICE

PART NO Super Bright Red	DESCRIPTION
A361LE G/W	Common Anode
C361LE G/W	Common Cathode

**RoHS Compliance**



**Pb free.**





[www.aopled.com](http://www.aopled.com)

# American Opto Plus LED Corp.

## Case Mold Type LED Display

### AOP A361LE G/W

### AOP C361LE G/W

#### ● MECHANICAL DIMENSIONS

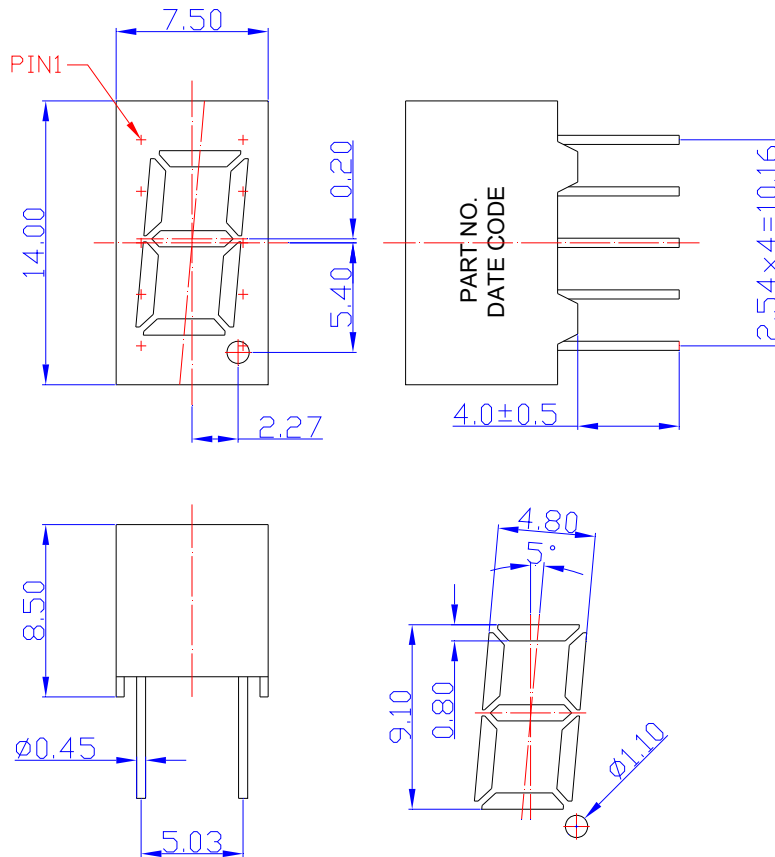

NOTES: All dimensions are in millimeters. Tolerances are  $\pm 0.25$  mm unless otherwise noted.

#### ● TYPICAL INTERNAL EQUIVALENT CIRCUIT

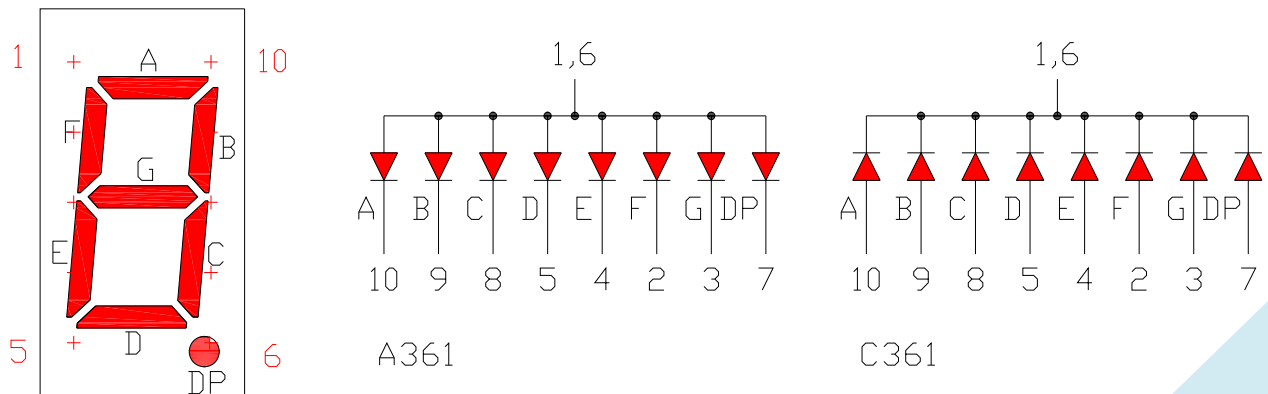



[www.aopled.com](http://www.aopled.com)

**American Opto Plus LED Corp.**  
**Case Mold Type LED Display**  
**AOP A361LE G/W**  
**AOP C361LE G/W**

● **LE: SUPER BRIGHT RED (AlGaInP/GaAs)**

ABSOLUTE MAXIMUM RATING AT Ta=25°C

Parameter	Symbol	Super Bright Red	Unit
Power dissipation per dice	P <sub>AD</sub>	70	mW
Derating liner from 25°C per dice	-	0.33	mA / °C
Continuous forward current per dice	I <sub>AF</sub>	25	mA
Peak current per dice (duty cycle 1/10, 1kHz)	I <sub>PF</sub>	90	mA
Reverse voltage per dice	V <sub>R</sub>	5	V
Operating temperature	T <sub>OPR</sub>	-25 to +85	°C
Storage temperature	T <sub>STG</sub>	-25 to +85	°C

ELECTRICAL - OPTICAL CHARACTERISTICS AT Ta=25°C

Characteristic	Symbol	Condition	Min.	Typ.	Max.	Unit
Forward voltage	V <sub>F</sub>	I <sub>F</sub> =20mA	-	2.0	2.6	V
Reverse current	I <sub>R</sub>	V <sub>R</sub> =5V	-	-	10	μA
Peak wavelength	λ <sub>P</sub>	I <sub>F</sub> =20mA	-	632	-	nm
Dominant wavelength	λ <sub>D</sub>	I <sub>F</sub> =20mA	-	625	-	nm
Luminous intensity	I <sub>v</sub>	I <sub>F</sub> =20mA	-	30	-	mcd
Spectral radiation bandwidth	Δλ	I <sub>F</sub> =20mA	-	20	-	nm



[www.aopled.com](http://www.aopled.com)

# American Opto Plus LED Corp.

## Case Mold Type LED Display

### AOP A361LE G/W

### AOP C361LE G/W

#### ● LE: SUPER BRIGHT RED (AlGaInP/GaAs) CURVE

Typical Electro-optical Characteristic Curves  
(25 °C Free Air Temperature Unless Otherwise Specified)

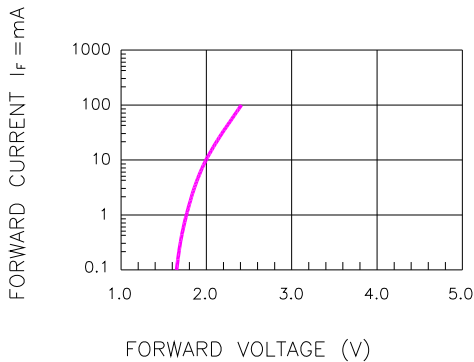

Fig.1 FORWARD CURRENT VS. FORWARD VOLTAGE

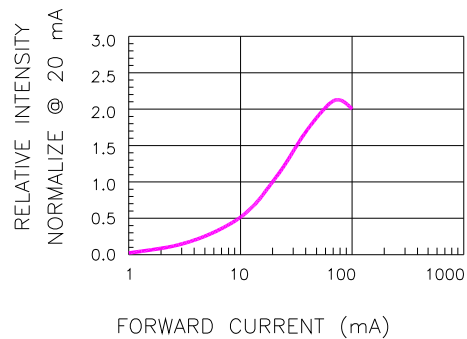

Fig.2 RELATIVE INTENSITY VS. FORWARD CURRENT

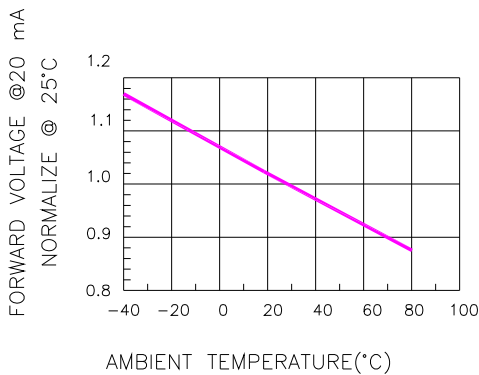

Fig.3 FORWARD VOLTAGE VS. TEMPERATURE

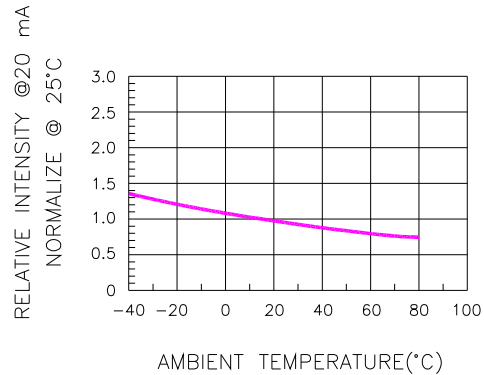

Fig.4 RELATIVE INTENSITY VS. TEMPERATURE

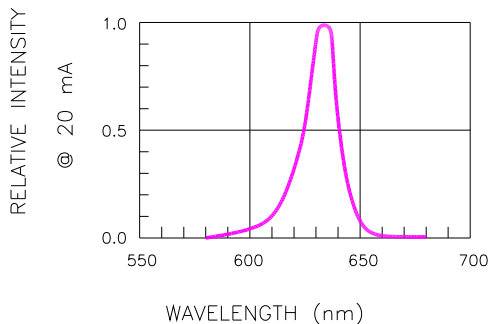

Fig.5 RELATIVE INTENSITY VS. WAVELENGTH

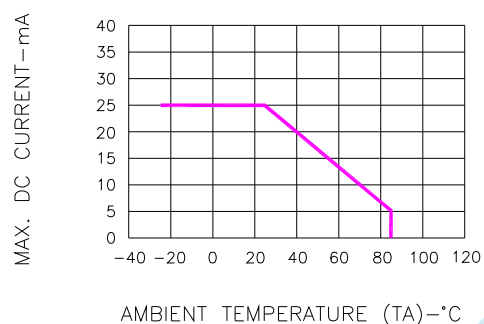

Fig.6 MAX. ALLOWABLE DC CURRENT VS. AMBIENT TEMPERATURE



[www.aopled.com](http://www.aopled.com)

# American Opto Plus LED Corp.

## Case Mold Type LED Display

### AOP A361LE G/W

### AOP C361LE G/W

## ● RECOMMEND SOLDERING PROFILE

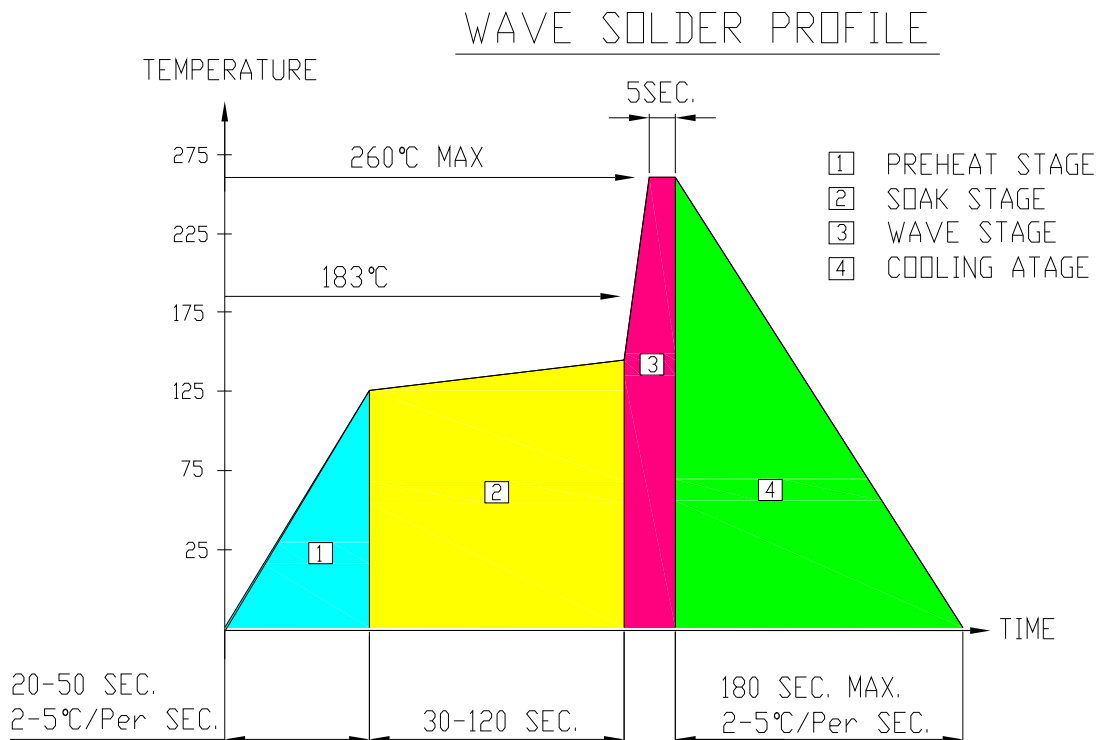

## ● Note:

- Recommend pre-heat temperature of 105°C or less (as measured with a thermocouple attached to the LED pins) prior to immersion in the solder wave with a maximum solder bath temperature of 260°C
- Peak wave soldering temperature between 245°C ~ 225°C for 3 sec (5 sec max)
- No more than one wave soldering pass

## ● SOLDERING IRON

Basic spec is  $\leq 4$  sec when 260°C. If temperature is higher, time should be shorter (+10°C → 1 sec). Power dissipation of Iron should be smaller than 15W, and temperature should be controllable. Surface temperature of the device should be under 230°C.

## ● REWORK

Customer must finish rework within  $\leq 3$  sec under 350°C.  
The head of soldering iron cannot touch copper foil.