



Features

- One pole flux relay with AgSnO contacts satisfice inrush current 111A/20ms
- 16A high switching capacity
- Small size and 15.7mm high
- 5KV dielectric between coil and contact withstand surge voltage of 10KV
- Several contact types available
- Creepage and clearance distance between coil and contacts $\geq 10\text{mm}$
- Compliance with IEC60335-1 GWIF850°C/GWIT775°C CTI $\geq 250\text{V}$.
- Satisfice IEC60079-15 product is available.

Safety Approval

UL, C-UL File No.: E190598

VDE File No.: 40031353

CQC File No.: CQC10002049463

Contact Capacity

Model	SM-1Pole	SM-2Poles
Nominal switching capacity (res. load)	16A 250VAC/12A250VAC	8A 250VAC
Max. switching current	20A	10A
Max. switching voltage	277VAC	277VAC
Max. switching power	4,000VA/3,000VA	2,770VA

Characteristic Data

Contact material	Silver alloy	
Initial contact resistance	100m Ω Max. (1A 6VDC)	
Operate time (at nominal volt.)	15msec. Max. (no diode)	
Release time (at nominal volt.)	10msec. Max. (no diode)	
Initial insulation resistance	1000M Ω Min.(DC500V)	
Initial dielectric strength	Between open contacts: AC1,000V, 50/60Hz 1Min.	
	Between coil and contact: AC5,000V, 50/60Hz 1Min.	
	Between contact sets: AC2,500V, 50/60Hz 1Min.	
Vibration resistance	Functional	10 ~ 55Hz at double amplitude of 1.5 mm
	Destructive	10 ~ 55Hz at double amplitude of 1.5 mm
Shock resistance	Functional	10GMin.
	Destructive	100GMin.
Endurance (operations)	Mechanical (at10,800 ops./h)	10,000,000 (at room temperature)
	Electrical (at 360 ops./h)	100,000 (at room temperature)
Ambient temperature	-40°C ~ + 85 °C (no condensation)	
Unit weight	Approx. 13.5 g	

Coil Data (at 20°C)

Norminal Voltage (VDC)	Norminal operating current 10%(mA)	Coil resistance 10%(m Ω)	Max. allowable voltage	Pick-up voltage (Max.)	Drop-out voltage (Min.)	Norminal operating power
5	81.00	63	150 % of nominal voltage	75 % of nominal voltage	10 % of nominal voltage	Approx. 0.4W
6	67.00	90				
9	45.00	203				
12	33.00	360				
15	26.00	562				
18	22.00	810				
24	17.00	1440				
48	8.00	5760				
60	6.70	8570				
110	3.60	28800				

Safety Approval Ratings

(Note: More detail of approval ratings, please refer to the safety certification)

Approval	CQC	VDE	UL
File No.	CQC10002049463	40031353	E190598
Approved ratings	1Pole: 16A 250VAC 12A 250VAC 2Poles: 8A 250VAC	1Pole: 16A 250VAC 12A 250VAC 10A 250VAC 2Poles: 8A 250VAC	1Pole(16A): 16A 250VAC, Resistive&G.P. 20A 277VAC, Resistive&G.P. 1HP, 480/240VAC 1/2HP, 120VAC 10FLA/60LRA, 240VAC PilotDuty: A300360VA, 120VAC 1Pole(12A): 12A 250VAC, Resistive&G.P. 10A 277VAC, Resistive&G.P. 3/4HP, 3.5FLA, 480VAC 1/2HP, 4.9FLA, 240VAC 1/3HP, 120VAC 10FLA/48LRA, 240VAC PilotDuty: A300360VA, 120VAC 2Poles: 10A 250VAC, Resistive&G.P. 8A 277VAC, Resistive&G.P. 10A 30VDC, Resistive&G.P. 8A 30VDC, Resistive&G.P. 1/2HP, 240VAC 1/4HP, 120VAC 6FLA/34.8LRA, 120VAC 5FLA/17.4LRA, 240VAC PilotDuty: B300

- (1) The above-mentioned unspecified temperature ratings, means that the ambient temperature is room temperature.
- (2) Only some typical ratings are listed above. Each rating's test condition is different, so the electrical endurance will be different. If more details are required, please contact us.
- (3) For sealed type testing, please open the ventilation hole of case before test.

Ordering Information

Nomenclature										
SM	-S	-1	12	D	M	H	1-	F-	XX	Special Parameter: Nil-Standard type, Letter or number-Special requirement
									Insulation System: Nil-Standard, B-Class B, F-Class F	
									Contact Material : Nil-AgNi, 1-AgSnO ₂ , 2-AgSnO ₂ and AgNi	
									Contact Capacity: Nil-1 pole, 16A, 5.0mm pinning or 2 poles, 8A, 5.0mm pinning; H-1 pole, 12A, 5.0mm pinning; T-1 pole, 12A, 3.5mm pinning	
									Contact Form: Nil-Form C, M-Form A	
									Coil Power: D-0.4W	
									Coil Voltage(VDC): 05, 06, 09, 12, 15, 18, 24, 48, 60, 110	
									Number of Poles: 1-1 Pole, 2-2 Poles	
									Protective Construction: S-Flux proofed SH-Sealed type washable	
									Type Designation: SM	

Outline Dimensions, Wiring Diagram, P.C. Board Layout (unit: mm)

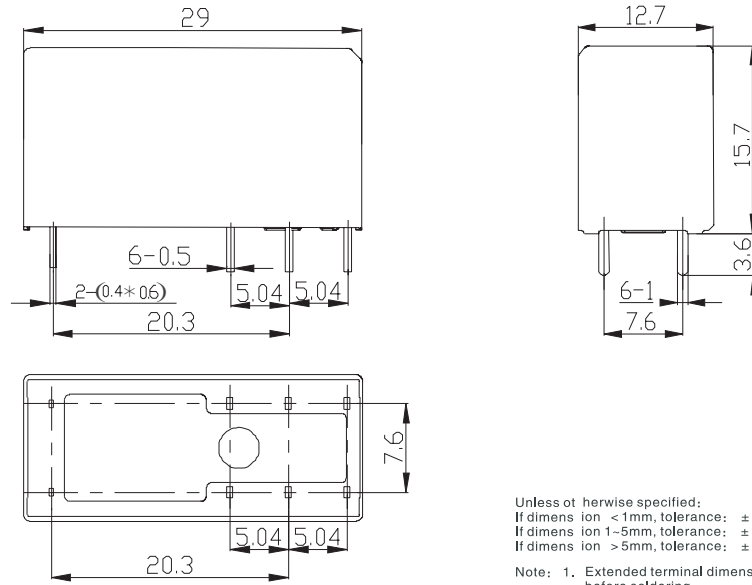

Unless otherwise specified:
 If dimension < 1mm, tolerance: $\pm 0.2\text{mm}$;
 If dimension 1-5mm, tolerance: $\pm 0.3\text{mm}$;
 If dimension > 5mm, tolerance: $\pm 0.4\text{mm}$.

Note: 1. Extended terminal dimension is dimension before soldering.
 2. Tolerance of P.C.B. layout: $\pm 0.1\text{mm}$.

2 Poles, 8A
5.0mm pinning

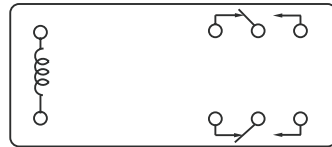

1 Pole, 16A
5.0mm pinning

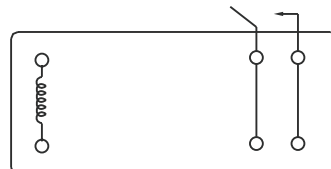
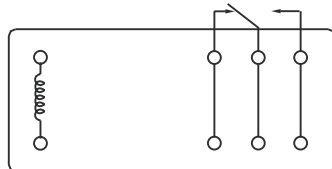

1 Pole, 12A
5.0mm pinning

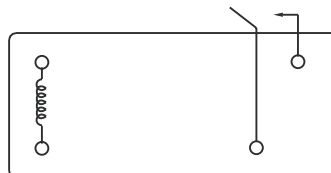
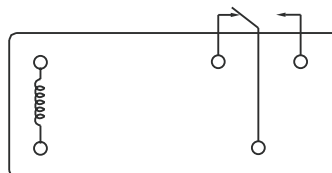

1 Pole, 12A
3.5mm pinning

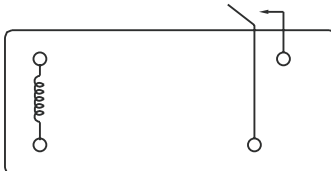
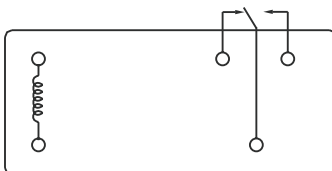

Wiring Diagram (bottom view)

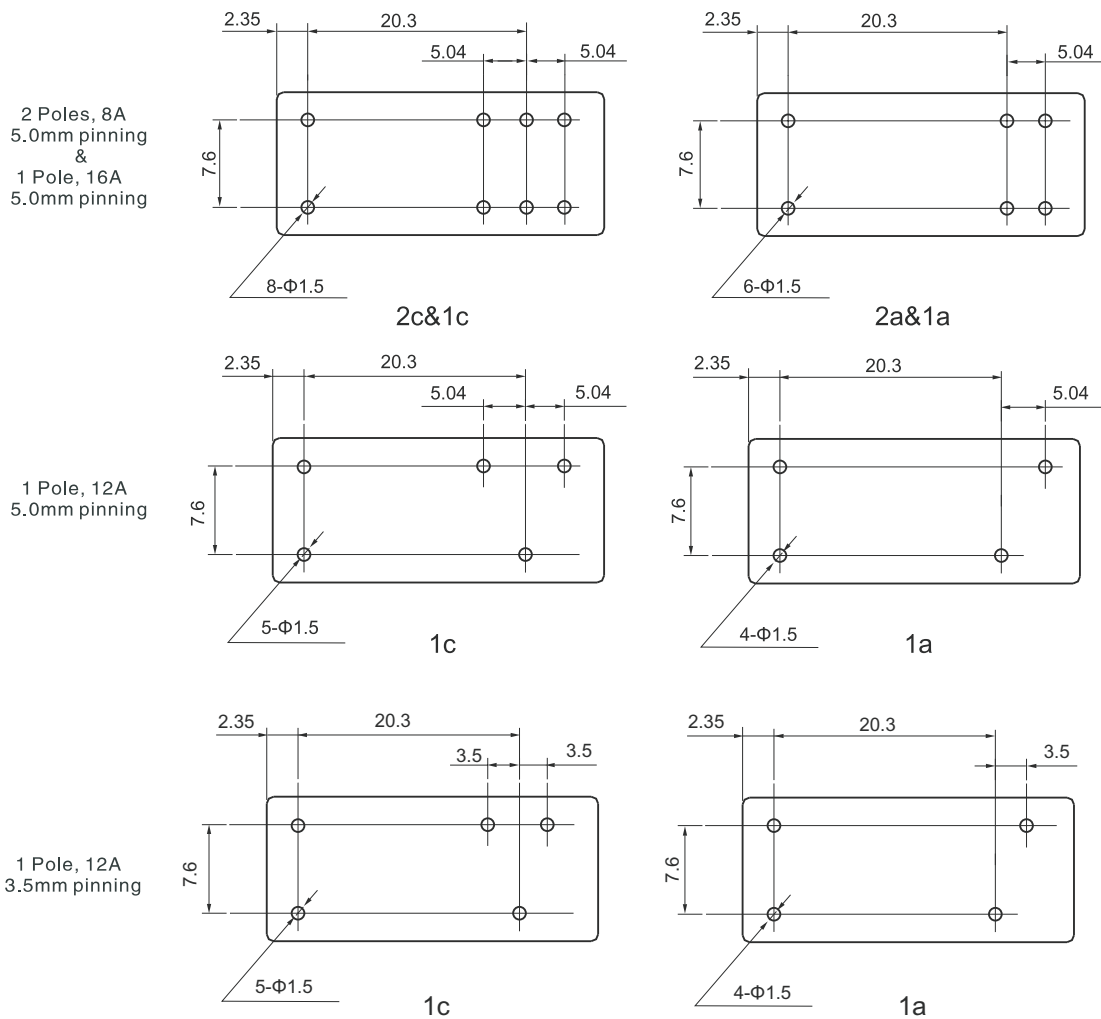

P.C.B. Layout (bottom view)

Typical Applications

- Home appliances, washing machine, air conditioner, microwave oven, audio equipment, monitor, industrial control equipment, instrument, etc.

Characteristic Curves

Maximum Switching Power

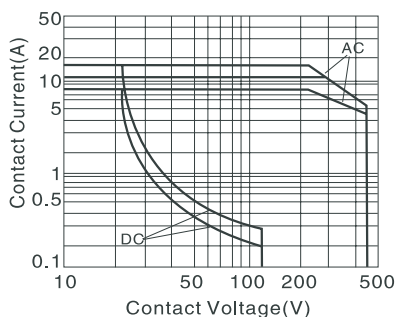

Endurance Curve

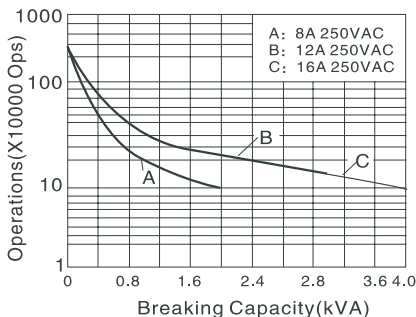

Coil Operating Range

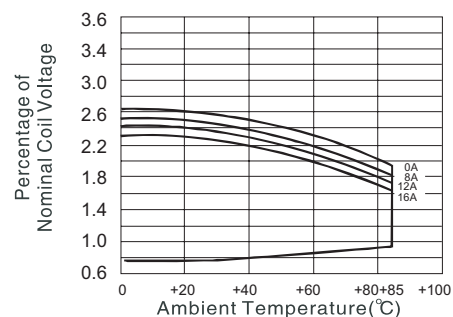

Disclaimer:

This datasheet is the customers' reference. All the specification are subject to change without notice. We could not evaluate all the performance and all the parameters for every possible application. Thus the user should in a right position to choose the suitable product for their own application. For sealed relays after installation and cleaning, please open the vent hole on the case before use. If there is any query, please contact Sanyou for the technical service. However it is the user's responsibility to determine which product should be used only.