

# LT8386

## 60V, 3A Silent Switcher Synchronous Step-Up LED Driver

### DESCRIPTION

Demonstration circuit DC3008A is a 60V 3A Silent Switcher synchronous step-up LED driver featuring the [LT<sup>®</sup>8386](#). It drives a single string of LEDs at 500mA up to 45V when  $V_{IN}$  is between 4V and 40V. It runs down to  $4V_{IN}$  with reduced  $I_{LED}$  and can withstand  $V_{IN}$  as high as 50V, but has overvoltage lockout (OVLO) set for 45V for this application. DC3008A runs at 340kHz switching frequency. Spread spectrum frequency modulation (SSFM) can be turned on with a simple jumper, reducing EMI. DC3008A comes with low EMI features including optimized layout, SSFM and input EMI filter.

It is protected against both open and short LED conditions and reports the faults. The LT8386 boost converter has an input voltage range from 4V to 56V. Its internal synchronous 3.3A 60V switches allow up to 52V of LEDs (with adjusted FB resistors) on the output with room for over voltage protection and overshoot during an open LED event. It has adjustable switching frequency between 200kHz and 2MHz. It can be synchronized to an external source or programmed with SSFM for low EMI. The PWMTG high-side PWM MOSFET driver assists with short-circuit protection and versatility. LT8386 can be configured as a boost, boost-buck, or buck mode LED driver and maintain all of its low EMI, PWM dimming, and fault diagnostic features.

The LT8386 can be PWM dimmed with an external PWM signal or an internally-generated PWM signal. DC3008A has a jumper that can be set to switch between internally-generated PWM signal, externally-generated PWM signal,

and no PWM signal (100% ON). It can be analog dimmed with a control voltage on its control pin (CTRL).

When run with both PWM dimming and SSFM, the SSFM aligns itself with the PWM signal for flicker-free operation.

Small ceramic input and output capacitors are used to save space and cost. The board is designed with small, high frequency capacitors on both sides of the VOUT pins for a reduction in emissions. The open LED overvoltage protection uses the IC's constant voltage regulation loop to regulate the output to approximately 57V if the LED string is opened. The output current can be monitored through the ISMON test point.

Undervoltage and overvoltage lockout can be adjusted on the circuit with a few simple resistor choices. There is an EMI filter on the input of DC3008A. Please follow the recommend layout and four-layer thickness of DC3008A for low EMI applications.

The LT8386 data sheet gives a complete description of the part, operation and applications information. The data sheet must be read in conjunction with this demo manual for demonstration circuit DC3008A. The LT8386JV is assembled in a 28-lead plastic 4mm x 5mm LQFN package with a thermally-enhanced GND pad. Proper board layout is essential for maximum thermal performance. See the data sheet section Layout Considerations.

**[Design files for this circuit board are available.](#)**

All registered trademarks and trademarks are the property of their respective owners.

# DEMO MANUAL DC3008A

## PERFORMANCE SUMMARY Specifications are at $T_A = 25^\circ\text{C}$

PARAMETER	CONDITIONS	MIN	TYP	MAX	UNITS
Input Voltage $V_{IN}$ Range	Operating, $I_{LED} > 0\text{mA}$	4.0		40	V
Input Voltage $V_{IN}$ Range	Operating, $V_{LED} = 45\text{V}$ , $I_{LED} = 500\text{mA}$	8		45	V
Safe Input Voltage $V_{IN}$ Range		0		50	V
$V_{IN}$ Undervoltage Lockout (UVLO) Falling	Operating, $V_{LED} = 45\text{V}$ , $I_{LED} = 500\text{mA}$		4.3		V
$V_{IN}$ Enable Turn-On (EN) Rising			6.4		V
OVLO Over Voltage Lockout $V_{IN}$			45		V
Switching Frequency ( $f_{SW}$ )	$R2 = 294\text{k}\Omega$ , SSFM = OFF		340		kHz
	$R2 = 294\text{k}\Omega$ , SSFM = ON		340-430		kHz
LED Current $I_{LED}$	$R1 = 0.20\Omega$ , $8\text{V} < V_{IN} < 40\text{V}$ $V_{LED} = 45\text{V}$ , $V_{CTRL} = 2\text{V}$		500		mA
LED Voltage $V_{LED}$ range	$R4 = 1\text{M}\Omega$ , $R5 = 22.1\text{k}\Omega$	$V_{IN}$		46	V
Open LED Voltage $V_{OUT}$	$R4 = 1\text{M}\Omega$ , $R5 = 22.1\text{k}\Omega$		57		V
Efficiency (100% PWM DC)	12.0V $V_{IN}$ , 330kHz, 45V LEDs SSFM = OFF		93		%
Internally-Generated PWM Dimming Range	Operating, JP1 = INT, JP2 = INT $R10 = 118\text{k}\Omega$	1/512		100%	
Internally-Generated PWM Dimming Frequency			160		Hz

## BOARD PHOTO

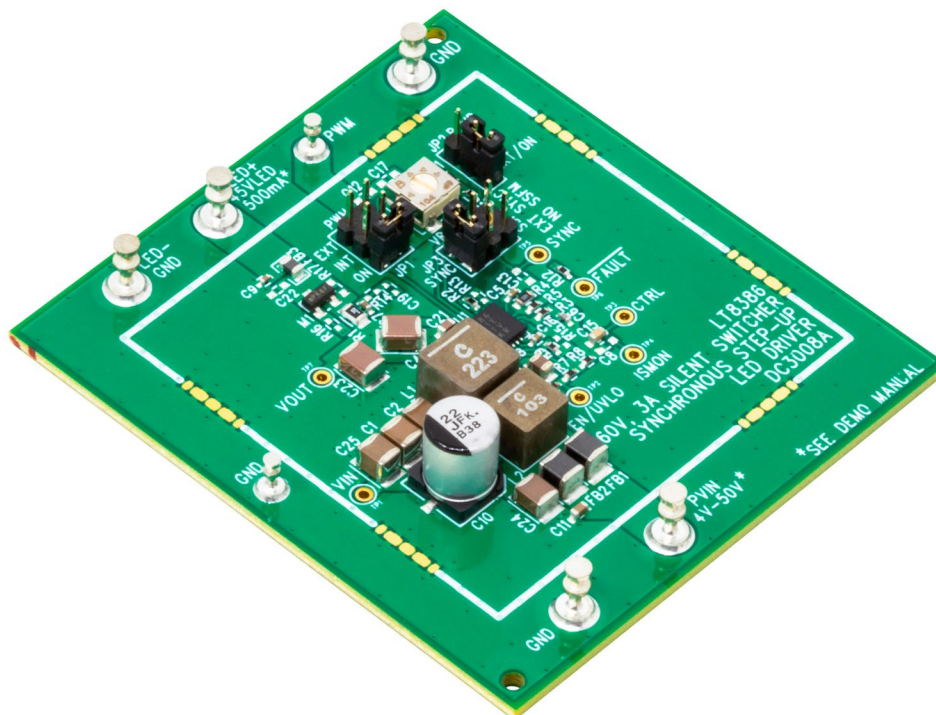

## QUICK START PROCEDURE

**NOTE:** Make sure that the voltage applied to  $V_{IN}$  does not exceed 50V.

The DC3008A is easy to set up to evaluate the performance of the LT8386. Refer to Figure 1 for proper measurement equipment setup and follow the procedure below.

1. With power off, connect a string of one or two LEDs that runs with a forward voltage less than or equal to 45V at 500mA to the LED<sup>+</sup> and LED<sup>-</sup> GND terminals.
2. Connect the EN/UVLO terminal to GND.
3. For always-on LED operation: Set JP1 to "ON" and JP2 to "EXT/ON".
4. With power off, connect the input power supply to the  $V_{IN}$  and GND terminals.
5. Turn the input power supply on and make sure the voltage is between 4V and 45V to start operation.
6. Release the EN/UVLO-to-GND connection.
7. Observe the LED string running at the programmed LED current.
8. To change the brightness with **analog dimming**, simply attach a voltage source to the CTRL test point and set the voltage between 0V and 2V. See data sheet for details.
9. To change brightness with **internally-generated PWM dimming**, change the JP1 and JP2 jumpers to "INT". Adjust the voltage of the PWM pin by changing the position of the VR1 potentiometer.
10. To change brightness with **external PWM dimming**, set JP1 to "EXT" and JP2 to "EXT/ON". Keep LED wire length to a minimum to achieve the highest dimming ratios. Attach a 0V-3V rectangular waveform with varying duty cycle to the PWM test point.
11. To enable **spread spectrum frequency modulation**, set JP3 to "SSFM". Setting JP3 to "NO SSFM" turns off SSFM. Setting JP3 to "SYNC" connects the pin to the SYNC test point. The converter can be synchronized to an external clock by connecting one to the SYNC test point in this setting. Please see the datasheet for details.

**QUICK START PROCEDURE**

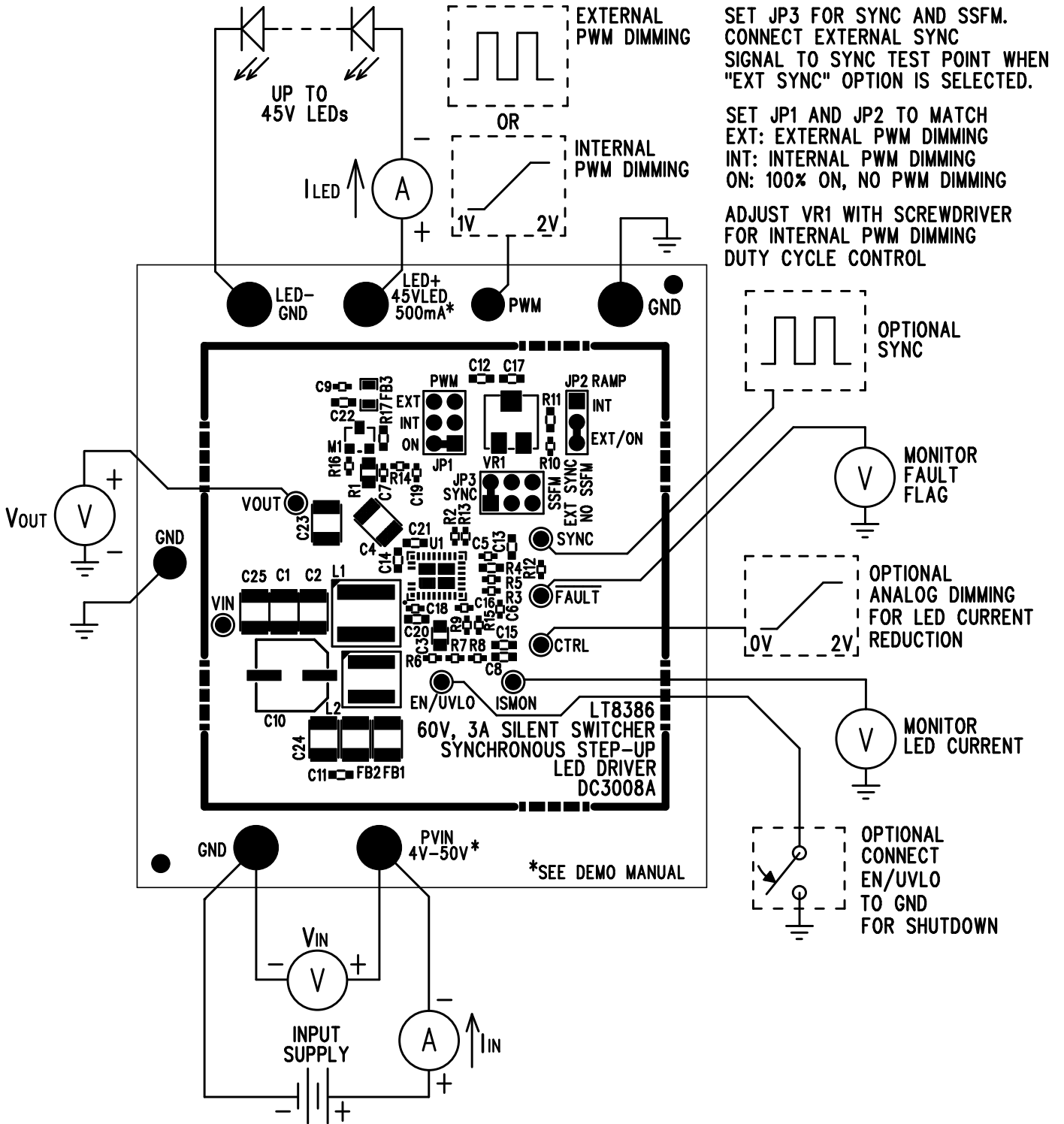

Figure 1. Test Procedure Setup Drawing for DC3008A

TEST RESULTS

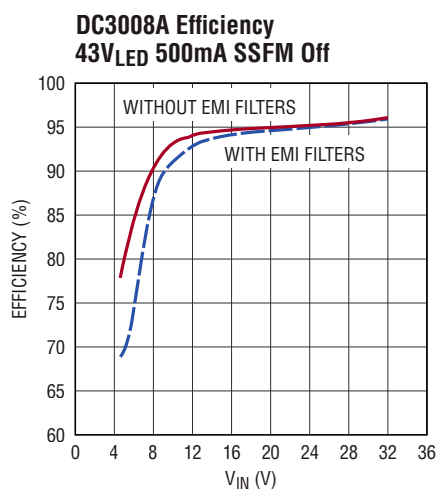

Figure 2. DC3008A efficiency with and without EMI filters. DC3008A is assembled with EMI filters.

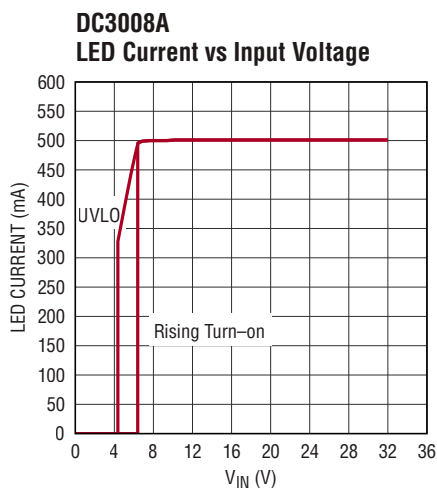

Figure 3. DC3008A 43V<sub>LED</sub> string - I<sub>LED</sub> v. V<sub>IN</sub>. Below 7V<sub>IN</sub>, I<sub>LED</sub> scales back based upon I<sub>SWPK</sub>.

## TEST RESULTS

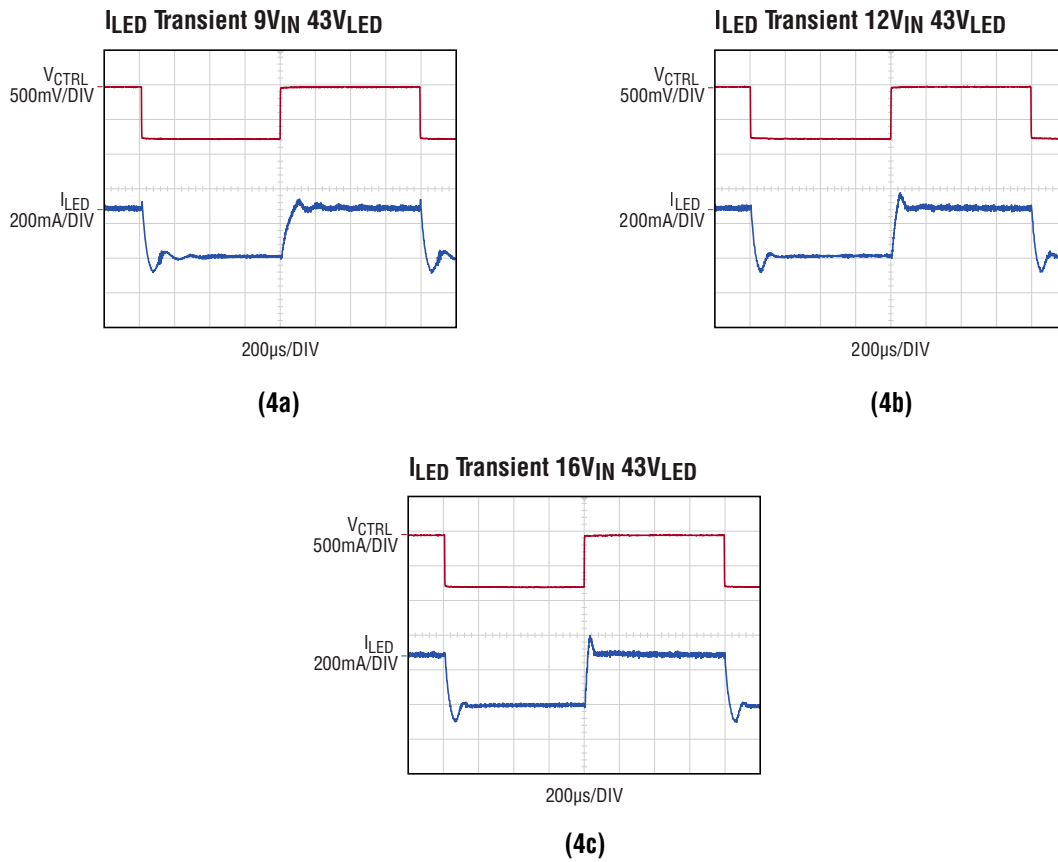
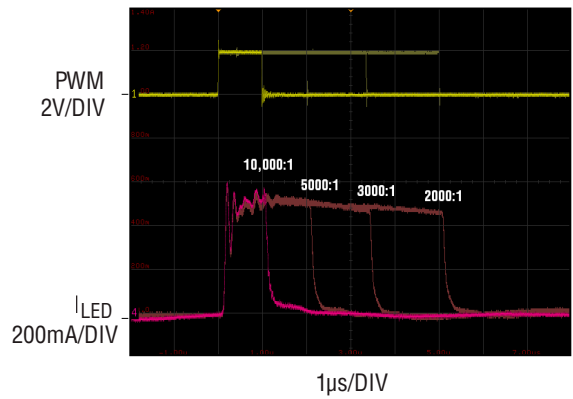
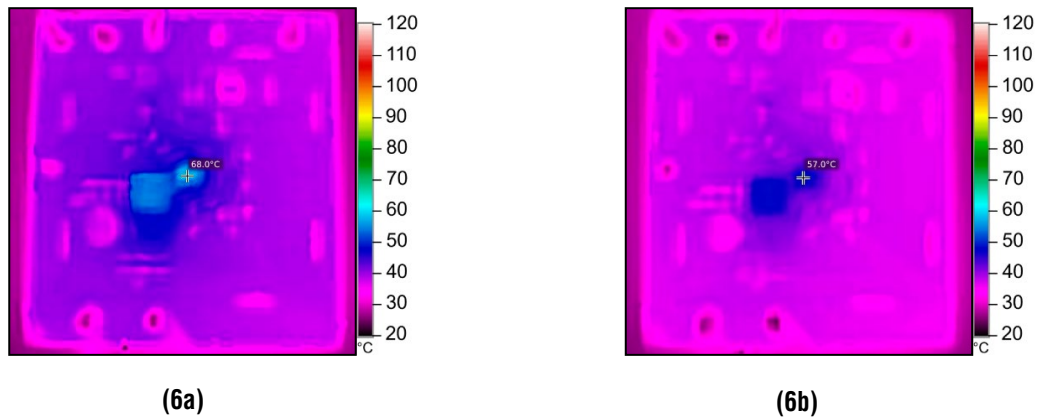

Figure 4. DC3008A I<sub>LED</sub> Load Transient with CTRL Input with SSFM OFF, I<sub>LED</sub> transient is between 200mA and 500mA using a voltage input to the CTRL pin.

**TEST RESULTS**

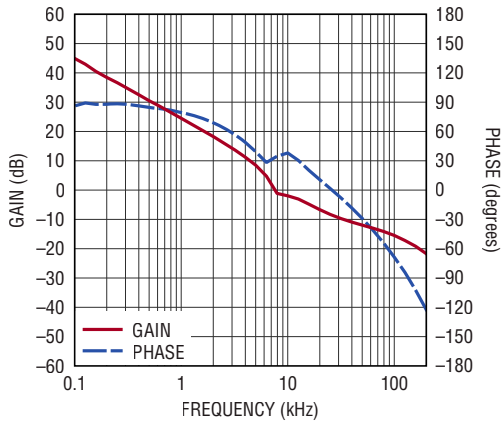

**Figure 5. The LT8386 can achieve dimming ratios of 10000:1 at 100Hz with an EMI filter on the output. With the output EMI filter removed, the LT8386 can achieve 25,000:1 or higher PWM dimming ratio.**

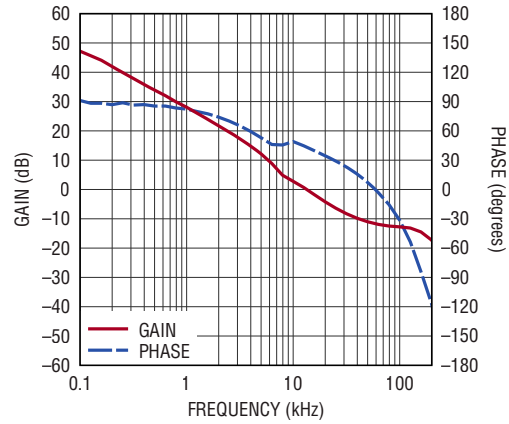

**Figure 6. DC3008A LT8386 thermal image with 500mA, 45V LEDs, SSFM ON, and (a) 9V<sub>IN</sub>, (b) 12V<sub>IN</sub>**

## TEST RESULTS



(7a)



(7b)

Figure 7. DC3008A bode plots with 43V, 500mA LED string (a) 12V<sub>IN</sub> and (b) 9V<sub>IN</sub>

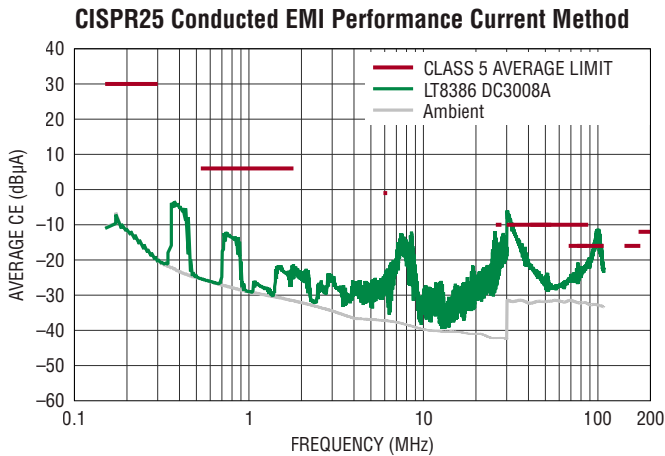

(8a)

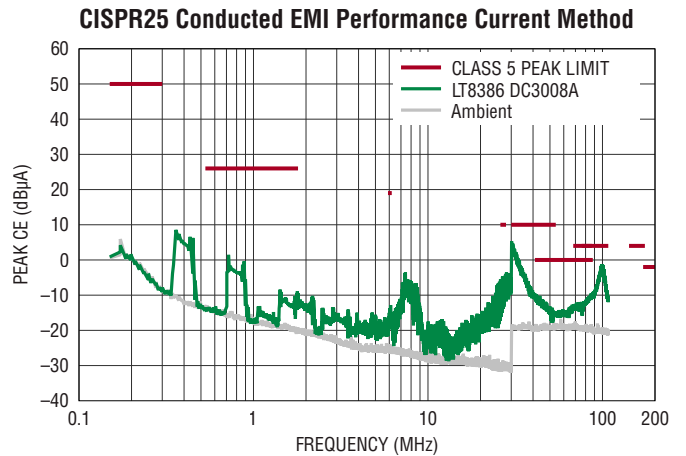

(8b)

Figure 8. Average and Peak Conducted Emissions Performance Using Current Method with CISPR25 Class 5 Limits. Addition of the shield can reduce CE average from 30MHz to 108MHz further below the limits. 14V<sub>IN</sub>, 43V<sub>LED</sub>, 500mA, SSFM ON, with no ferrite clamp on output cables to LEDs



TEST RESULTS

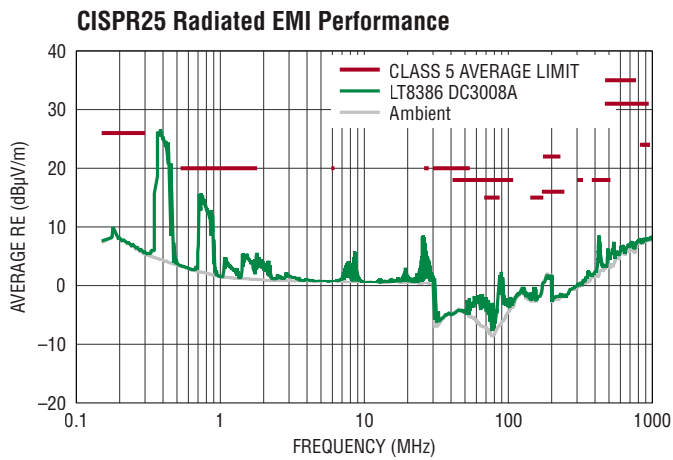

(9a)

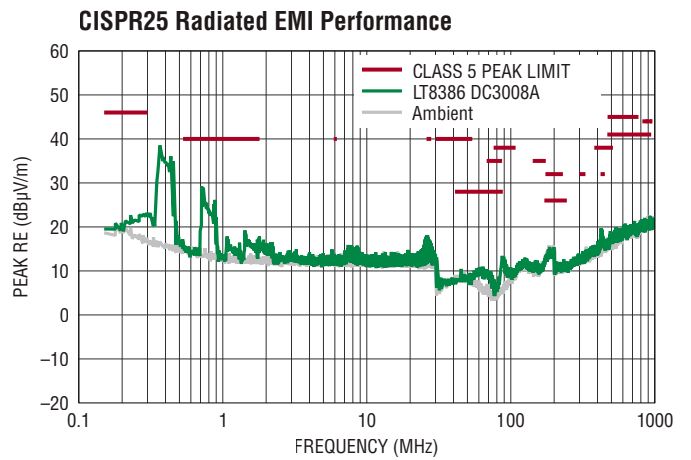

(9b)

Figure 9. Average and Peak Conducted Emissions Performance Using Voltage Method with CISPR25 Class 5 Limits. For reduced AM band CE results, use a larger L2, C10, or C24, or add on the EMI shield. 14V<sub>IN</sub>, 43V<sub>LED</sub>, 500mA, SSFM ON, with no ferrite clamp on output cables to LEDs

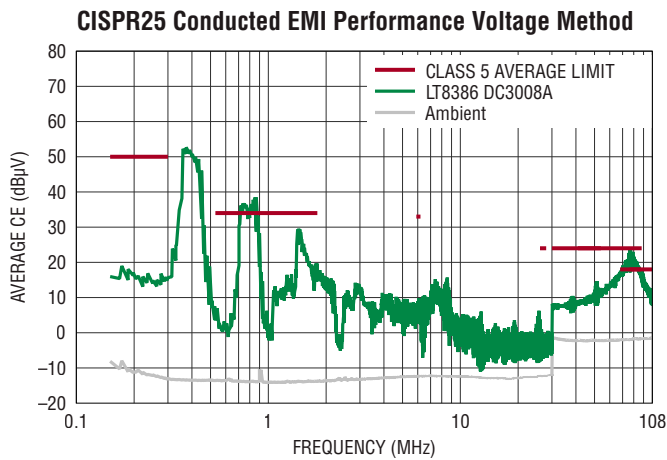

(10a)

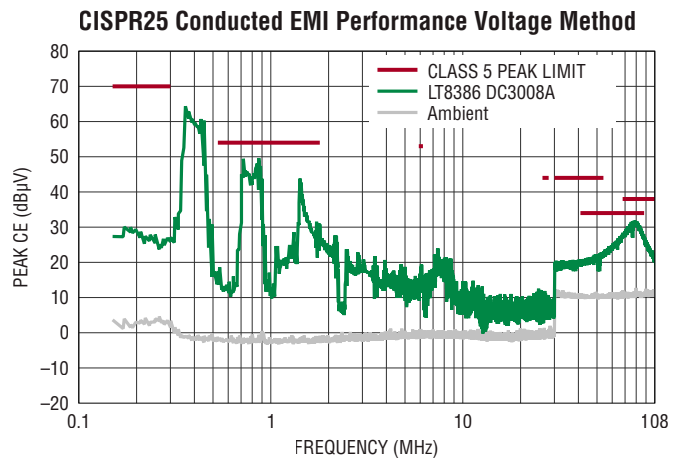

(10b)

Figure 10. Average and Peak Radiated Emissions Performance with CISPR25 Class 5 Limits. DC3008A passes all radiated emissions without requiring the EMI shield. 14V<sub>IN</sub>, 43V<sub>LED</sub>, 500mA, SSFM ON, with no ferrite clamp on output cables to LEDs

## EMISSIONS SHIELD (OPTION)

For the ultimate lowest emissions, an EMI shield can be attached to DC3008A. The PCB was fabricated with placeholders for six shield clips which can hold a 44mm x 44mm metal shield. Part numbers for an example shield are provided in the Parts List below in the Hardware list.

The top silkscreen picture (Figure 11) shows the placeholders for the six surface mount shield clips. Then the emissions of the board can be tested with and without the removable clip-shield.

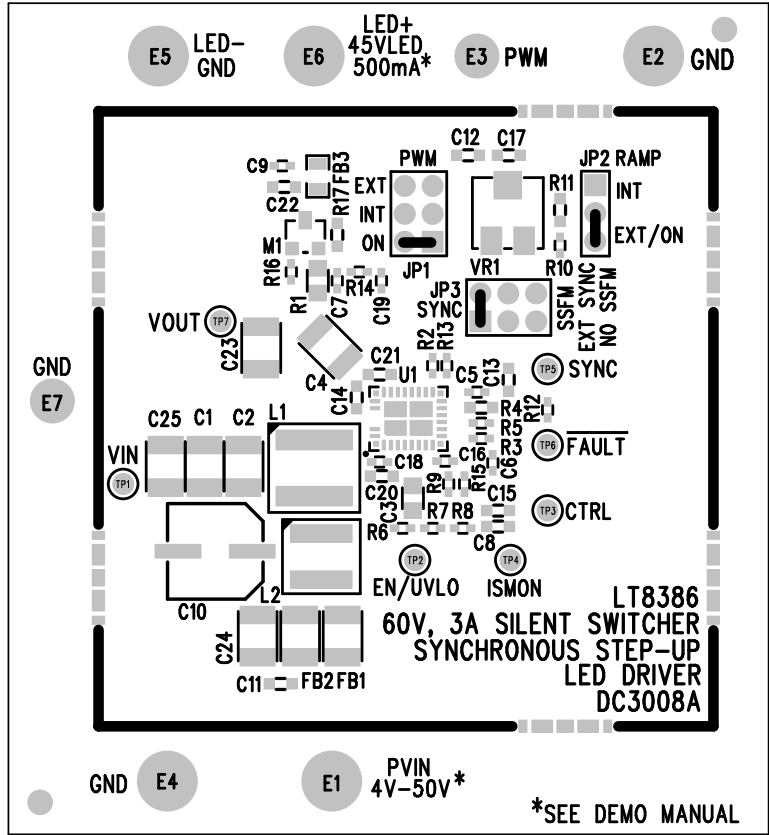

Figure 11. EMI shield clips can be soldered to the six placeholders on the PCB. A square 44mm x 44mm outline shows where the EMI shield fits onto the PCB.

## PARTS LIST

ITEM	QTY	REFERENCE	PART DESCRIPTION	MANUFACTURER/PART NUMBER
<b>Required Circuit Components</b>				
1	3	C1, C2, C25	CAP., 4.7uF, X7R, 50V, 10%, 1210, AEC-Q200	MURATA, GCM32ER71H475KA55L
2	1	C3	CAP., 1uF, X7R, 50V, 10%, 0805, AEC-Q200	MURATA, GCM21BR71H105KA03L
3	2	C4, C23	CAP., 4.7uF, X7S, 100V, 10%, 1210, AEC-Q200	MURATA, GCM32DC72A475KE02L
4	1	C5	CAP., 0.1uF, X7R, 16V, 10%, 0402	AVX, 0402YC104KAT2A
5	1	C6	CAP., 470pF, C0G, 50V, 5%, 0402, AEC-Q200	TDK, CGA2B2C0G1H471J050BA
6	2	C14, C21	CAP., 0.47uF, X7R, 50V, 10%, 0603, AEC-Q200	TDK, CGA3E3X7R1H474K080AB
7	1	C16	CAP., 0.1uF, X7R, 25V, 10%, 0402, AEC-Q200	MURATA, GCM155R71E104KE02D
8	1	C18	CAP., 0.033uF, X7R, 25V, 10%, 0402	KEMET, C0402C333K3RACTU
9	1	C20	CAP., 1uF, X7R, 10V, 10%, 0603	AVX, 0603ZC105KAT2A
10	1	R1	RES., 0.20 OHMS, 1%, 1/3W, 0805, AEC-Q200	PANASONIC, ERJ-6BSFR20V
11	1	R2	RES., 294k OHMS, 1%, 1/16W, 0402, AEC-Q200	VISHAY, CRCW0402294KFKED
12	1	R3	RES., 20k OHMS, 1%, 1/10W, 0402, AEC-Q200	PANASONIC, ERJ2RKF2002X
13	1	R4	RES., 1M OHM, 1%, 1/10W, 0603, AEC-Q200	PANASONIC, ERJ3EKF1004V
14	1	R5	RES., 22.1k OHMS, 1%, 1/16W, 0402	VISHAY, CRCW040222K1FKEDC
15	1	L1	IND., 22uH, PWR, 20%, 5A, 60.63mOHMS, 6.56mmX6.36mm, SHIELDED, AEC-Q200, XAL6060	COILCRAFT, XAL6060-223MEB
16	1	M1	XSTR., MOSFET, P-CHAN, 60V, 1.7A, SOT-23	VISHAY, SQ2309ES-T1_GE3
17	1	U1	IC, LED DRIVER CONTROLLER, LQFN-28	ANALOG DEVICES, LT8386JV#PBF
<b>Additional Demo Board Circuit Components</b>				
18	1	C7	CAP., 2.2uF, X5R, 6.3V, 10%, 0402	AVX, 04026D225KAT2A
19	1	C9	CAP., 0.01uF, X7S, 100V, 10%, 0402, AEC-Q200	TDK, CGA2B3X7S2A103K050BB
20	1	C10	CAP., 22uF, ALUM ELECT, 63V, 20%, SMD-CAN, AEC-Q200	PANASONIC, EEEFK1J220XP
21	1	C11	CAP., 0.1uF, X7R, 50V, 10%, 0603, AEC-Q200	TDK, CGA3E2X7R1H104K
22	1	C24	CAP., 2.2uF, X7R, 50V, 10%, 1210, AEC-Q200	TDK, CGA6M3X7R1H225K200AB
23	2	FB1, FB2	IND., 600 OHMS@100MHz, FERRITE BEAD, 30%, 3A, 42mOHMS, 1210, 1LN, AEC-Q200	TAIYO YUDEN, FBMH3225HM601NTV
24	1	FB3	IND., 220 OHMS @100MHz, FERRITE BEAD, 25%, 2A, 60mOHMS, 0805, AEC-Q200	TAIYO YUDEN, FBMH2012HM221-TV
25	1	L2	IND., 10uH, PWR, 20%, 4.9A, 45mOHMS, 5x5x5mm, AEC-Q200	COILCRAFT, XAL5050-103MEB
<b>Other Optional Electrical Components</b>				
26	0	C8, C12, C13, C17, C22	CAP., OPTION, 0603	
27	1	C15	CAP., 0.015uF, X7R, 50V, 5%, 0603, AEC-Q200	AVX, 06035C153J4T2A
28	0	C19	CAP., OPTION, 0402	
29	1	R6	RES., 499k OHMS, 1%, 1/16W, 0402, AEC-Q200	NIC, NRC04F4993TRF
30	1	R7	RES., 232k OHMS, 1%, 1/16W, 0402, AEC-Q200	VISHAY, CRCW0402232KFKED
31	1	R8	RES., 19.6k OHMS, 1%, 1/10W, 0402, AEC-Q200	PANASONIC, ERJ2RKF1962X
32	1	R9	RES., 100k OHMS, 1%, 1/16W, 0402, AEC-Q200	VISHAY, CRCW0402100KFKED
33	1	R10	RES., 118k OHMS, 1%, 1/16W, 0402, AEC-Q200	VISHAY, CRCW0402118KFKED
34	1	R11	RES., 91k OHMS, 5%, 1/10W, 0603, AEC-Q200	PANASONIC, 3GEYJ913V

# DEMO MANUAL DC3008A

---

## PARTS LIST

ITEM	QTY	REFERENCE	PART DESCRIPTION	MANUFACTURER/PART NUMBER
35	1	R12	RES., 51k OHMS, 5%, 1/16W, 0402, AEC-Q200	VISHAY, CRCW040251KOJNED
36	0	R13, R14, R15, R16	RES., OPTION, 0402	
37	0	R17	RES., OPTION, 0603	
38	1	VR1	RES., 100k OHMS, 20%, 1/4W, SMD 4mm SQ, 1-TURN, TOP ADJ., TRIMPOT	BOURNS, 3314J-1-104E

### Hardware: For Demo Board Only

39	2	JP1, JP3	CONN., HDR, MALE, 2x3, 2mm, VERT, ST, THT	WURTH, 62000621121
40	1	JP2	CONN., HDR, MALE, 1x3, 2mm, VERT, ST, THT	WURTH, 62000311121
41	3	XJP1, XJP2, XJP3	CONN., SHUNT, FEMALE, 2 POS, 2mm	WURTH, 60800213421
42	5	E1, E2, E4, E5, E6	TEST POINT, TURRET, 0.094" MTG. HOLE, PCB 0.062" THK	MILL-MAX, 2501-2-00-80-00-00-07-0
43	2	E3, E7	TEST POINT, TURRET, 0.064" MTG. HOLE, PCB 0.062" THK	MILL-MAX, 2308-2-00-80-00-00-07-0
44	0	CL1-CL6	Six EMI Shield clips	WURTH, 36900000
45	0	SH1	EMI Shield 44mm x 44mm	WURTH, 36907406S

**SCHEMATIC DIAGRAM**

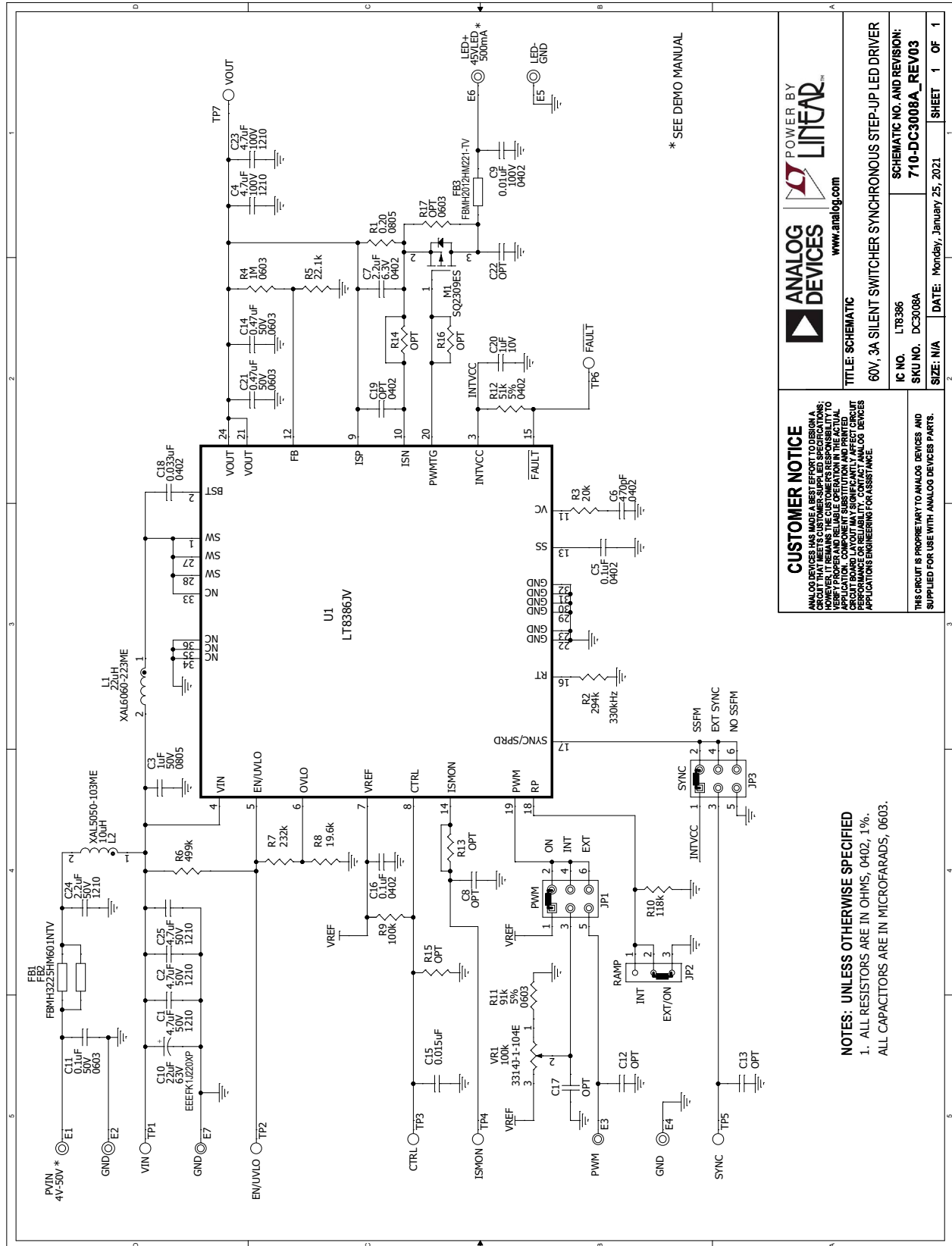

\* SEE DEMO MANUAL

	<a href="http://www.analog.com">www.analog.com</a>
<b>TITLE: SCHEMATIC</b>	
<b>60V, 3A SILENT SWITCHER SYNCHRONOUS STEP-UP LED DRIVER</b>	
<b>IC NO. LT8386</b>	<b>SCHEMATIC NO. AND REVISION:</b>
<b>SKU NO. DC3008A</b>	<b>710-DC3008A_REV03</b>
<b>SIZE: N/A</b>	<b>DATE: Monday, January 25, 2021</b>
<b>SHEET 1</b>	<b>OF 1</b>

**CUSTOMER NOTICE**  
 ANALOG DEVICES HAS MADE A BEST EFFORT FOR ACCURACY. HOWEVER, IT REMAINS THE CUSTOMER'S RESPONSIBILITY TO VERIFY PROPER AND RELIABLE OPERATION IN THE ACTUAL APPLICATION. ANALOG DEVICES MAY SIGNIFICANTLY AFFECT CIRCUIT PERFORMANCE OR RELIABILITY. CONTACT ANALOG DEVICES APPLICATION ENGINEERING FOR ASSISTANCE.

THIS CIRCUIT IS PROPRIETARY TO ANALOG DEVICES AND SUPPLIED FOR USE WITH ANALOG DEVICES PARTS.

**NOTES: UNLESS OTHERWISE SPECIFIED**  
 1. ALL RESISTORS ARE IN OHMS, 0402, 1%.  
 ALL CAPACITORS ARE IN MICROFARADS, 0603.



## ESD Caution

**ESD (electrostatic discharge) sensitive device.** Charged devices and circuit boards can discharge without detection. Although this product features patented or proprietary protection circuitry, damage may occur on devices subjected to high energy ESD. Therefore, proper ESD precautions should be taken to avoid performance degradation or loss of functionality.

## Legal Terms and Conditions

By using the evaluation board discussed herein (together with any tools, components documentation or support materials, the "Evaluation Board"), you are agreeing to be bound by the terms and conditions set forth below ("Agreement") unless you have purchased the Evaluation Board, in which case the Analog Devices Standard Terms and Conditions of Sale shall govern. Do not use the Evaluation Board until you have read and agreed to the Agreement. Your use of the Evaluation Board shall signify your acceptance of the Agreement. This Agreement is made by and between you ("Customer") and Analog Devices, Inc. ("ADI"), with its principal place of business at One Technology Way, Norwood, MA 02062, USA. Subject to the terms and conditions of the Agreement, ADI hereby grants to Customer a free, limited, personal, temporary, non-exclusive, non-sublicensable, non-transferable license to use the Evaluation Board FOR EVALUATION PURPOSES ONLY. Customer understands and agrees that the Evaluation Board is provided for the sole and exclusive purpose referenced above, and agrees not to use the Evaluation Board for any other purpose. Furthermore, the license granted is expressly made subject to the following additional limitations: Customer shall not (i) rent, lease, display, sell, transfer, assign, sublicense, or distribute the Evaluation Board; and (ii) permit any Third Party to access the Evaluation Board. As used herein, the term "Third Party" includes any entity other than ADI, Customer, their employees, affiliates and in-house consultants. The Evaluation Board is NOT sold to Customer; all rights not expressly granted herein, including ownership of the Evaluation Board, are reserved by ADI. CONFIDENTIALITY. This Agreement and the Evaluation Board shall all be considered the confidential and proprietary information of ADI. Customer may not disclose or transfer any portion of the Evaluation Board to any other party for any reason. Upon discontinuation of use of the Evaluation Board or termination of this Agreement, Customer agrees to promptly return the Evaluation Board to ADI. ADDITIONAL RESTRICTIONS. Customer may not disassemble, decompile or reverse engineer chips on the Evaluation Board. Customer shall inform ADI of any occurred damages or any modifications or alterations it makes to the Evaluation Board, including but not limited to soldering or any other activity that affects the material content of the Evaluation Board. Modifications to the Evaluation Board must comply with applicable law, including but not limited to the RoHS Directive. TERMINATION. ADI may terminate this Agreement at any time upon giving written notice to Customer. Customer agrees to return to ADI the Evaluation Board at that time. LIMITATION OF LIABILITY. THE EVALUATION BOARD PROVIDED HEREUNDER IS PROVIDED "AS IS" AND ADI MAKES NO WARRANTIES OR REPRESENTATIONS OF ANY KIND WITH RESPECT TO IT. ADI SPECIFICALLY DISCLAIMS ANY REPRESENTATIONS, ENDORSEMENTS, GUARANTEES, OR WARRANTIES, EXPRESS OR IMPLIED, RELATED TO THE EVALUATION BOARD INCLUDING, BUT NOT LIMITED TO, THE IMPLIED WARRANTY OF MERCHANTABILITY, TITLE, FITNESS FOR A PARTICULAR PURPOSE OR NON-INFRINGEMENT OF INTELLECTUAL PROPERTY RIGHTS. IN NO EVENT WILL ADI AND ITS LICENSORS BE LIABLE FOR ANY INCIDENTAL, SPECIAL, INDIRECT, OR CONSEQUENTIAL DAMAGES RESULTING FROM CUSTOMER'S POSSESSION OR USE OF THE EVALUATION BOARD, INCLUDING BUT NOT LIMITED TO LOST PROFITS, DELAY COSTS, LABOR COSTS OR LOSS OF GOODWILL. ADI'S TOTAL LIABILITY FROM ANY AND ALL CAUSES SHALL BE LIMITED TO THE AMOUNT OF ONE HUNDRED US DOLLARS (\$100.00). EXPORT. Customer agrees that it will not directly or indirectly export the Evaluation Board to another country, and that it will comply with all applicable United States federal laws and regulations relating to exports. GOVERNING LAW. This Agreement shall be governed by and construed in accordance with the substantive laws of the Commonwealth of Massachusetts (excluding conflict of law rules). Any legal action regarding this Agreement will be heard in the state or federal courts having jurisdiction in Suffolk County, Massachusetts, and Customer hereby submits to the personal jurisdiction and venue of such courts. The United Nations Convention on Contracts for the International Sale of Goods shall not apply to this Agreement and is expressly disclaimed.