



ProxSense® IQS360A Datasheet

12 Channel Projected Capacitive Touch & Proximity Controller with Trackpad and Keypad Capability

The **IQS360A** ProxSense® IC is 12-channel mutual capacitive touch and proximity controller with market leading sensitivity and automatic tuning. The **IQS360A** provides a cost effective implementation in a small outline package for **keypads** and **trackpads** of up to 4 rows and 3 columns. Keypads can offer second level touch activation (snap) when used with metal snap domes.

Main Features

- 12 mutual channel capacitive controller
- Trackpad with on chip XY coordinate calculation
- Configurable up to 4x3 elements
- 768 x 512 resolution
- Up to 50Hz report rate
- Absolute and relative tracking data
- 1MHz or 2MHz charge transfer frequency
- Advanced on-chip digital signal processing
- Automatic adjustment for optimal performance (ATI)
- User selectable proximity and touch thresholds
- Long proximity range
- Automatic drift compensation
- Fast I²C interface
- Event mode or streaming modes
- Low power, suitable for battery applications
- Supply voltage: 1.8V to 3.6V
- <3µA active sensing LP mode

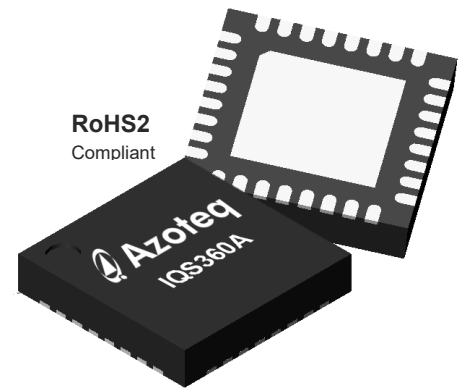

IQS360A QFN32

Representations only, not actual markings

Applications

- Trackpads
- Remote controls & smart remotes
- Electronic keypads or pin pads
- Printers and navigation key replacement

Available options

| | |
|----------------------|--------------------|
| T_A | QFN(5x5)-32 |
| -20°C to 85°C | IQS360A |



Contents

| | | |
|----|---|----|
| 1 | INTRODUCTION | 3 |
| 2 | ANALOGUE FUNCTIONALITY | 3 |
| 3 | DIGITAL FUNCTIONALITY | 4 |
| 4 | HARDWARE CONFIGURATION | 5 |
| 5 | USER CONFIGURABLE OPTIONS | 10 |
| 6 | PROXSENSE® MODULE | 20 |
| 7 | COMMUNICATION | 26 |
| 8 | RF NOISE | 29 |
| 9 | COMMUNICATION COMMAND/ADDRESS STRUCTURE | 30 |
| 10 | IQS360A OTP OPTIONS | 44 |
| 11 | SPECIFICATIONS | 45 |
| 12 | PACKAGE INFORMATION | 47 |
| 13 | DEVICE MARKING | 51 |
| 14 | ORDERING INFORMATION | 51 |
| 15 | DATASHEET REVISION HISTORY | 52 |
| 16 | ERRATA | 52 |
| | APPENDIX A. CONTACT INFORMATION | 53 |



1 Introduction

The **IQS360A** is a 12 channel (12 touch keys) mutual capacitive proximity and touch sensor capable of 4x3 trackpad calculations, featuring an internal voltage regulator and reference capacitor (C_s).

The **IQS360A** implements a trackpad using 4 receivers, and 3 transmitters. Three pins are used for serial data communication through the I²C™ compatible protocol, including an optional RDY pin.

The device automatically tracks slow varying environmental changes via various filters and is equipped with an Automatic Tuning Implementation (ATI) to adjust the device for optimal sensitivity.

The **IQS360A** is a variant of the IQS360 to meet different industry requirements. With these changes, time was taken to add improvements to the device. A key improvement is increased accuracy in the base-value selection of the ATI algorithm; this lends itself to improved linearity in trackpad applications.

1.1 Applicability

All specifications provided by this datasheet, except where otherwise stated, are applicable to the following ranges:

- Temperature -20°C to +85°C
- Supply voltage (V_{DDHI}) 1.8V to 3.6V

2 Analogue Functionality

CRX and CTX electrodes are arranged in a suitable configuration that results in a mutual capacitance (C_m) between the two electrodes. CTX is charged up to a set positive potential during a charge cycle which results in a negative charge build-up at CRX.

The resulting charge displacement is then measured within the **IQS360A** device through a charge transfer process that is periodically initiated by the digital circuitry. The capacitance measurement circuitry makes use of an internal reference capacitor C_s and voltage reference (V_{REF}).

The measuring process is referred to as a conversion and consists of the discharging of C_s and C_x capacitors, the charging of C_x and then a series of charge transfers from C_x to C_s until a trip voltage is reached. The number of charge transfers required to reach the trip voltage is referred to as the Counts (CS) value.

The analogue circuitry further provides functionality for:

- Power On Reset (POR) detection.
- Brown Out Detection (BOD).
- Internal regulation provides for accurate sampling.



3 Digital Functionality

The digital processing functionality is responsible for:

- Managing BOD and WDT events.
- Initiation of conversions at the selected rate.
- Processing of counts values and execution of algorithms.
- Monitoring and execution of the ATI algorithm.
- Signal processing and digital filtering.
- Detection of PROX, TOUCH and SNAP events.
- Managing outputs of the device.
- Managing serial communications.



4 Hardware Configuration

4.1 IQS360A Pin Out – QFN32

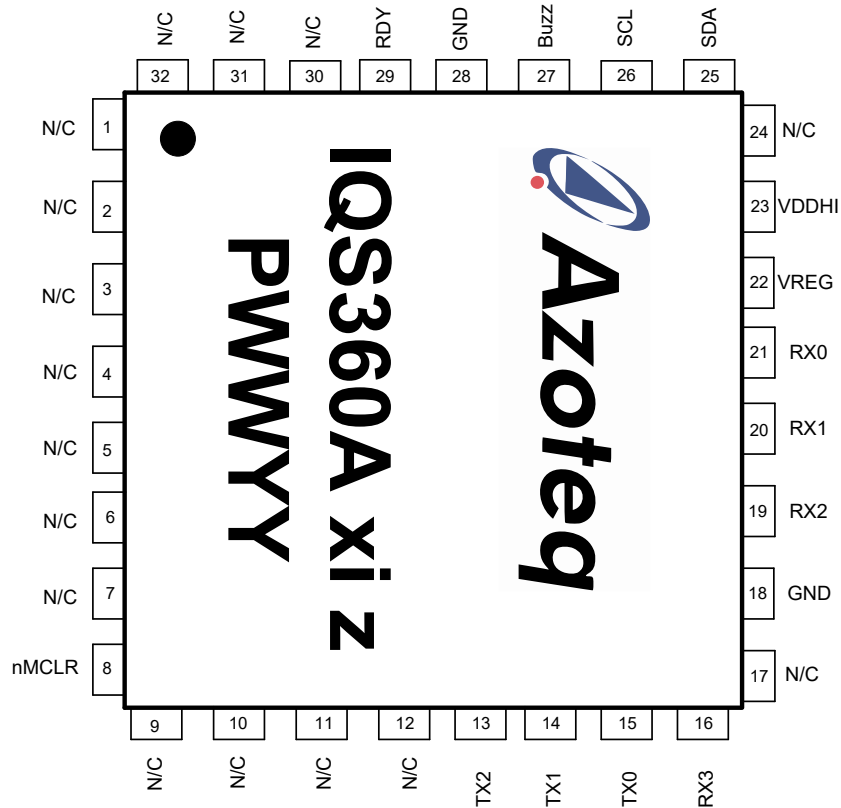

Figure 4.1 IQS360A Pin out in QFN-32.



Table 4.1 IQS360A QFN-32 Pin-outs.

| Pin | Pin Description | Function |
|-----|---------------------------|------------------------|
| 1 | N/C | No Connect |
| 2 | N/C | No Connect |
| 3 | N/C | No Connect |
| 4 | N/C | No Connect |
| 5 | N/C | No Connect |
| 6 | N/C | No Connect |
| 7 | N/C | No Connect |
| 8 | NMCLR | Master Clear |
| 9 | N/C | No Connect |
| 10 | Internal use ¹ | No Connect |
| 11 | Internal use | Connect to GND |
| 12 | Internal use | Connect to GND |
| 13 | TX2 | Sense Electrode |
| 14 | TX1 | Sense Electrode |
| 15 | TX0 | Sense Electrode |
| 16 | RX3 | Sense Electrode |
| 17 | N/C | No Connect |
| 18 | GND | Supply Ground |
| 19 | RX2 | Sense Electrode |
| 20 | RX1 | Sense Electrode |
| 21 | RX0 | Sense Electrode |
| 22 | VREG | Regulator Output |
| 23 | VDDHI | Supply Input |
| 24 | Internal use | No Connect |
| 25 | SDA | I ² C Data |
| 26 | SCL | I ² C Clock |
| 27 | BUZ | Buzzer |
| 28 | GND | Supply Ground |
| 29 | RDY | Ready |
| 30 | N/C | No Connect |
| 31 | N/C | No Connect |
| 32 | N/C | No Connect |

¹ Do not connect to GND



4.2 Reference Design

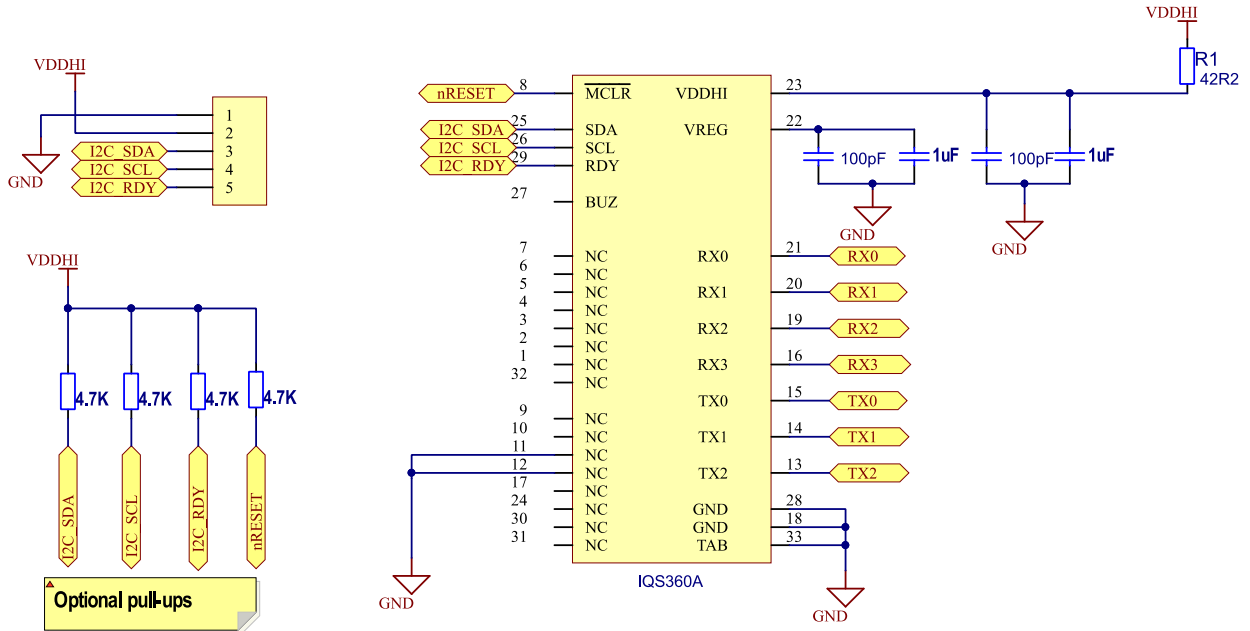

Figure 4.2 IQS360A Reference Design.

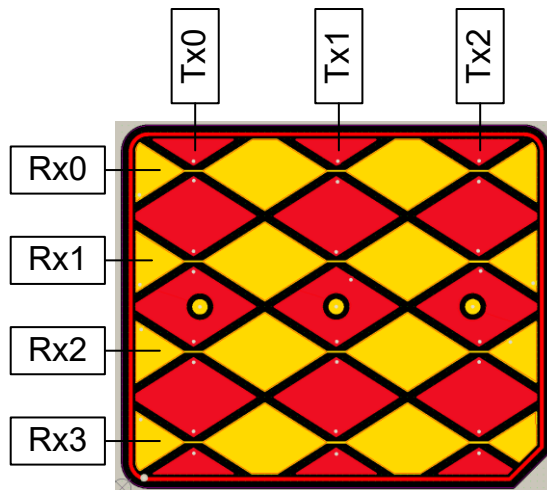



Figure 4.3 Trackpad Layout Reference.
Refer to the Trackpad Design Guide, application note AZD068.

Where a system level ESD strike is found to cause the IC to go into ESD induced latch-up, it is suggested that the supply current to the IQSXXX IC is limited by means of a series resistor that could limit the maximum supply current to the IC to <80mA.

4.3 Power Supply and PCB Layout

Azoteq IC's provide a high level of on-chip hardware and software noise filtering and ESD protection (refer to application note “AZD013 – ESD Overview”). Designing PCB's with better noise immunity against EMI, FTB and ESD in mind, it is always advisable to keep the critical noise suppression components like the decoupling capacitors and series resistors in **Figure 4.2** as close as possible to the IC. Always maintain a good ground connection and ground pour underneath the IC. For more guidelines please refer to the relevant application notes as mentioned in **Section 4.4**.

Where a system level ESD strike is found to cause the IC to go into ESD induced latch-up, it is suggested that the supply current to the IQS360A IC is limited by means of a series resistor that could limit the maximum supply current to the IC to <80mA.

4.4 Design Rules for Harsh EMC Environments

The figure below describes a typical flow diagram for designers to follow for applications affected by EMI. For more details, please refer to the appropriate application note.

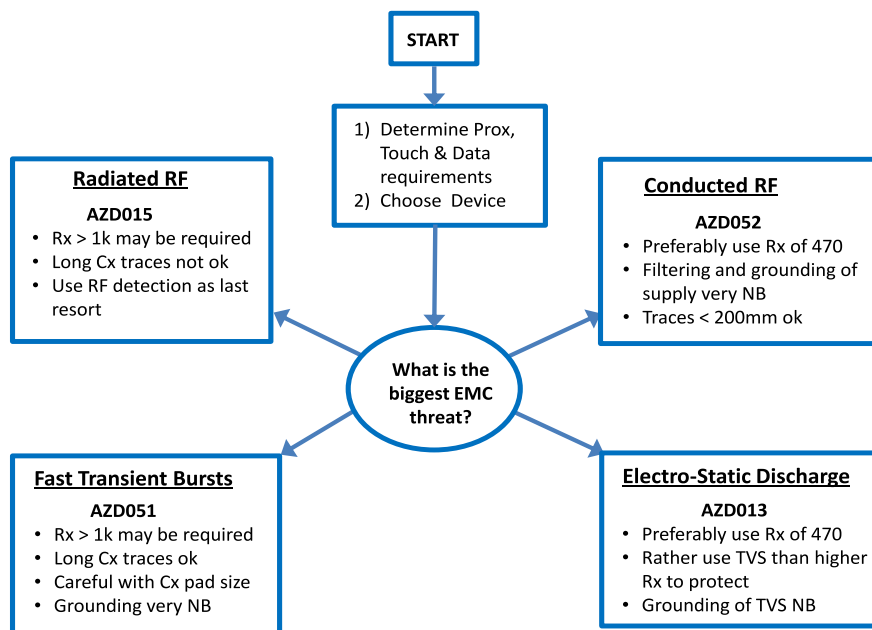

Figure 4.4 Typical flow diagram for EMC design.

➤ **Applicable application notes: AZD013, AZD015, AZD051, AZD052.**



4.5 High Sensitivity

Through patented design and advanced signal processing techniques, the device is highly sensitive, and can detect a user's presence at a distance. This enables designs to detect proximity at distances that cannot be equaled by most other products. When the device is used in environments where high levels of noise or floating metal objects exist, a reduced proximity threshold is proposed to ensure reliable functioning of the sensor. The high sensitivity also allows the device to sense through overlay materials with low dielectric constants, such as wood or porous plastics.

For more guidelines on the layout of capacitive sense electrodes, please refer to application note **AZD008**, available on the Azoteq web page: www.azoteq.com

5 User Configurable Options

The **IQS360A** requires configuration by a master/host controller or MCU. The developer needs to select the number of channels, trackpad size and corresponding touch and proximity thresholds.

5.1 Active Channels

The **IQS360A** can be configured to have up to 12 active touch channels (CH1-CH12) with one additional proximity channel (CH0). By default, CH0 is a distributed proximity channel, comprised of charging all the RX electrodes together as one self-capacitive channel. The sensor lines are connected together internally to achieve this.

The desired number of channels and the number of trackpad channels can be selected in [Register 0x0EH](#). The active channels will be from 0 up to n, where channel n is the last channel (maximum 12 channels).

Figure 5.1 illustrates the **IQS360A** channels mapped to the respective transmit (CTX) and receive (CRX) sense electrodes.

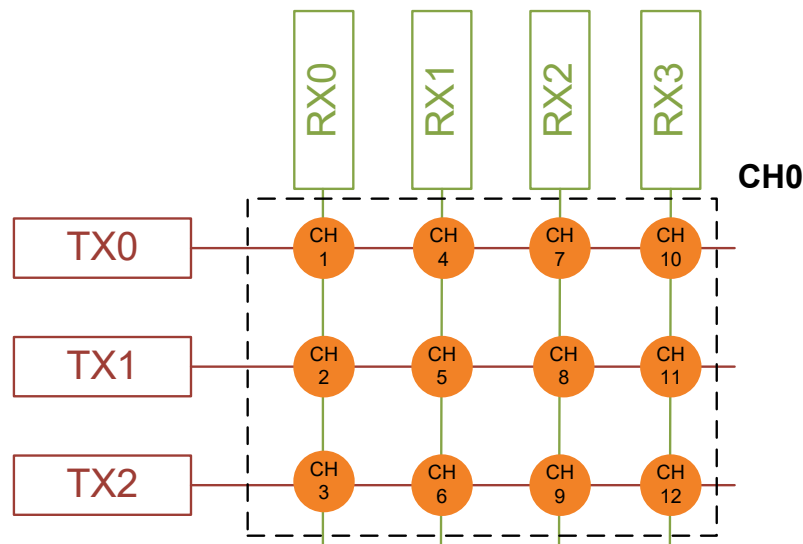

Figure 5.1 IQS360A Channel Mapping.

5.2 Operating Modes

Depending on the underlying design, the **IQS360A** can act as a proximity sensor, touch sensor – with or without snap capabilities – or, as a trackpad.

As indicated on the reference schematic in Figure 4.2 and Figure 4.3, the **IQS360A** is designed to function as a high speed trackpad when connected to a diamond grid pattern. Several selections are available to increase the speed of available data, including disabling the counts (noise) filters. The user has the option to read raw count values or XY-coordinates. XY data can be set to be absolute or relative values in [Register 0x08H](#) settings byte 3.



5.3 Proximity Threshold

A proximity threshold for channel 0 can be selected by the designer in [Register 0x09](#), byte 0, to obtain the desired proximity sensitivity. The proximity threshold is selectable between 1 (most sensitive) and 255 (least sensitive) counts. These threshold values (i.e. 1-255) are specified in Counts (CS).

Note: The **IQS360A** has a default proximity thresholds of $P_{TH} = 16$.

5.4 Touch Thresholds

A touch threshold for each channel can be selected by the designer to obtain the desired touch sensitivity and is selectable between 1/256 (most sensitive) to 255/256 (least sensitive). The touch threshold is calculated as a fraction of the Long-Term Average (LTA – average of counts over time) given by,

$$T_{THR} = x/256 \times LTA$$

With lower ATI target values (therefore lower LTA's) the touch threshold will be lower and vice versa.

Individual touch thresholds can be set for each channel (excl. CH0) in [Register 0x09](#), byte 1 to 12, for channels 1 to 12.

NOTE: The **IQS360A** has a default touch threshold of $16/256 \times LTA$ for all active channels.

5.5 Snap Thresholds

A snap threshold for each channel can be selected by the designer to obtain the desired snap sensitivity and is selectable between 1/256 (most sensitive) to 255/256 (least sensitive). The snap threshold is calculated as a fraction of the Long-Term Average (LTA) given by,

$$Snap_{THR} = x/256 \times LTA$$

With lower target values (therefore lower LTA's) the snap threshold will be lower and vice versa.

Individual snap thresholds can be set for each channel (excl. CH0) in [Register 0x0F](#), byte 0 to 11, for channels 1 to 12.

NOTE: The **IQS360A** has a default snap threshold of $24/256 \times LTA$ for all active channels.

WARNING: If a channel is disabled, it will require two communication windows to set the Snap Thresholds. The channel must be enabled in the first window, and the snap-threshold set in the subsequent window. This is only a limitation for the Snap Thresholds; all other settings can be set in the current communication window.

5.6 Power Modes

5.6.1 LP Modes

The **IQS360A** IC has a wide range of configurable low power modes, specifically designed to reduce current consumption for low power and battery applications.



The power modes are implemented around the occurrence of a charge cycle every t_{SAMPLE} seconds. The value of t_{SAMPLE} is determined by the custom (LP_{VALUE}) value between 1 and 255 in [Register 0x0A](#), byte 2, multiplied by 16ms. A value of '0' will indicate that there is no timing management, and the next cycle will start immediately after the current cycle has completed.

Lower sampling frequencies typically yield significant lower power consumption (but also decreases the response time).

NOTE: While in any power mode the device will zoom to Boost Power (BP) mode whenever the condition $(CS - LTA)^1 > \text{PROX_TH}$ or TOUCH_TH holds, indicating a possible proximity or touch event. This improves the response time. The device will remain in BP for t_{ZOOM} (4 seconds) after the last proximity event on CH0 is cleared and then return to the selected power mode. The zoom function allows reliable detection of events with count values being produced at the BP rate. The LP charge cycle timing is illustrated in **Figure 5.2**. Bit 3 in [Register 0x01](#), byte 0, will indicate if low power is active (bit 3), or the device is zoomed in (bit 0).

When designing for low power operation, the V_{REG} capacitors should ensure that V_{REG} does not drop more than 50mV during low power operations.

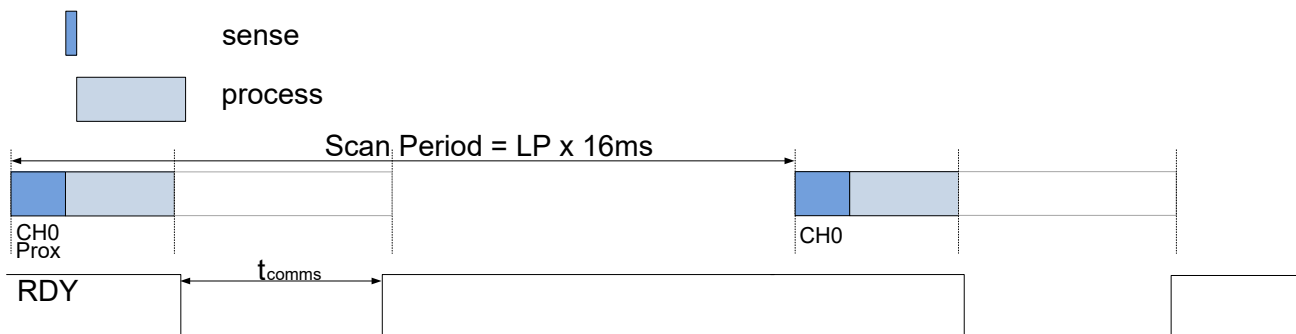

Figure 5.2 IQS360A Charge Cycle Timing in Low Power Mode.

Typical timings of the charge sequence shown above are listed in Table 5.1. These timings are only as reference, as they will differ with each application, depending on the setup of the IQS360A. For example, the sense (or charge time) is affected by the target counts and charge transfer frequency, while process time is dependent on the turbo mode activation, ATI checking for counts within the pre-set band, filter settings and XY-coordinate calculations. Communication time is affected by the MCU clock speed and the amount of data read (as well as the sequence thereof). Communication can be bypassed by using Event Mode, which means that communication is only initiated when certain events occur.

¹CS-LTA in Projected mode. LTA-CS in Self capacitive sensing mode.



Table 5.1 Typical Timings in LP mode

| Typical timings of IQS360A | | |
|----------------------------|--------------------------|----|
| t _{sense} | 900 | μs |
| t _{process} | 1.4 | ms |
| t _{comms} | 6 | ms |
| Scan Period | LP register setting x 16 | ms |

5.6.2 Sleep on Halt Timeout

Enabling Sleep on Halt Timeout means that instead of re-ATI on Halt-timer timeout, the chip will sleep for the time in LP above; see section **5.12.1 Halt Times** for more detail.

5.6.3 Hibernation Mode

For application where even lower power consumption is required, where the IQS360A can “hibernate” and no longer do conversions (no sensing). To enable Hibernate Mode, set both Force Sleep (bit 1) and Halt Charge (bit 4) active together in Settings byte 1, [Register 0x08](#).

During Hibernation Mode the sense engine is shut down and no conversion are performed. No RDY signal is generated, and the chip is essentially dormant. I²C communication is still active, and data can still be read or written from the chip. To wake out of Hibernation Mode, the Halt-Charge and Force-Sleep must be deactivated via I²C commands to the relevant registers.

5.7 Base Value

The **IQS360A** has the option to individually change the base value of each channel during the ATI algorithm. Depending on the application, this provides the user with another option to select the sensitivity of the **IQS360A** without changes in the hardware (CRX/CTX sizes and routing, etc.).

The base values are set in [Register 0x06](#), byte 0 to 12 (for channels 0 to 12). The base values can be selected to be **100 (default), 75, 150 or 200**.

The base value influences the overall sensitivity of the channel and establishes a base count from where the ATI algorithm starts executing. A lower base value will typically result in a higher sensitivity of the respective channel.

5.8 Target Value

The default target value of the **IQS360A** is 512 for the proximity channel and 256 for the touch channels.

The target value is calculated by multiplying the value in [Register 0x0B](#), byte 0 (for channel 0) & 1 (for channels 1 to 12) by 8.



Example: CH0 target = [Register Value](#)x8= 64(default) x 8 = 512.

5.9 Snap (Dome Click)

When adding a metal snap-dome or carbon contact dome as the overlay to the trackpad pattern, an additional “Snap” function is available. The device is able to distinguish between a normal “touch” on the overlay and an actual button “snap”, which depresses the metal dome onto the Rx/Tx pattern. This output is referred to as a snap. The design must be configured so that a snap on the metal dome will result in a channels’ sample value falling well below the Long-Term Average value for that channel. A few suggestions are:

- Place the snap-dome directly above a channel (thus exactly on the Rx-Tx junction)
- Alternatively place the snap-dome in the centre of the diamond pattern, and add a round pad of the second sensor inside the diamond.
- The snap-dome must consist of the standard metal dome or carbon circle pattern (or similar conductive material) on the inside of the dome.
- This conductive dome must be of adequate size to provide good count value deviation below the Long-Term Average of the channel on a snap.
- The conductive dome must however not be too big relative to the pitch of the Rx/Tx sensors, so as to not block the field lines for the trackpad sensing.
- No electrical connection between the snap-dome and the Rx-Tx must be made. Usually PCB solder-mask is adequate. Optimally the sensors are covered by solder-mask, with the snap-dome directly above.
- The snap-dome overlay must not have varying air-gaps between itself and the sensors. Thus having the overlay securely fastened to the PCB is ideal. A variable air-gap causes sporadic sensing, and gives unreliable data.

5.10 Settings Register 0

5.10.1 Proj Bias

The **IQS360A** has the option to change the bias current of the transmitter during projected sensing mode. A larger bias current is required to use larger electrodes, but will also increase the IC power consumption. The bias current is default on 10µA, and can be changed in [Register 0x08](#), Settings byte 0.

5.10.2 Stream ATI

In order to facilitate faster start-up and re-tuning times, the communication windows are stopped during ATI on the **IQS360A**. If the designer would like to be able to read data after every charge cycle during ATI, the communication can be enabled by setting the “Stream ATI” bit in [Register 0x08](#), Settings byte 0. A communication window can still be forced by the MCU with a RDY handshake (pulling the RDY line low) at any time even if the “Stream ATI” bit is not set.

5.10.3 Reseed

Setting the reseed bit in [Register 0x08](#), Settings byte 0, will reseed all LTA filters to a value of



$$LTA_{\text{new}} = CS + 8.$$

The LTA will then track the CS value until they are even.

Performing a reseed action on the LTA filters, will effectively clear any proximity and/or touch conditions that may have been established prior to the reseed call.

5.10.4 Re-ATI

An automatic re-ATI event will occur if the LTA is outside its re-ATI limits and no event is present on the applicable channel. The re-ATI limit or ATI boundary is calculated as the target value divided by 8. For example:

$$\text{Target} = 512, \text{ Re-ATI will occur if LTA is outside } 512 \pm 64.$$

A re-ATI event can also be issued by the host MCU by setting the REDO_ATI bit in [Register 0x08](#), Settings byte 0. The REDO_ATI bit will clear automatically after the ATI event was started.

NOTE: Re-ATI will automatically clear all proximity, touch, snap and halt status bits.

5.10.5 Snap Enable

The **IQS360A** has the option to enable snap detection on all active channels by setting the Snap_Enable bit in [Register 0x08](#), Settings byte 0. The user can read the snap status in [Register 0x03](#), bytes 2 and 3.

5.11 Settings Register 1

5.11.1 ATI Band

The user has the option to select the re-ATI band as 1/8 of the ATI target (default) or 1/4 of the ATI target counts by setting the ATI BAND bit in [Register 0x08](#), byte 1 (Prox_Settings1).

5.11.2 Force Sleep

The **IQS360A** can be set to go back to low power mode at any time, even if touches are still present, by setting the Force Sleep bit in [Register 0x08](#), Settings byte 1 (Prox_Settings1). This will reseed CH0, and the **IQS360A** will go into low power, and wake up with movement in the counts larger than the proximity threshold in any direction.

This mode allows the master to put the device into a low power state even if a user finger is still on the trackpad. If a stationary XY point is sensed by the master, such as a user resting his finger on the trackpad for a certain length of time, a command is then sent by the master to the device to enter hibernation.

If for any reason the master wants to cancel the Touch Hibernate mode, then it must perform a 'force comms' similar to the way it does it in EVENT_MODE, by performing a RDY handshake.

5.11.3 Prox Projected

The proximity channel on the **IQS360A** (CH0) can be changed to charge in projected capacitive mode. This is achieved by setting the Prox Proj bit in [Register 0x08](#), Settings byte 1 (Prox_Settings1). Projected proximity sensing can be used with a single Rx or all Rx



electrodes. Single Rx is recommended for 3x3 trackpads, with proximity ring around the trackpad. For improved distance, a GND ring can be placed between the Rx ring and trackpad diamonds on the PCB layout. Rx on Multiple is recommended for 3x4 trackpads. The Rx on Multiple will set the IC to charge channels 1 to 9 together as CH0.

5.11.4 Halt Charge

Setting the Halt Charge bit in [Register 0x08](#), Settings byte 1, will stop all conversions.

This function is typically useful for ultra-low power requirements, where the **IQS360A** can be controlled by a host MCU and does not require wake-up on proximity or touch events.

During Halt Charge, a 512ms wake up timer is used. The VREG capacitor needs to ensure VREG does not drop more than 100mV during Halt Charge. A capacitor of 4.7uA or bigger is suggested. For applications using Halt Charge, pin 11 and pin 12 needs to be connected to GND.

5.11.5 Turbo Mode

Setting the Turbo Mode bit in [Register 0x08](#), Settings byte 1 will enable the **IQS360A** device to perform conversions (charge transfers) as fast as processing and communication allows. Enabling Turbo Mode will maximize detection speeds, while increasing current consumption. Disabling Turbo Mode will yield in a fixed sampling period (t_{sample}) by adding dead times if required after each conversion, ensuring the count filtering are working optimally.

5.11.6 Charge Transfer Speed

The frequency at which charge cycles are performed can be adjusted by the Charge Xfer Speed bits in the [Register 0x08](#), Settings byte 1.

Adjusting the charge transfer speed will change the charge cycle duration (t_{SENSE}) as shown in **Figure 5.2**.

The charge transfer frequency is a fraction of the main oscillator ($F_{\text{OSC}} = 8\text{MHz}$ or 4MHz) and can be set at **2MHz** (default) or **1MHz** (1MHz or 500kHz with F_{OSC} set to 4MHz).

5.11.7 ACK Reset

The SHOW_RESET bit can be read in [Register 0x01](#), byte 0, to determine whether a reset has occurred on the device. This bit will be set '1' after a reset.

The SHOW_RESET bit will be cleared (set to '0') by writing a '1' into the ACK_RESET bit in [Register 0x08](#), Settings byte 1. A reset will typically take place of a timeout during communication occurs.

5.12 Settings Register 2

5.12.1 Halt Times

The Halt Timer is started when a proximity or touch event occurs and is restarted when that event is removed or reoccurs. When a proximity condition occurs, the LTA value for channel 0 will be "halted", thus its value will be kept fixed, until the proximity event is cleared, or the halt timer reaches the halt time. The halt timer will count to the selected halt time (t_{HALT}), which can be configured in [Register 0x0A](#), byte 0.



At timeout, the output will be cleared, and a reseed or re-ATI event will occur (depending on whether the counts are within the ATI band).

The designer needs to select a halt timer value (t_{HALT}) to best accommodate the required application. The value of t_{HALT} is selectable between 1 and 255 (in multiples of 250ms). The default value is 0x50H (80 decimal times 250ms = 20 seconds).

There is also the option to set t_{HALT} timer to never halt, or always halt in [Register 0x08](#), Settings byte 2.

5.12.2 Event Mode

The **IQS360A** device can operate in an event-driven I²C communication mode (also called “Event Mode”), with the RDY pin ONLY indicating a communication window after a prescribed event has occurred (except for the setup window after POR).

These events are explained further in Section 5.16.

The events that trigger a communication window (shown by a RDY signal) can be setup in the Event Mask [Register 0x0C](#).

Event Mode can be enabled by setting the Event Mode bit in [Register 0x08](#), Settings byte 2.

NOTE: The device is also capable of functioning **without** a RDY line on a polling basis.

5.12.3 Timeout Disable

If no communication is initiated from the master/host MCU within the first t_{COMMS} ($t_{\text{COMMS}} = 20\text{ms}$) of the RDY line indicating that data is available (i.e. RDY = low), the device will resume with the next charge transfer cycle and the data from the previous conversion cycle will be lost. The **IQS360A** does, however, have the ability to buffer relative XY-data for use in application where a read is possible less frequently on the master controller.

This time-out function can be disabled by setting the TIME_OUT_DISABLE bit in [Register 0x08](#), Settings byte 2.

5.12.4 Counts Filter

The Counts Filter can be implemented to provide better stability of Counts (CS) in electrically noisy environments.

The Counts Filter also enforces a longer minimum sample time for detecting proximity events on CH0, which will result in a slower response rate when the device enters low power modes. The Counts Filter is enabled by default, and can be disabled in [Register 0x08](#), Settings byte 2.

The Counts Filter is automatically switched off when touch events are made, to increase the report rate for faster tracking. In some applications the count values may appear noisier.

5.12.5 Force Halt

The Force Halt bit in [Register 0x08](#), Settings byte 2 can be set to halt all current LTA values and prevent them from being adjusted towards the CS values.



Setting this bit overrides all filter halt settings and prevents the device from performing re-ATI events in cases where the CS values persist outside the ATI boundaries for extended periods of time. Reseed will also not be possible.

5.12.6 WDT Disable

The WDT (watchdog timer) is used to reset the IC if a problem (for example a voltage spike) occurs during communication. The WDT will time-out (and thus reset the device) after t_{WDT} if no valid communication occurred during this time.

The WDT can be disabled by setting the WDT Off bit in [Register 0x08](#), Settings byte 2.

5.12.7 Sleep Halt

The **IQS360A** can go back into low power mode rather than reseed or re-tune (ATI) when a stuck condition or prolonged event is present. A low power time greater than zero need to be specified for this setting. To set up the sleep on halt time out feature, set the “Sleep Halt” bit in [Register 0x08](#), Settings byte 2. It is recommended to disable the Counts Filter ([Register 0x08](#)) when using this feature of the **IQS360A**. Keeping the Counts Filter enabled may cause a delay in entering low power as the counts may change causing a wake up event when the filter is re-enabled after the touch condition is cleared (upon halt time out). This is due to the automatic disabling of the Counts Filter when touch conditions are made to increase the trackpad report rate.

5.13 Settings Register 3

5.13.1 Coordinate Filter

The XY data coordinate filter can be switched off to increase the report rate, but will influence the accuracy of the tracking data. To switch off the coordinate filter, set the Coord Filter bit in [Register 0x08](#), Settings byte 3.

5.13.2 Relative Coordinates

By default the **IQS360A** will output trackpad data as absolute XY-coordinates. It is possible to change this output to relative coordinates by setting the Relative Coord bit in [Register 0x08](#), Settings byte 3.

The relative data is also buffered, allowing the host controller to skip communication windows, but still read the total amount of travel of the user finger on the trackpad.

5.13.3 RX on Multiple

The proximity channel (CH0) can be set charge in self capacitive- or projected capacitive mode. In projected mode the **IQS360A** can charge CTRX3 only as the receiver or CTRX0 to CTRX2 combined for CH0. To set the **IQS360A** to charge 3 Rx lines as the receiver the Rx Multiple bit in [Register 0x08](#), Settings byte 3 should be set.

5.13.4 LTA Beta

The beta value of all channels LTA filters can be adjusted by setting the Beta bits in [Register 0x08](#), Settings byte 3. Changing the Beta value will change the speed of the LTA following the counts.



5.14 Settings Register 4

5.14.1 Projected Up and Pass Time

The up and pass times for the charge transfer can be set in [Register 0x08](#), Settings byte 4. It is suggested to use the longest pass time (0x07) for most applications.

5.15 Settings Register 5

5.15.1 CTX / CRX Float

During the charge transfer process, the channels that are not being processed during the current cycle are effectively grounded to decrease the effects of noise-coupling between the sense electrodes.

In [Register 0x08](#), Settings byte 5, there is the option to specify which channels' transmit and/or receive electrodes to float when they are not charged.

5.16 Events Mask

In Event Mode certain events will initiate an I²C communication session (RDY goes LOW) to indicate an event has been triggered. These events include:

- ATI - A re-ATI procedure has occurred.
- ATI Error - there was an error during re-ATI.
- Proximity Detection - CH0 has crossed the proximity threshold.
- Touch Detection - One or more enabled channels have detected Touch.
- Snap Detection - One or more enabled channels have detected a Snap.
- Trackpad Movement - Relative movement has been detected on the trackpad.
- Wake-Up - The chip has woken from LP-mode sleep.

If simultaneous events have occurred in a cycle, e.g. prox & touch waking up the chip, then only a single communication session is initiated, and the events can be checked in byte 1 of System Flags register, [Register 0x01](#).

It may be useful to ignore certain events in a given application; this is done by clearing the corresponding bit in the Events Mask register, [Register 0x0C](#).

The Events Mask simply stops the device from initiating communication sessions for the defined events; while the corresponding event flag in byte 1 of System Flags will still be set to show that the event has occurred.



6 ProxSense® Module

The **IQS360A** contains a ProxSense® module that uses patented technology to provide detection of proximity and touch conditions on numerous sensing lines.

The ProxSense® module is a combination of hardware and software, based on the principles of charge transfer measurements.

6.1 Charge Transfer Concept

On ProxSense® devices like the **IQS360A**, capacitance measurements are taken with a charge transfer process that is periodically initiated.

For mutual capacitive sensing, the device measures the capacitance between 2 electrodes referred to as the transmitter (CTX) and receiver (CRX).

The measuring process (also referred to as conversions) is referred to as a charge transfer cycle and consists of the following:

- Discharging of an internal sampling capacitor (C_S) and the electrode capacitors (mutual: CTX & CRX) on a channel.
- charging of CTX's connected to the channel (using VREG)
- and then a series of charge transfers from the CRX's to the internal sampling capacitors (C_S), until the trip voltage is reached.

The number of charge transfers required to reach the trip voltage on a channel is referred to as the Current Sample (**CS**) or Count value.

The device continuously repeats charge transfers on the sense electrodes connected to the CRX pins. For each channel a Long Term Average (**LTA**) is calculated (12 bit unsigned integer values). The count (**CS**) values (12 bit unsigned integer values) are processed and compared to the LTA to detect Touch and Proximity events.

For more information regarding capacitive sensing, refer to the application note: "**AZD004 – Azoteq Capacitive Sensing**".

NOTE: *Attaching scope probes to the CTX/CRX pins will influence the capacitance of the sense electrodes and therefore the related CS values of those channels. This will have an instant effect on the CS measurements.*

6.2 Rate of Charge Cycles

The **IQS360A** samples all its active channels (up to 12 + channel 0 for proximity) in 13 timeslots. The charge sequence (as measured on the receive electrodes) is shown in Figure 6.1, where CH0 is the proximity channel and charges first, followed by all other active channels. There is only a communication window after all active channels have been charged, and processing is completed during the next charge transfer (therefore after CH0).

By default CH0 charges on CTRX3 only, but can be configured to be a distributed electrode in [Register 0x08](#), Settings byte 3.



Then charging of CH0 comprises the simultaneous charging of the 4 receive electrodes (CRX0, CRX1, CRX2 and CRX3) in Self-Capacitive mode, thus realising a distributed load. Refer to **Figure 5.1** for **IQS360A** channel numbering.

6.2.1 Boost Power Rate

With the **IQS360A** zoomed to Boost Power (BP) mode, the sense channels are charged at a fixed sampling period (t_{SAMPLE}) per channel. This is done to ensure regular samples for processing of results.

It is calculated as each channel having a time ($t_{\text{SAMPLE}} = \text{charge period } (t_{\text{CHARGE}}) + \text{computation time}$) of approximately $t_{\text{SAMPLE}} = 1.6\text{ms}$. Thus the time between consecutive samples on a specific channel (t_{CH}) will depend on the number of enabled channels, the charge transfer speed and the length of communication between the **IQS360A** and the host MCU.

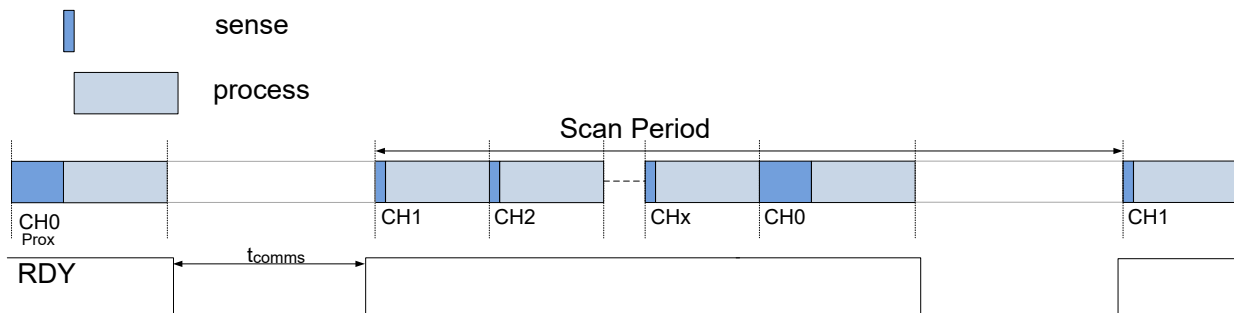

Figure 6.1 IQS360A charge cycle timing diagram in Boost Power mode.

Typical timings of the charge sequence shown above are listed in Table 6.1. These timings are only as reference, as they will differ with each application, depending on the setup of the **IQS360A**. For example, the sense (or charge time) is affected by the target counts and charge transfer frequency, while process time is dependent on the turbo mode activation, ATI checking for counts within the pre-set band, filter settings and XY-coordinate calculations. Communication time is affected by the MCU clock speed and the amount of data read (as well as the sequence thereof).



Table 6.1 Typical Timings

| Typical timings of IQS360A | | | |
|----------------------------|--------|-----------------|----|
| t _{sense} | | 200 | μs |
| t _{process} | | 1.4 | ms |
| t _{comms} | | 6 | ms |
| Scan Period ¹ | Turbo | 27.5 | ms |
| | Normal | 35 ² | ms |

6.2.2 Low Power Rate

A wide range of low current consumption charging modes is available on the **IQS360A**.

In any Low Power (LP) mode, there will be an applicable low power time (t_{LP}). This is determined by [Register 0x0A](#), byte 1. The value written into this register multiplied by 16ms will yield the LP time (t_{LP}).

With the detection of an undebounced proximity event the IC will zoom to BP mode, allowing a very fast reaction time for further possible touch events.

During any LP mode, only CH0 is charged every T_{LP}. The LP charge timing is illustrated in **Figure 5.2**.

If a low power rate is selected and charging is not in the zoomed state (BP mode), the low power active bit (Register 0x01) will be set.

Please refer to **Section 5.6**.

6.3 Touch Report Rate

During Boost Power (BP) mode, the touch report rate of the **IQS360A** device depends on the charge transfer frequency, the number of channels enabled and the length of communications performed by the host MCU or master device (influenced by the I²C clock frequency and the number of data bytes read).

Several factors may influence the touch report rate (and essentially the XY data report rate from the trackpad):

- **Enabled channels:** Disabling channels that are not used will not only increase the touch report rate, but will also reduce the device's current consumption.
- **Turbo Mode:** See Section 5.11.5

¹ All channels active, with all data being read during communication window. All settings default.

² Includes sleep time to force constant sample period.



- **Target Values:** Lower target values require shorter charge transfer periods (t_{CHARGE}), thus reducing the overall sampling period (t_{SAMPLE}) of each channel and increasing the touch report rate.
- **Charge Transfer Speed:** Increasing the charge transfer frequency will reduce the conversion period (t_{CHARGE}) and increase the touch report rate.
- **Internal Clock.** The **IQS360A** has the ability to reduce the internal oscillator frequency from 8MHz to 4MHz in [Register 0x01H](#), byte 1. This will reduce power consumption, but will also slow down the report rate.

6.4 Long Term Average

The Long-term Average (LTA) filter can be seen as the baseline or reference value. The LTA is calculated to continuously adapt to any environmental drift and is calculated from the CS value for each channel. The LTA filter allows the device to adapt to environmental (slow moving) changes/drift. Actuation (touch or prox) decisions are made by comparing the CS value with the LTA reference value.

The 12-bit LTA value for the indicated active channel (**ACT_CHAN** register [0x3D]) is contained in the **LTA_HI** and **LTA_LO** registers (0x83 and 0x84).

Please refer to **Section 5.12.1** for LTA Halt Times.

6.5 Determine Touch or Prox

An event is determined by comparing the CS value with the LTA. Since the CS reacts differently when comparing the self- with the mutual capacitance technology, the user should consider only the conditions for the technology used.

An event is recorded if:

- Self: $CS < LTA - \text{Threshold}$ (CH0 only)
- Mutual: $CS > LTA + \text{Threshold}$

Where Threshold can be either a Proximity or Touch threshold, depending on the channel being processed.

A proximity condition will be forced on a certain channel if a touch condition exists on that channel, even if the P_{TH} is greater than the T_{TH} . Similarly, if a snap condition exists, a proximity condition will be forced.

Please refer to **Section 5.3** and **5.4** for proximity and touch threshold selections.

6.6 ATI

The **Automatic Tuning Implementation (ATI)** is a sophisticated technology implemented on the new ProxSense® series devices. It allows for optimal performance of the devices for a wide range of sense electrode capacitances, without modification or addition of external components.

The ATI allows the tuning of two parameters, an ATI Multiplier and an ATI Compensation, to adjust the sample value for an attached sense electrode.



ATI allows the designer to optimize a specific design by adjusting the sensitivity and stability of each channel through the adjustment of the ATI parameters.

The **IQS360A** has a full ATI function. The full-ATI function is enabled by default, but can be disabled by setting the ATI_OFF and ATI_Partial bits in [Register 0x08](#), Settings byte 0.

The ATI_Busy bit in [Register 0x01H](#), byte 1 will be set while an ATI event is busy.

For more information regarding the ATI algorithm, please contact Azoteq at:

ProxSenseSupport@azoteq.com

6.6.1 ATI Method

The **IQS360A** can be set up to perform sensor calibration in two ways: Full ATI and Partial ATI. The ATI method is selected in [Register 0x08](#), Settings byte 0.

In Full ATI mode, the device automatically selects the multipliers through the ATI algorithm to setup the **IQS360A** as close as possible to its default sensitivity for the environment where it was placed.

The user can however, select Partial ATI, and set the multipliers to a pre-configured value. This will cause the **IQS360A** to only calculate the compensation (not the compensation and multipliers as in Full ATI), which allows the freedom to make the **IQS360A** more or less sensitive for its intended environment of use. The Partial ATI also reduces start-up and re-ATI times.

6.6.2 ATI Sensitivity

On the **IQS360A** device, the user can specify the BASE value (**Section 5.7**) for each channel individually and the TARGET values (**Section 5.8**) for the proximity (CH0) and touch (CH1-CH12) channels.

Sensitivity is a function of the base and target values as follows:

$$Sensitivity \propto \frac{TARGET}{BASE}$$

As can be seen from this equation, the sensitivity can be increased by either increasing the target value or decreasing the base value. It should however be noted that a higher sensitivity will yield a higher noise susceptibility.

6.6.3 ATI Target

The target value is reached by adjusting the COMPENSATION bits for each channel (ATI target limited to 2096 counts).

The target value is written into the respective channel's TARGET registers. The value written into these registers multiplied by 8 will yield the new target value. (Please refer to **Section 5.8**)

6.6.4 ATI Base (Multiplier)

The base value is calculated with the compensation set to zero. The following parameters will influence the base value:

- PROJ_BIAS bits: Adjusts the biasing of some analogue parameters in the mutual



capacitive operated IC. (Only applicable in mutual capacitance mode.)

- MULTIPLIER bits.

The base value used for the ATI function can be implemented in 2 ways:

1. `ATI_PARTIAL = 0`. ATI automatically adjusts MULTIPLIER bits to reach a selected base value¹. Please refer to **Section 5.7** for available base values.
2. `ATI_PARTIAL = 1`. The designer can specify the multiplier settings. These settings will give a custom base value from where the compensation bits will be automatically implemented to reach the required target value. The base value is determined by two sets of multiplier bits. Sensitivity Multipliers which will also scale the compensation to normalise the sensitivity and Compensation Multipliers to adjust the gain.

6.6.5 ATI ERROR

The ATI error bit (read only) in [Register 0x01](#), byte 1 (Sysflags) indicates to the user that the ATI targets where not reached. Adjustments of the base values or ATI BANDs are required.

¹ATI function will use user selected `CS_SIZE` and `PROJ_BIAS` (if applicable) and will only adjust the MULTIPLIER bits to reach the base values.



7 Communication

The **IQS360A** device interfaces to a master controller via a 3-wire (SDA, SCL and RDY) serial interface bus that is I²C™ compatible, with a maximum communication speed of 400kbit/s.

7.1 I²C Sub-address

The **IQS360A** has four available sub-addresses, 64H (default) to 67H, which allows up to four devices on a single I²C bus.

7.1.1 Internal sub-address selection

Selecting the sub-address via OTP bits allows the user 4 different options:

Table 7.1 I²C sub-address selection

| FG25 | FG26 | Device Address |
|------|------|----------------|
| 0 | 0 | 0x64 (default) |
| 0 | 1 | 0x65 |
| 1 | 0 | 0x66 |
| 1 | 1 | 0x67 |

7.2 Control Byte

The Control byte indicates the 7-bit device address (64H default) and the read/write indicator bit. The structure of the control byte is shown in Figure 7.1.

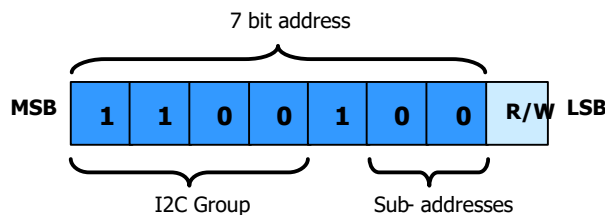

Figure 7.1 IQS360A Control Byte.

The I²C device has a 7-bit slave address (default 0x64H) in the control byte as shown in Figure 7.1. To confirm the address, the software compares the received address with the device address. Sub-address values can be set by OTP programming options.

7.3 I²C Read

To read from the device a *current address read* can be performed. This assumes that the address-command is already setup as desired. **NOTE:** only in the current communication window.

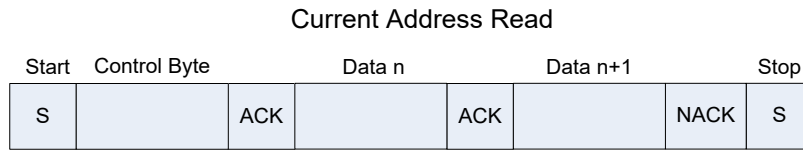

Figure 7.2 Current Address Read.

7.4 Random Read

If the address-command must first be specified, then a *random read* must be performed. In this case a WRITE is initially performed to setup the address-command, and then a repeated start is used to initiate the READ section.

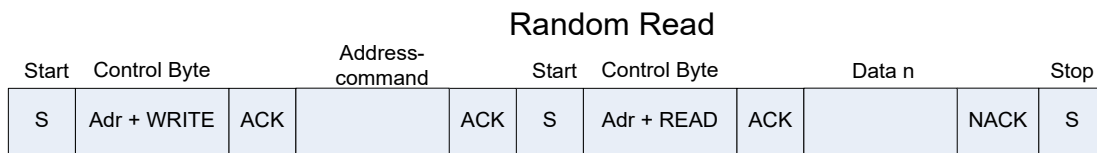

Figure 7.3 Random Read

7.5 I²C Write

To write settings to the device a *data write* is performed. Here the address-command is always required, followed by the relevant data bytes to write to the device.

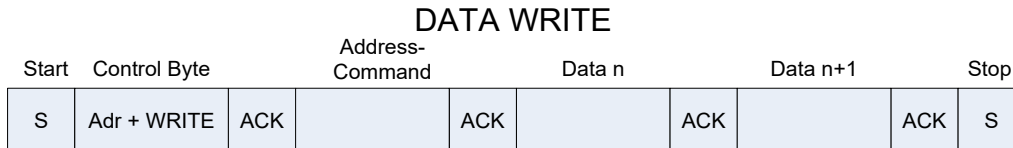

Figure 7.4 I²C Write.

7.6 End of Communication Session / Window

Similar to other Azoteq I²C devices, to end the I²C communication session, a STOP command is given. When sending numerous read and write commands in one communication cycle, a repeated start command must be used to stack them together (since a STOP will jump out of the communication window, which is not desired).

The STOP will then end the communication, and the **IQS360A** will return to process a new set of data. Once this is obtained, the communication window will again become available (RDY set LOW).

7.7 RDY Hand-Shake Routine

The **IQS360A** implements interrupt wakeup on the I²C bus, therefore the MCU could poll the **IQS360A** at any time where after the IC would acknowledge a valid I²C address, wake up and clock-stretch until the communication window is available.

The RDY line is still used to indicate events in Event Mode, and when conversions are complete in streaming mode.

The old IQS360 RDY-Hand-Shaking routine is now deprecated.



7.8 I²C Specific Commands

7.8.1 Show Reset

The SHOW_RESET bit can be read in [Register 0x01](#), byte 0, to determine whether a reset has occurred on the device. This bit will be set '1' after a reset.

The SHOW_RESET bit will be cleared (set to '0') by writing a '1' into the ACK_RESET bit in [Register 0x08](#), Settings byte 1. A reset will typically take place of a timeout during communication occurs.

7.9 I²C I/O Characteristics

The **IQS360A** requires the input voltages given in **Table 7.2**, for detecting high ("1") and low ("0") input conditions on the I²C communication lines (SDA, SCL and RDY).

Table 7.2 IQS360A I²C Input voltage

| | Input Voltage (V) |
|---------------------|-------------------|
| V _{inLOW} | 0.3*VDDHI |
| V _{inHIGH} | 0.7*VDDHI |

Table 7.3 provides the output voltage levels the host can expect during I²C communication. The communication lines are open drain, and require pull up resistors to provide the high level.

Table 7.3 IQS360A I²C Output voltage

| | Output Voltage (V) |
|----------------------|--------------------|
| V _{outLOW} | VSS +0.2 (max.) |
| V _{outHIGH} | VDDHI – 0.2 (min.) |



8 RF Noise

8.1 RF Noise Immunity

The **IQS360A** has advanced immunity to RF noise sources such as GSM cellular telephones, DECT, Bluetooth and WIFI devices. Design guidelines should however be followed to ensure the best noise immunity on a hardware level.

In general, the design of capacitive sensing applications may encompass a large range of configurations; however, following the guidelines in **Section 8.1.1** may improve a capacitive sensing design.

8.1.1 Notes for layout:

- A ground plane should be placed under the IC, except under the CRX lines.
- Place the sensor IC as close as possible to the sense electrodes.
- All the tracks on the PCB must be kept as short as possible.
- The capacitor between VDDHI and GND as well as between VREG and GND must be placed as close as possible to the IC.
- A 100 pF capacitor can be placed in parallel with the 1uF capacitor between VDDHI and GND. Another 100 pF capacitor can be placed in parallel with the 1uF capacitor between VREG and GND.
- When the device is too sensitive for a specific application a parasitic capacitor (max 5pF) can be added between the CX line and ground.
- Proper sense electrode and button design principles must be followed.
- Unintentional coupling of sense electrodes to ground and other circuitry must be limited by increasing the distance to these sources.
- In some instances a ground plane some distance from the device and sense electrode may provide significant shielding from undesirable interference.

However, if after proper layout, interference from an RF noise source persists, please refer to application note: “**AZD015: RF Immunity and detection in ProxSense devices**”.



9 Communication Command/Address Structure

9.1 Registers

Table 9.1 IQS360A Registers

| Address | Description | Access | Section |
|---------|---------------------------|--------|---------|
| 0x00H | Device Information | R | 9.2.1 |
| 0x01H | System Flags | R/W | 9.2.2 |
| 0x02H | XY-Data | R | 9.2.3 |
| 0x03H | Status | R | 9.2.4 |
| 0x04H | Counts | R | 9.2.5 |
| 0x05H | LTA | R | 9.2.6 |
| 0x06H | Multipliers | R/W | 9.2.7 |
| 0x07H | Compensation | R/W | 9.2.8 |
| 0x08H | Settings | R/W | 9.2.9 |
| 0x09H | Thresholds | R/W | 9.2.10 |
| 0x0AH | Timings | R/W | 9.2.11 |
| 0x0BH | ATI Targets | R/W | 9.2.12 |
| 0x0CH | Events Mask | R/W | 9.2.13 |
| 0x0DH | [Not Implemented] | | |
| 0x0EH | Active Channels | R/W | 9.2.14 |
| 0x0FH | Snap Thresholds | R/W | 9.2.15 |
| 0x10H | Trackpad Filters | R/W | 9.2.16 |
| 0x11H | Buzzer | R/W | 9.2.17 |



9.2 Register Descriptions

9.2.1 Device Information 0x00H

Information regarding the device type and version is recorded here. Any other information specific to the device version can be stored here. Each Azoteq ROM has a unique Product- and Version number.

| | | Product Number (PROD_NUM) | | | | | | | |
|--------|-------|---------------------------|---|---|---|---|---|---|---|
| Access | Bit | 7 | 6 | 5 | 4 | 3 | 2 | 1 | 0 |
| R | Value | 55 (Decimal) ¹ | | | | | | | |

| | | Version Number (VERSION_NUM) | | | | | | | |
|--------|-------|------------------------------|---|---|---|---|---|---|---|
| Access | Bit | 7 | 6 | 5 | 4 | 3 | 2 | 1 | 0 |
| R | Value | 02(Decimal) | | | | | | | |

9.2.2 System Flags 0x01H

| | | System Flags(SYSFLAGS) | | | | | | | |
|--------|------|------------------------|---------------|-------|--------|-----------|----------|---|------|
| Access | Bit | 7 | 6 | 5 | 4 | 3 | 2 | 1 | 0 |
| R | Name | Show reset | Filter Halted | 8M 4M | Is Ch0 | LP Active | ATI Busy | ~ | Zoom |

| | | Events | | | | | | | |
|--------|------|-----------|---|------------|---------|-------------|-------------|------------|-----------|
| Access | Bit | 7 | 6 | 5 | 4 | 3 | 2 | 1 | 0 |
| R | Name | ATI ERROR | ~ | Snap Event | Wake-UP | Track Event | Touch Event | Prox Event | ATI Event |

¹ Product and Version number will be 32 13 for QFN20 – for alpha customers only



9.2.3 XY-Data 0x02H

| | | X Low | | | | | | | |
|--------|------|-----------------------|---|---|---|---|---|---|---|
| Access | Bit | 7 | 6 | 5 | 4 | 3 | 2 | 1 | 0 |
| R | Name | X Coordinate Low Byte | | | | | | | |
| Byte 0 | | | | | | | | | |

| | | X High | | | | | | | |
|--------|------|------------------------|---|---|---|---|---|---|---|
| Access | Bit | 7 | 6 | 5 | 4 | 3 | 2 | 1 | 0 |
| R | Name | X Coordinate High Byte | | | | | | | |

| | | Y Low | | | | | | | |
|--------|------|-----------------------|---|---|---|---|---|---|---|
| Access | Bit | 7 | 6 | 5 | 4 | 3 | 2 | 1 | 0 |
| R | Name | Y Coordinate Low Byte | | | | | | | |

| | | Y High | | | | | | | |
|--------|------|------------------------|---|---|---|---|---|---|---|
| Access | Bit | 7 | 6 | 5 | 4 | 3 | 2 | 1 | 0 |
| R | Name | Y Coordinate High Byte | | | | | | | |
| Byte 3 | | | | | | | | | |

9.2.4 Status 0x03H

| | | Touch Channels 0 | | | | | | | |
|--------|------|------------------|-----|-----|-----|-----|-----|-----|--------------|
| Access | Bit | 7 | 6 | 5 | 4 | 3 | 2 | 1 | 0 |
| R | Name | CH7 | CH6 | CH5 | CH4 | CH3 | CH2 | CH1 | CH0/ Prox |
| Byte 0 | | | | | | | | | |



| | | Touch Channels 1 | | | | | | | |
|--------|------|------------------|---|---|------|------|------|-----|-----|
| Access | Bit | 7 | 6 | 5 | 4 | 3 | 2 | 1 | 0 |
| R | Name | | | | CH12 | CH11 | CH10 | CH9 | CH8 |

| | | Snap Channels 0 | | | | | | | |
|--------|------|-----------------|-----|-----|-----|-----|-----|-----|---|
| Access | Bit | 7 | 6 | 5 | 4 | 3 | 2 | 1 | 0 |
| R | Name | CH7 | CH6 | CH5 | CH4 | CH3 | CH2 | CH1 | |

| | | Snap Channels 1 | | | | | | | |
|--------|------|-----------------|---|---|------|------|------|-----|-----|
| Access | Bit | 7 | 6 | 5 | 4 | 3 | 2 | 1 | 0 |
| R | Name | | | | CH12 | CH11 | CH10 | CH9 | CH8 |
| Byte 3 | | | | | | | | | |

9.2.5 Counts 0x04H

| | | CH0Low | | | | | | | |
|--------|------|--------------------------------------|---|---|---|---|---|---|---|
| Access | Bit | 7 | 6 | 5 | 4 | 3 | 2 | 1 | 0 |
| R | Name | Channel 0 CS (Counts) Low byte first | | | | | | | |

...

| | | CH n High | | | | | | | |
|--------|------|---|---|---|---|---|---|---|---|
| Access | Bit | 7 | 6 | 5 | 4 | 3 | 2 | 1 | 0 |
| R | Name | Last active channel, Count value (High byte last) | | | | | | | |

9.2.6 LTA 0x05H

| | | CH0LTA Low | | | | | | | |
|--------|------|------------------------------|---|---|---|---|---|---|---|
| Access | Bit | 7 | 6 | 5 | 4 | 3 | 2 | 1 | 0 |
| R | Name | Channel 0 LTA Low byte first | | | | | | | |

...



| | | CH n LTA High | | | | | | | |
|--------|------|---|---|---|---|---|---|---|---|
| Access | Bit | 7 | 6 | 5 | 4 | 3 | 2 | 1 | 0 |
| R | Name | Last active channel, LTA value (High byte last) | | | | | | | |

9.2.7 Multipliers 0x06H

| | | CH0Multipliers | | | | | | | |
|--------|------|----------------|---|-------------|---|---|---|---|---|
| Access | Bit | 7 | 6 | 5 | 4 | 3 | 2 | 1 | 0 |
| R | Name | Base | | Multipliers | | | | | |

Bit 7:6: 00 = 100 (default)
 01 = 75
 10 = 150
 11 = 200

...

| | | CH n Multipliers | | | | | | | |
|--------|------|------------------|---|-------------|---|---|---|---|---|
| Access | Bit | 7 | 6 | 5 | 4 | 3 | 2 | 1 | 0 |
| R | Name | Base | | Multipliers | | | | | |

9.2.8 Compensation 0x07H

| | | CH0Compensation value | | | | | | | |
|--------|------|----------------------------------|---|---|---|---|---|---|---|
| Access | Bit | 7 | 6 | 5 | 4 | 3 | 2 | 1 | 0 |
| R/W | Name | Compensation value for Channel 0 | | | | | | | |
| Byte 0 | | | | | | | | | |

...

| | | CH n Compensation Value | | | | | | | |
|--------|------|--|---|---|---|---|---|---|---|
| Access | Bit | 7 | 6 | 5 | 4 | 3 | 2 | 1 | 0 |
| R/W | Name | Compensation value for last Active Channel | | | | | | | |
| Byte n | | | | | | | | | |



9.2.9 Settings 0x08H

| | | Settings 0 | | | | | | | |
|--------|---------|-------------------------|-----------------------------|-----------------------------|--------------------------|------------------------|----------------------------|---------------------------|---|
| Access | Bit | 7 | 6 | 5 | 4 | 3 | 2 | 1 | 0 |
| R/W | Name | ATI OFF | ATI Partial | Snap Enable | Redo ATI | Reseed | Stream ATI | Proj Bias | |
| Byte 0 | Default | 0x06H | | | | | | | |

- Bit 7:** **ATI Off:** This bit disables automatic ATI
 0 = Automatic retuning is On
 1 = Automatic retuning is OFF (counts can drift outside the ATI band)
- Bit 6:** **ATI Partial:** This bit select between full and partial ATI
 0 = Full ATI
 1 = Partial ATI (multipliers needs to be se manually for base value)
- Bit 5:** **Snap Enable:** This bit enables snap
 0 = Disabled
 1 = Snap detection enabled
- Bit 4:** **Redo ATI:** This bit forces ATI
 0 = No action
 1 = ATI retunes (bit clears automatically)
- Bit 3:** **Reseed:** This bit forces LTA reseed
 0 = No action
 1 = Reseeds LTA values (bit clears automatically)
- Bit 2:** **Stream ATI:** This bit enables communication during ATI
 0 = No data streaming during ATI (default)
 1 = Data is sent via I²C during ATI
- Bit 1:0:** **Proj Bias:** These bits adjust the projected bias current
 00 = 2.5µA
 01 = 5µA
 10 = 10µA (default)
 11 = 20µA



| | | Settings 1 | | | | | | | |
|--------|---------|---------------------------|----------------------|----------------------------|-----------------------------|---|---------------------------|-----------------------------|--------------------------|
| Access | Bit | 7 | 6 | 5 | 4 | 3 | 2 | 1 | 0 |
| R/W | Name | ACK Reset | XFER | Turbo Mode | Halt Charge | ~ | Prox Proj | Force Sleep | ATI Band |
| Byte 1 | Default | 0x00H | | | | | | | |

- Bit 7:** **ACK Reset:** This bit clears the reset flag
0 = No Action
1 = Clears the Reset Flag (bit will clear automatically)
- Bit 6:** **XFER:** This bit changes the charge transfer frequency
0 = 2MHz
1 = 1MHz
- Bit 5:** **Turbo Mode:** This bit increases report rate
0 = Disabled
1 = Turbo mode enabled
- Bit 4:** **Halt Charge:** This bit stops sensing
0 = No action
1 = Halts conversions
- Bit 3:** Internal Use
- Bit 2:** **Prox Proj:** This bit selects sensing for CH0
0 = Self proximity sensing
1 = Projected proximity sensing
- Bit 1:** **Force Sleep:** This bit forces the IC to low power mode
0 = No Action
1 = Force Low Power mode (bit will clear upon Low Power exit)
- Bit 0:** **ATI Band:** This bit changes the re-ATI range
0 = 1/8 x LTA
1 = 1/4 x LTA



| | | Settings 2 | | | | | | | |
|--------|---------|----------------------------|-------------------------|----------------------------|---------------------------------------|----------------------------------|----------------------------|----------------------|---|
| Access | Bit | 7 | 6 | 5 | 4 | 3 | 2 | 1 | 0 |
| R/W | Name | Sleep Halt | WDT Off | Force Halt | Counts Filter Disable | Time Out Disable | Event Mode | Halt | |
| Byte 2 | Default | 0x00H | | | | | | | |

Bit 7: **Sleep Halt:** This bit send the IC to low power on halt time out

0 = No action

1 = Immediately sleep when Halt-timer times out

Bit 6: **WDT Off:** This bit disables the watchdog timer

0 = WDT ON

1 = WDT OFF

Bit 5: **Force Halt:** This bit forces the LTA filter to stop calculating

0 = No action

1 = All LTA values halted at current level (no ATI possible)

Bit 4: **Count Filter Disable:** This bit can disable noise filtering on counts

0 =Counts are filtered

1 = Counts filtering disabled

Bit 3: **Time Out Disable:** This bit disables the I2C time out

0 = No action

1 = Communication timeout disabled

Bit 2: **Event Mode:** This bit switches streaming to Event Mode

0 = Full streaming

1 = Event Mode streaming

Bit 1-0: **Halt:** These bits select LTA filter halt times

00 = Filter halt period (set in 0x0A)

01 = Filter halt period (set in 0x0A)

10 = Never halt

11 = Always halt



| | | Settings 3 | | | | | | | |
|--------|---------|------------|---|----------------------|---|---|--------------------------------|--------------------------------|------------------------------|
| Access | Bit | 7 | 6 | 5 | 4 | 3 | 2 | 1 | 0 |
| R/W | Name | ~ | ~ | Beta | | ~ | RX on Multiple | Relative Coord | Coord Filter |
| Byte 3 | Default | 0x06H | | | | | | | |

Bit 7: Internal use

Bit 6: Internal use

Bit 5:4: **Beta:** These bits set the LTA following speed

00 = 2⁵

01 = 2⁶

10 = 2⁷

11 = 2⁸

Bit 3: Internal use

Bit 2: **RX on Multiple:** This bit selects RX electrode to use for CH0

0 = Proximity sensing with CTRX3

1 = Proximity sensing with all Rx or Cx electrodes

Bit 1: **Relative Coord:** This bit switched between relative and absolute trackpad

0 = Absolute coordinates

1 = Relative coordinates

Bit 0: **Coord Filter:** This bit disables the trackpad coordinate filter

0 = Filtered XY data

1 = Unfiltered XY data

| | | Settings4 | | | | | | | |
|--------|---------|-----------|----|---|---|-------|------|---|---|
| Access | Bit | 7 | 6 | 5 | 4 | 3 | 2 | 1 | 0 |
| R/W | Name | | UP | | | UP_EN | PASS | | |
| Byte 5 | Default | 0x07H | | | | | | | |



| | | Setting 5 | | | | | | | |
|---------------|----------------|---------------------------|----------|----------|----------|----------|----------|----------|----------|
| Access | Bit | 7 | 6 | 5 | 4 | 3 | 2 | 1 | 0 |
| R/W | Name | CTR_X_VSS | | | | | | | |
| Byte 6 | Default | 0x7FH | | | | | | | |

9.2.10 Thresholds 0x09H

| | | CH0Threshold | | | | | | | |
|---------------|----------------|---------------------|----------|----------|----------|----------|----------|----------|----------|
| Access | Bit | 7 | 6 | 5 | 4 | 3 | 2 | 1 | 0 |
| R/W | Name | Proximity Threshold | | | | | | | |
| Byte 0 | Default | 0x04H | | | | | | | |

| | | CH1 Threshold | | | | | | | |
|---------------|----------------|---------------------------|----------|----------|----------|----------|----------|----------|----------|
| Access | Bit | 7 | 6 | 5 | 4 | 3 | 2 | 1 | 0 |
| R/W | Name | Channel 1 Touch Threshold | | | | | | | |
| Byte 1 | Default | 0x10H | | | | | | | |

...

| | | CH12 Threshold | | | | | | | |
|----------------|----------------|----------------------------|----------|----------|----------|----------|----------|----------|----------|
| Access | Bit | 7 | 6 | 5 | 4 | 3 | 2 | 1 | 0 |
| R/W | Name | Channel 12 Touch Threshold | | | | | | | |
| Byte 12 | Default | 0x10H | | | | | | | |

9.2.11 Timings 0x0AH

| | | Filter Halt (t_HALT) | | | | | | | |
|---------------|----------------|----------------------|----------|----------|----------|----------|----------|----------|----------|
| Access | Bit | 7 | 6 | 5 | 4 | 3 | 2 | 1 | 0 |
| R/W | Name | Steps of 250ms | | | | | | | |
| Byte 0 | Default | 0x50H | | | | | | | |



| | | Power Mode (LP) | | | | | | | |
|--------|---------|-----------------|---|---|---|---|---|---|---|
| Access | Bit | 7 | 6 | 5 | 4 | 3 | 2 | 1 | 0 |
| R/W | Name | Steps of 16ms | | | | | | | |
| Byte 1 | Default | 0x00H | | | | | | | |

| | | Timeout Period | | | | | | | |
|--------|---------|-----------------|---|---|---|---|---|---|---|
| Access | Bit | 7 | 6 | 5 | 4 | 3 | 2 | 1 | 0 |
| R/W | Name | Steps of 1.28ms | | | | | | | |
| Byte 2 | Default | 0x10H | | | | | | | |

9.2.12 ATI Targets 0x0BH

| | | ATI Target CH0 | | | | | | | |
|--------|---------|-------------------------|---|---|---|---|---|---|---|
| Access | Bit | 7 | 6 | 5 | 4 | 3 | 2 | 1 | 0 |
| R/W | Name | Steps of 8 | | | | | | | |
| Byte 0 | Default | 0x40H | | | | | | | |
| ... | | | | | | | | | |
| | | ATI Targets CH1 to CH12 | | | | | | | |
| Access | Bit | 7 | 6 | 5 | 4 | 3 | 2 | 1 | 0 |
| R/W | Name | Steps of 8 | | | | | | | |
| Byte 1 | Default | 0x20H | | | | | | | |

9.2.13 Events Mask 0x0C

| | | Events Mask | | | | | | | |
|--------|---------|------------------|---|---------------|-------------|----------------|----------------|---------------|--------------|
| Access | Bit | 7 | 6 | 5 | 4 | 3 | 2 | 1 | 0 |
| R/W | Name | ATI ERRO R | ~ | Snap Event | Wake- Up | Track Event | Touch Event | Prox Event | ATI Event |
| | Default | 0xFF | | | | | | | |

Masks out the events triggered in the Events Register during Event Mode.



9.2.14 Active Channels 0x0EH

| | | Active Channels 0 | | | | | | | |
|--------|------|-------------------|-----|-----|-----|-----|-----|-----|-----|
| Access | Bit | 7 | 6 | 5 | 4 | 3 | 2 | 1 | 0 |
| R | Name | CH7 | CH6 | CH5 | CH4 | CH3 | CH2 | CH1 | CH0 |
| Byte 0 | | 0xFFH | | | | | | | |

| | | Active Channels 1 | | | | | | | |
|--------|------|-------------------|---|---|------|------|------|-----|-----|
| Access | Bit | 7 | 6 | 5 | 4 | 3 | 2 | 1 | 0 |
| R | Name | | | | CH12 | CH11 | CH10 | CH9 | CH8 |
| Byte 1 | | 0x03H | | | | | | | |

| | | Trackpad Active Channels 0 | | | | | | | |
|--------|------|----------------------------|-----|-----|-----|-----|-----|-----|-----|
| Access | Bit | 7 | 6 | 5 | 4 | 3 | 2 | 1 | 0 |
| R | Name | CH7 | CH6 | CH5 | CH4 | CH3 | CH2 | CH1 | CH0 |
| Byte 2 | | 0xFEH | | | | | | | |

| | | Trackpad Active Channels 1 | | | | | | | |
|--------|------|----------------------------|---|---|------|------|------|-----|-----|
| Access | Bit | 7 | 6 | 5 | 4 | 3 | 2 | 1 | 0 |
| R | Name | | | | CH12 | CH11 | CH10 | CH9 | CH8 |
| Byte 3 | | 0x1FH | | | | | | | |

9.2.15 Snap Thresholds 0x0FH

| | | CH1 Snap Threshold | | | | | | | |
|--------|---------|--------------------------|---|---|---|---|---|---|---|
| Access | Bit | 7 | 6 | 5 | 4 | 3 | 2 | 1 | 0 |
| R/W | Name | Channel 1 Snap Threshold | | | | | | | |
| Byte 0 | Default | 0x18H | | | | | | | |

...



| | | CH12 Snap Threshold | | | | | | | |
|---------|---------|---------------------------|---|---|---|---|---|---|---|
| Access | Bit | 7 | 6 | 5 | 4 | 3 | 2 | 1 | 0 |
| R/W | Name | Channel 12 Snap Threshold | | | | | | | |
| Byte 11 | Default | 0x18H | | | | | | | |

9.2.16 Trackpad Filters 0x10H

| | | Count Filter | | | | | | | |
|--------|---------|---------------------------|---|---|---|---|---|---|---|
| Access | Bit | 7 | 6 | 5 | 4 | 3 | 2 | 1 | 0 |
| R/W | Name | Counts Filtering Constant | | | | | | | |
| Byte 0 | Default | 0x01H | | | | | | | |

| | | XY BETA (Slow) | | | | | | | |
|--------|---------|--|---|---|---|---|---|---|---|
| Access | Bit | 7 | 6 | 5 | 4 | 3 | 2 | 1 | 0 |
| R/W | Name | Trackpad Coordinate Filter Constant for Slow Filtering | | | | | | | |
| Byte 1 | Default | 0x03H | | | | | | | |

| | | XY BETA (Fast) | | | | | | | |
|--------|---------|--|---|---|---|---|---|---|---|
| Access | Bit | 7 | 6 | 5 | 4 | 3 | 2 | 1 | 0 |
| R/W | Name | Trackpad Coordinate Filter Constant for Fast Filtering | | | | | | | |
| Byte 2 | Default | 0x00H | | | | | | | |

| | | DYNAMIC_XY_THRESHOLD | | | | | | | |
|--------|---------|----------------------|---|---|---|---|---|---|---|
| Access | Bit | 7 | 6 | 5 | 4 | 3 | 2 | 1 | 0 |
| R/W | Name | XY | | | | | | | |
| Byte 3 | Default | 0x0AH | | | | | | | |

Changes in the XY coordinates will be filtered with the slow Beta if it is smaller than the Dynamic_XY_Threshold. If changes in XY coordinates are larger than the Dynamic_XY_Threshold, the coordinates will be filtered with the fast Beta.



9.2.17 Buzzer Output 0x11H

| | | Buzzer 0 | | | | | | | |
|--------|---------|----------|---|---|---|---|----|------|-------|
| Access | Bit | 7 | 6 | 5 | 4 | 3 | 2 | 1 | 0 |
| R/W | Name | Enable | ~ | ~ | ~ | ~ | DC | PERM | Burst |
| Byte 0 | Default | 0x00H | | | | | | | |

This Byte sets up the Buzzer as shown below:

Bit 7: **Enable:** This bit enables or disables the buzzer output

0 = Disabled

1 = Enabled

Bit 6-3: **Not Used**

Bit 2: **DC:** Makes a DC output

0 = Low

1 = High

Bit 1: **Perm:** Permanently sounding the buzzer

0 = Disabled

1 = Enabled

Bit 0: **Burst:** Burst mode to make a “click” sound

0 = Disabled

1 = Enabled



10 IQS360A OTP Options

The **IQS360A** only provide **OTP (One-Time Programmable)** options for configuration of the device I²C sub-address.

Configuration of the OTP settings can be done on packaged devices or in-circuit. In-circuit configuration may be limited by values of external components chosen.

Azoteq offers a Configuration Tool (CT210 or later) and associated software that can be used to program the OTP user options for prototyping purposes. For further information regarding this subject, please contact your local distributor or submit enquiries to Azoteq at:

ProxSenseSupport@azoteq.com

10.1 User Selectable OTP options

Table 10.1 User Selectable OTP options : Bank3

| bit7 | Bank 3 | | | | | | bit0 |
|------------|------------|------------|------------|------------|---------------------------|---------------------------|------------|
| System use | System use | System use | System use | System use | I ² C SubAddr1 | I ² C SubAddr0 | System use |

| | |
|-----------------------|--|
| Bank3: bit7 | System Use |
| Bank3: bit6 | System Use |
| Bank3: bit5 | System Use |
| Bank3: bit4 | System Use |
| Bank3: bit 3 | System Use |
| Bank3: bit 2:1 | I²C SubAddr1: I²C SubAddr0 : I²C Sub-Address selection |
| | 00 = 0x64 (default) 01 = 0x65 10 = 0x66 11 = 0x67 |
| Bank3: bit 0 | System Use |



11 Specifications

11.1 Absolute Maximum Specifications

The following absolute maximum parameters are specified for the device:

Exceeding these maximum specifications may cause damage to the device.

- Operating temperature -20°C to 85°C
- Supply voltage (VDDHI – VSS) 3.6V
- Maximum pin voltage VDDHI + 0.5V
(may not exceed VDDHI max)
- Maximum continuous current (for specific Pins) 10mA
- Minimum pin voltage VSS - 0.5V
- Minimum power-on slope 100V/s
- ESD protection (Human body model) ±8kV
- Package Moisture Sensitivity Level (MSL) 3

11.2 General Operating Conditions

Table 11.1 IQS360A General Operating Conditions¹

| DESCRIPTION | Conditions | PARAMETER | MIN | TYP | MAX | UNIT |
|---------------------------|-------------------------------|----------------------|------|------|------|------|
| Supply voltage | | V _{DDHI} | 1.8 | 3.3V | 3.6 | V |
| Internal regulator output | 1.8 ≤ V _{DDHI} ≤ 3.6 | V _{REG} | 1.62 | 1.7 | 1.79 | V |
| Default operating current | 3.3V | I _{IQS360A} | - | 530 | | μA |
| Low Power setting 8* | 3.3V, LP=8 | 128ms | - | 14 | | μA |
| Low Power setting 16* | 3.3V, LP=16 | 256ms | - | 8 | | μA |
| Low Power setting 32* | 3.3V, LP=32 | 512ms | - | <6 | | μA |

*LP interval period = Low Power value x 16ms

¹Operating current shown in this datasheet, does not include power dissipation through I²C pull up resistors.



Table 11.2 Start-up and shut-down slope characteristics

| DESCRIPTION | CONDITIONS | PARAMETER | MIN | MAX | UNIT |
|------------------|--|-----------|-----|-----|------|
| Power On Reset | V_{DDHI} Slope $\geq 100V/s@25^{\circ}C$ | POR | - | 1.6 | V |
| Brown Out Detect | V_{DDHI} Slope $\geq 100V/s@25^{\circ}C$ | BOD | 1.0 | - | V |

11.3 Moisture Sensitivity Level

Moisture Sensitivity Level (MSL) relates to the packaging and handling precautions for some semiconductors. The MSL is an electronic standard for the time period in which a moisture sensitive device is allowed to be exposed to ambient room conditions (approximately 30°C/60%RH) before reflow (soldering or raising the temperature above 150°C) must occur.

Table 11.3 MSL

| Package | Level (duration) |
|-----------|-------------------|
| QFR5x5-32 | MSL 3 (168 hours) |

11.4 Recommended Storage Environment

This storage environment assumes that the IC's are packed properly inside a humidity barrier bag:

| Parameter | Description | Min | Typ | Max | Unit | Notes |
|------------------|----------------------|-----|-----|-----|------|--|
| T _{STG} | Storage Temperature | -55 | 25 | 150 | °C | Recommended storage temperature is 25 °C ± 25 °C. Extended duration storage at temperatures above 85 °C degrades reliability as well as reduces data retention performance |
| T _j | Junction Temperature | | | 150 | | |

11.4.1 Supplementary notes according to JEDEC recommendations:

- Optimal Storage Temperature Range: 5 °C to 30 °C
- Humidity: between 40 to 70% RH
- Air should be clean.
- Avoid harmful gasses and dust.
- Avoid outdoor exposure or storage in areas subject to rain or water spraying.
- Avoid condensation.
- Avoid storage in areas subject to corrosive gas or dust.
- Products shall not be stored in areas exposed to direct sunlight.
- Avoid rapid changes of temperature.
- Avoid mechanical stress such as vibration and impact.
- The products shall not be placed directly on the floor
- The products shall be stored on a level area, should not be turned upside down, nor placed against the wall.

12 Package information

12.1 IQS360A Package Dimensions

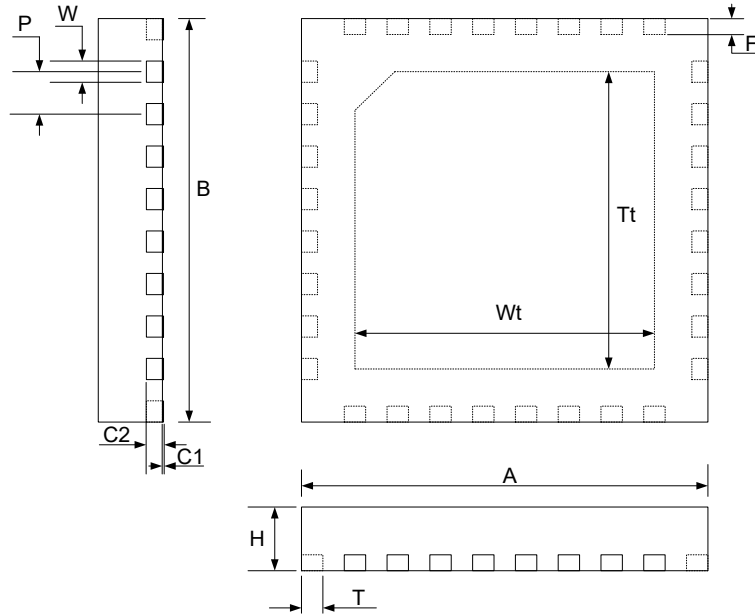

Figure 12.1 IQS360A Package. Drawings not to scale - illustration only.

Table 12.1 Packaging Dimensions.

| DESCRIPTION | QFR | | Unit |
|----------------|----------|------|------|
| | MIN | MAX | |
| A | 4.90 | 5.10 | mm |
| B | 4.90 | 5.10 | mm |
| C1 | 0 | 0.05 | mm |
| C2 | 0.203TYP | | mm |
| F | 0.3 | 0.4 | mm |
| H | 0.85 | 0.95 | mm |
| P | 0.5TYP | | mm |
| T | 0.3 | 0.5 | mm |
| T _t | 3.55 | 3.75 | mm |
| W | 0.25TYP | | mm |
| W _t | 3.55 | 3.75 | mm |

12.2 IQS360A Footprints

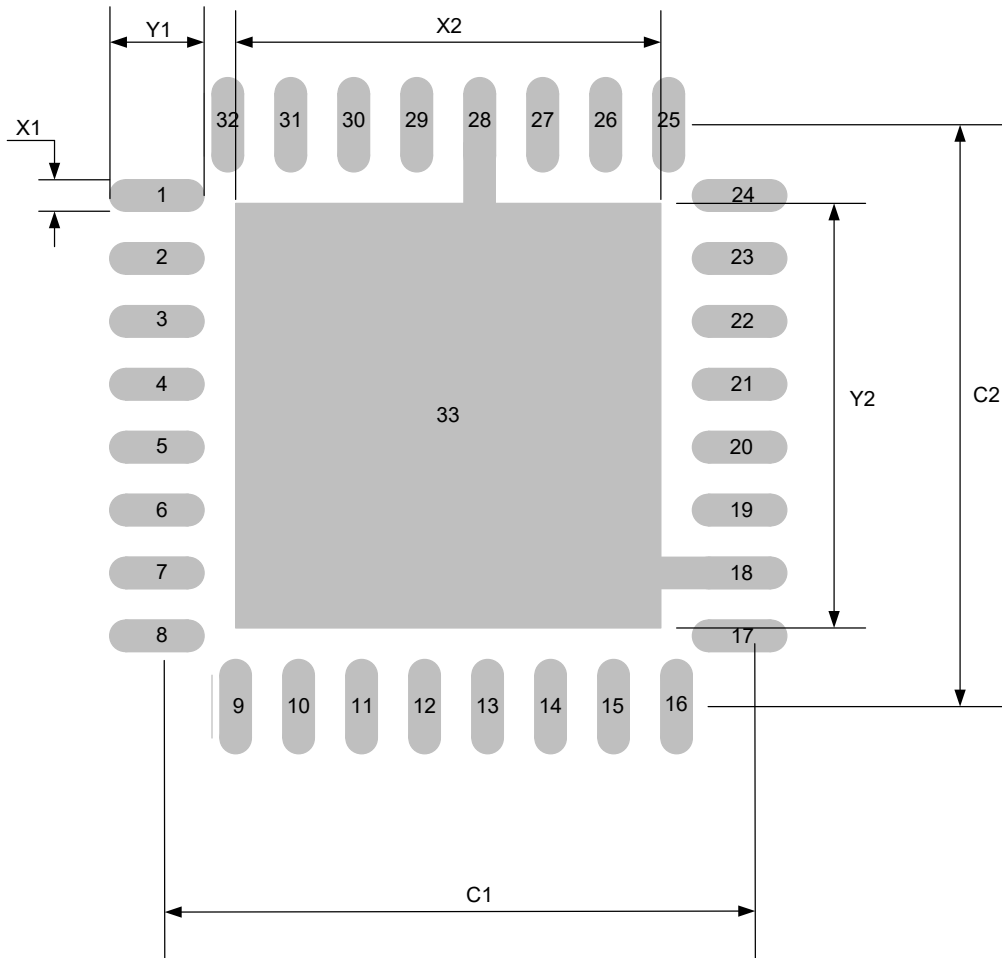

Figure 12.2 IQS360A Recommended Footprint. Illustration is not to scale.

Table 12.2 IQS360A Footprint Recommended Dimensions.

| Description | Dimension | Unit |
|-------------|-----------|------|
| C1 | 4.85 | mm |
| C2 | 4.85 | mm |
| X1 | 0.25 | mm |
| X2 | 3.65 | mm |
| Y1 | 0.8 | mm |
| Y2 | 3.65 | mm |

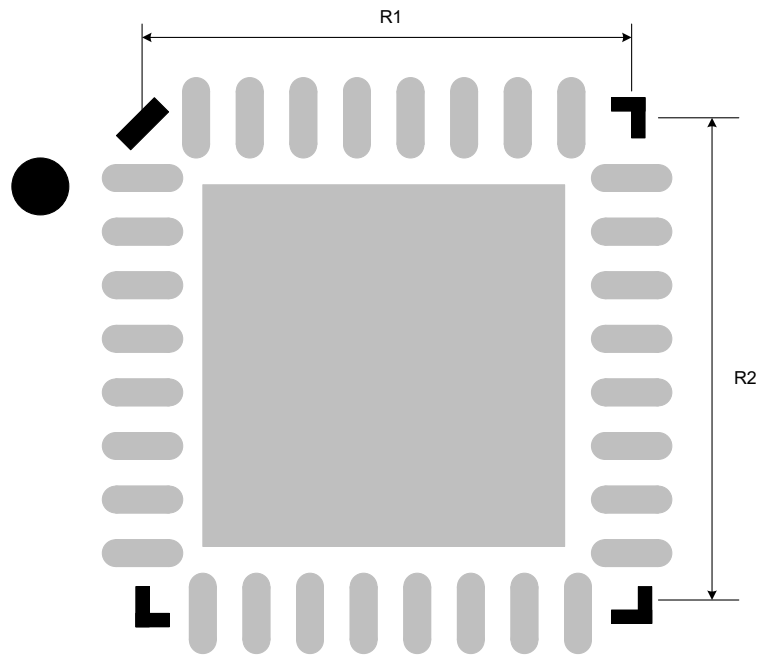

Figure 12.3 Silk Screen - optional.

Table 12.3 Silk Screen Dimensions.

| DESCRIPTION | Dimension | Unit |
|-------------|-----------|------|
| R1 | 5.00 | mm |
| R2 | 5.00 | mm |



12.3 Tape and Reel Information

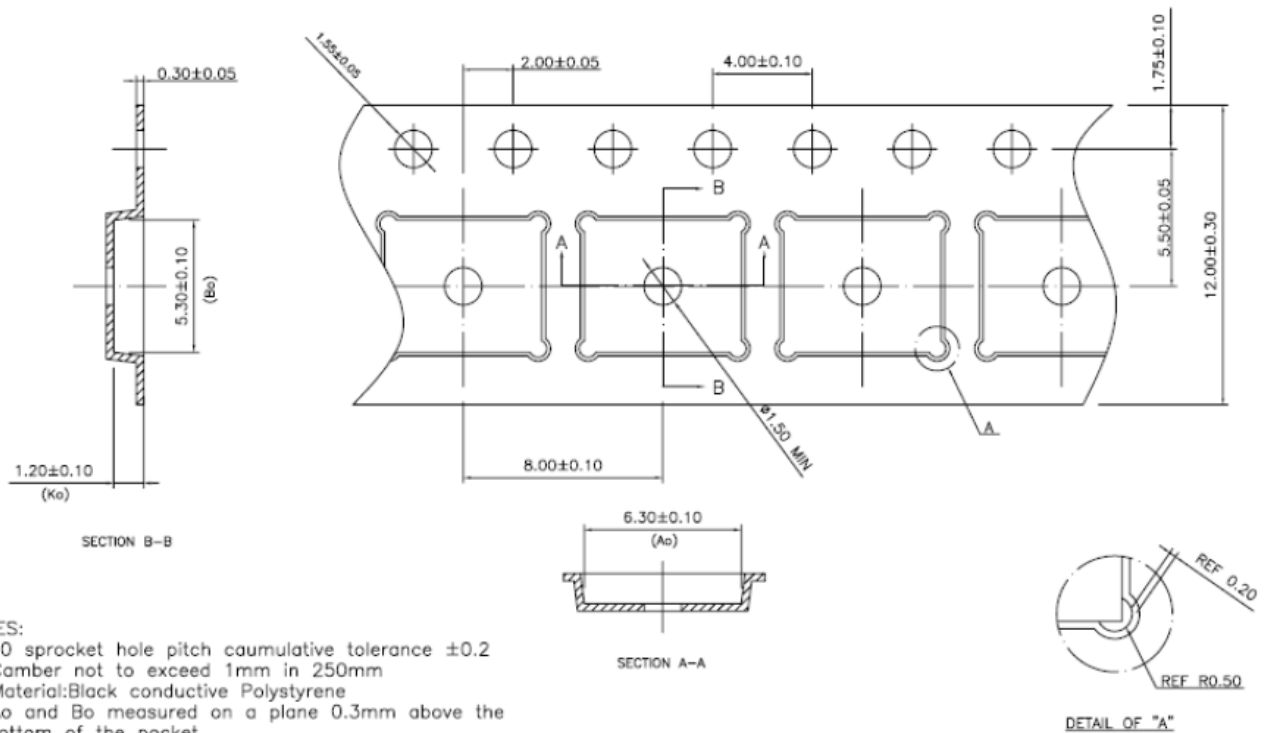
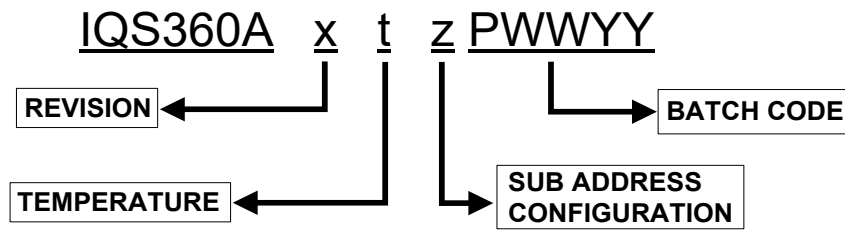

Figure 12.4 12mm Carrier Tape. Pin 1 – Left Bottom.



13 Device Marking



| | | | |
|------------------------------|-----------|---|---|
| REVISION | x | = | IC Revision Number |
| TEMPERATURE RANGE | t | = | I -20°C to 85°C (Industrial) C 0°C to 70°C (Commercial) |
| IC CONFIGURATION | z | = | Sub-Address Configuration (Hexadecimal) 0 = 64H 1 = 65H 2 = 66H 3 = 67H |
| BATCHCODE¹ | P | = | Package House |
| | WW | = | Week |
| | YY | = | Year |

1. The batch code represents the data of packaging, and may be different from the date code printed on the reel label.

14 Ordering Information

Order quantities will be subject to multiples of a full reel. Contact the official distributor for sample quantities. A list of the distributors can be found under the “Distributors” section of www.azoteq.com.

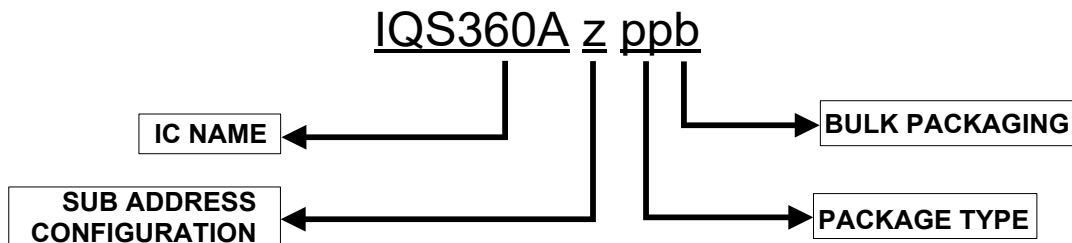

| | | | |
|-----------------------|----------------|---|---------------------|
| IC NAME | IQS360A | = | IQS360A |
| | 0 | = | 64H |
| | 1 | = | 65H |
| | 2 | = | 66H |
| | 3 | = | 67H |
| PACKAGE TYPE | QF | = | QFR (5x5)-32 |
| BULK PACKAGING | R | = | Reel (3000pcs/reel) |



15 Datasheet Revision History

Table 15.1 Document Revisions

| Revision | Description | Date |
|----------|--|----------------|
| 1.00 | Preliminary Release to Alpha Customers | January 2016 |
| 1.01 | Preliminary Release | March 2016 |
| 1.02 | First Release | June 2016 |
| 1.03 | Updated Contact Page | September 2016 |
| 1.04 | Updated Reference Schematic | September 2016 |
| 1.05 | Add Errata | July 2017 |
| 1.06 | Update Temperature Rating | September 2017 |
| 1.07 | Update Contact and Patent information | March 2018 |
| 1.08 | Update reference schematic for halt charge | May 2018 |

16 Errata

16.1 Base Value Selection for Low Power Mode

For base value selection lower than 200, while also using Low Power, the application software is required to monitor the base value (or “multipliers”) registers when there is an ATI event triggered while the IQS360A was sampling in LP mode.

Such auto ATI in LP can in some cases overwrite the base value options, resulting in erratic touch sensitivity (incorrect base values). In such cases it is recommended to re-initialize the IQS360A setup, and redo ATI.



| | USA | Asia | South Africa |
|-------------------------|--|---|--|
| Physical Address | 11940 Jollyville Suite 120-S Austin TX 78750 USA | Room 501A, Block A, T-Share International Centre, Taoyuan Road, Nanshan District, Shenzhen, Guangdong, PRC | 1 Bergsig Avenue Paarl 7646 South Africa |
| Postal Address | 11940 Jollyville Suite 120-S Austin TX 78750 USA | Room 501A, Block A, T-Share International Centre, Taoyuan Road, Nanshan District, Shenzhen, Guangdong, PRC | PO Box 3534 Paarl 7620 South Africa |
| Tel | +1 512 538 1995 | +86 755 8303 5294 ext 808 | +27 21 863 0033 |
| Email | info@azoteq.com | info@azoteq.com | info@azoteq.com |

Visit www.azoteq.com
for a list of distributors and worldwide representation.

Patents as listed on www.azoteq.com/patents-trademarks/ may relate to the device or usage of the device.

Azoteq®, Crystal Driver , IQ Switch®, ProxSense®, ProxFusion®, LightSense™, SwipeSwitch™, and the  logo are trademarks of Azoteq.

The information in this Datasheet is believed to be accurate at the time of publication. Azoteq uses reasonable effort to maintain the information up-to-date and accurate, but does not warrant the accuracy, completeness or reliability of the information contained herein. All content and information are provided on an "as is" basis only, without any representations or warranties, express or implied, of any kind, including representations about the suitability of these products or information for any purpose. Azoteq disclaims all warranties and conditions with regard to these products and information, including but not limited to all implied warranties and conditions of merchantability, fitness for a particular purpose, title and non-infringement of any third party intellectual property rights. Azoteq assumes no liability for any damages or injury arising from any use of the information or the product or caused by, without limitation, failure of performance, error, omission, interruption, defect, delay in operation or transmission, even if Azoteq has been advised of the possibility of such damages. The applications mentioned herein are used solely for the purpose of illustration and Azoteq makes no warranty or representation that such applications will be suitable without further modification, nor recommends the use of its products for application that may present a risk to human life due to malfunction or otherwise. Azoteq products are not authorized for use as critical components in life support devices or systems. No licenses to patents are granted, implicitly, express or implied, by estoppel or otherwise, under any intellectual property rights. In the event that any of the abovementioned limitations or exclusions does not apply, it is agreed that Azoteq's total liability for all losses, damages and causes of action (in contract, tort (including without limitation, negligence) or otherwise) will not exceed the amount already paid by the customer for the products. Azoteq reserves the right to alter its products, to make corrections, deletions, modifications, enhancements, improvements and other changes to the content and information, its products, programs and services at any time or to move or discontinue any contents, products, programs or services without prior notification. For the most up-to-date information and binding Terms and Conditions please refer to www.azoteq.com.