

# 600MHz to 7GHz Precision RF Detector with Fast Comparator Output

## FEATURES

- Temperature Compensated Internal Schottky Diode RF Detector
- Wide Input Frequency Range: 600MHz to 7GHz\*
- Wide Input Power Range: -26dBm to 12dBm
- Fast Comparator Output with Latch Enable
- 25ns Response Time with 0dBm RF Input Level
- Rail-to-Rail Output Swing
- Comparator Output Current: ±20mA
- Wide V<sub>CC</sub> Range of 2.7V to 5.5V
- Low Operating Current: 2mA
- Available in a Low Profile (1mm) SOT-23 Package

## APPLICATIONS

- RF Signal Presence Detectors for:
  - 802.11a, 802.11b, 802.11g, 802.15
  - Optical Data Links
  - Wireless Data Modems
  - Wireless and Cable Infrastructure
- RF Power Alarm
- Envelope Detector
- RF ID Tag Reader

## DESCRIPTION

The LTC<sup>®</sup>5536 is an RF power detector for RF applications operating in the 600MHz to 7GHz range. A temperature compensated Schottky diode peak detector and fast comparator are combined in a small ThinSOT<sup>™</sup> package. The supply voltage range is optimized for operation from a single cell lithium-ion or three cell NiMH battery.

The RF input voltage is peak detected using an on-chip Schottky diode. The detected voltage is compared against a reference voltage at V<sub>M</sub>.

The response time from the RF input to V<sub>OUT</sub> can be as little as 20ns. The comparator output is latched when LEN is high or is transparent when LEN is low.

The LTC5536 operates with RF input power levels from -26dBm to 12dBm.

**LT**, LTC and LT are registered trademarks of Linear Technology Corporation.  
ThinSOT is a trademark of Linear Technology Corporation.  
\*Operation at higher frequencies is possible with reduced performance.

## TYPICAL APPLICATION

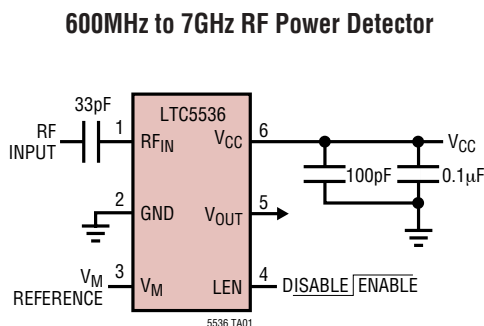

**V<sub>M</sub> Comparator Switching Voltage vs RF Input Power, 600MHz – 7GHz**

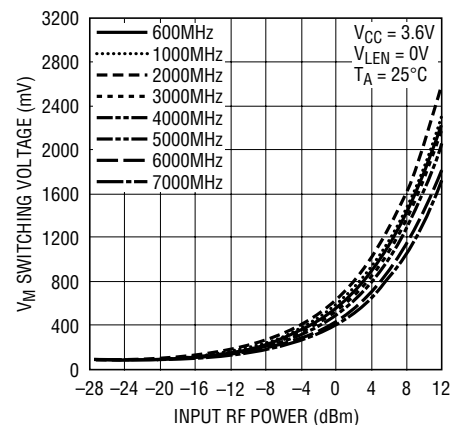

**ABSOLUTE MAXIMUM RATINGS**

(Note 1)

$V_{CC}$ , $V_{OUT}$ , $V_M$ , LEN .....	-0.3V to 6V
RF <sub>IN</sub> Voltage .....	( $V_{CC} \pm 1.5V$ ) to 6.5V
I <sub>VOUT</sub> .....	$\pm 25mA$
Operating Temperature Range (Note 2) ..	-40°C to 85°C
Maximum Junction Temperature .....	125°C
Storage Temperature Range .....	-65°C to 150°C
Lead Temperature (Soldering, 10 sec).....	300°C

**PACKAGE/ORDER INFORMATION**

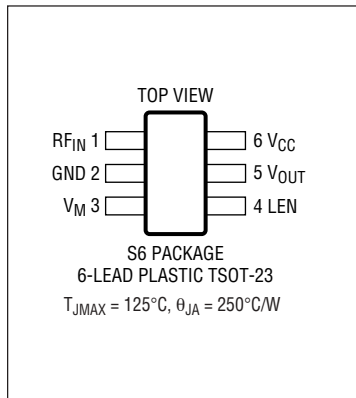
	ORDER PART NUMBER
	LTC5536ES6
	S6 PART MARKING
	LBDS

Consult LTC Marketing for parts specified with wider operating temperature ranges.

**ELECTRICAL CHARACTERISTICS**

The ● denotes the specifications which apply over the full operating temperature range, otherwise specifications are at  $T_A = 25^\circ C$ .  $V_{CC} = 3.6V$ , RF Input Signal is Off,  $V_M = 160mV$  unless otherwise noted.

PARAMETER	CONDITIONS	MIN	TYP	MAX	UNITS
$V_{CC}$ Operating Voltage		● 2.7		5.5	V
I <sub>VCC</sub> Operating Current	I <sub>VOUT</sub> = 0mA, $V_M = 0.5V$	●	2.1	3	mA
$V_{OUT} V_{OL}$ (No RF Input)	I <sub>SINK</sub> = 20mA, $V_M = 0.5V$		0.8		V
$V_{OUT} V_{OH}$ (No RF Input)	I <sub>SOURCE</sub> = 20mA, $V_M = 0V$		$V_{CC} - 0.4$		V
$V_{OUT}$ Output Current		● $\pm 15$	$\pm 20$		mA
$V_M$ Voltage Range		●		$V_{CC} - 1.8$	V
$V_M$ Input Current		● -0.5		0.5	$\mu A$
$V_M$ Switch Point (No RF Input)	$V_{OUT}$ Low to High $V_{OUT}$ High to Low	● 65	100 90	135	mV mV
LEN Input Current	LEN = 3.6V	●		42	$\mu A$
LEN Switch Point	Low to High High to Low	● 1.5		0.5	V V
RF <sub>IN</sub> Input Frequency Range	(Note 5)		600 to 7000		MHz
RF <sub>IN</sub> Input Power Range	RF Frequency = 600MHz to 7GHz (Note 3, 4) $V_{CC} = 2.7V$ to 5.5V		-26 to 12		dBm
RF <sub>IN</sub> AC Input Resistance	F = 1000MHz, Pin = -25dBm		220		$\Omega$
RF <sub>IN</sub> Input Shunt Capacitance	F = 1000MHz, Pin = -25dBm		0.65		pF
Response Time	$\Delta V_{RF} = 1V_{P-P}$ , $f_{RF} = 1000MHz$ , $V_M = 0.15V$ , $V_{OUT}$ Low to High Transition		20		ns
$t_r V_{OUT}$ Rise Time	0.5V to 3V		2		ns
$t_f V_{OUT}$ Fall Time	3V to 0.5V		2		ns

**Note 1:** Absolute Maximum Ratings are those values beyond which the life of a device may be impaired.

**Note 2:** Specifications over the -40°C to 85°C operating temperature range are assured by design, characterization and correlation with statistical process controls.

**Note 3:** RF performance is tested at 1800MHz.

**Note 4:** Guaranteed by design.

**Note 5:** Operation at higher frequencies is possible with reduced performance. Consult factory for more information.

# TYPICAL PERFORMANCE CHARACTERISTICS

**Supply Current vs Supply Voltage**  
RF Input Signal Off,  $V_{LEN} = 0V$

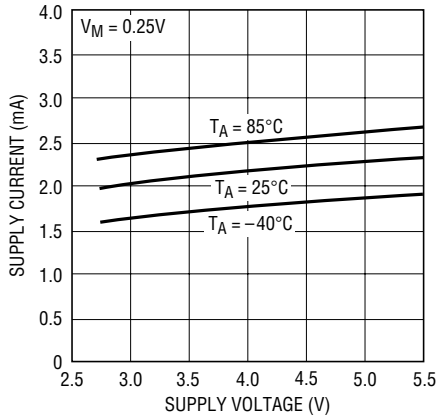

5536 G01

**Supply Current vs Supply Voltage**  
RF Input Signal Off,  $V_{LEN} = V_{CC}$

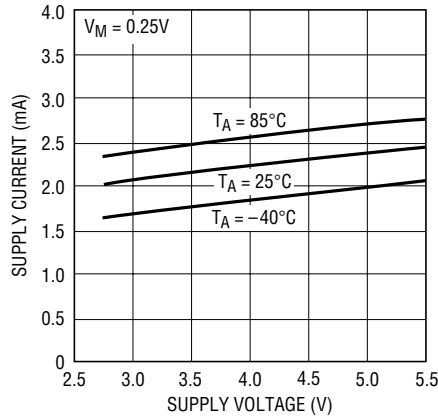

5536 G02

**$V_M$  Comparator Switching Voltage vs RF Input Power 600MHz**

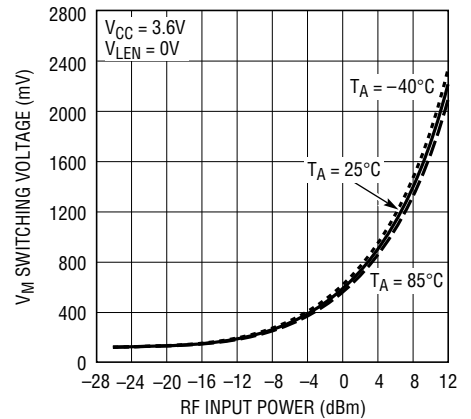

5536 G03

**$V_M$  Comparator Switching Voltage vs RF Input Power 1000MHz**

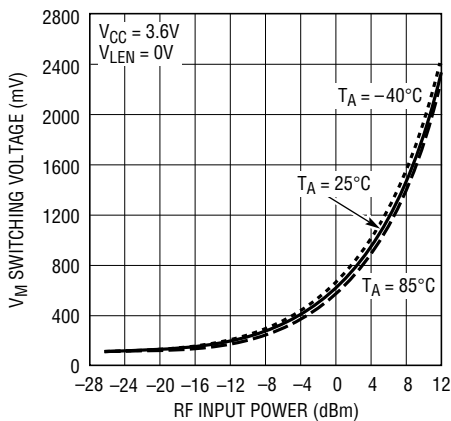

5536 G04

**$V_M$  Comparator Switching Voltage vs RF Input Power 2000MHz**

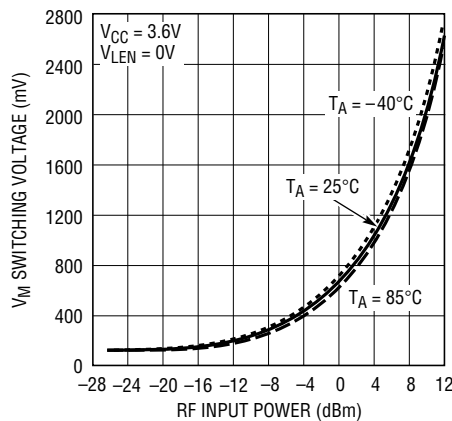

5536 G05

**$V_M$  Comparator Switching Voltage vs RF Input Power 3000MHz**

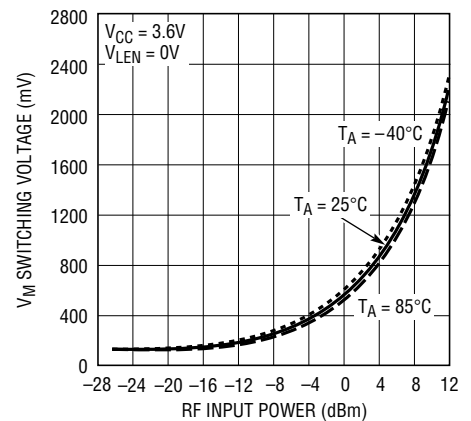

5536 G06

**$V_M$  Comparator Switching Voltage vs RF Input Power 4000MHz**

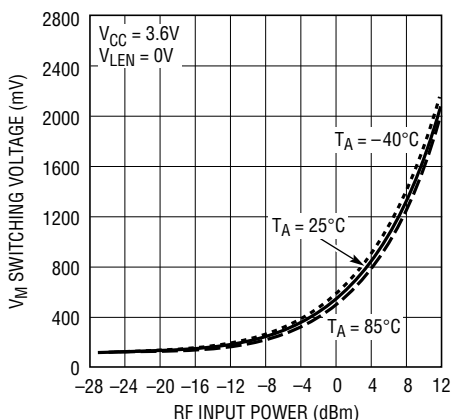

5536 G07

**$V_M$  Comparator Switching Voltage vs RF Input Power 5000MHz**

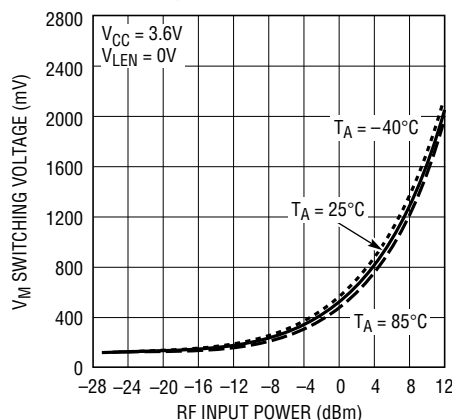

5536 G08

**$V_M$  Comparator Switching Voltage vs RF Input Power 6000MHz**

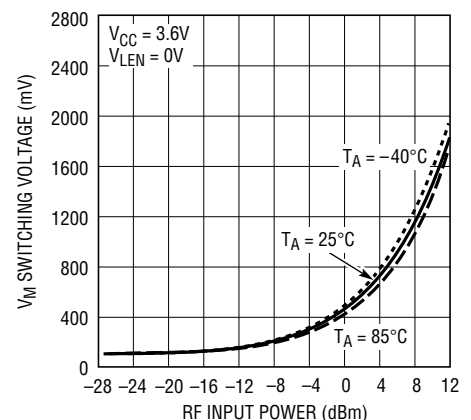

5536 G09

TYPICAL PERFORMANCE CHARACTERISTICS

**$V_M$  Comparator Switching Voltage vs RF Input Power 7000MHz**

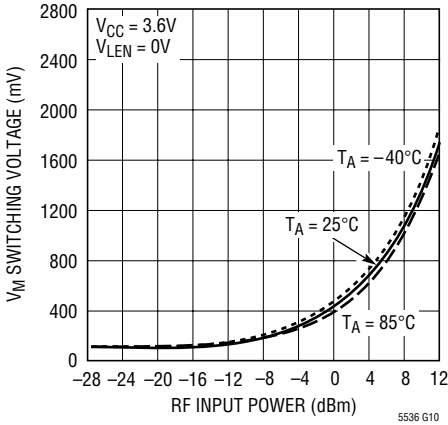

**Slope of  $V_M$  Comparator Switching Voltage vs RF Input Power at 600MHz**

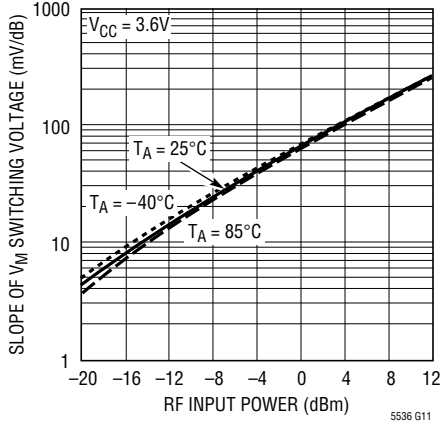

**Slope of  $V_M$  Comparator Switching Voltage vs RF Input Power at 1000MHz**

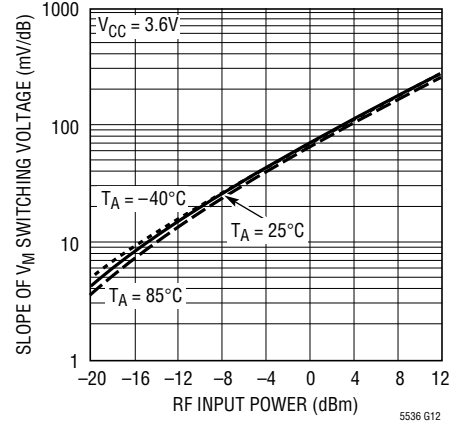

**Slope of  $V_M$  Comparator Switching Voltage vs RF Input Power at 2000MHz**

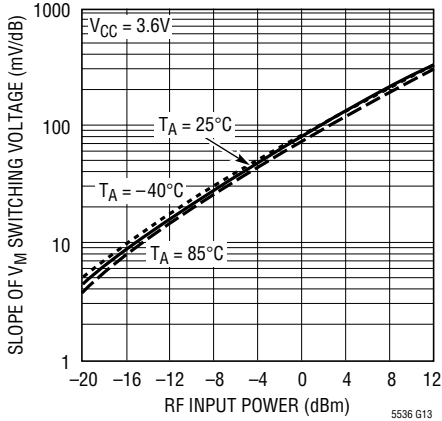

**Slope of  $V_M$  Comparator Switching Voltage vs RF Input Power at 3000MHz**

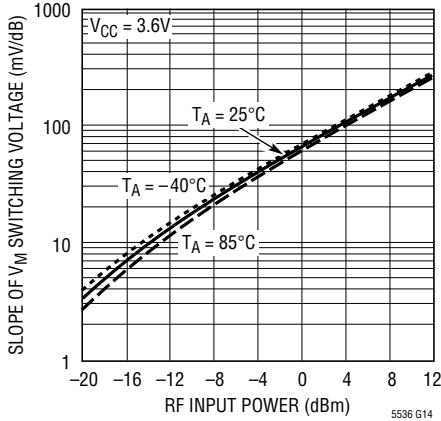

**Slope of  $V_M$  Comparator Switching Voltage vs RF Input Power at 4000MHz**

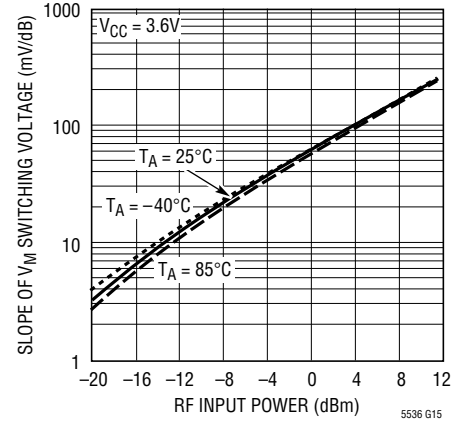

**Slope of  $V_M$  Comparator Switching Voltage vs RF Input Power at 5000MHz**

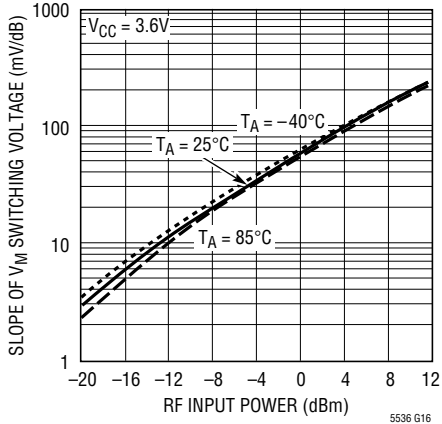

**Slope of  $V_M$  Comparator Switching Voltage vs RF Input Power at 6000MHz**

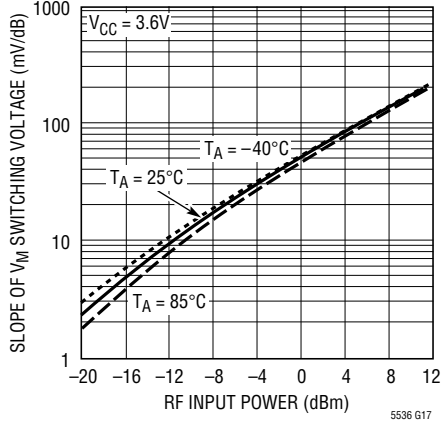

**Slope of  $V_M$  Comparator Switching Voltage vs RF Input Power at 7000MHz**

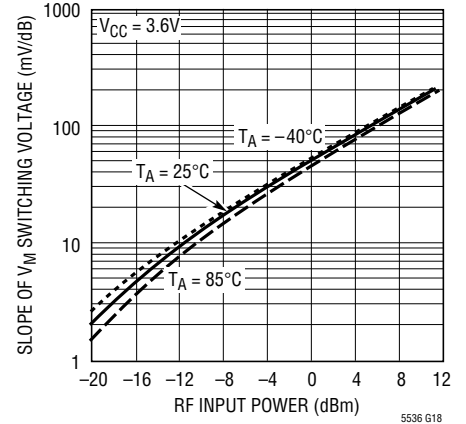

## TYPICAL PERFORMANCE CHARACTERISTICS

RF<sub>IN</sub> Input Impedance (P<sub>in</sub> = -25dBm, V<sub>CC</sub> = 3.6V, T<sub>A</sub> = 25°C)

FREQUENCY (GHz)	RESISTANCE (Ω)	REACTANCE (Ω)
0.60	152.91	-116.16
0.79	123.50	-111.98
0.98	102.42	-105.03
1.18	86.70	-96.82
1.37	74.80	-88.72
1.56	65.80	-80.93
1.75	58.82	-73.67
1.94	53.15	-67.22
2.14	48.80	-60.93
2.33	45.86	-55.62
2.52	42.88	-51.52
2.71	40.43	-47.41
2.90	38.21	-43.52
3.10	35.73	-39.58
3.29	34.09	-35.73
3.48	32.16	-32.68
3.67	30.77	-28.25
3.86	30.30	-26.77
4.06	27.45	-22.91
4.25	25.57	-19.02
4.44	24.59	-15.00
4.63	23.92	-11.08
4.82	23.62	-7.35
5.02	23.45	-3.68
5.21	23.24	-0.09
5.40	23.30	3.53
5.59	23.66	7.08
5.78	24.20	10.37
5.98	25.03	13.36
6.17	25.27	15.93
6.36	25.06	18.97
6.55	25.08	22.50
6.74	25.29	26.13
6.87	25.59	28.64
7.00	25.99	31.20

S11 Forward Reflection  
Impedance

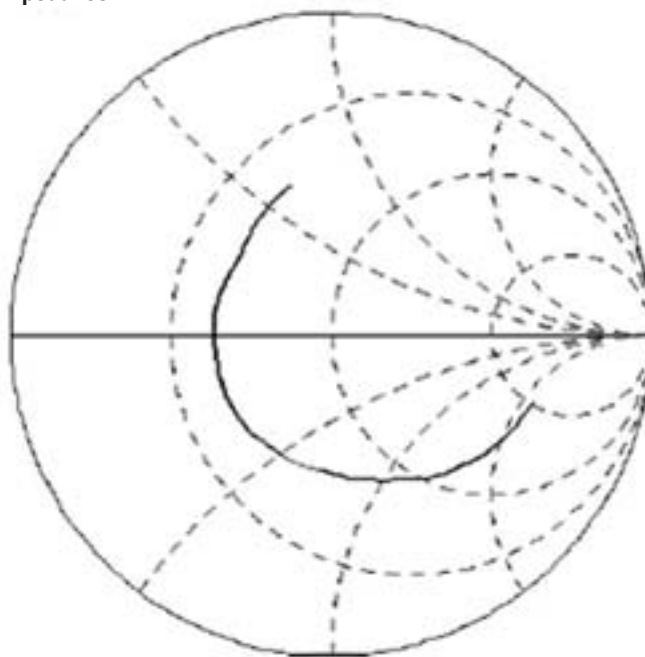

0.6GHz-7.0GHz

5536 G19

## TYPICAL PERFORMANCE CHARACTERISTICS

RF<sub>IN</sub> Input Impedance (P<sub>in</sub> = 0dBm, V<sub>CC</sub> = 3.6V, T<sub>A</sub> = 25°C)

FREQUENCY (GHz)	RESISTANCE (Ω)	REACTANCE (Ω)
0.60	171.28	-163.91
0.79	132.48	-151.40
0.98	106.05	-136.13
1.18	87.75	-122.84
1.37	74.19	-110.86
1.56	64.17	-100.09
1.75	56.84	-91.10
1.94	50.77	-81.95
2.14	46.69	-74.70
2.33	43.66	-68.01
2.52	40.24	-62.54
2.71	38.17	-58.00
2.90	35.92	-53.32
3.10	33.68	-48.71
3.29	32.26	-44.12
3.48	30.54	-40.76
3.67	28.02	-36.26
3.86	29.16	-33.25
4.06	25.08	-30.21
4.25	23.57	-25.89
4.44	22.55	-21.78
4.63	21.87	-17.40
4.82	21.40	-13.49
5.02	21.14	-9.71
5.21	20.92	-5.99
5.40	21.01	-2.54
5.59	21.33	1.33
5.78	21.82	4.57
5.98	22.46	7.95
6.17	22.63	10.65
6.36	22.34	13.54
6.55	22.31	17.14
6.74	22.53	20.99
6.87	22.80	23.53
7.00	23.17	25.92

S11 Forward Reflection  
Impedance

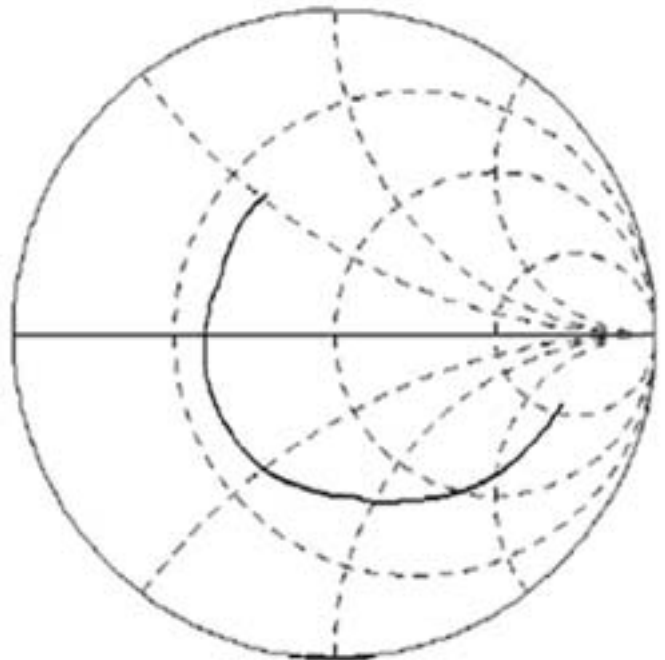

0.6GHz–7.0GHz

5536 G20



## APPLICATIONS INFORMATION

### Operation

The LTC5536 is configured as a fast detector and high speed comparator for RF power detection and RF power alarms. The product integrates several functions to provide RF power detection over frequencies ranging from 600MHz to 7GHz. These functions include an RF Schottky diode peak detector, a level shift amplifier to convert the RF input signal to low frequency, and a fast comparator. The LTC5536 provides a comparator reference input  $V_M$  and a latch enable input LEN.

### RF Detector

The internal RF Schottky diode peak detector and level shift amplifier convert the RF input signal to a low frequency signal. The detector demonstrates excellent efficiency and linearity over a wide range of input power. The Schottky diode is biased at about 55 $\mu$ A, and drives a 15pF internal peak detector capacitor.

### High Speed Comparator

The fast internal comparator compares the external reference voltage at  $V_M$  to the internal signal voltage from the peak detector, and produces the output signal,  $V_{OUT}$ . The internal peak detector voltage is factory trimmed to 100mV with no RF signal present. The comparator has approximately 10mV of hysteresis, with a typical  $V_{OUT}$  low-to-high switching point of 100mV and a  $V_{OUT}$  high-to-low switching point of 90mV with no RF signal present.

The comparator also has a built-in latch. This will cause the  $V_{OUT}$  output to latch high on a positive comparator transition (increasing RF power), when the LEN pin is high, as indicated in the waveforms of Figure 1. For transparent

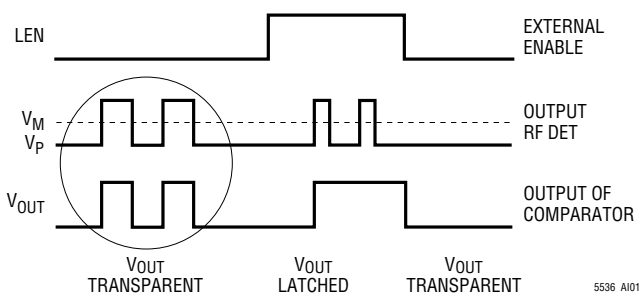

Figure 1. LTC5536 LEN Function Waveform

operation of the comparator (no latching action), the LEN pin should be connected to ground.

The comparator output ( $V_{OUT}$ ) rise and fall times are approximately 2ns (unloaded). The propagation delay for the comparator alone was characterized by applying a continuous 2GHz RF signal to the  $RF_{IN}$  input. Then a 1MHz square wave (0V to 2.5V) was applied to the  $V_M$  input to switch the comparator. Note that there is a signal inversion, because the  $V_M$  pin is connected internally to the negative comparator input. The time delay from the transition edge of the square wave at the  $V_M$  input to the corresponding  $V_{OUT}$  output transition (rising or falling) is shown in Table 1.

Table 1. Comparator Propagation Delay

RF Input Level (dBm)	$V_{OUT}$ Rising Edge Delay (ns)	$V_{OUT}$ Falling Edge Delay (ns)
-10	38.5	36
0	24	40
10	20	86

### Overall Propagation Delay and Response Time

Figure 2 shows measurements of total propagation delay from the  $RF_{IN}$  signal input to the  $V_{OUT}$  output of the LTC5536, plotted as a function of RF input power. The response is shown for RF Signal Absent-to-RF Signal Present Transitions (Rising Edge  $V_{OUT}$ ), and for RF Signal Present-to-RF Signal Absent Transitions (Falling Edge  $V_{OUT}$ ). The LTC5536's RF detector is optimized as a positive peak detector. Consequently, the device responds to a rising signal at the RF input much more rapidly than to a falling signal. Correspondingly, Rising Edge  $V_{OUT}$  transitions are much more rapid than Falling Edge transitions, as shown in Figure 2. The minimum propagation delay is about 20ns at room temperature, in response to strong overdrive conditions at the  $RF_{IN}$  input. These results were measured by applying a 1GHz RF signal that was amplitude modulated by a 1MHz square wave with 50% duty cycle. An example time domain waveform is shown in Figure 3.



## APPLICATIONS INFORMATION

### Higher Frequency Operation

Operation of the LTC5536 at higher frequencies, to 12GHz or above, is possible with reduced performance. Figure 4 plots the  $V_M$  switching voltage vs  $RF_{IN}$  input power with a 12GHz RF input. Consult factory for more information.

### High Speed Design Techniques

As with all high speed comparators, careful attention to printed circuit board layout and design is important in order to ensure signal integrity. The most common problem involves insufficient power supply bypassing. Bypass capacitors should be placed as close as possible to the LTC5536  $V_{CC}$  pin. A good high frequency capacitor, such

as a 100pF ceramic, is recommended, in parallel with a larger capacitor (e.g., 0.1 $\mu$ F).

Avoid ground bounce problems by proper attention to grounding, including the use of a low impedance ground plane. If necessary, edge transition time at the comparator output,  $V_{OUT}$ , may be increased by means of an output R-C low pass filter.

Poor trace routes and high source impedances are also common sources of problems. Keep all trace lengths as short as possible and avoid running the output trace close to the  $V_M$  or the LEN traces on the PC board. Also, keep the  $V_M$  source impedance low and decouple the  $V_M$  pin with an appropriate capacitor if necessary.

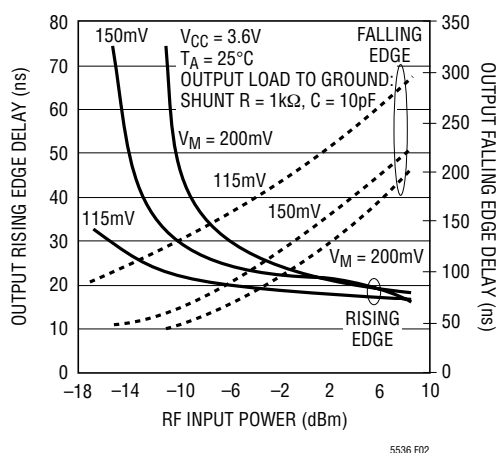

Figure 2. Propagation Delay vs RF Input Power

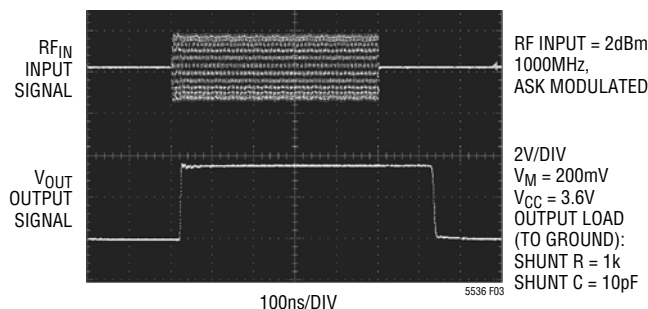

Figure 3. Propagation Delay Example

APPLICATIONS INFORMATION

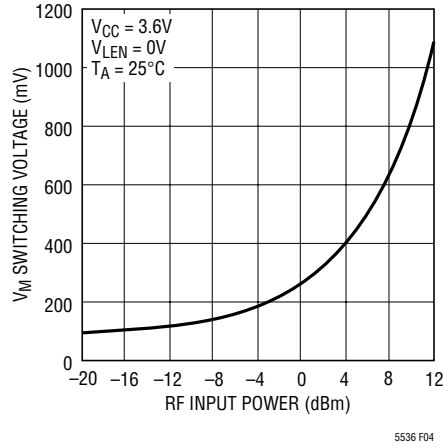

Figure 4.  $V_M$  Comparator Switching Voltage vs RF Input Power at 12GHz

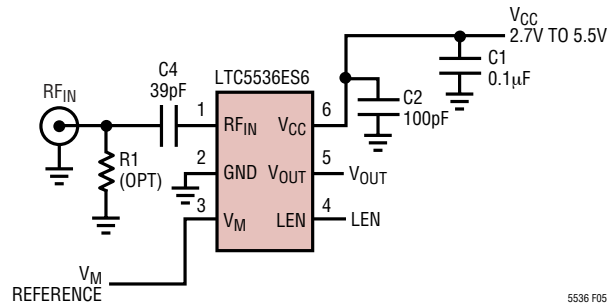
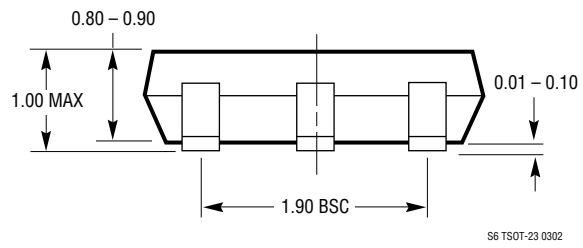
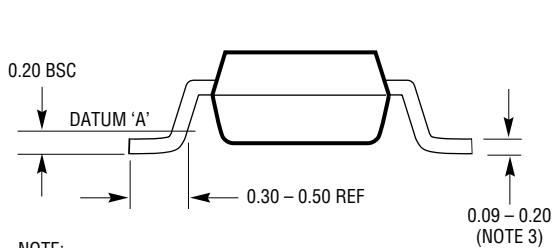
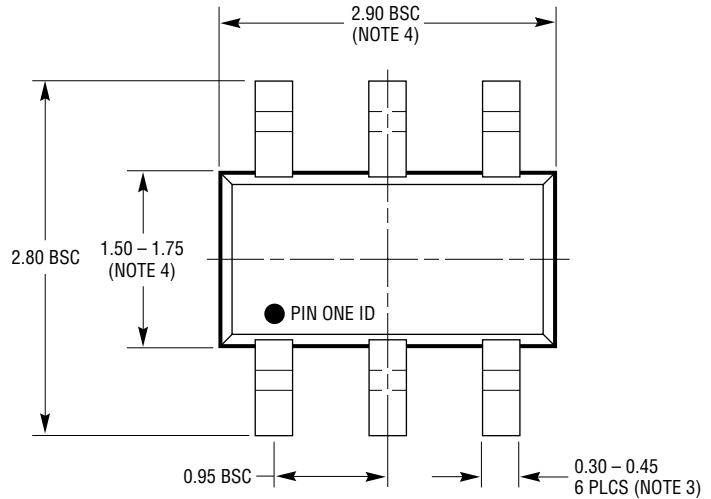
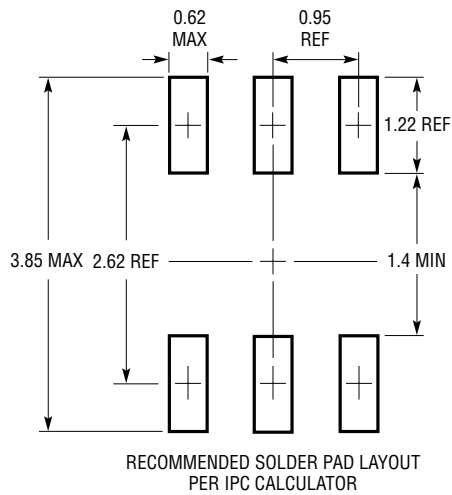

Figure 5. Demo Board Schematic

# PACKAGE DESCRIPTION

## S6 Package 6-Lead Plastic TSOT-23 (Reference LTC DWG # 05-08-1636)



- NOTE:
1. DIMENSIONS ARE IN MILLIMETERS
  2. DRAWING NOT TO SCALE
  3. DIMENSIONS ARE INCLUSIVE OF PLATING
  4. DIMENSIONS ARE EXCLUSIVE OF MOLD FLASH AND METAL BURR
  5. MOLD FLASH SHALL NOT EXCEED 0.254mm
  6. JEDEC PACKAGE REFERENCE IS MO-193

S6 TSOT-23 0302

**RELATED PARTS**

PART NUMBER	DESCRIPTION	COMMENTS
<b>Infrastructure</b>		
LT <sup>®</sup> 5511	High Linearity Upconverting Mixer	RF Output to 3GHz, 17dBm IIP3, Integrated LO Buffer
LT5512	DC-3GHz High Signal Level Downconverting Mixer	DC to 3GHz, 21dBm IIP3, Integrated LO Buffer
LT5515	1.5GHz to 2.5GHz Direct Conversion Quadrature Demodulator	20dBm IIP3, Integrated LO Quadrature Generator
LT5516	0.8GHz to 1.5GHz Direct Conversion Quadrature Demodulator	21.5dBm IIP3, Integrated LO Quadrature Generator
LT5517	40MHz to 900MHz Direct Conversion Quadrature Demodulator	21dBm IIP3, Integrated LO Quadrature Generator
LT5519	0.7GHz to 1.4GHz High Linearity Upconverting Mixer	17.1dBm IIP3, 50Ω Single Ended RF and LO Ports
LT5520	1.3GHz to 2.3GHz High Linearity Upconverting Mixer	15.9dBm IIP3, 50Ω Single Ended RF and LO Ports
LT5521	3.7GHz Very High Linearity Mixer	24.2dBm IIP3 at 1.95GHz, 12.5dB NF, -42dBm LO Leakage
LT5522	600MHz to 2.7GHz High Linearity Downconverting Mixer	4.5V to 5.25V Supply, 25dBm IIP3 at 900MHz, NF = 12.5dB, 50Ω Single-Ended RF and LO Ports
LT5525	0.9GHz to 2.5GHz High Linearity, Low Power Downconverting Mixer	17.6dBm IIP3 at 1.9GHz, On-Chip 50Ω RF and LO Matching, I <sub>CC</sub> = 28mA
LT5526	Broadband High Linearity, Low Power Downconverting Mixer	16.5dBm IIP3 at 0.9GHz, 11dB NF at 0.9GHz, I <sub>CC</sub> = 28mA
LT5528	1.6GHz to 2.45GHz High Linearity Direct Quadrature Modulator	21.8dBm OIP3 at 2GHz, -159dBm/Hz, Noise Floor, All Ports 50Ω Matched, Single-Ended RF and LO Ports
<b>RF Power Detectors</b>		
LT5504	800MHz to 2.7GHz RF Measuring Receiver	80dB Dynamic Range, Temperature Compensated, 2.7V to 5.25V Supply
LTC5505	300MHz to 3GHz RF Power Detectors	LTC5505-1: -28dBm to 18dBm Range, LTC5505-2: -32dBm to 12dBm Range, Temperature Compensated, 2.7V to 6V Supply
LTC5507	100kHz to 1000MHz RF Power Detector	-34dBm to 14dBm Range, Temperature Compensated, 2.7V to 6V Supply
LTC5508	300MHz to 7GHz RF Power Detector	-32dBm to 12dBm Range, Temperature Compensated, SC70 Package
LTC5509	300MHz to 3GHz RF Power Detector	36dB Dynamic Range, Temperature Compensated, SC70 Package
LTC5530	300MHz to 7GHz Precision RF Power Detector	Precision V <sub>OUT</sub> Offset Control, Shutdown and Adjustable Gain
LTC5531	300MHz to 7GHz Precision RF Power Detector	Precision V <sub>OUT</sub> Offset Control, Shutdown and Adjustable Offset
LTC5532	300MHz to 7GHz Precision RF Power Detector	Precision V <sub>OUT</sub> Offset Control, Adjustable Gain and Offset
LT5534	50MHz to 3GHz RF Power Detector	60dB Dynamic Range, Temperature Compensated, SC70 Package
LTC5535	300MHz to 7GHz Precision RF Detector with 12MHz Amplifier	Precision V <sub>OUT</sub> Offset Control, Adjustable Gain and Offset
<b>RF Power Controllers</b>		
LTC1757A	RF Power Controller	Multiband GSM/DCS/GPRS Mobile Phones
LTC1758	RF Power Controller	Multiband GSM/DCS/GPRS Mobile Phones
LTC1957	RF Power Controller	Multiband GSM/DCS/GPRS Mobile Phones
LTC4400	SOT-23 RF PA Controller	Multiband GSM/DCS/GPRS Phones, 45dB Dynamic Range, 450kHz Loop BW
LTC4401	SOT-23 RF PA Controller	Multiband GSM/DCS/GPRS Phones, 45dB Dynamic Range, 250kHz Loop BW
LTC4402	Multiband RF Power Controller	Multiband GSM/GPRS/EDGE Mobile Phones LTC4402-1: Single Channel Output Control LTC4402-2: Dual Channel Output Control
LTC4403	RF Power Controller for EDGE/TDMA	Multiband GSM/GPRS/EDGE Mobile Phones, 250kHz Loop BW