

### FEATURES

**225 ps Propagation Delay through the Switch**  
**4.5  $\Omega$  Switch Connection between Ports**  
**Data Rate 1.244 Gbps**  
**2.5 V/3.3 V Supply Operation**  
**Selectable Level Shifting/Translation**  
**Level Translation**  
    **3.3 V to 2.5 V**  
    **3.3 V to 1.8 V**  
    **2.5 V to 1.8 V**  
**Small Signal Bandwidth 610 MHz**  
**8-Lead SOT-23 Package**

### APPLICATIONS

**3.3 V to 1.8 V Voltage Translation**  
**3.3 V to 2.5 V Voltage Translation**  
**2.5 V to 1.8 V Voltage Translation**  
**Docking Stations**  
**Memory Switching**  
**Analog Switch Applications**

### GENERAL DESCRIPTION

The ADG3249 is a 2.5 V or 3.3 V, high performance 2:1 multiplexer/demultiplexer bus switch. It is designed on a low voltage CMOS process, which provides low power dissipation yet gives high switching speed and very low on resistance. This allows the input to be connected to the output without additional propagation delay or generating additional ground bounce noise.

Each switch of the ADG3249 conducts equally well in both directions when on. The ADG3249 exhibits break-before-make switching action, preventing momentary shorting when switching channels.

This device is ideal for applications requiring level translation. When operated from a 3.3 V supply, level translation from 3.3 V inputs to 2.5 V outputs is allowed. Similarly, if the device is operated from 2.5 V supply and 2.5 V inputs are applied, the device will translate the outputs to 1.8 V. In addition, a level translating pin ( $\overline{\text{SEL}}$ ) is included. When  $\overline{\text{SEL}}$  is low,  $V_{\text{CC}}$  is reduced internally, allowing for level translating between 3.3 V inputs and 1.8 V outputs.

The ADG3249 is available in a tiny 8-lead SOT-23 package.

### FUNCTIONAL BLOCK DIAGRAM

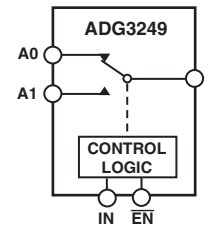

### PRODUCT HIGHLIGHTS

1. 3.3 V or 2.5 V supply operation.
2. Extremely low propagation delay through switch.
3. 4.5  $\Omega$  switches connect inputs to outputs.
4. Tiny SOT-23 package.

### REV. 0

Information furnished by Analog Devices is believed to be accurate and reliable. However, no responsibility is assumed by Analog Devices for its use, nor for any infringements of patents or other rights of third parties that may result from its use. No license is granted by implication or otherwise under any patent or patent rights of Analog Devices. Trademarks and registered trademarks are the property of their respective companies.

# ADG3249—SPECIFICATIONS<sup>1</sup> ( $V_{CC} = 2.3\text{ V to }3.6\text{ V}$ , $GND = 0\text{ V}$ , all specifications $T_{MIN}$ to $T_{MAX}$ , unless otherwise noted.)

Parameter	Symbol	Conditions	B Version			Unit
			Min	Typ <sup>2</sup>	Max	
<b>DC ELECTRICAL CHARACTERISTICS</b>						
Input High Voltage	$V_{INH}$	$V_{CC} = 2.7\text{ V to }3.6\text{ V}$	2.0			V
	$V_{INH}$	$V_{CC} = 2.3\text{ V to }2.7\text{ V}$	1.7			V
Input Low Voltage	$V_{INL}$	$V_{CC} = 2.7\text{ V to }3.6\text{ V}$			0.8	V
	$V_{INL}$	$V_{CC} = 2.3\text{ V to }2.7\text{ V}$			0.7	V
Input Leakage Current	$I_I$			$\pm 0.01$	$\pm 1$	$\mu\text{A}$
OFF State Leakage Current	$I_{OZ}$	$0 \leq A, B \leq V_{CC}$		$\pm 0.01$	$\pm 1$	$\mu\text{A}$
ON State Leakage Current		$0 \leq A, B \leq V_{CC}$		$\pm 0.01$	$\pm 1$	$\mu\text{A}$
Maximum Pass Voltage	$V_P$	$V_A/V_B = V_{CC} = \overline{\text{SEL}} = 3.3\text{ V}$ , $I_O = -5\text{ }\mu\text{A}$	2.0	2.5	2.9	V
		$V_A/V_B = V_{CC} = \overline{\text{SEL}} = 2.5\text{ V}$ , $I_O = -5\text{ }\mu\text{A}$	1.5	1.8	2.1	V
		$V_A/V_B = V_{CC} = 3.3\text{ V}$ , $\overline{\text{SEL}} = 0\text{ V}$ , $I_O = -5\text{ }\mu\text{A}$	1.5	1.8	2.1	V
<b>CAPACITANCE<sup>3</sup></b>						
A Port Off Capacitance	$C_A\text{ OFF}$	$f = 1\text{ MHz}$ ; $\overline{\text{EN}} = V_{CC}$		3.5		pF
B Port Off Capacitance	$C_B\text{ OFF}$	$f = 1\text{ MHz}$ ; $\overline{\text{EN}} = V_{CC}$		4.5		pF
A, B Port On Capacitance	$C_A, C_B\text{ ON}$	$f = 1\text{ MHz}$		8.5		pF
Control Input Capacitance	$C_{IN}, C_{\overline{\text{SEL}}}$	$f = 1\text{ MHz}$		4		pF
	$C_{\overline{\text{EN}}}$	$f = 1\text{ MHz}$		6.5		pF
<b>SWITCHING CHARACTERISTICS<sup>3</sup></b>						
Propagation Delay A to B or B to A, $t_{PD}$ <sup>4</sup>	$t_{PHL}, t_{PLH}$	$C_L = 50\text{ pF}$ , $V_{CC} = \overline{\text{SEL}} = 3\text{ V}$			0.225	ns
Propagation Delay Matching <sup>5</sup>					5	ps
Bus Enable Time $\overline{\text{EN}}$ to A or B <sup>6</sup>	$t_{PZH}, t_{PZL}$	$V_{CC} = 3.0\text{ V to }3.6\text{ V}$ ; $\overline{\text{SEL}} = V_{CC}$	1	3.5	4.8	ns
Bus Disable Time $\overline{\text{EN}}$ to A or B <sup>6</sup>	$t_{PHZ}, t_{PLZ}$	$V_{CC} = 3.0\text{ V to }3.6\text{ V}$ ; $\overline{\text{SEL}} = V_{CC}$	1	5.5	8.2	ns
Bus Enable Time $\overline{\text{EN}}$ to A or B <sup>6</sup>	$t_{PZH}, t_{PZL}$	$V_{CC} = 3.0\text{ V to }3.6\text{ V}$ ; $\overline{\text{SEL}} = 0\text{ V}$	1	3.2	4.5	ns
Bus Disable Time $\overline{\text{EN}}$ to A or B <sup>6</sup>	$t_{PHZ}, t_{PLZ}$	$V_{CC} = 3.0\text{ V to }3.6\text{ V}$ ; $\overline{\text{SEL}} = 0\text{ V}$	1	4.5	7.7	ns
Bus Enable Time $\overline{\text{EN}}$ to A or B <sup>6</sup>	$t_{PZH}, t_{PZL}$	$V_{CC} = 2.3\text{ V to }2.7\text{ V}$ ; $\overline{\text{SEL}} = V_{CC}$	1	3.5	4.6	ns
Bus Disable Time $\overline{\text{EN}}$ to A or B <sup>6</sup>	$t_{PHZ}, t_{PLZ}$	$V_{CC} = 2.3\text{ V to }2.7\text{ V}$ ; $\overline{\text{SEL}} = V_{CC}$	1	4	5.8	ns
Break-before-Make Time	$t_{BBM}$	$R_L = 510\text{ }\Omega$ , $C_L = 50\text{ pF}$	5	10		ns
Transition Time	$t_{TRANS}$	$R_L = 510\text{ }\Omega$ , $C_L = 50\text{ pF}$ ; $\overline{\text{SEL}} = V_{CC}$		16	29	ns
		$R_L = 510\text{ }\Omega$ , $C_L = 50\text{ pF}$ ; $\overline{\text{SEL}} = 0\text{ V}$		15	22	ns
Maximum Data Rate		$V_{CC} = \overline{\text{SEL}} = 3.3\text{ V}$ ; $V_A/V_B = 2\text{ V}$		1.244		Gbps
Channel Jitter		$V_{CC} = \overline{\text{SEL}} = 3.3\text{ V}$ ; $V_A/V_B = 2\text{ V}$		45		ps p-p
<b>DIGITAL SWITCH</b>						
On Resistance	$R_{ON}$	$V_{CC} = 3\text{ V}$ , $\overline{\text{SEL}} = V_{CC}$ , $V_A = 0\text{ V}$ , $I_{BA} = 8\text{ mA}$	4.5	8		$\Omega$
		$V_{CC} = 3\text{ V}$ , $\overline{\text{SEL}} = V_{CC}$ , $V_A = 1.7\text{ V}$ , $I_{BA} = 8\text{ mA}$	12	28		$\Omega$
		$V_{CC} = 2.3\text{ V}$ , $\overline{\text{SEL}} = V_{CC}$ , $V_A = 0\text{ V}$ , $I_{BA} = 8\text{ mA}$	5	9		$\Omega$
		$V_{CC} = 2.3\text{ V}$ , $\overline{\text{SEL}} = V_{CC}$ , $V_A = 1\text{ V}$ , $I_{BA} = 8\text{ mA}$	9	18		$\Omega$
		$V_{CC} = 3\text{ V}$ , $\overline{\text{SEL}} = 0\text{ V}$ , $V_A = 0\text{ V}$ , $I_{BA} = 8\text{ mA}$	5	8		$\Omega$
		$V_{CC} = 3\text{ V}$ , $\overline{\text{SEL}} = 0\text{ V}$ , $V_A = 1\text{ V}$ , $I_{BA} = 8\text{ mA}$	12			$\Omega$
On Resistance Matching	$\Delta R_{ON}$	$V_{CC} = 3\text{ V}$ , $\overline{\text{SEL}} = V_{CC}$ , $V_A = 0\text{ V}$ , $I_A = 8\text{ mA}$	0.1	0.5		$\Omega$
		$V_{CC} = 3\text{ V}$ , $\overline{\text{SEL}} = 0\text{ V}$ , $V_A = 0\text{ V}$ , $I_A = 8\text{ mA}$	0.1	0.5		$\Omega$
<b>POWER REQUIREMENTS</b>						
$V_{CC}$			2.3		3.6	V
Quiescent Power Supply Current	$I_{CC}$	Digital Inputs = $0\text{ V}$ or $V_{CC}$ ; $\overline{\text{SEL}} = V_{CC}$		0.01	1	$\mu\text{A}$
		Digital Inputs = $0\text{ V}$ or $V_{CC}$ ; $\overline{\text{SEL}} = 0\text{ V}$		0.1	0.2	$\text{mA}$
Increase in $I_{CC}$ per Input <sup>7</sup>	$\Delta I_{CC}$	$V_{CC} = 3.6\text{ V}$ , $\overline{\text{EN}} = 3.0\text{ V}$ ; $\overline{\text{SEL}} = V_{CC}$ ; $I_N = V_{CC}$		0.15	8	$\mu\text{A}$

## NOTES

<sup>1</sup>Temperature range is as follows: B Version:  $-40^\circ\text{C}$  to  $+85^\circ\text{C}$ .

<sup>2</sup>Typical values are at  $25^\circ\text{C}$ , unless otherwise stated.

<sup>3</sup>Guaranteed by design, not subject to production test.

<sup>4</sup>The digital switch contributes no propagation delay other than the RC delay of the typical  $R_{ON}$  of the switch and the load capacitance when driven by an ideal voltage source. Since the time constant is much smaller than the rise/fall times of typical driving signals, it adds very little propagation delay to the system. Propagation delay of the digital switch when used in a system is determined by the driving circuit on the driving side of the switch and its interaction with the load on the driven side.

<sup>5</sup>Propagation delay matching between channels is calculated from the on resistance matching and load capacitance of  $50\text{ pF}$ .

<sup>6</sup>See Timing Measurement Information section.

<sup>7</sup>This current applies to the control pin  $\overline{\text{EN}}$  only. The A and B ports contribute no significant ac or dc currents as they transition.

Specifications subject to change without notice.

## ABSOLUTE MAXIMUM RATINGS\*

(T<sub>A</sub> = 25°C, unless otherwise noted.)

V <sub>CC</sub> to GND	-0.5 V to +4.6 V
Digital Inputs to GND	-0.5 V to +4.6 V
DC Input Voltage	-0.5 V to +4.6 V
DC Output Current	25 mA per Channel
Operating Temperature Range	
Industrial (B Version)	-40°C to +85°C
Storage Temperature Range	-65°C to +150°C
Junction Temperature	150°C
θ <sub>JA</sub> Thermal Impedance	206°C/W
Lead Temperature, Soldering (10 sec)	300°C
IR Reflow, Peak Temperature (<20 sec)	235°C

\*Stresses above those listed under Absolute Maximum Ratings may cause permanent damage to the device. This is a stress rating only; functional operation of the device at these or any other conditions above those listed in the operational sections of this specification is not implied. Exposure to absolute maximum rating conditions for extended periods may affect device reliability. Only one absolute maximum rating may be applied at any one time.

## PIN CONFIGURATION

### 8-Lead SOT-23

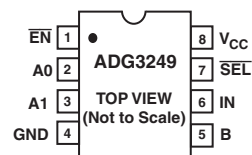

Table I. Pin Function Descriptions

Pin No.	Mnemonic	Description
1	$\overline{\text{EN}}$	Enable (Active Low)
2	A0	Port A0, Input or Output
3	A1	Port A1, Input or Output
4	GND	Ground Reference
5	B	Port B, Input or Output
6	IN	Channel Select
7	$\overline{\text{SEL}}$	Level Translation Select
8	V <sub>CC</sub>	Positive Power Supply Voltage

Table II. Truth Table

$\overline{\text{EN}}$	IN	$\overline{\text{SEL}}$ *	FUNCTION
H	X	X	Disconnect
L	L	L	A0 = B; 3.3 V to 1.8 V Level Shifting
L	L	H	A0 = B; 3.3 V to 2.5 V/2.5 V to 1.8 V Level Shifting
L	H	L	A1 = B; 3.3 V to 1.8 V Level Shifting
L	H	H	A1 = B; 3.3 V to 2.5 V/2.5 V to 1.8 V Level Shifting

\* $\overline{\text{SEL}}$  = 0 V only when V<sub>DD</sub> = 3.3 V ± 10%

## ORDERING GUIDE

Model	Temperature Range	Package Description	Package	Branding
ADG3249BRJ-R2	-40°C to +85°C	SOT-23 (Small Outline Transistor Package)	RJ-8	SHA
ADG3249BRJ-REEL	-40°C to +85°C	SOT-23 (Small Outline Transistor Package)	RJ-8	SHA
ADG3249BRJ-REEL7	-40°C to +85°C	SOT-23 (Small Outline Transistor Package)	RJ-8	SHA

## CAUTION

ESD (electrostatic discharge) sensitive device. Electrostatic charges as high as 4000 V readily accumulate on the human body and test equipment and can discharge without detection. Although the ADG3249 features proprietary ESD protection circuitry, permanent damage may occur on devices subjected to high energy electrostatic discharges. Therefore, proper ESD precautions are recommended to avoid performance degradation or loss of functionality.



## TERMINOLOGY

$V_{CC}$	Positive Power Supply Voltage.
GND	Ground (0 V) Reference.
$V_{INH}$	Minimum Input Voltage for Logic 1.
$V_{INL}$	Maximum Input Voltage for Logic 0.
$I_I$	Input Leakage Current at the Control Inputs.
$I_{OZ}$	OFF State Leakage Current. It is the maximum leakage current at the switch pin in the OFF state.
$I_{OL}$	ON State Leakage Current. It is the maximum leakage current at the switch pin in the ON state.
$V_P$	Maximum Pass Voltage. The maximum pass voltage relates to the clamped output voltage of an NMOS device when the switch input voltage is equal to the supply voltage.
$R_{ON}$	Ohmic Resistance Offered by a Switch in the ON State. It is measured at a given voltage by forcing a specified amount of current through the switch.
$\Delta R_{ON}$	ON Resistance Match between Any Two Channels, i.e., $R_{ON}$ max to $R_{ON}$ min.
$C_X$ OFF	OFF Switch Capacitance.
$C_X$ ON	ON Switch Capacitance.
$C_{IN}$ , $C_{\overline{SEL}}$ , $C_{\overline{EN}}$	Control Input Capacitance. This consists of $I_N$ , $\overline{SEL}$ , and $\overline{EN}$ .
$I_{CC}$	Quiescent Power Supply Current. This current represents the leakage current between the $V_{CC}$ and ground pins. It is measured when all control inputs are at a logic high or low level and the switches are OFF.
$\Delta I_{CC}$	Extra power supply current component for the $\overline{EN}$ control input when the input is not driven at the supplies.
$t_{PLH}$ , $t_{PHL}$	Data Propagation Delay through the Switch in the ON State. Propagation delay is related to the RC time constant $R_{ON} \times C_L$ , where $C_L$ is the load capacitance.
$t_{PZH}$ , $t_{PZL}$	Bus Enable Times. These are the times taken to cross the $V_T$ voltage at the switch output when the switch turns on in response to the control signal, $\overline{EN}$ .
$t_{PHZ}$ , $t_{PLZ}$	Bus Disable Times. These are the time taken to place the switch in the high impedance OFF state in response to the control signal. They are measured as the time taken for the output voltage to change by $V_{\Delta}$ from the original quiescent level, with reference to the logic level transition at the control input. (Refer to Figure 3 for enable and disable times.)
$t_{BBM}$	On or Off Time. Measured between the 90% points of both switches when switching from one to another.
$t_{TRANS}$	Time taken to switch from one channel to the other, measured from 50% of the IN signal to 90% of the OUT signal.
Max Data Rate	Maximum Rate at which Data Can Be Passed through the Switch.
Channel Jitter	Peak-to-Peak Value of the Sum of the Deterministic and Random Jitter of the Switch Channel.

# Typical Performance Characteristics—ADG3249

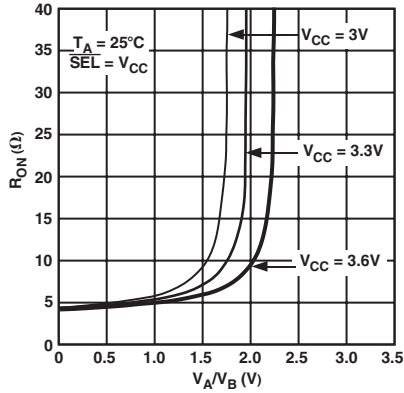

TPC 1. On Resistance vs. Input Voltage

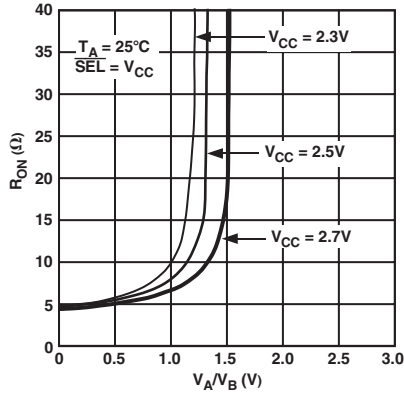

TPC 2. On Resistance vs. Input Voltage

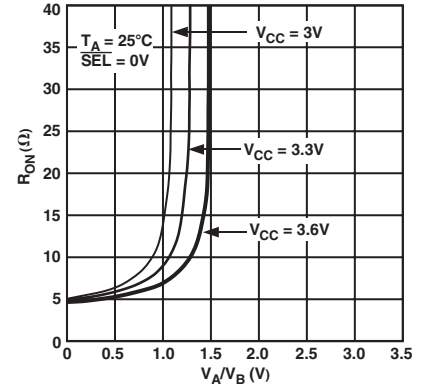

TPC 3. On Resistance vs. Input Voltage

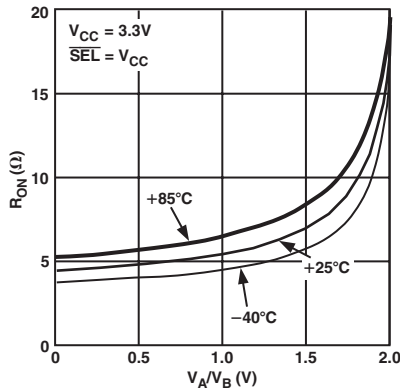

TPC 4. On Resistance vs. Input Voltage for Different Temperatures

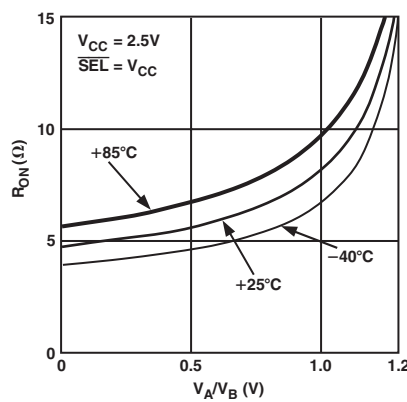

TPC 5. On Resistance vs. Input Voltage for Different Temperatures

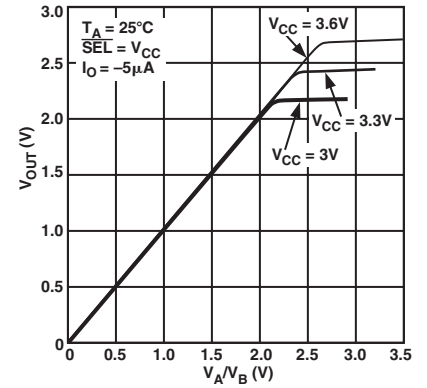

TPC 6. Pass Voltage vs.  $V_{CC}$

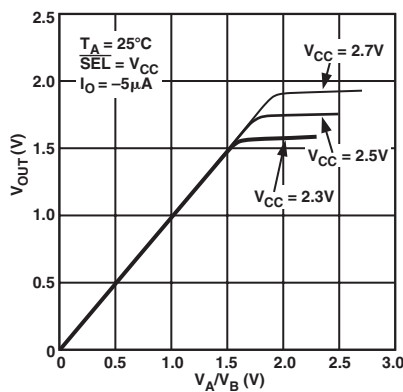

TPC 7. Pass Voltage vs.  $V_{CC}$

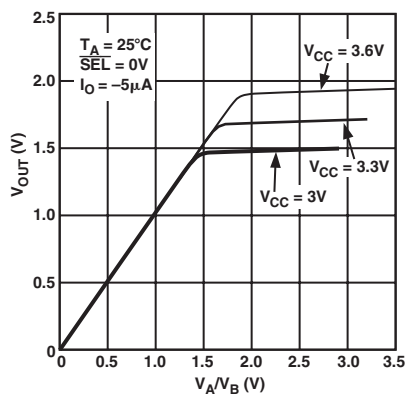

TPC 8. Pass Voltage vs.  $V_{CC}$

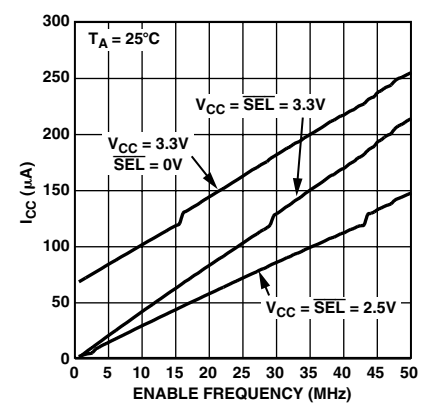

TPC 9.  $I_{CC}$  vs. Enable Frequency

# ADG3249

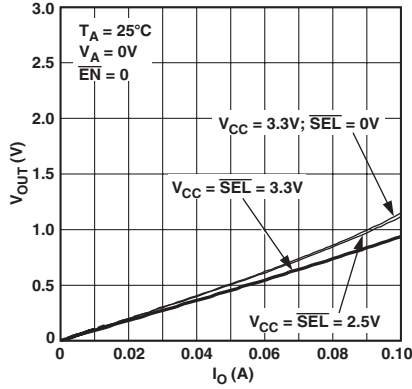

TPC 10. Output Low Characteristic

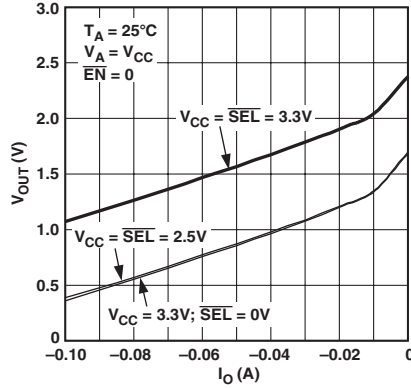

TPC 11. Output High Characteristic

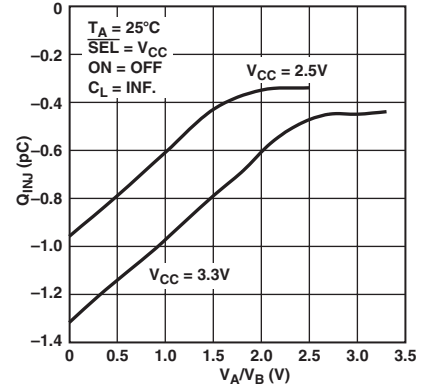

TPC 12. Charge Injection vs. Source Voltage

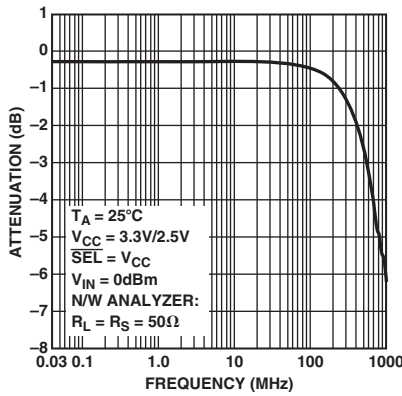

TPC 13. Bandwidth vs. Frequency

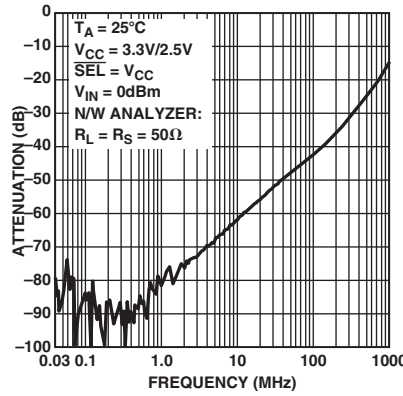

TPC 14. Crosstalk vs. Frequency

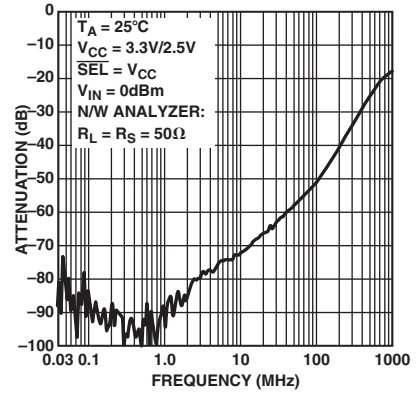

TPC 15. Off Isolation vs. Frequency

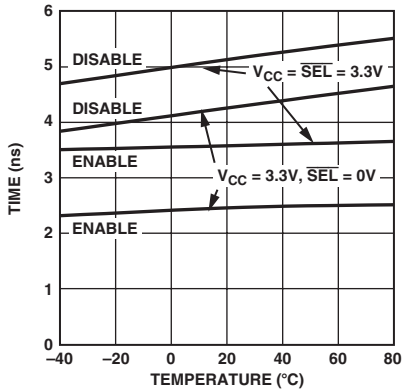

TPC 16. Enable/Disable Time vs. Temperature

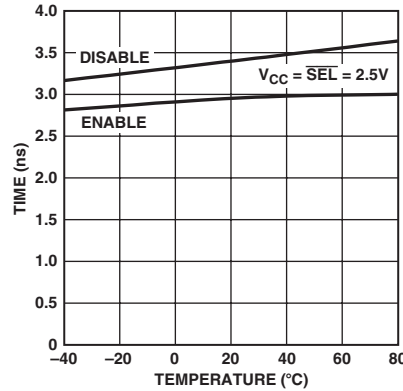

TPC 17. Enable/Disable Time vs. Temperature

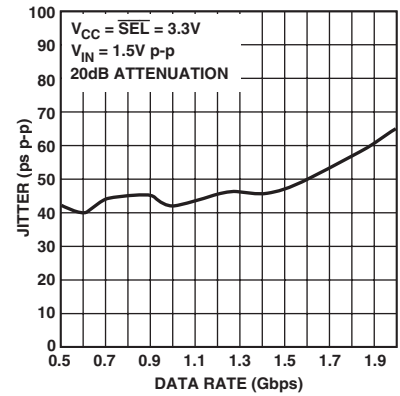

TPC 18. Jitter vs. Data Rate; PRBS 31

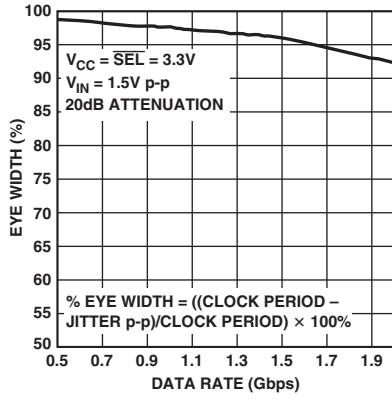

TPC 19. Eye Width vs. Data Rate; PRBS 31

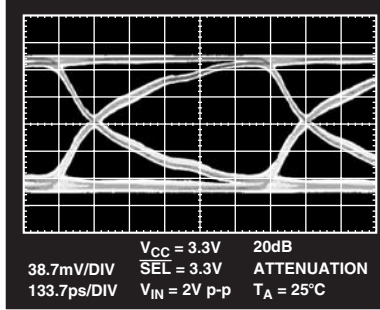

TPC 20. Eye Pattern; 1.244 Gbps,  $V_{CC} = 3.3\text{ V}$ , PRBS 31

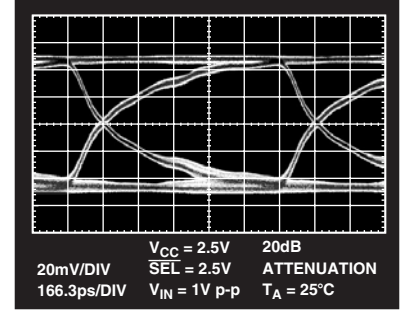

TPC 21. Eye Pattern; 1 Gbps,  $V_{CC} = 2.5\text{ V}$ , PRBS 31

# ADG3249

## TIMING MEASUREMENT INFORMATION

For the following load circuit and waveforms, the notation that is used is  $V_{IN}$  and  $V_{OUT}$  where

$$V_{IN} = V_A \text{ and } V_{OUT} = V_B \text{ or } V_{IN} = V_B \text{ and } V_{OUT} = V_A$$

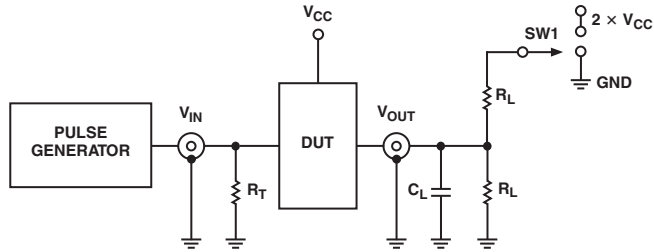

**NOTES**  
**PULSE GENERATOR FOR ALL PULSES:**  $t_R \leq 2.5\text{ns}$ ,  $t_F \leq 2.5\text{ns}$ ,  
**FREQUENCY**  $\leq 10\text{MHz}$ .  
 **$C_L$**  INCLUDES BOARD, STRAY, AND LOAD CAPACITANCES.  
 **$R_T$**  IS THE TERMINATION RESISTOR, SHOULD BE EQUAL TO  $Z_{OUT}$   
**OF THE PULSE GENERATOR.**

Figure 1. Load Circuit

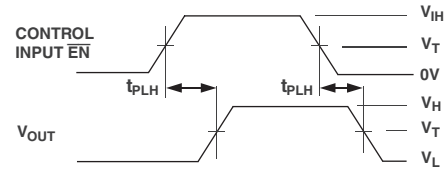

Figure 2. Propagation Delay

### Test Conditions

Symbol	$V_{CC} = 3.3\text{ V} \pm 0.3\text{ V}$ ( $\overline{\text{SEL}} = V_{CC}$ )	$V_{CC} = 2.5\text{ V} \pm 0.2\text{ V}$ ( $\overline{\text{SEL}} = V_{CC}$ )	$V_{CC} = 3.3\text{ V} \pm 0.3\text{ V}$ ( $\overline{\text{SEL}} = 0\text{ V}$ )	Unit
$R_L$	500	500	500	$\Omega$
$V_{\Delta}$	300	150	150	mV
$C_L$	50	30	30	pF
$V_T$	1.5	0.9	0.9	V

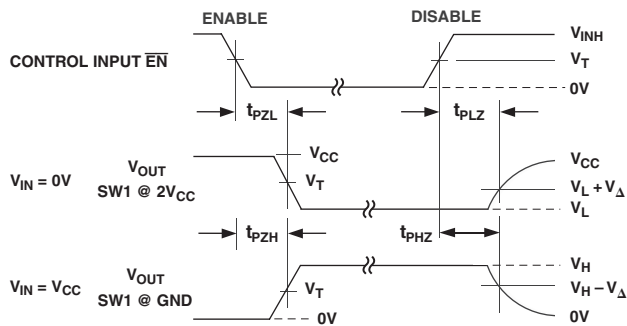

Figure 3. Enable and Disable Times

Table III. Switch Position

Test	S1
$t_{PLZ}$ , $t_{PZL}$	$2 \times V_{CC}$
$t_{PHZ}$ , $t_{PZH}$	GND



## BUS SWITCH APPLICATIONS

### Mixed Voltage Operation, Level Translation

Bus switches can provide an ideal solution for interfacing between mixed voltage systems. The ADG3249 is suitable for applications where voltage translation from 3.3 V technology to a lower voltage technology is needed. This device can translate from 2.5 V to 1.8 V, or bidirectionally from 3.3 V directly to 2.5 V.

Figure 4 shows a block diagram of a typical application in which a user needs to interface between a 3.3 V ADC and a 2.5 V microprocessor. The microprocessor may not have 3.3 V tolerant inputs, therefore placing the ADG3249 between the two devices allows the devices to communicate easily. The bus switch directly connects the two blocks, thus introducing minimal propagation delay, timing skew, or noise.

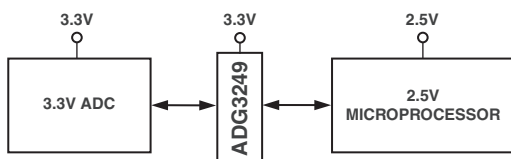

Figure 4. Level Translation between a 3.3 V ADC and a 2.5 V Microprocessor

### 3.3 V to 2.5 V Translation

When  $V_{CC}$  is 3.3 V ( $\overline{SEL} = 3.3$  V) and the input signal range is 0 V to  $V_{CC}$ , the maximum output signal will be clamped to within a voltage threshold below the  $V_{CC}$  supply. In this case, the output will be limited to 2.5 V, as shown in Figure 6. This device can be used for translation from 2.5 V to 3.3 V devices and also between two 3.3 V devices.

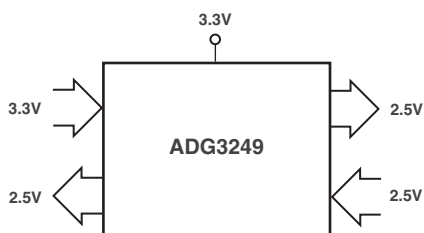

Figure 5. 3.3 V to 2.5 V Voltage Translation,  $\overline{SEL} = V_{CC}$

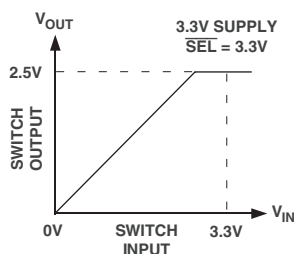

Figure 6. 3.3 V to 2.5 V Voltage Translation,  $\overline{SEL} = V_{CC}$

### 2.5 V to 1.8 V Translation

When  $V_{CC}$  is 2.5 V ( $\overline{SEL} = 2.5$  V) and the input signal range is 0 V to  $V_{CC}$ , the maximum output signal will, as before, be clamped to within a voltage threshold below the  $V_{CC}$  supply. In this case, the output will be limited to approximately 1.8 V, as shown in Figure 8.

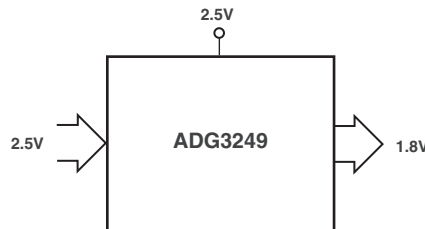

Figure 7. 2.5 V to 1.8 V Voltage Translation,  $\overline{SEL} = 2.5$  V $_{CC}$

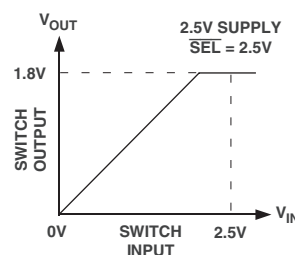

Figure 8. 2.5 V to 1.8 V Voltage Translation,  $\overline{SEL} = V_{CC}$

### 3.3 V to 1.8 V Translation

The ADG3249 offers the option of interfacing between a 3.3 V device and a 1.8 V device. This is possible through use of the  $\overline{SEL}$  pin. The  $\overline{SEL}$  pin is an active low control pin.  $\overline{SEL}$  activates internal circuitry in the ADG3242 that allows voltage translation between 3.3 V devices and 1.8 V devices.

When  $V_{CC}$  is 3.3 V and the input signal range is 0 V to  $V_{CC}$ , the maximum output signal will be clamped to 1.8 V, as shown in Figure 9. To do this, the  $\overline{SEL}$  pin must be tied to Logic 0. If  $\overline{SEL}$  is unused, it should be tied directly to  $V_{CC}$ .

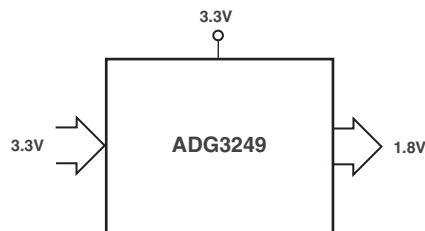

Figure 9. 3.3 V to 1.8 V Voltage Translation,  $\overline{SEL} = 0$  V

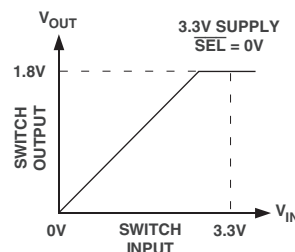

Figure 10. 3.3 V to 1.8 V Voltage Translation,  $\overline{SEL} = 0$  V

# ADG3249

## Analog Switching

Bus switches can be used in many analog switching applications, for example, video graphics. Bus switches can have lower on resistance, smaller ON and OFF channel capacitance, and thus improved frequency performance than their analog counterparts. The bus switch channel itself, consisting solely of an NMOS switch, limits the operating voltage (see TPC 1 for a typical plot), but in many cases, this does not present an issue.

## Multiplexing

Many systems, such as docking stations and memory banks, have a large number of common bus signals. Common problems faced by designers of these systems include

- Large delays caused by capacitive loading of the bus
- Noise due to simultaneous switching of the address and data bus signals

Figure 11 shows an array of memory banks in which each address and data signal is loaded by the sum of the individual loads. If a bus switch is used as shown in Figure 12, the output load on the memory address and data bits is halved. The speed at which the selected bank's data can flow is much improved because the capacitance loading is halved and the switches introduce negligible propagation delay. Bus noise is also reduced.

## High Impedance during Power-Up/Power-Down

To ensure the high impedance state during power-up or power-down,  $\overline{EN}$  should be tied to  $V_{CC}$  through a pull-up resistor; the minimum value of the resistor is determined by the current-sinking capability of the driver.

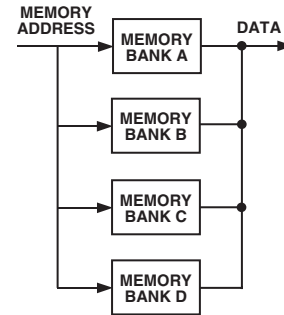

Figure 11. All Memory Banks Are Permanently Connected to the Bus

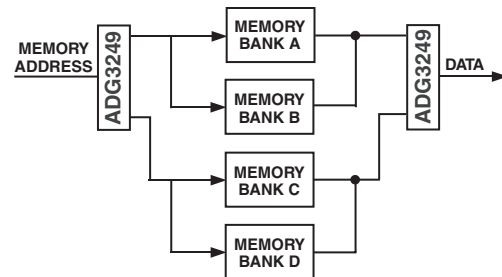

Figure 12. ADG3249 Used to Reduce Both Access Time and Noise

OUTLINE DIMENSIONS

8-Lead Small Outline Transistor Package [SOT-23]  
(RJ-8)

Dimensions shown in millimeters

