



Que-2-TXT™
Questions?
scan to text us fast



F60 PLASTIC LED SIGN RETROFIT LAMP

DOUBLE SIDE LIT, HIGH BRIGHTNESS

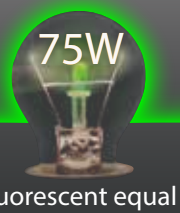

specifications

Voltage	CRI	BASE	Lens	Heat Sink	L70 hours	Ambient Temp (F)	Power Factor	IP Rating	THC	Beam Angle
⚡ 100-277 V	83	R17D	double-side plastic	aluminum	50,000	-22°- 131°	>0.9	IP 64 except for base	<15%	360°

select your lamp

Part Number	Color Temp	Consumption	Lumen Output	Efficacy	Length (pin to pin)	Diameter
GI-F60T10-CC75-R17D4	6000K	30W	3,900	130 lm / w	57.91"	1.28"

Warranty	Weight	Case QTY
6 years	2.14 lbs	10 pcs

Features

- Rotatable base
- Rated for fully enclosed fixtures
- 50,000 hour LED lifespan based on IES LM-80 results and TM-21 calculations
- Double-side powered
- Designed for double sided signs
- Replaces F60T12/HO lamps



Installation Diagram

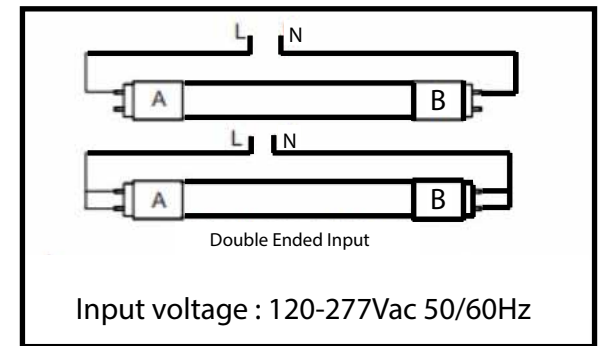

/greenignite
@greenignite



www.greenignite.com



info@greenignite.com



1-877-560-3779