

Inductors for high frequency circuits
Multilayer ceramic
MLG series



MLG1005S type



FEATURES

- Advanced monolithic structure is formed using a multilayering and sintering process with ceramic and conductive materials for high-frequency.
- Operating temperature range: -55 to +125°C

APPLICATION

- Smart phones, tablet terminals, high frequency modules (PAs, VCOs, FEMs , etc.), Bluetooth, W-LAN, UWB, tuners and other high frequency circuits for the mobile communication industry
- Application guides: [Smart phones/tablets](#)

PART NUMBER CONSTRUCTION

MLG	1005	S	0N3	B	T	000
Series name	LxWxH dimensions 1.0x0.5x0.5 mm	Product internal code	Inductance (nH)	Inductance tolerance	Packaging style	Internal code

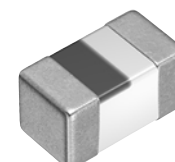

MLG1005S type

CHARACTERISTICS SPECIFICATION TABLE

L (nH)	Q Tolerance	Q min.	L, Q measuring frequency (MHz)	Self-resonant frequency		DC resistance		Rated current (mA)max.	Part No.*
				(GHz)min.	(GHz)typ.	(Ω)max.	(Ω)typ.		
0.3	± 0.1 nH	—	100	10.0	20up	0.10	0.01	1000	MLG1005S0N3BT000
0.3	± 0.2 nH	—	100	10.0	20up	0.10	0.01	1000	MLG1005S0N3CT000
0.4	± 0.1 nH	—	100	10.0	20up	0.10	0.01	1000	MLG1005S0N4BT000
0.4	± 0.2 nH	—	100	10.0	20up	0.10	0.01	1000	MLG1005S0N4CT000
0.5	± 0.1 nH	—	100	10.0	20up	0.10	0.01	1000	MLG1005S0N5BT000
0.5	± 0.2 nH	—	100	10.0	20up	0.10	0.01	1000	MLG1005S0N5CT000
0.6	± 0.1 nH	—	100	10.0	20up	0.10	0.01	1000	MLG1005S0N6BT000
0.6	± 0.2 nH	—	100	10.0	20up	0.10	0.01	1000	MLG1005S0N6CT000
0.7	± 0.1 nH	—	100	10.0	18.7	0.10	0.02	1000	MLG1005S0N7BT000
0.7	± 0.2 nH	—	100	10.0	18.7	0.10	0.02	1000	MLG1005S0N7CT000
0.8	± 0.1 nH	—	100	10.0	16.4	0.10	0.02	1000	MLG1005S0N8BT000
0.8	± 0.2 nH	—	100	10.0	16.4	0.10	0.02	1000	MLG1005S0N8CT000
0.9	± 0.1 nH	—	100	10.0	17.7	0.10	0.04	1000	MLG1005S0N9BT000
0.9	± 0.2 nH	—	100	10.0	17.7	0.10	0.04	1000	MLG1005S0N9CT000
1.0	± 0.1 nH	7	100	10.0	13.8	0.10	0.04	1000	MLG1005S1N0BT000
1.0	± 0.2 nH	7	100	10.0	13.8	0.10	0.04	1000	MLG1005S1N0CT000
1.0	± 0.3 nH	7	100	10.0	13.8	0.10	0.04	1000	MLG1005S1N0ST000
1.1	± 0.1 nH	7	100	10.0	19.3	0.10	0.03	1000	MLG1005S1N1BT000
1.1	± 0.2 nH	7	100	10.0	19.3	0.10	0.03	1000	MLG1005S1N1CT000
1.1	± 0.3 nH	7	100	10.0	19.3	0.10	0.03	1000	MLG1005S1N1ST000
1.2	± 0.1 nH	7	100	10.0	11.6	0.10	0.04	1000	MLG1005S1N2BT000
1.2	± 0.2 nH	7	100	10.0	11.6	0.10	0.04	1000	MLG1005S1N2CT000
1.2	± 0.3 nH	7	100	10.0	11.6	0.10	0.04	1000	MLG1005S1N2ST000
1.3	± 0.1 nH	7	100	8.0	11.7	0.10	0.04	1000	MLG1005S1N3BT000
1.3	± 0.2 nH	7	100	8.0	11.7	0.10	0.04	1000	MLG1005S1N3CT000
1.3	± 0.3 nH	7	100	8.0	11.7	0.10	0.04	1000	MLG1005S1N3ST000
1.5	± 0.1 nH	7	100	8.0	9.6	0.10	0.06	1000	MLG1005S1N5BT000
1.5	± 0.2 nH	7	100	8.0	9.6	0.10	0.06	1000	MLG1005S1N5CT000
1.5	± 0.3 nH	7	100	8.0	9.6	0.10	0.06	1000	MLG1005S1N5ST000
1.6	± 0.1 nH	7	100	7.5	9.4	0.12	0.05	1000	MLG1005S1N6BT000
1.6	± 0.2 nH	7	100	7.5	9.4	0.12	0.05	1000	MLG1005S1N6CT000
1.6	± 0.3 nH	7	100	7.5	9.4	0.12	0.05	1000	MLG1005S1N6ST000
1.8	± 0.1 nH	7	100	8.0	10.3	0.15	0.06	900	MLG1005S1N8BT000
1.8	± 0.2 nH	7	100	8.0	10.3	0.15	0.06	900	MLG1005S1N8CT000
1.8	± 0.3 nH	7	100	8.0	10.3	0.15	0.06	900	MLG1005S1N8ST000
2.0	± 0.1 nH	7	100	7.5	9.3	0.15	0.07	900	MLG1005S2N0BT000
2.0	± 0.2 nH	7	100	7.5	9.3	0.15	0.07	900	MLG1005S2N0CT000
2.0	± 0.3 nH	7	100	7.5	9.3	0.15	0.07	900	MLG1005S2N0ST000
2.2	± 0.1 nH	7	100	7.0	8.6	0.15	0.08	900	MLG1005S2N2BT000
2.2	± 0.2 nH	7	100	7.0	8.6	0.15	0.08	900	MLG1005S2N2CT000
2.2	± 0.3 nH	7	100	7.0	8.6	0.15	0.08	900	MLG1005S2N2ST000
2.4	± 0.1 nH	7	100	7.0	8.2	0.15	0.08	800	MLG1005S2N4BT000
2.4	± 0.2 nH	7	100	7.0	8.2	0.15	0.08	800	MLG1005S2N4CT000
2.4	± 0.3 nH	7	100	7.0	8.2	0.15	0.08	800	MLG1005S2N4ST000
2.7	± 0.1 nH	7	100	6.0	7.3	0.15	0.08	800	MLG1005S2N7BT000
2.7	± 0.2 nH	7	100	6.0	7.3	0.15	0.08	800	MLG1005S2N7CT000
2.7	± 0.3 nH	7	100	6.0	7.3	0.15	0.08	800	MLG1005S2N7ST000

* Please contact us for information on inductance tolerance, G ($\pm 2\%$).

Measurement equipment

Measurement item	Product No.	Manufacturer
L, Q	4291B +16193A	Keysight Technologies
Self-resonant frequency	8720C	Keysight Technologies
DC resistance	Type-7561	Yokogawa

* Equivalent measurement equipment may be used.

MLG1005S type

CHARACTERISTICS SPECIFICATION TABLE

L (nH)	Q Tolerance	Q min.	L, Q measuring frequency (MHz)	Self-resonant frequency		DC resistance		Rated current (mA)max.	Part No.*
				(GHz)min.	(GHz)typ.	(Ω)max.	(Ω)typ.		
3.0	± 0.1 nH	7	100	5.5	6.8	0.2	0.09	800	MLG1005S3N0BT000
3.0	± 0.2 nH	7	100	5.5	6.8	0.20	0.09	800	MLG1005S3N0CT000
3.0	± 0.3 nH	7	100	5.5	6.8	0.20	0.09	800	MLG1005S3N0ST000
3.3	± 0.1 nH	8	100	5.0	6.1	0.20	0.09	800	MLG1005S3N3BT000
3.3	± 0.2 nH	8	100	5.0	6.1	0.20	0.09	800	MLG1005S3N3CT000
3.3	± 0.3 nH	8	100	5.0	6.1	0.20	0.09	800	MLG1005S3N3ST000
3.6	± 0.1 nH	8	100	5.0	6.7	0.20	0.09	700	MLG1005S3N6BT000
3.6	± 0.2 nH	8	100	5.0	6.7	0.20	0.09	700	MLG1005S3N6CT000
3.6	± 0.3 nH	8	100	5.0	6.7	0.20	0.09	700	MLG1005S3N6ST000
3.9	± 0.1 nH	8	100	5.0	6.5	0.20	0.11	700	MLG1005S3N9BT000
3.9	± 0.2 nH	8	100	5.0	6.5	0.20	0.11	700	MLG1005S3N9CT000
3.9	± 0.3 nH	8	100	5.0	6.5	0.20	0.11	700	MLG1005S3N9ST000
4.3	± 0.2 nH	8	100	4.5	6.0	0.20	0.11	700	MLG1005S4N3CT000
4.3	± 0.3 nH	8	100	4.5	6.0	0.20	0.11	700	MLG1005S4N3ST000
4.7	± 0.2 nH	8	100	4.5	5.4	0.25	0.12	700	MLG1005S4N7CT000
4.7	± 0.3 nH	8	100	4.5	5.4	0.25	0.12	700	MLG1005S4N7ST000
5.1	± 0.2 nH	8	100	4.0	5.0	0.25	0.13	600	MLG1005S5N1CT000
5.1	± 0.3 nH	8	100	4.0	5.0	0.25	0.13	600	MLG1005S5N1ST000
5.6	± 0.2 nH	8	100	4.0	5.3	0.25	0.14	600	MLG1005S5N6CT000
5.6	± 0.3 nH	8	100	4.0	5.3	0.25	0.14	600	MLG1005S5N6ST000
6.2	± 0.3 nH	8	100	4.0	4.7	0.25	0.16	600	MLG1005S6N2ST000
6.2	$\pm 3\%$	8	100	4.0	4.7	0.25	0.16	600	MLG1005S6N2HT000
6.8	$\pm 3\%$	8	100	3.5	4.4	0.25	0.15	600	MLG1005S6N8HT000
6.8	$\pm 5\%$	8	100	3.5	4.4	0.25	0.15	600	MLG1005S6N8JT000
7.5	$\pm 3\%$	8	100	3.0	4.1	0.25	0.15	500	MLG1005S7N5HT000
7.5	$\pm 5\%$	8	100	3.0	4.1	0.25	0.15	500	MLG1005S7N5JT000
8.2	$\pm 3\%$	8	100	3.0	4.0	0.30	0.19	500	MLG1005S8N2HT000
8.2	$\pm 5\%$	8	100	3.0	4.0	0.30	0.19	500	MLG1005S8N2JT000
9.1	$\pm 3\%$	8	100	3.0	3.8	0.30	0.20	500	MLG1005S9N1HT000
9.1	$\pm 5\%$	8	100	3.0	3.8	0.30	0.20	500	MLG1005S9N1JT000
10	$\pm 3\%$	8	100	2.5	3.4	0.35	0.22	500	MLG1005S10NJT000
10	$\pm 5\%$	8	100	2.5	3.4	0.35	0.22	500	MLG1005S10NJT000
11	$\pm 3\%$	8	100	2.5	3.5	0.40	0.28	400	MLG1005S11NHT000
11	$\pm 5\%$	8	100	2.5	3.5	0.40	0.28	400	MLG1005S11NJT000
12	$\pm 3\%$	8	100	2.5	3.0	0.40	0.25	400	MLG1005S12NHT000
12	$\pm 5\%$	8	100	2.5	3.0	0.40	0.25	400	MLG1005S12NJT000
13	$\pm 3\%$	8	100	2.4	2.9	0.50	0.26	400	MLG1005S13NHT000
13	$\pm 5\%$	8	100	2.4	2.9	0.50	0.26	400	MLG1005S13NJT000
15	$\pm 3\%$	8	100	2.2	2.8	0.55	0.35	400	MLG1005S15NHT000
15	$\pm 5\%$	8	100	2.2	2.8	0.55	0.35	400	MLG1005S15NJT000
16	$\pm 3\%$	8	100	2.1	2.7	0.55	0.32	400	MLG1005S16NHT000
16	$\pm 5\%$	8	100	2.1	2.7	0.55	0.32	400	MLG1005S16NJT000
18	$\pm 3\%$	8	100	2.0	2.5	0.60	0.40	350	MLG1005S18NHT000
18	$\pm 5\%$	8	100	2.0	2.5	0.60	0.40	350	MLG1005S18NJT000
20	$\pm 3\%$	8	100	1.9	2.4	0.60	0.38	350	MLG1005S20NHT000
20	$\pm 5\%$	8	100	1.9	2.4	0.60	0.38	350	MLG1005S20NJT000
22	$\pm 3\%$	8	100	1.7	2.2	0.70	0.46	350	MLG1005S22NHT000
22	$\pm 5\%$	8	100	1.7	2.2	0.70	0.46	350	MLG1005S22NJT000

* Please contact us for information on inductance tolerance, G ($\pm 2\%$).

Measurement equipment

Measurement item	Product No.	Manufacturer
L, Q	4291B +16193A	Keysight Technologies
Self-resonant frequency	8720C	Keysight Technologies
DC resistance	Type-7561	Yokogawa

* Equivalent measurement equipment may be used.

MLG1005S type

CHARACTERISTICS SPECIFICATION TABLE

L (nH)	Q Tolerance	Q min.	L, Q measuring frequency (MHz)	Self-resonant frequency		DC resistance		Rated current (mA)max.	Part No.*
				(GHz)min.	(GHz)typ.	(Ω)max.	(Ω)typ.		
24	$\pm 3\%$	8	100	1.7	2.1	0.70	0.43	350	MLG1005S24NHT000
24	$\pm 5\%$	8	100	1.7	2.1	0.70	0.43	350	MLG1005S24NJT000
27	$\pm 3\%$	8	100	1.6	2.0	0.80	0.53	300	MLG1005S27NHT000
27	$\pm 5\%$	8	100	1.6	2.0	0.80	0.53	300	MLG1005S27NJT000
30	$\pm 3\%$	8	100	1.5	1.9	0.80	0.50	300	MLG1005S30NHT000
30	$\pm 5\%$	8	100	1.5	1.9	0.80	0.50	300	MLG1005S30NJT000
33	$\pm 3\%$	8	100	1.4	1.8	0.90	0.59	300	MLG1005S33NHT000
33	$\pm 5\%$	8	100	1.4	1.8	0.90	0.59	300	MLG1005S33NJT000
36	$\pm 3\%$	8	100	1.3	1.7	1.00	0.62	250	MLG1005S36NHT000
36	$\pm 5\%$	8	100	1.3	1.7	1.00	0.62	250	MLG1005S36NJT000
39	$\pm 3\%$	8	100	1.2	1.6	1.00	0.65	250	MLG1005S39NHT000
39	$\pm 5\%$	8	100	1.2	1.6	1.00	0.65	250	MLG1005S39NJT000
43	$\pm 3\%$	8	100	1.2	1.6	1.10	0.67	250	MLG1005S43NHT000
43	$\pm 5\%$	8	100	1.2	1.6	1.10	0.67	250	MLG1005S43NJT000
47	$\pm 3\%$	8	100	1.1	1.4	1.20	0.75	250	MLG1005S47NHT000
47	$\pm 5\%$	8	100	1.1	1.4	1.20	0.75	250	MLG1005S47NJT000
51	$\pm 3\%$	8	100	1.1	1.5	1.20	0.72	250	MLG1005S51NHT000
51	$\pm 5\%$	8	100	1.1	1.5	1.20	0.72	250	MLG1005S51NJT000
56	$\pm 3\%$	8	100	1.0	1.3	1.30	0.83	200	MLG1005S56NHT000
56	$\pm 5\%$	8	100	1.0	1.3	1.30	0.83	200	MLG1005S56NJT000
62	$\pm 3\%$	8	100	1.0	1.3	1.40	0.85	200	MLG1005S62NHT000
62	$\pm 5\%$	8	100	1.0	1.3	1.40	0.85	200	MLG1005S62NJT000
68	$\pm 3\%$	8	100	0.8	1.1	1.50	0.87	200	MLG1005S68NHT000
68	$\pm 5\%$	8	100	0.8	1.1	1.50	0.87	200	MLG1005S68NJT000
75	$\pm 3\%$	8	100	0.75	1.1	1.50	0.93	200	MLG1005S75NHT000
75	$\pm 5\%$	8	100	0.75	1.1	1.50	0.93	200	MLG1005S75NJT000
82	$\pm 3\%$	8	100	0.7	1.0	1.60	1.01	200	MLG1005S82NHT000
82	$\pm 5\%$	8	100	0.7	1.0	1.60	1.01	200	MLG1005S82NJT000
91	$\pm 3\%$	8	100	0.7	0.9	1.80	1.14	200	MLG1005S91NHT000
91	$\pm 5\%$	8	100	0.7	0.9	1.80	1.14	200	MLG1005S91NJT000
100	$\pm 3\%$	8	100	0.7	0.9	2.00	1.37	200	MLG1005SR10HT000
100	$\pm 5\%$	8	100	0.7	0.9	2.00	1.37	200	MLG1005SR10JT000
110	$\pm 3\%$	8	100	0.7	0.9	2.20	1.48	150	MLG1005SR11HT000
110	$\pm 5\%$	8	100	0.7	0.9	2.20	1.48	150	MLG1005SR11JT000
120	$\pm 3\%$	8	100	0.6	0.8	2.20	1.48	150	MLG1005SR12HT000
120	$\pm 5\%$	8	100	0.6	0.8	2.20	1.48	150	MLG1005SR12JT000
130	$\pm 3\%$	8	100	0.6	0.8	2.50	1.68	150	MLG1005SR13HT000
130	$\pm 5\%$	8	100	0.6	0.8	2.50	1.68	150	MLG1005SR13JT000
150	$\pm 3\%$	8	100	0.55	0.7	3.50	2.44	150	MLG1005SR15HT000
150	$\pm 5\%$	8	100	0.55	0.7	3.50	2.44	150	MLG1005SR15JT000
160	$\pm 3\%$	8	100	0.5	0.6	3.80	2.74	150	MLG1005SR16HT000
160	$\pm 5\%$	8	100	0.5	0.6	3.80	2.74	150	MLG1005SR16JT000
180	$\pm 3\%$	8	100	0.5	0.6	3.80	2.88	150	MLG1005SR18HT000
180	$\pm 5\%$	8	100	0.5	0.6	3.80	2.88	150	MLG1005SR18JT000
200	$\pm 3\%$	8	100	0.42	0.5	4.20	3.15	100	MLG1005SR20HT000
200	$\pm 5\%$	8	100	0.42	0.5	4.20	3.15	100	MLG1005SR20JT000
220	$\pm 3\%$	8	100	0.45	0.5	4.20	3.02	100	MLG1005SR22HT000
220	$\pm 5\%$	8	100	0.45	0.5	4.20	3.02	100	MLG1005SR22JT000

* Please contact us for information on inductance tolerance, G ($\pm 2\%$).

Measurement equipment

Measurement item	Product No.	Manufacturer
L, Q	4291B +16193A	Keysight Technologies
Self-resonant frequency	8720C	Keysight Technologies
DC resistance	Type-7561	Yokogawa

* Equivalent measurement equipment may be used.

MLG1005S type

CHARACTERISTICS SPECIFICATION TABLE

L (nH)	Tolerance	Q min.	L, Q measuring frequency (MHz)	Self-resonant frequency		DC resistance		Rated current (mA)max.	Part No.*
				(GHz)min.	(GHz)typ.	(Ω)max.	(Ω)typ.		
240	$\pm 3\%$	8	100	0.4	0.5	4.8	3.42	100	MLG1005SR24HT000
240	$\pm 5\%$	8	100	0.4	0.5	4.80	3.42	100	MLG1005SR24JT000
270	$\pm 3\%$	8	100	0.4	0.5	4.80	3.54	100	MLG1005SR27HT000
270	$\pm 5\%$	8	100	0.4	0.5	4.80	3.54	100	MLG1005SR27JT000
300	$\pm 3\%$	6	50	0.35	0.4	6.50	4.82	50	MLG1005SR30HT000
300	$\pm 5\%$	6	50	0.35	0.4	6.50	4.82	50	MLG1005SR30JT000
330	$\pm 3\%$	6	50	0.35	0.4	7.00	5.21	50	MLG1005SR33HT000
330	$\pm 5\%$	6	50	0.35	0.4	7.00	5.21	50	MLG1005SR33JT000
360	$\pm 3\%$	6	50	0.3	0.4	7.50	5.39	50	MLG1005SR36HT000
360	$\pm 5\%$	6	50	0.3	0.4	7.50	5.39	50	MLG1005SR36JT000
390	$\pm 3\%$	6	50	0.3	0.4	8.00	5.97	50	MLG1005SR39HT000
390	$\pm 5\%$	6	50	0.3	0.4	8.00	5.97	50	MLG1005SR39JT000

* Please contact us for information on inductance tolerance, G ($\pm 2\%$).

Measurement equipment

Measurement item	Product No.	Manufacturer
L, Q	4291B +16193A	Keysight Technologies
Self-resonant frequency	8720C	Keysight Technologies
DC resistance	Type-7561	Yokogawa

* Equivalent measurement equipment may be used.

MLG1005S type

L, Q FREQUENCY CHARACTERISTICS TABLE

L(nH)typ.					Q typ.					Part No.*
500MHz	800MHz	1.8GHz	2.0GHz	2.4GHz	500MHz	800MHz	1.8GHz	2.0GHz	2.4GHz	
0.3	0.3	0.3	0.3	0.3	22min.	27min.	46min.	49min.	53min.	MLG1005S0N3BT000
0.3	0.3	0.3	0.3	0.3	22min.	27min.	46min.	49min.	53min.	MLG1005S0N3CT000
0.4	0.4	0.4	0.4	0.4	22min.	27min.	46min.	49min.	53min.	MLG1005S0N4BT000
0.4	0.4	0.4	0.4	0.4	22min.	27min.	46min.	49min.	53min.	MLG1005S0N4CT000
0.5	0.5	0.5	0.5	0.5	22min.	27min.	46min.	49min.	53min.	MLG1005S0N5BT000
0.5	0.5	0.5	0.5	0.5	22min.	27min.	46min.	49min.	53min.	MLG1005S0N5CT000
0.6	0.6	0.6	0.6	0.6	22	27	46	49	53	MLG1005S0N6BT000
0.6	0.6	0.6	0.6	0.6	22	27	46	49	53	MLG1005S0N6CT000
0.7	0.7	0.7	0.7	0.7	22	28	45	49	54	MLG1005S0N7BT000
0.7	0.7	0.7	0.7	0.7	22	28	45	49	54	MLG1005S0N7CT000
0.8	0.8	0.8	0.8	0.8	26	34	57	60	66	MLG1005S0N8BT000
0.8	0.8	0.8	0.8	0.8	26	34	57	60	66	MLG1005S0N8CT000
0.9	0.8	0.8	0.8	0.8	21	27	44	47	53	MLG1005S0N9BT000
0.9	0.8	0.8	0.8	0.8	21	27	44	47	53	MLG1005S0N9CT000
0.9	0.9	0.9	0.9	0.9	22	29	48	50	56	MLG1005S1N0BT000
0.9	0.9	0.9	0.9	0.9	22	29	48	50	56	MLG1005S1N0CT000
0.9	0.9	0.9	0.9	0.9	22	29	48	50	56	MLG1005S1N0ST000
1.0	1.0	1.0	1.0	1.0	23	29	47	50	57	MLG1005S1N1BT000
1.0	1.0	1.0	1.0	1.0	23	29	47	50	57	MLG1005S1N1CT000
1.0	1.0	1.0	1.0	1.0	23	29	47	50	57	MLG1005S1N1ST000
1.1	1.1	1.1	1.1	1.1	23	29	48	50	56	MLG1005S1N2BT000
1.1	1.1	1.1	1.1	1.1	23	29	48	50	56	MLG1005S1N2CT000
1.1	1.1	1.1	1.1	1.1	23	29	48	50	56	MLG1005S1N2ST000
1.2	1.2	1.2	1.2	1.2	22	27	44	47	53	MLG1005S1N3BT000
1.2	1.2	1.2	1.2	1.2	22	27	44	47	53	MLG1005S1N3CT000
1.2	1.2	1.2	1.2	1.2	22	27	44	47	53	MLG1005S1N3ST000
1.4	1.4	1.4	1.5	1.5	23	29	47	50	56	MLG1005S1N5BT000
1.4	1.4	1.4	1.5	1.5	23	29	47	50	56	MLG1005S1N5CT000
1.4	1.4	1.4	1.5	1.5	23	29	47	50	56	MLG1005S1N5ST000
1.5	1.5	1.5	1.6	1.6	23	29	46	49	54	MLG1005S1N6BT000
1.5	1.5	1.5	1.6	1.6	23	29	46	49	54	MLG1005S1N6CT000
1.5	1.5	1.5	1.6	1.6	23	29	46	49	54	MLG1005S1N6ST000
1.7	1.7	1.7	1.7	1.7	20	26	41	43	49	MLG1005S1N8BT000
1.7	1.7	1.7	1.7	1.7	20	26	41	43	49	MLG1005S1N8CT000
1.7	1.7	1.7	1.7	1.7	20	26	41	43	49	MLG1005S1N8ST000
1.9	1.9	1.9	1.9	1.9	21	25	41	43	48	MLG1005S2N0BT000
1.9	1.9	1.9	1.9	1.9	21	25	41	43	48	MLG1005S2N0CT000
1.9	1.9	1.9	1.9	1.9	21	25	41	43	48	MLG1005S2N0ST000
2.1	2.1	2.1	2.1	2.2	22	27	44	47	52	MLG1005S2N2BT000
2.1	2.1	2.1	2.1	2.2	22	27	44	47	52	MLG1005S2N2CT000
2.1	2.1	2.1	2.1	2.2	22	27	44	47	52	MLG1005S2N2ST000
2.3	2.3	2.3	2.3	2.4	21	26	42	44	49	MLG1005S2N4BT000
2.3	2.3	2.3	2.3	2.4	21	26	42	44	49	MLG1005S2N4CT000
2.3	2.3	2.3	2.3	2.4	21	26	42	44	49	MLG1005S2N4ST000
2.6	2.6	2.6	2.7	2.7	22	27	43	45	50	MLG1005S2N7BT000
2.6	2.6	2.6	2.7	2.7	22	27	43	45	50	MLG1005S2N7CT000
2.6	2.6	2.6	2.7	2.7	22	27	43	45	50	MLG1005S2N7ST000
2.9	2.9	3.0	3.0	3.1	24	29	47	49	54	MLG1005S3N0BT000
2.9	2.9	3.0	3.0	3.1	24	29	47	49	54	MLG1005S3N0CT000
2.9	2.9	3.0	3.0	3.1	24	29	47	49	54	MLG1005S3N0ST000

* Please contact us for information on inductance tolerance, G ($\pm 2\%$).

Measurement equipment

Product No.	Manufacturer
4291B +16193A	Keysight Technologies

* Equivalent measurement equipment may be used.

MLG1005S type

L, Q FREQUENCY CHARACTERISTICS TABLE

L(nH)typ.					Q typ.					Part No.*
500MHz	800MHz	1.8GHz	2.0GHz	2.4GHz	500MHz	800MHz	1.8GHz	2.0GHz	2.4GHz	
3.2	3.2	3.3	3.4	3.5	24	30	46	48	53	MLG1005S3N3BT000
3.2	3.2	3.3	3.4	3.5	24	30	46	48	53	MLG1005S3N3CT000
3.2	3.2	3.3	3.4	3.5	24	30	46	48	53	MLG1005S3N3ST000
3.4	3.4	3.6	3.6	3.8	21	26	40	42	46	MLG1005S3N6BT000
3.4	3.4	3.6	3.6	3.8	21	26	40	42	46	MLG1005S3N6CT000
3.4	3.4	3.6	3.6	3.8	21	26	40	42	46	MLG1005S3N6ST000
3.7	3.7	3.9	3.9	4.1	22	28	43	45	50	MLG1005S3N9BT000
3.7	3.7	3.9	3.9	4.1	22	28	43	45	50	MLG1005S3N9CT000
3.7	3.7	3.9	3.9	4.1	22	28	43	45	50	MLG1005S3N9ST000
4.1	4.1	4.3	4.4	4.6	24	30	47	49	53	MLG1005S4N3CT000
4.1	4.1	4.3	4.4	4.6	24	30	47	49	53	MLG1005S4N3ST000
4.5	4.5	4.8	4.9	5.2	23	30	45	47	50	MLG1005S4N7CT000
4.5	4.5	4.8	4.9	5.2	23	30	45	47	50	MLG1005S4N7ST000
4.9	4.9	5.4	5.6	6.1	23	29	42	43	44	MLG1005S5N1CT000
4.9	4.9	5.4	5.6	6.1	23	29	42	43	44	MLG1005S5N1ST000
5.4	5.4	5.8	5.9	6.3	22	28	42	43	45	MLG1005S5N6CT000
5.4	5.4	5.8	5.9	6.3	22	28	42	43	45	MLG1005S5N6ST000
6.0	6.0	6.8	7.1	7.8	24	29	42	43	43	MLG1005S6N2HT000
6.0	6.0	6.8	7.1	7.8	24	29	42	43	43	MLG1005S6N2ST000
6.5	6.6	7.4	7.8	8.6	23	28	40	41	41	MLG1005S6N8HT000
6.5	6.6	7.4	7.8	8.6	23	28	40	41	41	MLG1005S6N8JT000
7.2	7.4	8.6	9.2	10.5	24	30	41	41	39	MLG1005S7N5HT000
7.2	7.4	8.6	9.2	10.5	24	30	41	41	39	MLG1005S7N5JT000
7.9	8.0	9.3	9.9	11.3	23	28	38	38	36	MLG1005S8N2HT000
7.9	8.0	9.3	9.9	11.3	23	28	38	38	36	MLG1005S8N2JT000
8.8	9.0	10.8	11.6	13.7	24	30	40	39	36	MLG1005S9N1HT000
8.8	9.0	10.8	11.6	13.7	24	30	40	39	36	MLG1005S9N1JT000
9.7	9.9	12.4	13.5	16.7	24	30	37	36	31	MLG1005S10NHT000
9.7	9.9	12.4	13.5	16.7	24	30	37	36	31	MLG1005S10NJT000
10.6	10.9	13.8	15.1	19.0	23	28	34	33	28	MLG1005S11NHT000
10.6	10.9	13.8	15.1	19.0	23	28	34	33	28	MLG1005S11NJT000
11.7	12.1	16.2	18.3		23	29	33	31		MLG1005S12NHT000
11.7	12.1	16.2	18.3		23	29	33	31		MLG1005S12NJT000
12.6	13.0	18.3	21.3		20	24	25	22		MLG1005S13NHT000
12.6	13	18.3	21.3		20	24	25	22		MLG1005S13NJT000
14.7	15.3	22.0	26.0		23	28	29	26		MLG1005S15NHT000
14.7	15.3	22.0	26.0		23	28	29	26		MLG1005S15NJT000
15.6	16.2	24.1	29.0		22	26	26	22		MLG1005S16NHT000
15.6	16.2	24.1	29.0		22	26	26	22		MLG1005S16NJT000
17.7	18.6	29.0			23	28	26			MLG1005S18NHT000
17.7	18.6	29.0			23	28	26			MLG1005S18NJT000
19.7	20.8	36.8			21	25	21			MLG1005S20NHT000
19.7	20.8	36.8			21	25	21			MLG1005S20NJT000
21.8	23.3				22	27				MLG1005S22NHT000
21.8	23.3				22	27				MLG1005S22NJT000
23.8	25.5				22	26				MLG1005S24NHT000
23.8	25.5				22	26				MLG1005S24NJT000
27.0	29.6				20	23				MLG1005S27NHT000
27.0	29.6				20	23				MLG1005S27NJT000

* Please contact us for information on inductance tolerance, G ($\pm 2\%$).

Measurement equipment

Product No.	Manufacturer
4291B +16193A	Keysight Technologies

* Equivalent measurement equipment may be used.

MLG1005S type

■ L, Q FREQUENCY CHARACTERISTICS TABLE

L(nH)typ.					Q typ.					Part No.*
500MHz	800MHz	1.8GHz	2.0GHz	2.4GHz	500MHz	800MHz	1.8GHz	2.0GHz	2.4GHz	
30.1	33.5				19	21				MLG1005S30NHT000
30.1	33.5				19	21				MLG1005S30NJT000
33.5	37.8				20	23				MLG1005S33NHT000
33.5	37.8				20	23				MLG1005S33NJT000
36.7	41.5				21	23				MLG1005S36NHT000
36.7	41.5				21	23				MLG1005S36NJT000
40.3	46.9				20	21				MLG1005S39NHT000
40.3	46.9				20	21				MLG1005S39NJT000
44.3	51.6				20	21				MLG1005S43NHT000
44.3	51.6				20	21				MLG1005S43NJT000
50.2	63.2				19	20				MLG1005S47NHT000
50.2	63.2				19	20				MLG1005S47NJT000
53.7	65.6				19	19				MLG1005S51NHT000
53.7	65.6				19	19				MLG1005S51NJT000
60.9	80.2				19	18				MLG1005S56NHT000
60.9	80.2				19	18				MLG1005S56NJT000
67.5	89.8				18	16				MLG1005S62NHT000
67.5	89.8				18	16				MLG1005S62NJT000
75.8	107.5				17	15				MLG1005S68NHT000
75.8	107.5				17	15				MLG1005S68NJT000
86.5	135.2				17	13				MLG1005S75NHT000
86.5	135.2				17	13				MLG1005S75NJT000
96.9					16					MLG1005S82NHT000
96.9					16					MLG1005S82NJT000
111.0					15					MLG1005S91NHT000
111.0					15					MLG1005S91NJT000
128.9					14					MLG1005SR10HT000
128.9					14					MLG1005SR10JT000
140.8					15					MLG1005SR11HT000
140.8					15					MLG1005SR11JT000
175.2					12					MLG1005SR12HT000
175.2					12					MLG1005SR12JT000
187.8					13					MLG1005SR13HT000
187.8					13					MLG1005SR13JT000
284.7					11					MLG1005SR15HT000
284.7					11					MLG1005SR15JT000
										MLG1005SR16HT000
										MLG1005SR16JT000
										MLG1005SR18HT000
										MLG1005SR18JT000
										MLG1005SR20HT000
										MLG1005SR20JT000
										MLG1005SR22HT000
										MLG1005SR22JT000
										MLG1005SR24HT000
										MLG1005SR24JT000
										MLG1005SR27HT000
										MLG1005SR27JT000
										MLG1005SR30HT000
										MLG1005SR30JT000

* Please contact us for information on inductance tolerance, G ($\pm 2\%$).

Measurement equipment

Product No.	Manufacturer
4291B +16193A	Keysight Technologies

* Equivalent measurement equipment may be used.

MLG1005S type

L, Q FREQUENCY CHARACTERISTICS TABLE

L(nH)typ.					Q typ.					Part No.*
500MHz	800MHz	1.8GHz	2.0GHz	2.4GHz	500MHz	800MHz	1.8GHz	2.0GHz	2.4GHz	
										MLG1005SR33HT000
										MLG1005SR33JT000
										MLG1005SR36HT000
										MLG1005SR36JT000
										MLG1005SR39HT000
										MLG1005SR39JT000

* Please contact us for information on inductance tolerance, G ($\pm 2\%$).

Measurement equipment

Product No.	Manufacturer
4291B +16193A	Keysight Technologies

* Equivalent measurement equipment may be used.

MLG1005S type

L FREQUENCY CHARACTERISTICS (EXAMPLE)

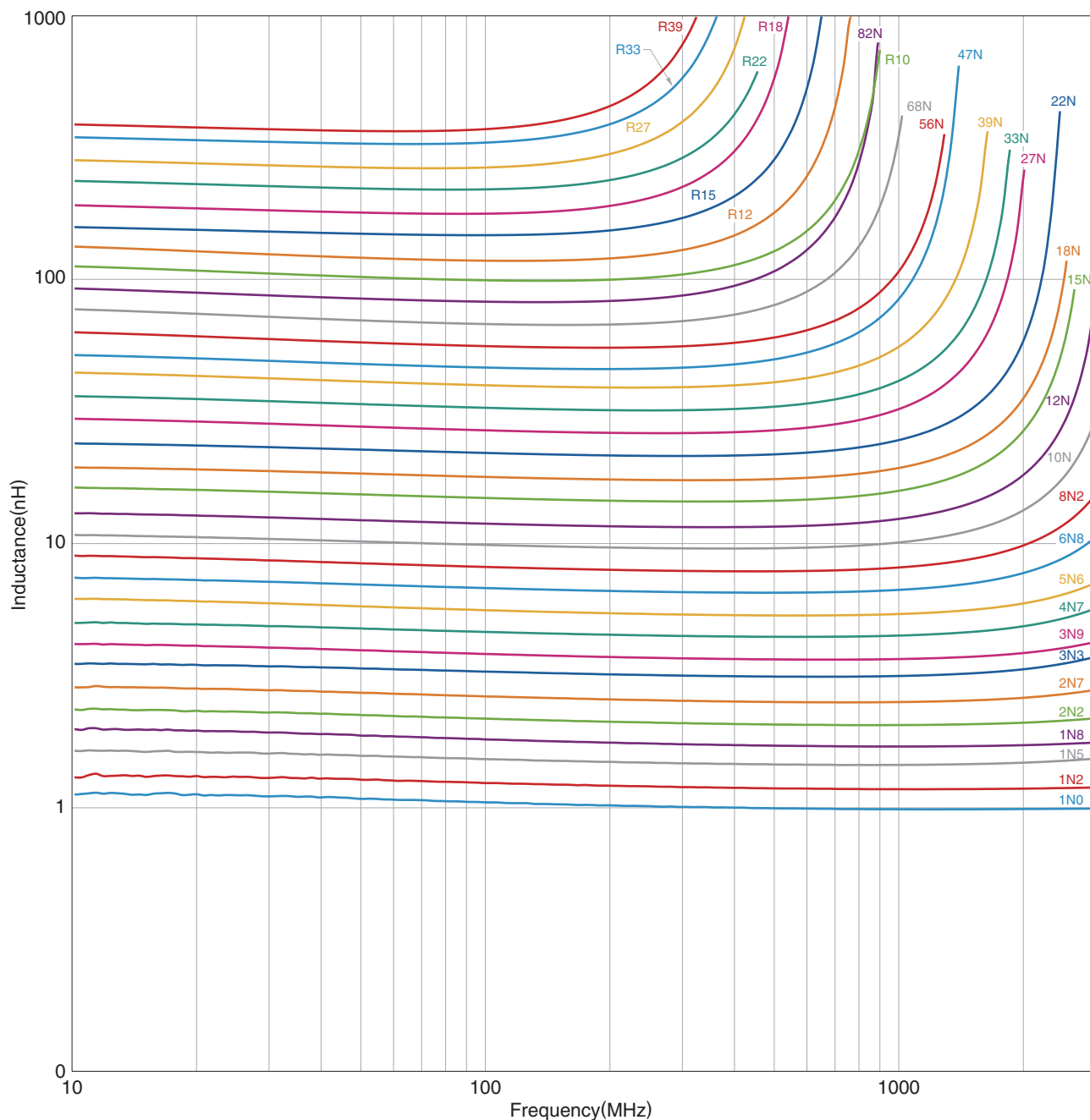

Measurement equipment

Product No.	Manufacturer
E4991A +16193A	Keysight Technologies

* Equivalent measurement equipment may be used.

MLG1005S type

Q FREQUENCY CHARACTERISTICS (EXAMPLE)

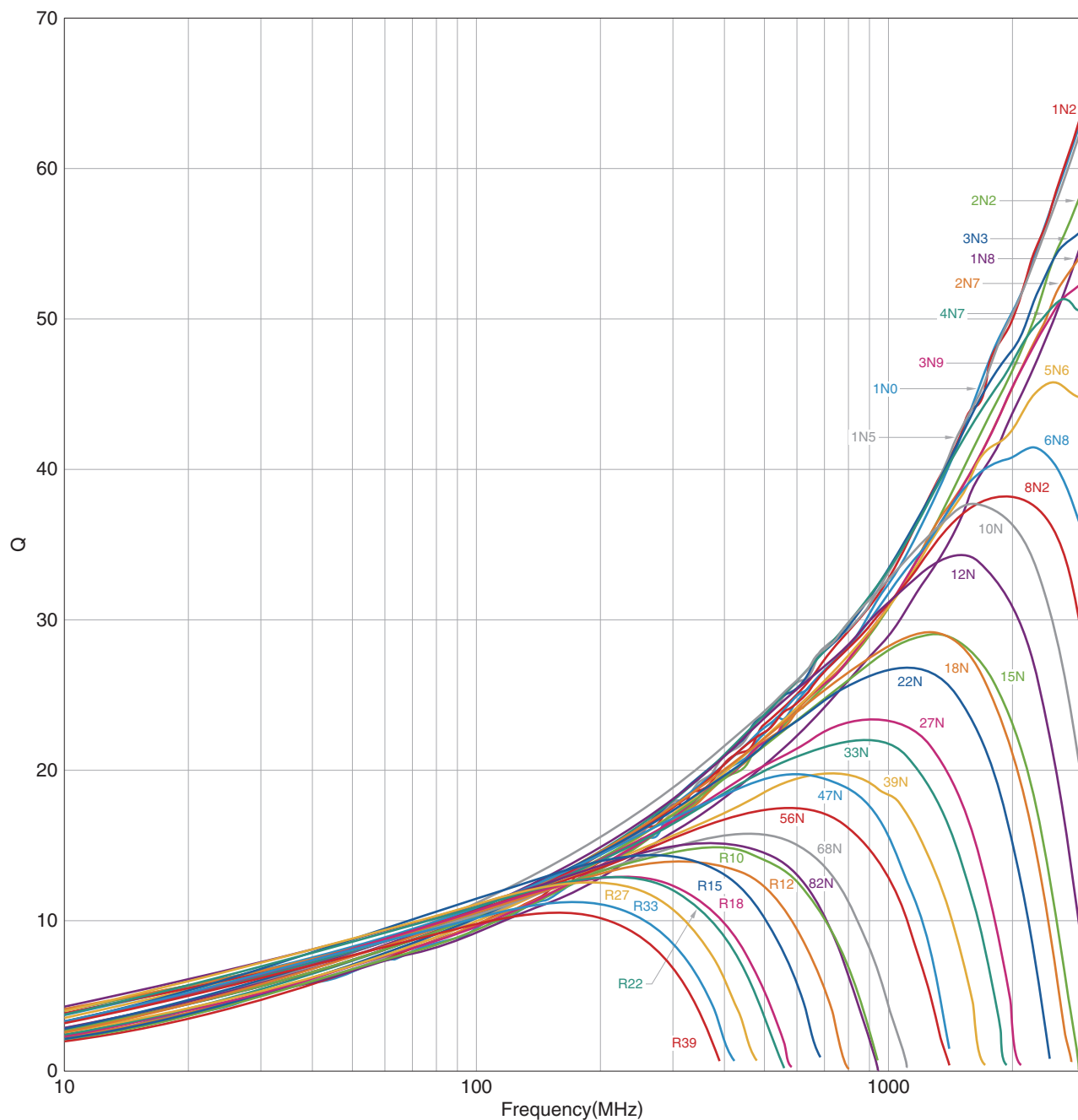

Measurement equipment

Product No.	Manufacturer
E4991A +16193A	Keysight Technologies

* Equivalent measurement equipment may be used.

MLG1005S type

SHAPE & DIMENSIONS

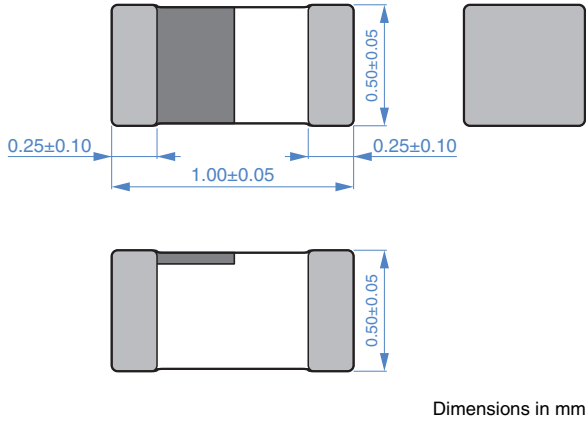

PACKAGING STYLE

REEL DIMENSIONS

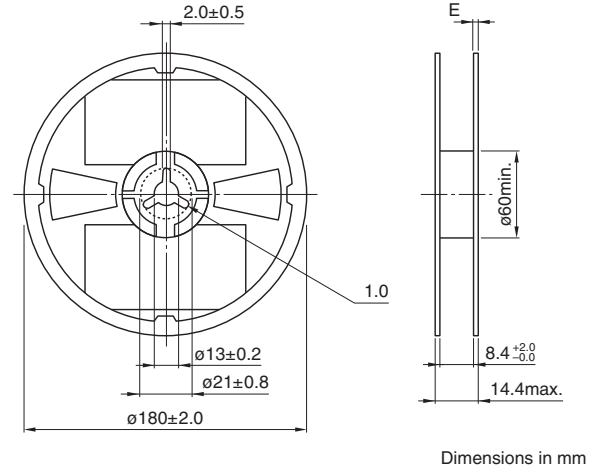

RECOMMENDED LAND PATTERN

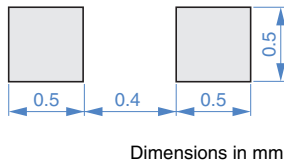

TAPE DIMENSIONS

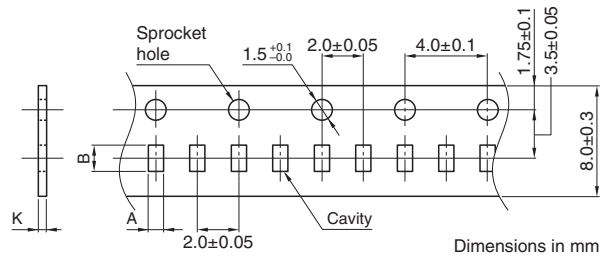

RECOMMENDED REFLOW PROFILE

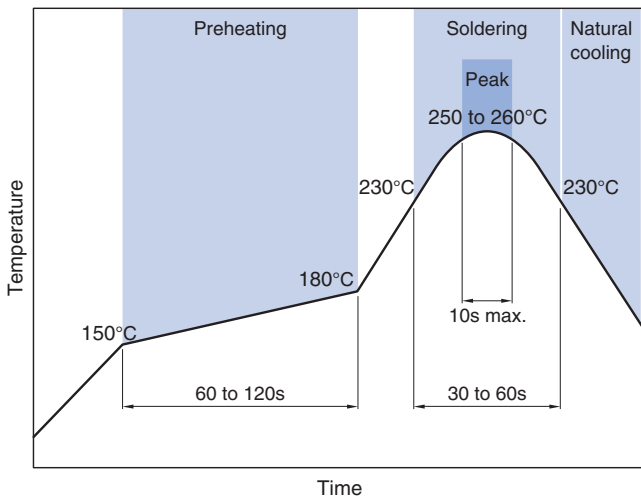

Type	A	B	K
MLG1005S	0.62±0.1	1.12±0.1	0.8 max.

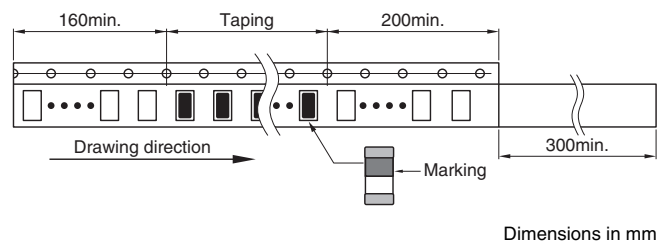

PACKAGE QUANTITY

Package quantity	10000pcs/reel
------------------	---------------

TEMPERATURE RANGE, INDIVIDUAL WEIGHT

Operating temperature range	Storage temperature range*	Individual weight
-55 to +125 °C	-55 to +125 °C	1 mg

* The storage temperature range is for after the assembly.

REMINDERS FOR USING THESE PRODUCTS

Before using these products, be sure to request the delivery specifications.

SAFETY REMINDERS

Please pay sufficient attention to the warnings for safe designing when using this products.

REMINDERS

- The storage period is within 12 months. Be sure to follow the storage conditions (temperature: 5 to 40°C, humidity: 10 to 75% RH or less).
If the storage period elapses, the soldering of the terminal electrodes may deteriorate.
- Do not use or store in locations where there are conditions such as gas corrosion (salt, acid, alkali, etc.).
- Before soldering, be sure to preheat components.
The preheating temperature should be set so that the temperature difference between the solder temperature and chip temperature does not exceed 150°C.
- Soldering corrections after mounting should be within the range of the conditions determined in the specifications.
If overheated, a short circuit, performance deterioration, or lifespan shortening may occur.
- When embedding a printed circuit board where a chip is mounted to a set, be sure that residual stress is not given to the chip due to the overall distortion of the printed circuit board and partial distortion such as at screw tightening portions.
- Self heating (temperature increase) occurs when the power is turned ON, so the tolerance should be sufficient for the set thermal design.
- Carefully lay out the coil for the circuit board design of the non-magnetic shield type.
A malfunction may occur due to magnetic interference.
- Use a wrist band to discharge static electricity in your body through the grounding wire.
- Do not expose the products to magnets or magnetic fields.
- Do not use for a purpose outside of the contents regulated in the delivery specifications.
- The products listed on this catalog are intended for use in general electronic equipment (AV equipment, telecommunications equipment, home appliances, amusement equipment, computer equipment, personal equipment, office equipment, measurement equipment, industrial robots) under a normal operation and use condition.
The products are not designed or warranted to meet the requirements of the applications listed below, whose performance and/or quality require a more stringent level of safety or reliability, or whose failure, malfunction or trouble could cause serious damage to society, person or property.
If you intend to use the products in the applications listed below or if you have special requirements exceeding the range or conditions set forth in the each catalog, please contact us.

- (1) Aerospace/aviation equipment
- (2) Transportation equipment (cars, electric trains, ships, etc.)
- (3) Medical equipment
- (4) Power-generation control equipment
- (5) Atomic energy-related equipment
- (6) Seabed equipment
- (7) Transportation control equipment

- (8) Public information-processing equipment
- (9) Military equipment
- (10) Electric heating apparatus, burning equipment
- (11) Disaster prevention/crime prevention equipment
- (12) Safety equipment
- (13) Other applications that are not considered general-purpose applications

When designing your equipment even for general-purpose applications, you are kindly requested to take into consideration securing protection circuit/device or providing backup circuits in your equipment.