

## FEATURES

- Filterless Class-D amplifier with spread-spectrum  $\Sigma$ - $\Delta$  modulation**
- 3 W into 3  $\Omega$  load and 1.4 W into 8  $\Omega$  load at 5.0 V supply with <1% total harmonic distortion (THD + N)**
- 93% efficiency at 5.0 V, 1.4 W into 8  $\Omega$  speaker**
- >100 dB signal-to-noise ratio (SNR)**
- High PSSR at 217 Hz: 80 dB**
- Flexible gain adjustment pin: 0 dB to 12 dB in 3 dB steps**
- Fixed input impedance: 80 k $\Omega$**
- User-selectable ultralow EMI emissions mode**
- Single-supply operation from 2.5 V to 5.5 V**
- 20 nA shutdown current**
- Short-circuit and thermal protection with autorecovery**
- Available in 9-ball, 1.5 mm  $\times$  1.5 mm WLCSP**
- Pop-and-click suppression**

## APPLICATIONS

- Mobile phones**
- MP3 players**
- Portable electronics**

## GENERAL DESCRIPTION

The SSM2375 is a fully integrated, high efficiency, Class-D audio amplifier. It is designed to maximize performance for mobile phone applications. The application circuit requires a minimum of external components and operates from a single 2.5 V to 5.5 V supply. It is capable of delivering 3 W of continuous output power with <1% THD + N driving a 3  $\Omega$  load from a 5.0 V supply.

The SSM2375 features a high efficiency, low noise modulation scheme that requires no external LC output filters. The modulation continues to provide high efficiency even at low output power. The SSM2375 operates with 93% efficiency at 1.4 W into 8  $\Omega$  or with 85% efficiency at 3 W into 3  $\Omega$  from a 5.0 V supply and has an SNR of >100 dB.

Spread-spectrum pulse density modulation (PDM) is used to provide lower EMI-radiated emissions compared with other Class-D architectures. The inherent randomized nature of spread-spectrum PDM eliminates the clock intermodulation (beating effect) of several amplifiers in close proximity.

The SSM2375 includes an optional modulation select pin (ultralow EMI emissions mode) that significantly reduces the radiated emissions at the Class-D outputs, particularly above 100 MHz. In ultralow EMI emissions mode, the SSM2375 can pass FCC Class B radiated emission testing with 50 cm, unshielded speaker cable without any external filtering.

The device also includes a highly flexible gain select pin that allows the user to select a gain of 0 dB, 3 dB, 6 dB, 9 dB, or 12 dB. The gain selection feature improves gain matching between multiple SSM2375 devices within a single application as compared to using external resistors to set the gain.

The SSM2375 has a micropower shutdown mode with a typical shutdown current of 20 nA. Shutdown is enabled by applying a logic low to the SD pin.

The device also includes pop-and-click suppression circuitry. This suppression circuitry minimizes voltage glitches at the output during turn-on and turn-off, reducing audible noise on activation and deactivation.

Other features that simplify system-level integration of the SSM2375 include input low-pass filtering to suppress out-of-band DAC noise interference to the PDM modulator and fixed-input impedance to simplify component selection across multiple platform production builds.

The SSM2375 is specified over the industrial temperature range of  $-40^{\circ}\text{C}$  to  $+85^{\circ}\text{C}$ . It has built-in thermal shutdown and output short-circuit protection. It is available in a halide-free, 9-ball, 1.5 mm  $\times$  1.5 mm wafer level chip scale package (WLCSP).

## FUNCTIONAL BLOCK DIAGRAM

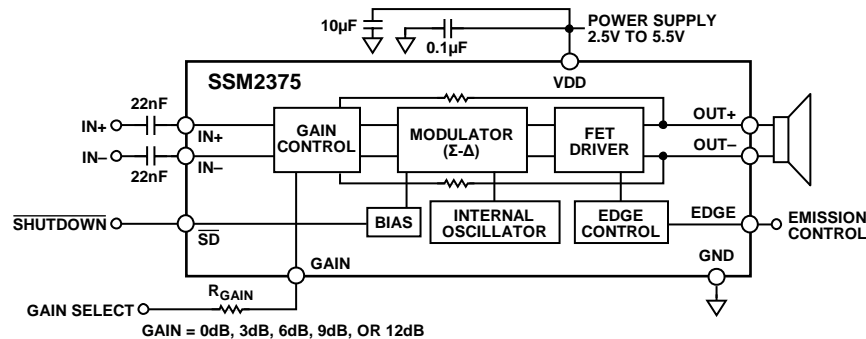

Figure 1.

Rev. A

### Document Feedback

Information furnished by Analog Devices is believed to be accurate and reliable. However, no responsibility is assumed by Analog Devices for its use, nor for any infringements of patents or other rights of third parties that may result from its use. Specifications subject to change without notice. No license is granted by implication or otherwise under any patent or patent rights of Analog Devices. Trademarks and registered trademarks are the property of their respective owners.

## TABLE OF CONTENTS

Features .....	1	Theory of Operation .....	13
Applications.....	1	Overview .....	13
General Description .....	1	Gain Selection.....	13
Functional Block Diagram .....	1	Pop-and-Click Suppression .....	13
Revision History .....	2	EMI Noise.....	13
Specifications.....	3	Output Modulation Description .....	13
Absolute Maximum Ratings.....	5	Layout .....	14
Thermal Resistance .....	5	Input Capacitor Selection.....	14
ESD Caution.....	5	Power Supply Decoupling .....	14
Pin Configuration and Function Descriptions.....	6	Outline Dimensions .....	15
Typical Performance Characteristics .....	7	Ordering Guide .....	15
Typical Application Circuits.....	12		

## REVISION HISTORY

### 4/13—Rev. 0 to Rev. A

Changes to Figure 33 and Figure 34.....	12
Changes to Gain Selection Section and Table 5 .....	13
Updated Outline Dimensions .....	15

### 9/10—Revision 0: Initial Version

## SPECIFICATIONS

$V_{DD} = 5.0\text{ V}$ ,  $T_A = 25^\circ\text{C}$ ,  $R_L = 8\ \Omega + 33\ \mu\text{H}$ , EDGE = GND, unless otherwise noted.

Table 1.

Parameter	Symbol	Test Conditions/Comments	Min	Typ	Max	Unit
<b>DEVICE CHARACTERISTICS</b>						
Output Power	$P_O$	$f = 1\text{ kHz}$ , 20 kHz BW $R_L = 8\ \Omega$ , THD = 1%, $V_{DD} = 5.0\text{ V}$ $R_L = 8\ \Omega$ , THD = 1%, $V_{DD} = 3.6\text{ V}$ $R_L = 8\ \Omega$ , THD = 1%, $V_{DD} = 2.5\text{ V}$ $R_L = 8\ \Omega$ , THD = 10%, $V_{DD} = 5.0\text{ V}$ $R_L = 8\ \Omega$ , THD = 10%, $V_{DD} = 3.6\text{ V}$ $R_L = 8\ \Omega$ , THD = 10%, $V_{DD} = 2.5\text{ V}$ $R_L = 4\ \Omega$ , THD = 1%, $V_{DD} = 5.0\text{ V}$ $R_L = 4\ \Omega$ , THD = 1%, $V_{DD} = 3.6\text{ V}$ $R_L = 4\ \Omega$ , THD = 1%, $V_{DD} = 2.5\text{ V}$ $R_L = 4\ \Omega$ , THD = 10%, $V_{DD} = 5.0\text{ V}$ $R_L = 4\ \Omega$ , THD = 10%, $V_{DD} = 3.6\text{ V}$ $R_L = 4\ \Omega$ , THD = 10%, $V_{DD} = 2.5\text{ V}$ $R_L = 3\ \Omega$ , THD = 1%, $V_{DD} = 5.0\text{ V}$ $R_L = 3\ \Omega$ , THD = 1%, $V_{DD} = 3.6\text{ V}$ $R_L = 3\ \Omega$ , THD = 1%, $V_{DD} = 2.5\text{ V}$ $R_L = 3\ \Omega$ , THD = 10%, $V_{DD} = 5.0\text{ V}$ $R_L = 3\ \Omega$ , THD = 10%, $V_{DD} = 3.6\text{ V}$ $R_L = 3\ \Omega$ , THD = 10%, $V_{DD} = 2.5\text{ V}$				
Efficiency	$\eta$	$P_O = 1.4\text{ W}$ into $8\ \Omega$ , $V_{DD} = 5.0\text{ V}$		93		%
Total Harmonic Distortion + Noise	THD + N	$P_O = 1\text{ W}$ into $8\ \Omega$ , $f = 1\text{ kHz}$ , $V_{DD} = 5.0\text{ V}$ $P_O = 0.5\text{ W}$ into $8\ \Omega$ , $f = 1\text{ kHz}$ , $V_{DD} = 3.6\text{ V}$		0.01		%
Input Common-Mode Voltage Range	$V_{CM}$		1.0		$V_{DD} - 1$	V
Common-Mode Rejection Ratio	$CMRR_{GSM}$	$V_{CM} = 2.5\text{ V} \pm 100\text{ mV}$ , $f = 217\text{ Hz}$ , output referred		55		dB
Average Switching Frequency	$f_{SW}$			250		kHz
Differential Output Offset Voltage	$V_{OOS}$	Gain = 6 dB		0.1	2.0	mV
<b>POWER SUPPLY</b>						
Supply Voltage Range	$V_{DD}$	Guaranteed from PSRR test	2.5		5.5	V
Power Supply Rejection Ratio	PSRR	Inputs are ac-grounded, $C_{IN} = 0.1\ \mu\text{F}$ $V_{RIPPLE} = 100\text{ mV}$ at 217 Hz $V_{RIPPLE} = 100\text{ mV}$ at 1 kHz		80		dB
Supply Current	$I_{SY}$	$V_{IN} = 0\text{ V}$ , no load, $V_{DD} = 5.0\text{ V}$ $V_{IN} = 0\text{ V}$ , no load, $V_{DD} = 3.6\text{ V}$ $V_{IN} = 0\text{ V}$ , no load, $V_{DD} = 2.5\text{ V}$ $V_{IN} = 0\text{ V}$ , $R_L = 8\ \Omega + 33\ \mu\text{H}$ , $V_{DD} = 5.0\text{ V}$ $V_{IN} = 0\text{ V}$ , $R_L = 8\ \Omega + 33\ \mu\text{H}$ , $V_{DD} = 3.6\text{ V}$ $V_{IN} = 0\text{ V}$ , $R_L = 8\ \Omega + 33\ \mu\text{H}$ , $V_{DD} = 2.5\text{ V}$		3.0		mA
Shutdown Current	$I_{SD}$	$\overline{SD} = \text{GND}$		2.6		mA
				20		nA
<b>GAIN CONTROL</b>						
Closed-Loop Gain	Gain		0		12	dB
Input Impedance	$Z_{IN}$	$\overline{SD} = V_{DD}$ , fixed input impedance (0 dB to 12 dB)		80		k $\Omega$
<b>SHUTDOWN CONTROL</b>						
Input Voltage High	$V_{IH}$		1.35			V
Input Voltage Low	$V_{IL}$				0.35	V
Turn-On Time	$t_{WU}$	$\overline{SD}$ rising edge from GND to VDD		12.5		ms
Turn-Off Time	$t_{SD}$	$\overline{SD}$ falling edge from VDD to GND		5		$\mu\text{s}$
Output Impedance	$Z_{OUT}$	$\overline{SD} = \text{GND}$		>100		k $\Omega$

Parameter	Symbol	Test Conditions/Comments	Min	Typ	Max	Unit
NOISE PERFORMANCE						
Output Voltage Noise	$e_n$	$V_{DD} = 5.0\text{ V}$ , $f = 20\text{ Hz to }20\text{ kHz}$ , inputs are ac-grounded, gain = 6 dB, A-weighted		30		$\mu\text{V rms}$
Signal-to-Noise Ratio	SNR	$P_o = 1.4\text{ W}$ , $R_L = 8\ \Omega$		100		dB

<sup>1</sup> Although the SSM2375 has good audio quality above 3 W, continuous output power beyond 3 W without a heat sink must be avoided due to device packaging limitations.

## ABSOLUTE MAXIMUM RATINGS

Absolute maximum ratings apply at 25°C, unless otherwise noted.

Table 2.

Parameter	Rating
Supply Voltage	6 V
Input Voltage	$V_{DD}$
Common-Mode Input Voltage	$V_{DD}$
Storage Temperature Range	-65°C to +150°C
Operating Temperature Range	-40°C to +85°C
Junction Temperature Range	-65°C to +165°C
Lead Temperature (Soldering, 60 sec)	300°C
ESD Susceptibility	4 kV

Stresses above those listed under Absolute Maximum Ratings may cause permanent damage to the device. This is a stress rating only; functional operation of the device at these or any other conditions above those indicated in the operational section of this specification is not implied. Exposure to absolute maximum rating conditions for extended periods may affect device reliability.

## THERMAL RESISTANCE

$\theta_{JA}$  is specified for the worst-case conditions, that is, a device soldered in a circuit board for surface-mount packages.

Table 3. Thermal Resistance

Package Type	PCB	$\theta_{JA}$	$\theta_{JB}$	Unit
9-Ball, 1.5 mm × 1.5 mm WLCSP	1S0P	162	39	°C/W
	2S0P	76	21	°C/W

## ESD CAUTION



**ESD (electrostatic discharge) sensitive device.** Charged devices and circuit boards can discharge without detection. Although this product features patented or proprietary protection circuitry, damage may occur on devices subjected to high energy ESD. Therefore, proper ESD precautions should be taken to avoid performance degradation or loss of functionality.

## PIN CONFIGURATION AND FUNCTION DESCRIPTIONS

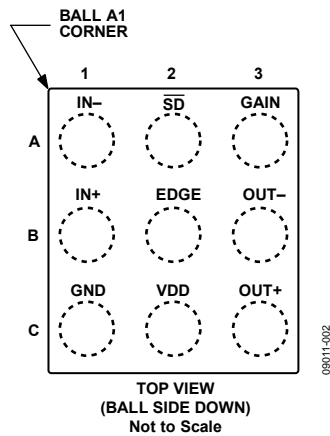

Figure 2. Pin Configuration

Table 4. Pin Function Descriptions

Pin No.	Mnemonic	Description
1A	IN-	Inverting Input.
1B	IN+	Noninverting Input.
1C	GND	Ground.
2A	$\overline{SD}$	Shutdown Input. Active low digital input.
2B	EDGE	Edge Rate Control. Active high.
2C	VDD	Power Supply.
3A	GAIN	Gain Control Pin.
3B	OUT-	Inverting Output.
3C	OUT+	Noninverting Output.

# TYPICAL PERFORMANCE CHARACTERISTICS

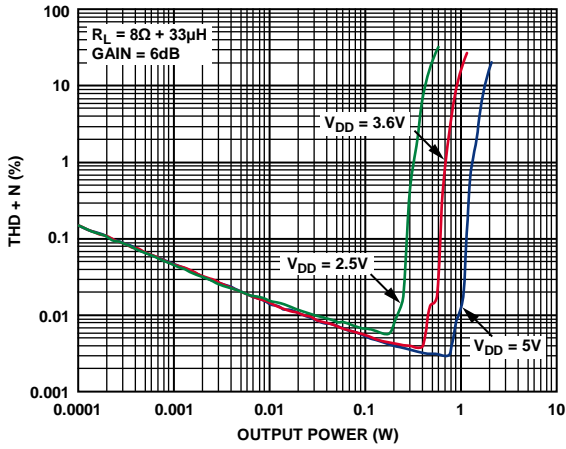

Figure 3. THD + N vs. Output Power into 8 Ω, Gain = 6 dB

09011-003

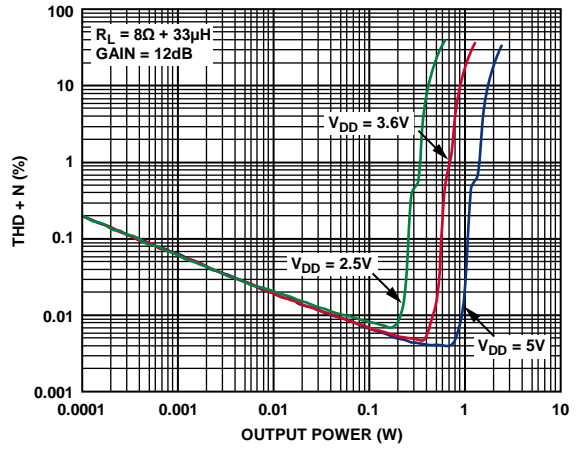

Figure 6. THD + N vs. Output Power into 8 Ω, Gain = 12 dB

09011-004

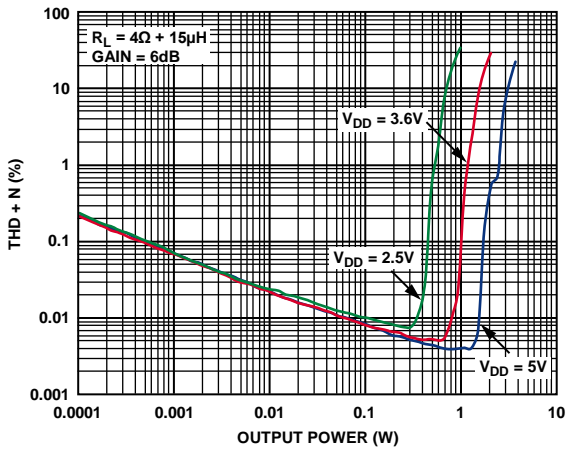

Figure 4. THD + N vs. Output Power into 4 Ω, Gain = 6 dB

09011-010

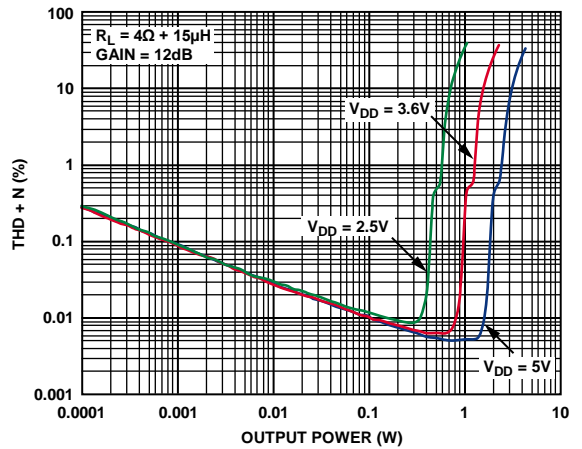

Figure 7. THD + N vs. Output Power into 4 Ω, Gain = 12 dB

09011-011

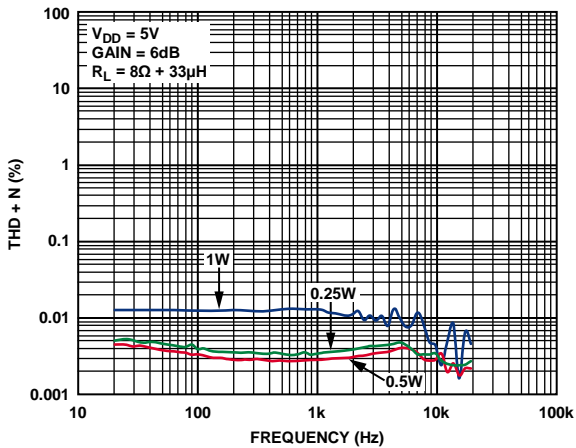

Figure 5. THD + N vs. Frequency,  $V_{DD} = 5\text{ V}$ ,  $R_L = 8\ \Omega$ , Gain = 6 dB

09011-012

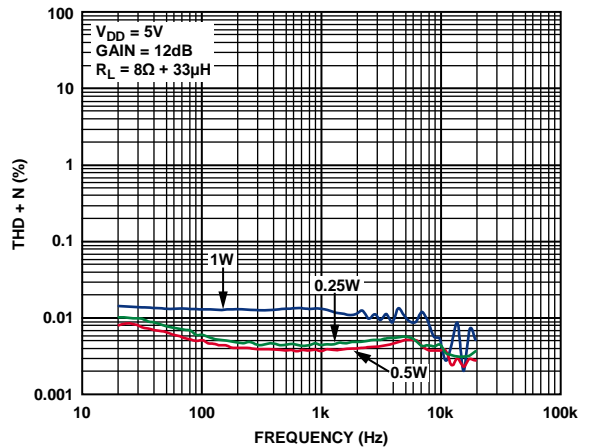

Figure 8. THD + N vs. Frequency,  $V_{DD} = 5\text{ V}$ ,  $R_L = 8\ \Omega$ , Gain = 12 dB

09011-013

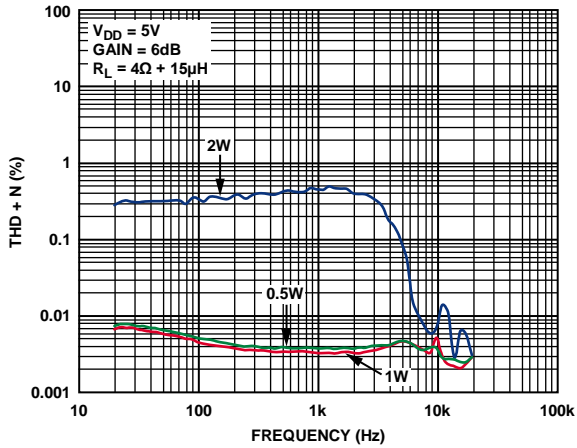

Figure 9. THD + N vs. Frequency,  $V_{DD} = 5V$ ,  $R_L = 4\Omega$ , Gain = 6 dB

09011-014

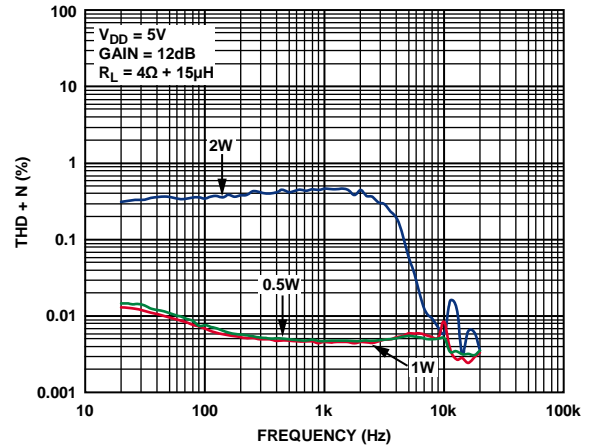

Figure 12. THD + N vs. Frequency,  $V_{DD} = 5V$ ,  $R_L = 4\Omega$ , Gain = 12 dB

09011-015

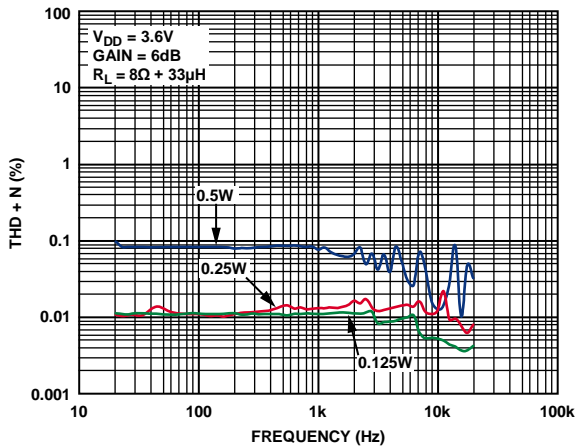

Figure 10. THD + N vs. Frequency,  $V_{DD} = 3.6V$ ,  $R_L = 8\Omega$ , Gain = 6 dB

09011-016

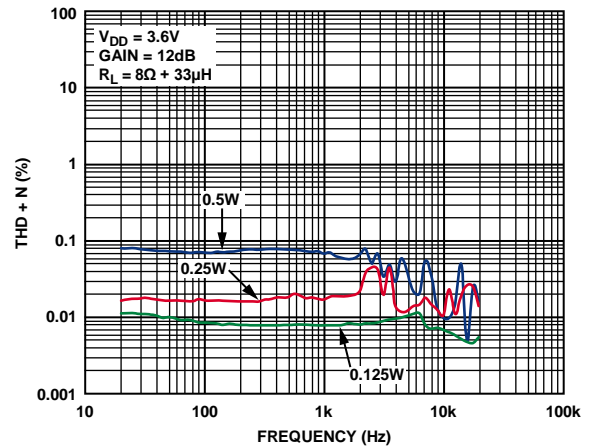

Figure 13. THD + N vs. Frequency,  $V_{DD} = 3.6V$ ,  $R_L = 8\Omega$ , Gain = 12 dB

09011-017

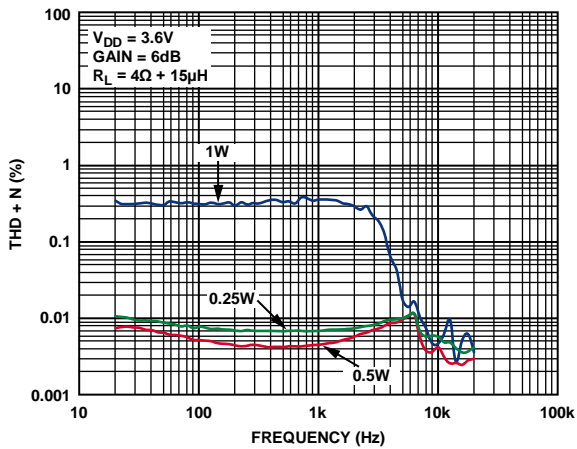

Figure 11. THD + N vs. Frequency,  $V_{DD} = 3.6V$ ,  $R_L = 4\Omega$ , Gain = 6 dB

09011-018

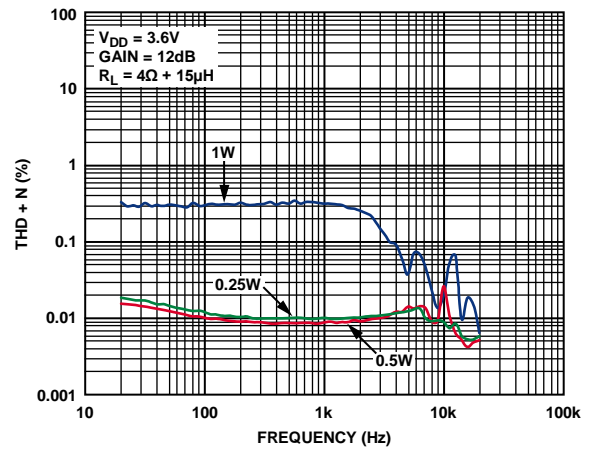

Figure 14. THD + N vs. Frequency,  $V_{DD} = 3.6V$ ,  $R_L = 4\Omega$ , Gain = 12 dB

09011-019



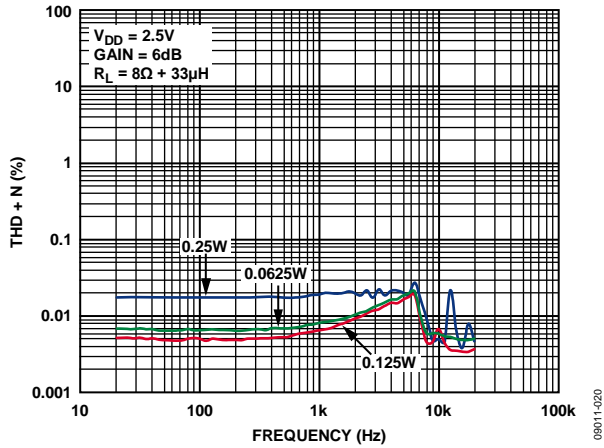

Figure 15. THD + N vs. Frequency,  $V_{DD} = 2.5V$ ,  $R_L = 8\Omega$ , Gain = 6 dB

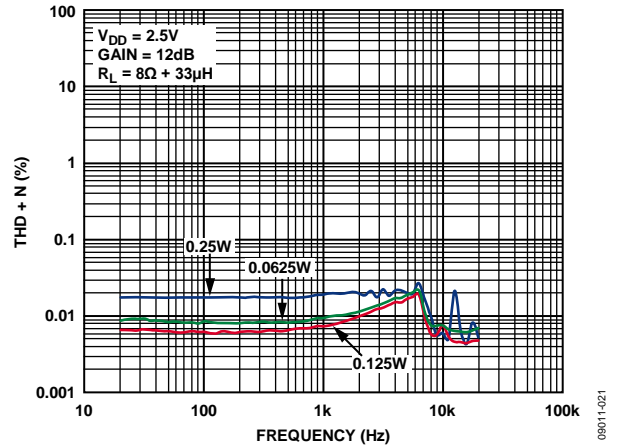

Figure 18. THD + N vs. Frequency,  $V_{DD} = 2.5V$ ,  $R_L = 8\Omega$ , Gain = 12 dB

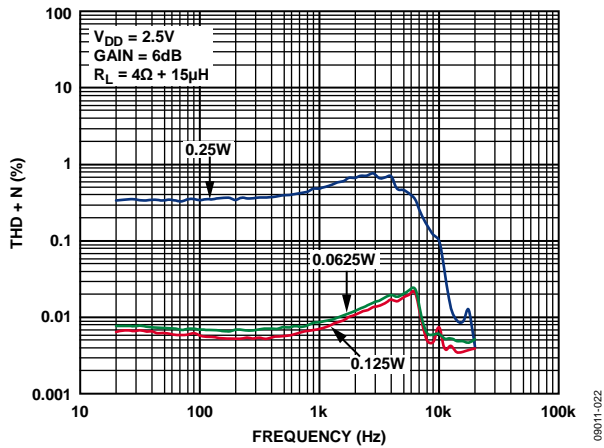

Figure 16. THD + N vs. Frequency,  $V_{DD} = 2.5V$ ,  $R_L = 4\Omega$ , Gain = 6 dB

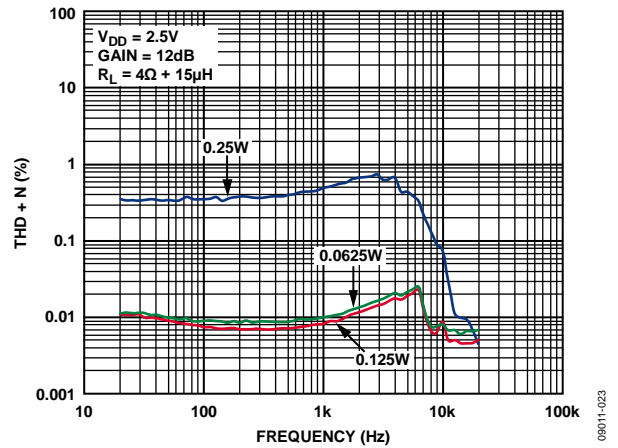

Figure 19. THD + N vs. Frequency,  $V_{DD} = 2.5V$ ,  $R_L = 4\Omega$ , Gain = 12 dB

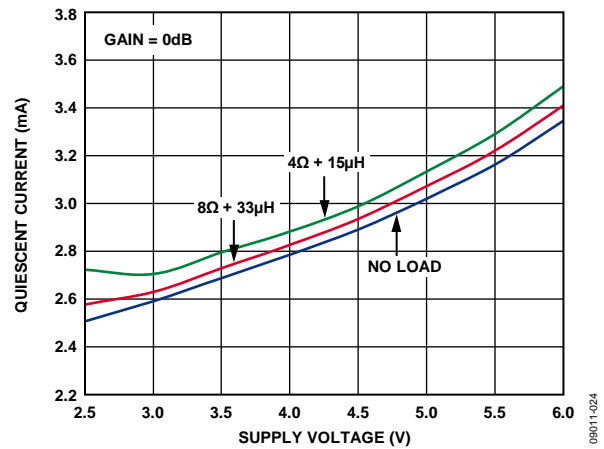

Figure 17. Quiescent Current vs. Supply Voltage, Gain = 0 dB

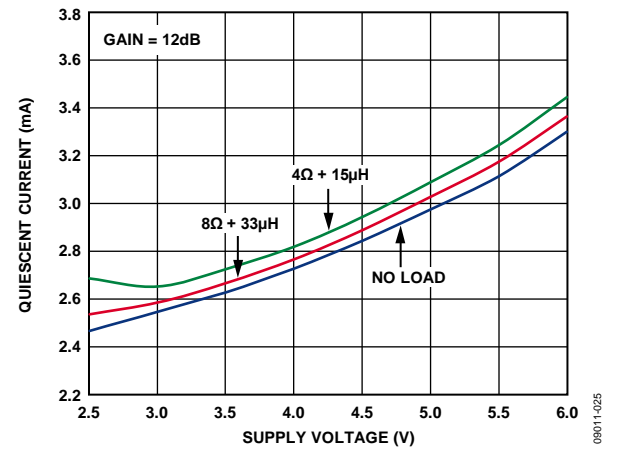

Figure 20. Quiescent Current vs. Supply Voltage, Gain = 12 dB

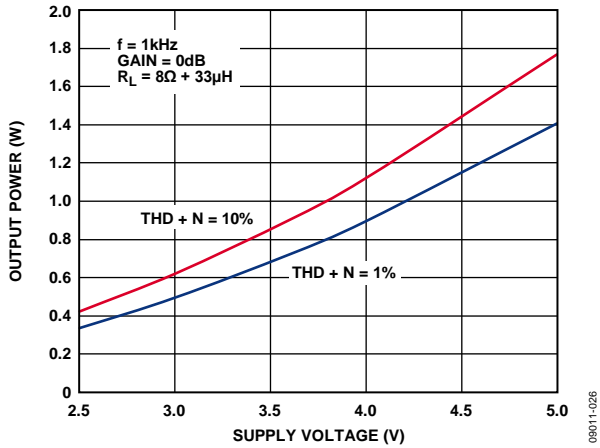

Figure 21. Maximum Output Power vs. Supply Voltage,  $R_L = 8\ \Omega$ , Gain = 0 dB

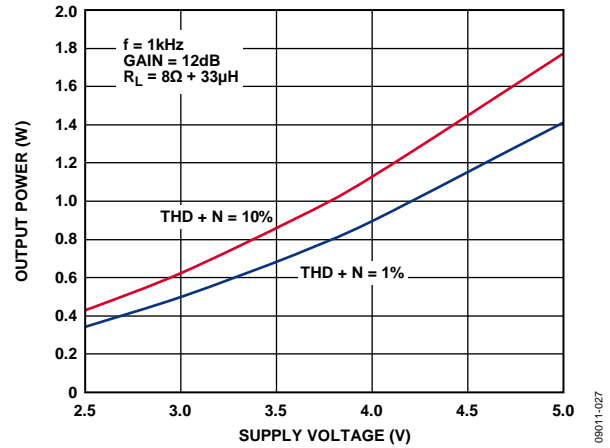

Figure 24. Maximum Output Power vs. Supply Voltage,  $R_L = 8\ \Omega$ , Gain = 12 dB

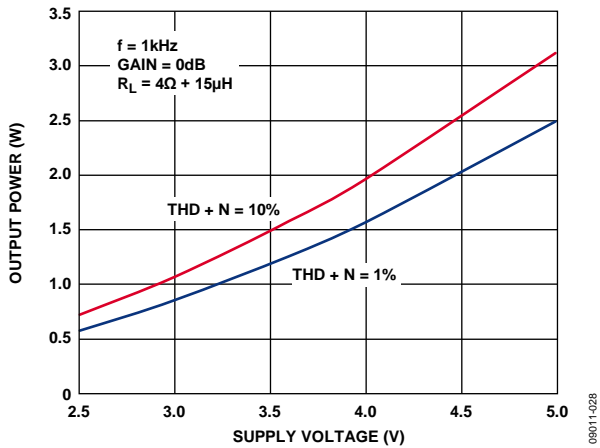

Figure 22. Maximum Output Power vs. Supply Voltage,  $R_L = 4\ \Omega$ , Gain = 0 dB

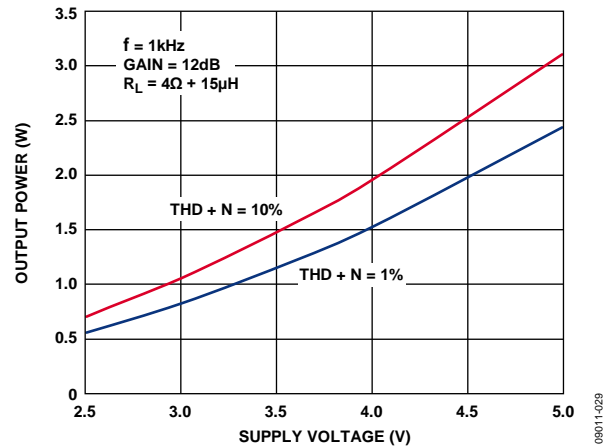

Figure 25. Maximum Output Power vs. Supply Voltage,  $R_L = 4\ \Omega$ , Gain = 12 dB

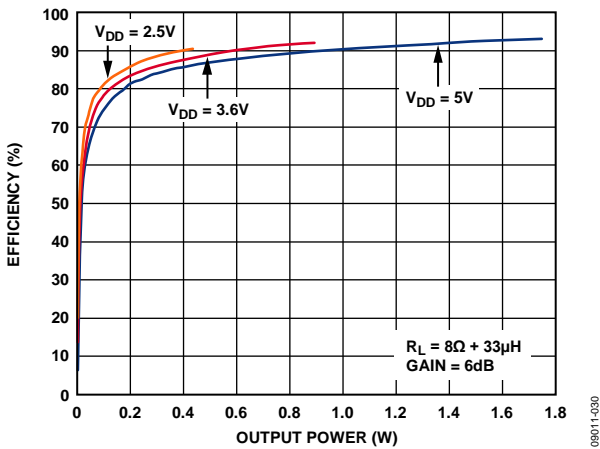

Figure 23. Efficiency vs. Output Power into 8  $\Omega$ , Gain = 6 dB

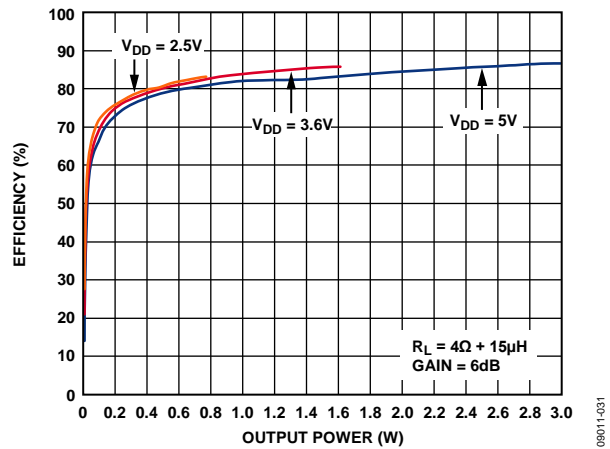

Figure 26. Efficiency vs. Output Power into 4  $\Omega$ , Gain = 6 dB

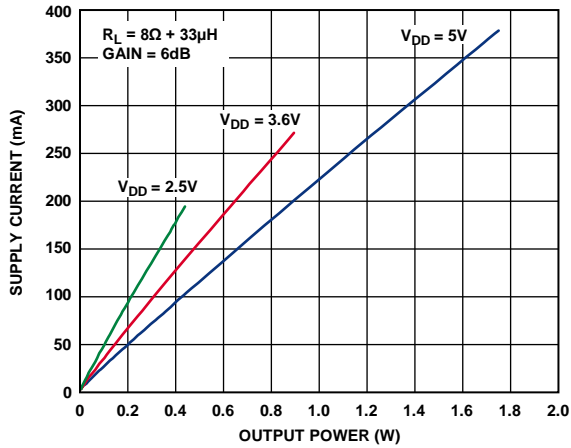

Figure 27. Supply Current vs. Output Power into 8Ω, Gain = 6 dB

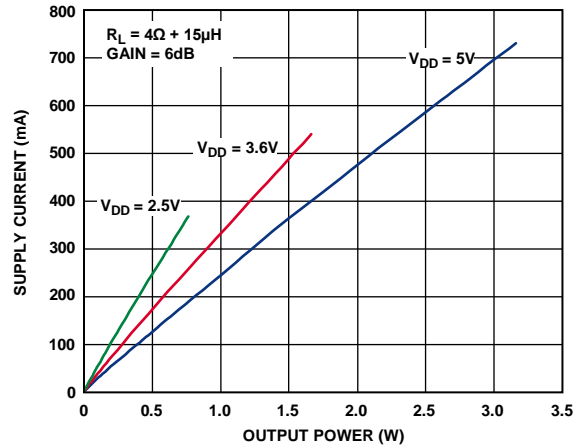

Figure 30. Supply Current vs. Output Power into 4Ω, Gain = 6 dB

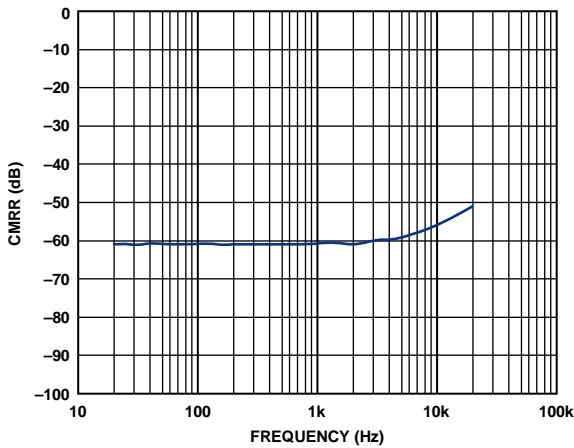

Figure 28. Common-Mode Rejection Ratio (CMRR) vs. Frequency

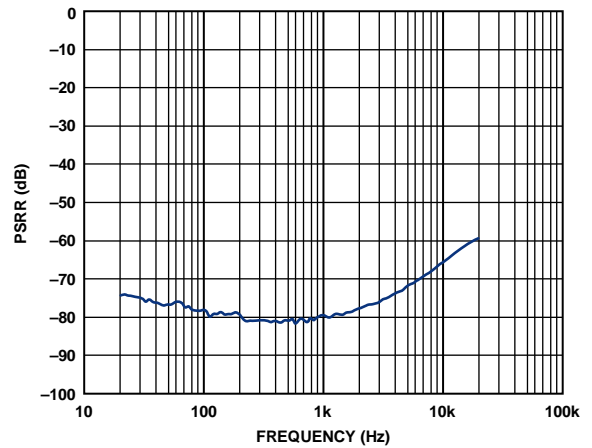

Figure 31. Power Supply Rejection Ratio (PSRR) vs. Frequency

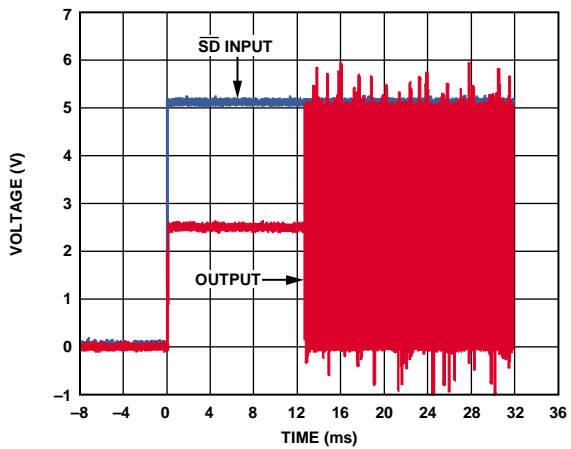

Figure 29. Turn-On Response

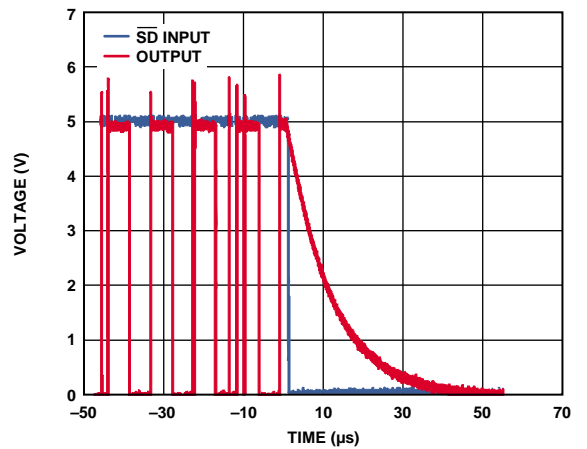
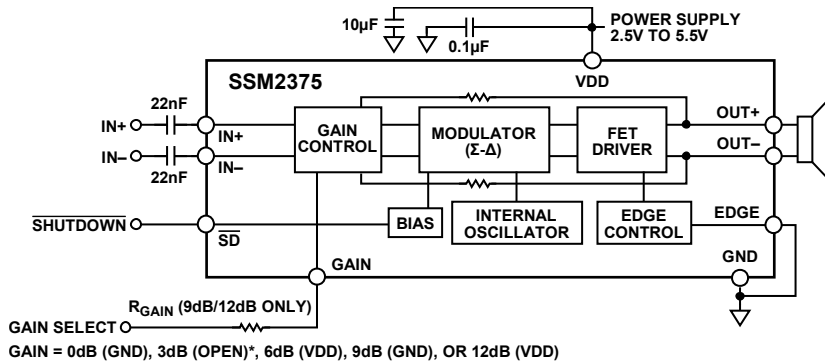

Figure 32. Turn-Off Response

TYPICAL APPLICATION CIRCUITS



\*SEE THE GAIN SELECTION SECTION FOR MORE INFORMATION ON AVOIDING EXCESSIVE INDUCED NOISE.

Figure 33. Monaural Differential Input Configuration

09011-005

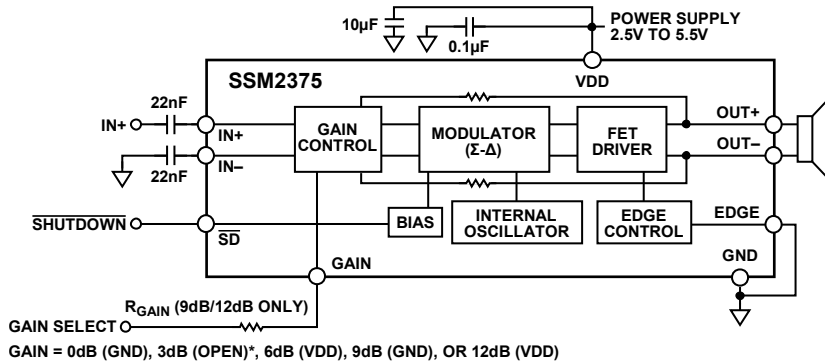

\*SEE THE GAIN SELECTION SECTION FOR MORE INFORMATION ON AVOIDING EXCESSIVE INDUCED NOISE.

Figure 34. Monaural Single-Ended Input Configuration

09011-006

## THEORY OF OPERATION

### OVERVIEW

The SSM2375 mono Class-D audio amplifier features a filterless modulation scheme that greatly reduces the external component count, conserving board space and, thus, reducing systems cost. The SSM2375 does not require an output filter but, instead, relies on the inherent inductance of the speaker coil and the natural filtering of the speaker and human ear to fully recover the audio component of the switching output.

Most Class-D amplifiers use some variation of pulse-width modulation (PWM), but the SSM2375 uses  $\Sigma$ - $\Delta$  modulation to determine the switching pattern of the output devices, resulting in a number of important benefits.

- $\Sigma$ - $\Delta$  modulators do not produce a sharp peak with many harmonics in the AM frequency band, as pulse-width modulators often do.
- $\Sigma$ - $\Delta$  modulation provides the benefits of reducing the amplitude of spectral components at high frequencies, that is, reducing EMI emissions that might otherwise be radiated by speakers and long cable traces.
- Due to the inherent spread-spectrum nature of  $\Sigma$ - $\Delta$  modulation, the need for oscillator synchronization is eliminated for designs that incorporate multiple SSM2375 amplifiers.

The SSM2375 also integrates overcurrent and overtemperature protection.

### GAIN SELECTION

The preset gain of the SSM2375 can be set from 0 dB to 12 dB in 3 dB steps with one external resistor (optional). The external resistor is used to select the 9 dB or 12 dB gain setting, as shown in Table 5.

To avoid excessive induced noise at high output power, observe caution under the following conditions: GAIN pin is configured to the 3 dB gain setting (open) and using both low impedance (less than  $3\ \Omega + 10\ \mu\text{H}$ ) loading and configured for low emissions mode (EDGE = VDD). To safeguard against the potential induced noise at high power levels in this configuration, connect a capacitor from GAIN to GND with a value ranging from 2.2  $\mu\text{F}$  to 4.7  $\mu\text{F}$ . Alternatively, apply a fixed voltage of VDD/2 to the GAIN pin to stabilize the gain setting operation under the low impedance/high power condition stated above.

**Table 5. Gain Function Descriptions**

Gain Setting (dB)	GAIN Pin Configuration
12	Tie to VDD through 47 k $\Omega$ resistor
9	Tie to GND through 47 k $\Omega$ resistor
6	Tie to VDD
3 <sup>1</sup>	Open
0	Tie to GND

<sup>1</sup> See the Gain Selection section for more information on avoiding excessive induced noise.

### POP-AND-CLICK SUPPRESSION

Voltage transients at the output of audio amplifiers can occur when shutdown is activated or deactivated. Voltage transients as low as 10 mV can be heard as an audio pop in a low sensitivity handset speaker. Clicks and pops can also be classified as undesirable audible transients generated by the amplifier system and, therefore, as not coming from the system input signal.

The SSM2375 has a pop-and-click suppression architecture that reduces these output transients, resulting in noiseless activation and deactivation from the  $\overline{\text{SD}}$  control pin while operating in a typical audio configuration.

### EMI NOISE

The SSM2375 uses a proprietary modulation and spread-spectrum technology to minimize EMI emissions from the device. For applications that have difficulty passing FCC Class B emission tests, the SSM2375 includes a modulation select pin (ultralow EMI emissions mode) that significantly reduces the radiated emissions at the Class-D outputs, particularly above 100 MHz.

EMI emission tests on the SSM2375 were performed in a certified FCC Class B laboratory in low emissions mode (EDGE = VDD). With a pink noise source, an 8  $\Omega$  speaker load, and a 5 V supply, the SSM2375 was able to pass FCC Class B limits with 50 cm, unshielded twisted pair speaker cable. Note that reducing the power supply voltage greatly reduces radiated emissions.

### OUTPUT MODULATION DESCRIPTION

The SSM2375 uses three-level,  $\Sigma$ - $\Delta$  output modulation. Each output can swing from GND to V<sub>DD</sub> and vice versa. Ideally, when no input signal is present, the output differential voltage is 0 V because there is no need to generate a pulse. In a real-world situation, there are always noise sources present.

Due to this constant presence of noise, a differential pulse is generated, when required, in response to this stimulus. A small amount of current flows into the inductive load when the differential pulse is generated.

Most of the time, however, the output differential voltage is 0 V, due to the Analog Devices, Inc., three-level,  $\Sigma$ - $\Delta$  output modulation. This feature ensures that the current flowing through the inductive load is small.

When the user wants to send an input signal, an output pulse is generated to follow the input voltage. The differential pulse density is increased by raising the input signal level. Figure 35 depicts three-level,  $\Sigma$ - $\Delta$  output modulation with and without input stimulus.

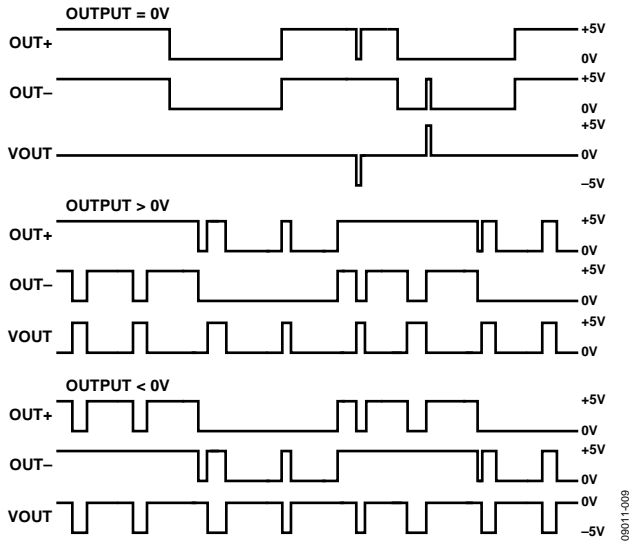

Figure 35. Three-Level,  $\Sigma$ - $\Delta$  Output Modulation With and Without Input Stimulus

## LAYOUT

As output power increases, care must be taken to lay out PCB traces and wires properly among the amplifier, load, and power supply. A good practice is to use short, wide PCB tracks to decrease voltage drops and minimize inductance. The PCB layout engineer must avoid ground loops where possible to minimize common-mode current associated with separate paths to ground. Ensure that track widths are at least 200 mil for every inch of track length for lowest DCR, and use 1 oz or 2 oz copper PCB traces to further reduce IR drops and inductance. A poor layout increases voltage drops, consequently affecting efficiency. Use large traces for the power supply inputs and amplifier outputs to minimize losses due to parasitic trace resistance.

Proper grounding guidelines help to improve audio performance, minimize crosstalk between channels, and prevent switching noise from coupling into the audio signal. To maintain high output swing and high peak output power, the PCB traces that connect the output pins to the load, as well as the PCB traces to the supply pins, should be as wide as possible to maintain the minimum trace resistances. It is also recommended that a large ground plane be used for minimum impedances.

In addition, good PCB layout isolates critical analog paths from sources of high interference. High frequency circuits (analog and digital) should be separated from low frequency circuits.

Properly designed multilayer PCBs can reduce EMI emissions and increase immunity to the RF field by a factor of 10 or more, compared with double-sided boards. A multilayer board allows a complete layer to be used for the ground plane, whereas the ground plane side of a double-sided board is often disrupted by signal crossover.

## INPUT CAPACITOR SELECTION

The SSM2375 does not require input coupling capacitors if the input signal is biased from 1.0 V to  $V_{DD} - 1.0$  V. Input capacitors are required if the input signal is not biased within this recommended input dc common-mode voltage range, if high-pass filtering is needed, or if a single-ended source is used. If high-pass filtering is needed at the input, the input capacitor and the input resistor of the SSM2375 form a high-pass filter whose corner frequency is determined by the following equation:

$$f_c = 1/(2\pi \times R_{IN} \times C_{IN})$$

The input capacitor can significantly affect the performance of the circuit. Not using input capacitors degrades both the output offset of the amplifier and the dc PSRR performance.

## POWER SUPPLY DECOUPLING

To ensure high efficiency, low total harmonic distortion (THD), and high PSRR, proper power supply decoupling is necessary. Noise transients on the power supply lines are short-duration voltage spikes. These spikes can contain frequency components that extend into the hundreds of megahertz. The power supply input must be decoupled with a good quality, low ESL, low ESR capacitor, with a minimum value of 4.7  $\mu$ F. This capacitor bypasses low frequency noises to the ground plane. For high frequency transient noises, use a 0.1  $\mu$ F capacitor as close as possible to the VDD pin of the device. Placing the decoupling capacitors as close as possible to the SSM2375 helps to maintain efficient performance.

# OUTLINE DIMENSIONS

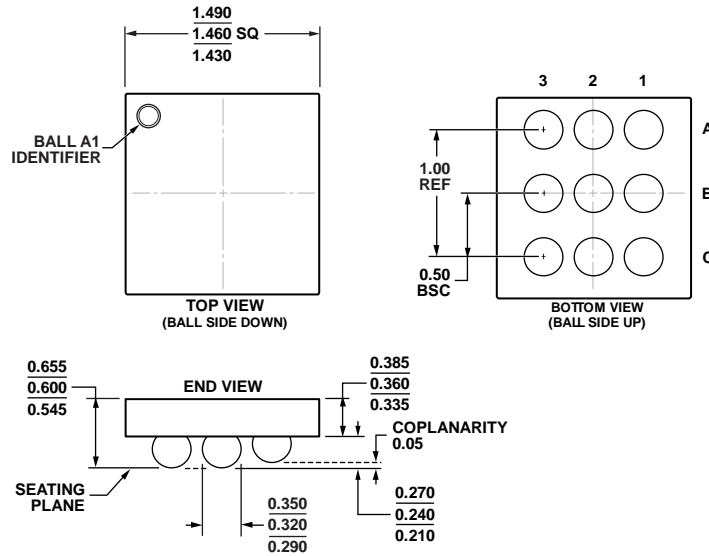

Figure 36. 9-Ball Wafer Level Chip Scale Package [WLCSP]  
(CB-9-2)  
Dimensions shown in millimeters

09-04-2012-C

## ORDERING GUIDE

Model <sup>1</sup>	Temperature Range	Package Description	Package Option <sup>2</sup>
SSM2375CBZ-REEL	-40°C to +85°C	9-Ball Wafer Level Chip Scale Package [WLCSP]	CB-9-2
SSM2375CBZ-REEL7	-40°C to +85°C	9-Ball Wafer Level Chip Scale Package [WLCSP]	CB-9-2
EVAL-SSM2375Z		Evaluation Board	

<sup>1</sup> Z = RoHS Compliant Part.

<sup>2</sup> This package option is halide free.

**NOTES**