

TinyLogic ULP-A 2-Input Non-Inverting Multiplexer

NC7SV157

The NC7SV157 is a single 2-input non-inverting multiplexer in tiny footprint packages. The device is designed to operate for $V_{CC} = 0.9\text{ V}$ to 3.6 V .

Features

- Designed for 0.9 V to 3.6 V V_{CC} Operation
- 1.9 ns t_{PD} at 3.3 V (Typ)
- Inputs/Outputs Over-Voltage Tolerant up to 3.6 V
- I_{OFF} Supports Partial Power Down Protection
- Source/Sink 24 mA at 3.3 V
- Available in SC-88A and MicroPak™ Packages
- These Devices are Pb-Free, Halogen Free/BFR Free and are RoHS Compliant

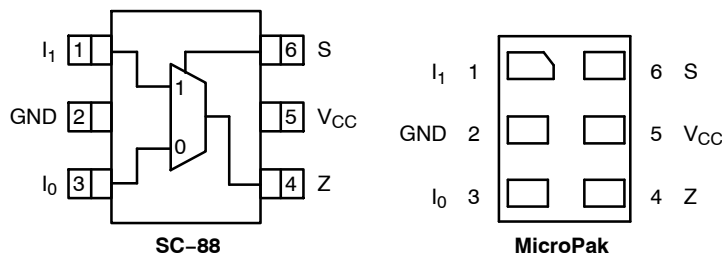

Figure 1. Pinout Diagrams (Top Views)

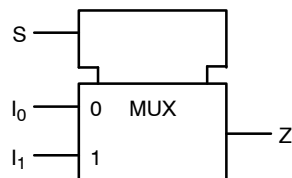

Figure 2. Logic Symbol

PIN ASSIGNMENT

Pin	Function
1	I1
2	GND
3	I0
4	Z
5	V_{CC}
6	S

FUNCTION TABLE

Inputs			Output
S	I1	I0	$Z = (I_0) \cdot (\bar{S}) + (I_1) \cdot (S)$
L	X	L	L
L	X	H	H
H	L	X	L
H	H	X	H

H = HIGH Logic Level
L = LOW Logic Level
X = Don't Care

MARKING DIAGRAMS



SIP6 1.45X1.0
MicroPak
CASE 127EB

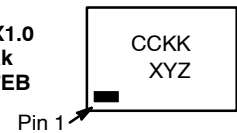

CC = Specific Device Code
KK = 2-Digit Lot Run Traceability Code
XY = 2-Digit Date Code
Z = Assembly Plant Code



SC-88
CASE 419B-02

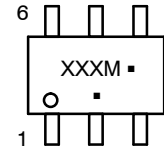

XXX = Specific Device Code
M = Date Code
▪ = Pb-Free Package

ORDERING INFORMATION

See detailed ordering, marking and shipping information on page 6 of this data sheet.

NC7SV157

MAXIMUM RATINGS

Symbol	Characteristics	Value	Unit
V_{CC}	DC Supply Voltage	-0.5 to +4.3	V
V_{IN}	DC Input Voltage	-0.5 to +4.3	V
V_{OUT}	DC Output Voltage Active-Mode (High or Low State) Tri-State Mode (Note 1) Power-Down Mode ($V_{CC} = 0$ V)	-0.5 to $V_{CC} + 0.5$ -0.5 to +4.3 -0.5 to +4.3	V
I_{IK}	DC Input Diode Current $V_{IN} < GND$	-50	mA
I_{OK}	DC Output Diode Current $V_{OUT} < GND$	-50	mA
I_{OUT}	DC Output Source/Sink Current	± 50	mA
I_{CC} or I_{GND}	DC Supply Current per Supply Pin or Ground Pin	± 50	mA
T_{STG}	Storage Temperature Range	-65 to +150	$^{\circ}C$
T_L	Lead Temperature, 1 mm from Case for 10 Seconds	260	$^{\circ}C$
T_J	Junction Temperature Under Bias	+150	$^{\circ}C$
θ_{JA}	Thermal Resistance (Note 2)	SC-88A MicroPak 377 154	$^{\circ}C/W$
P_D	Power Dissipation in Still Air	SC-88A MicroPak 332 812	mW
MSL	Moisture Sensitivity	Level 1	-
F_R	Flammability Rating Oxygen Index: 28 to 34	UL 94 V-0 @ 0.125 in	-
V_{ESD}	ESD Withstand Voltage (Note 3) Human Body Model Charged Device Model	2000 1000	V
$I_{Latchup}$	Latchup Performance (Note 4)	± 100	mA

Stresses exceeding those listed in the Maximum Ratings table may damage the device. If any of these limits are exceeded, device functionality should not be assumed, damage may occur and reliability may be affected.

1. Applicable to devices with outputs that may be tri-stated.
2. Measured with minimum pad spacing on an FR4 board, using 10 mm-by-1 inch, 2 ounce copper trace no air flow per JESD51-7.
3. HBM tested to EIA / JESD22-A114-A. CDM tested to JESD22-C101-A. JEDEC recommends that ESD qualification to EIA/JESD22-A115A (Machine Model) be discontinued.
4. Tested to EIA/JESD78 Class II.

NC7SV157

RECOMMENDED OPERATING CONDITIONS

Symbol	Parameter	Min	Max	Unit
V _{CC}	Positive DC Supply Voltage	0.9	3.6	V
V _{IN}	DC Input Voltage	0	3.6	V
V _{OUT}	DC Output Voltage Active-Mode (High or Low State) Tri-State Mode (Note 1) Power-Down Mode (V _{CC} = 0 V)	0	V _{CC}	
		0	3.6	
		0	3.6	
T _A	Operating Temperature Range	-40	+85	°C
t _r , t _f	Input Transition Rise and Fall Time V _{CC} = 3.3 V ± 0.3 V	0	10	ns/V

Functional operation above the stresses listed in the Recommended Operating Ranges is not implied. Extended exposure to stresses beyond the Recommended Operating Ranges limits may affect device reliability.

DC ELECTRICAL CHARACTERISTICS

Symbol	Parameter	Condition	V _{CC} (V)	T _A = 25°C			T _A = -40°C to +85°C		Unit
				Min	Typ	Max	Min	Max	
V _{IH}	High-Level Input Voltage		0.9	-	0.5	-	-	-	V
			1.1 to 1.3	0.65 x V _{CC}	-	-	0.65 x V _{CC}	-	
			1.4 to 1.6	0.65 x V _{CC}	-	-	0.65 x V _{CC}	-	
			1.65 to 1.95	0.65 x V _{CC}	-	-	0.65 x V _{CC}	-	
			2.3 to <2.7	1.6	-	-	1.6	-	
			2.7 to 3.6	2.0	-	-	2.0	-	
V _{IL}	Low-Level Input Voltage		0.9	-	0.5	-	-	-	V
			1.1 to 1.3	-	-	0.35 x V _{CC}	-	0.35 x V _{CC}	
			1.4 to 1.6	-	-	0.35 x V _{CC}	-	0.35 x V _{CC}	
			1.65 to 1.95	-	-	0.35 x V _{CC}	-	0.35 x V _{CC}	
			2.3 to <2.7	-	-	0.7	-	0.7	
			2.7 to 3.6	-	-	0.8	-	0.8	
V _{OH}	High-Level Output Voltage	V _{IN} = V _{IH} or V _{IL}							V
		I _{OH} = -100 μA	0.9	-	V _{CC} - 0.1	-	-	-	
			1.1 to 1.3	V _{CC} - 0.1	-	-	V _{CC} - 0.1	-	
			1.4 to 1.6	V _{CC} - 0.1	-	-	V _{CC} - 0.1	-	
			1.65 to 1.95	V _{CC} - 0.2	-	-	V _{CC} - 0.2	-	
			2.3 to <2.7	V _{CC} - 0.2	-	-	V _{CC} - 0.2	-	
			2.7 to 3.6	V _{CC} - 0.2	-	-	V _{CC} - 0.2	-	
		I _{OH} = -2 mA	1.1 to 1.3	0.75 x V _{CC}	-	-	0.75 x V _{CC}	-	
			1.4 to 1.6	0.75 x V _{CC}	-	-	0.75 x V _{CC}	-	
		I _{OH} = -4 mA	1.65 to 1.95	1.25	-	-	1.25	-	
			2.3 to <2.7	2.0	-	-	2.0	-	
		I _{OH} = -6 mA	2.3 to <2.7	1.8	-	-	1.8	-	
			2.7 to 3.6	2.2	-	-	2.2	-	
		I _{OH} = -12 mA	2.3 to <2.7	1.7	-	-	1.7	-	
			2.7 to 3.6	2.4	-	-	2.4	-	
I _{OH} = -18 mA	2.7 to 3.6	2.2	-	-	2.2	-			
	2.7 to 3.6	2.2	-	-	2.2	-			

NC7SV157

DC ELECTRICAL CHARACTERISTICS (continued)

Symbol	Parameter	Condition	V _{CC} (V)	T _A = 25°C			T _A = -40°C to +85°C		Unit	
				Min	Typ	Max	Min	Max		
V _{OL}	Low-Level Output Voltage	V _{IN} = V _{IH} or V _{IL}							V	
		I _{OL} = 100 μA	0.9	-	0.1	-	-	-		-
			1.1 to 1.3	-	-	0.1	-	0.1		-
			1.4 to 1.6	-	-	0.1	-	0.1		-
			1.65 to 1.95	-	-	0.2	-	0.2		-
			2.3 to <2.7	-	-	0.2	-	0.2		-
			2.7 to 3.6	-	-	0.2	-	0.2		-
		I _{OL} = 2 mA	1.1 to 1.3	-	-	0.25 x V _{CC}	-	0.25 x V _{CC}		-
		I _{OL} = 4 mA	1.4 to 1.6	-	-	0.25 x V _{CC}	-	0.25 x V _{CC}		-
		I _{OL} = 6 mA	1.65 to 1.95	-	-	0.3	-	0.3		-
			2.3 to <2.7	-	-	0.4	-	0.4		-
		I _{OL} = 12 mA	2.7 to 3.6	-	-	0.4	-	0.4		-
			2.3 to <2.7	-	-	0.6	-	0.6		-
I _{OL} = 18 mA	2.7 to 3.6	-	-	0.4	-	0.4	-			
	2.3 to <2.7	-	-	0.6	-	0.6	-			
I _{OL} = 24 mA	2.7 to 3.6	-	-	0.55	-	0.55	-			
I _{IN}	Input Leakage Current	V _{IN} = 0 V to 3.6 V	0.9 to 3.6	-	-	±0.1	-	±0.5	μA	
I _{OFF}	Power Off Leakage Current	V _{IN} = 0 V to 3.6 V or V _{OUT} = 0 V to 3.6 V	0	-	-	0.5	-	0.5	μA	
I _{CC}	Quiescent Supply Current	V _{IN} = V _{CC} or GND	0.9 to 3.6	-	-	0.9	-	0.9	μA	

Product parametric performance is indicated in the Electrical Characteristics for the listed test conditions, unless otherwise noted. Product performance may not be indicated by the Electrical Characteristics if operated under different conditions.

AC ELECTRICAL CHARACTERISTICS

Symbol	Parameter	Condition	V _{CC} (V)	T _A = 25°C			T _A = -40°C to +85°C		Unit
				Min	Typ	Max	Min	Max	
t _{PLH} , t _{PHL}	Propagation Delay, (S or I ₀ or I ₁) to Z (Figures 3 and 4)	R _L = 1 MΩ, C _L = 15 pF	0.9	-	19.1	-	-	-	ns
		R _L = 2 kΩ, C _L = 15 pF	1.1 to 1.3	-	6.3	15.5	-	18.8	
			1.4 to 1.6	-	3.8	8.5	-	9.5	
			1.65 to 1.95	-	3.1	6.7	-	7.5	
		R _L = 500 Ω, C _L = 30 pF	2.3 to 2.7	-	2.2	4.1	-	4.4	
			2.7 to 3.6	-	1.9	3.4	-	3.6	

Product parametric performance is indicated in the Electrical Characteristics for the listed test conditions, unless otherwise noted. Product performance may not be indicated by the Electrical Characteristics if operated under different conditions.

CAPACITIVE CHARACTERISTICS

Symbol	Parameter	Test Condition	Typical (T _A = 25°C)	Unit
C _{IN}	Input Capacitance	V _{CC} = 0 V	2.0	pF
C _{OUT}	Output Capacitance	V _{CC} = 0 V	4.5	pF
C _{PD}	Power Dissipation Capacitance (Note 5)	f = 10 MHz, V _{CC} = 0.9 to 3.6 V, V _{IN} = 0 V or V _{CC}	10.0	pF

5. C_{PD} is defined as the value of the internal equivalent capacitance which is calculated from the operating current consumption without load. Average operating current can be obtained by the equation I_{CC(OPR)} = C_{PD} • V_{CC} • f_{in} + I_{CC}. C_{PD} is used to determine the no-load dynamic power consumption: P_D = C_{PD} • V_{CC}² • f_{in} + I_{CC} • V_{CC}.

NC7SV157

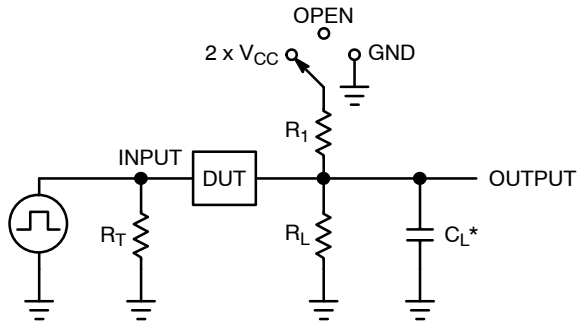

C_L includes probe and jig capacitance
 R_T is Z_{OUT} of pulse generator (typically 50 Ω)
 $f = 1$ MHz

Test	Switch Position
t_{PLH} / t_{PHL}	Open
t_{PLZ} / t_{PZL}	$2 \times V_{CC}$
t_{PHZ} / t_{PZH}	GND

Figure 3. Test Circuit



V_{CC}, V	V_{mi}, V	V_{m0}, V	V_Y, V
0.9	$V_{CC} / 2$	$V_{CC} / 2$	0.1
1.1 to 1.3	$V_{CC} / 2$	$V_{CC} / 2$	0.1
1.4 to 1.6	$V_{CC} / 2$	$V_{CC} / 2$	0.1
1.65 to 1.95	$V_{CC} / 2$	$V_{CC} / 2$	0.15
2.3 to 2.7	$V_{CC} / 2$	$V_{CC} / 2$	0.15
3.0 to 3.6	1.5	1.5	0.3

Figure 4. Switching Waveforms

NC7SV157

ORDERING INFORMATION

Device	Package	Marking	Pin 1 Orientation (See below)	Shipping†
NC7SV157P6X	SC-88A	VF7	Q4	3000 / Tape & Reel
NC7SV157L6X	MicroPak	H9	Q4	5000 / Tape & Reel

†For information on tape and reel specifications, including part orientation and tape sizes, please refer to our Tape and Reel Packaging Specifications Brochure, BRD8011/D.

Pin 1 Orientation in Tape and Reel

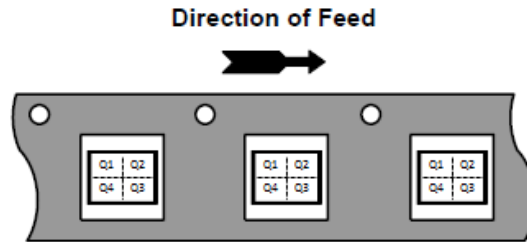

MicroPak is trademark of Semiconductor Components Industries, LLC (SCILLC) or its subsidiaries in the United States and/or other countries.

NC7SV157

PACKAGE DIMENSIONS

SIP6 1.45X1.0
CASE 127EB
ISSUE O

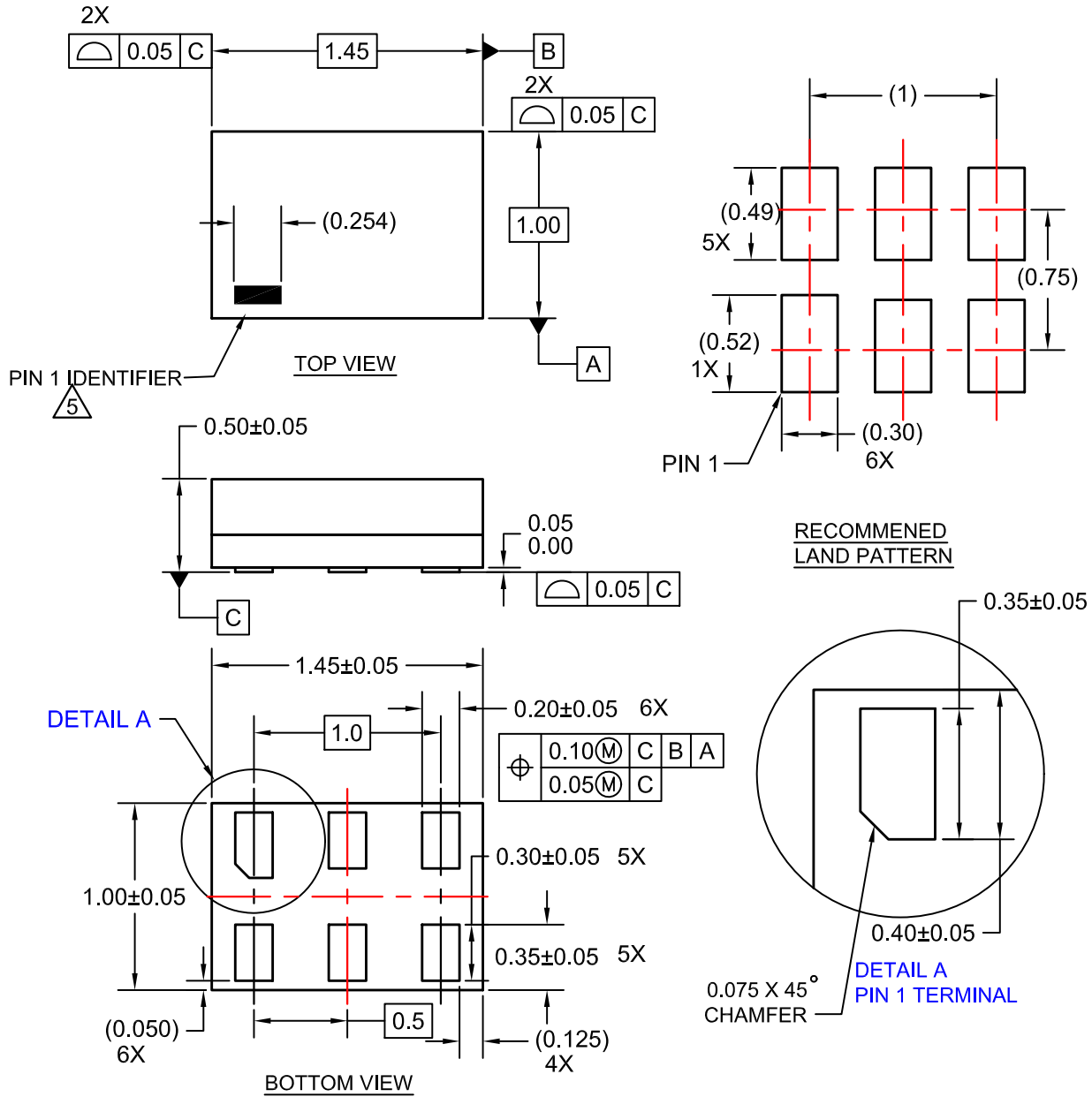

NOTES:

1. CONFORMS TO JEDEC STANDARD MO-252 VARIATION UAAD
2. DIMENSIONS ARE IN MILLIMETERS
3. DRAWING CONFORMS TO ASME Y14.5M-2009
4. PIN ONE IDENTIFIER IS 2X LENGTH OF ANY OTHER LINE IN THE MARK CODE LAYOUT.

NC7SV157

PACKAGE DIMENSIONS

SC-88/SC70-6/SOT-363
CASE 419B-02
ISSUE Y

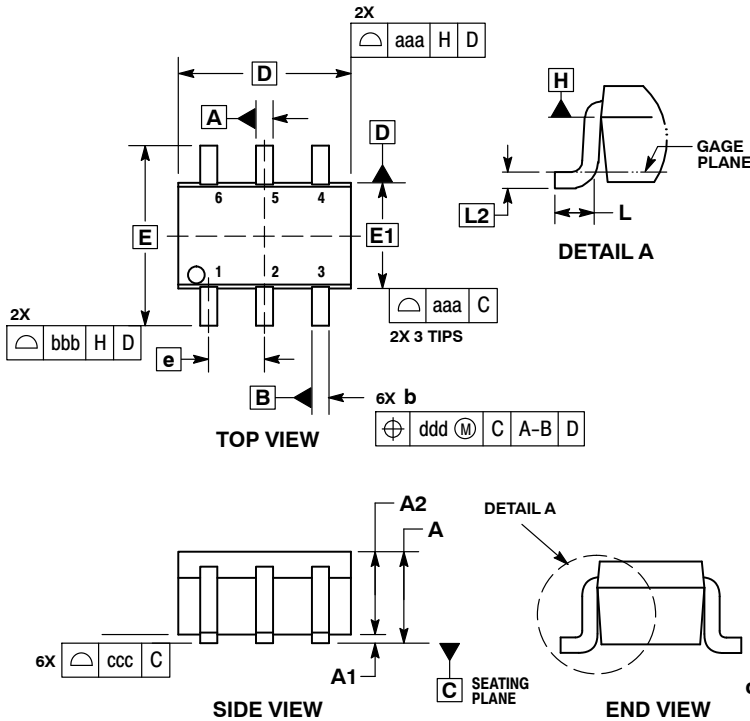

NOTES:

1. DIMENSIONING AND TOLERANCING PER ASME Y14.5M, 1994.
2. CONTROLLING DIMENSION: MILLIMETERS.
3. DIMENSIONS D AND E1 DO NOT INCLUDE MOLD FLASH, PROTRUSIONS, OR GATE BURRS. MOLD FLASH, PROTRUSIONS, OR GATE BURRS SHALL NOT EXCEED 0.20 PER END.
4. DIMENSIONS D AND E1 AT THE OUTERMOST EXTREMES OF THE PLASTIC BODY AND DATUM H.
5. DATUMS A AND B ARE DETERMINED AT DATUM H.
6. DIMENSIONS b AND c APPLY TO THE FLAT SECTION OF THE LEAD BETWEEN 0.08 AND 0.15 FROM THE TIP.
7. DIMENSION b DOES NOT INCLUDE DAMBAR PROTRUSION. ALLOWABLE DAMBAR PROTRUSION SHALL BE 0.08 TOTAL IN EXCESS OF DIMENSION b AT MAXIMUM MATERIAL CONDITION. THE DAMBAR CANNOT BE LOCATED ON THE LOWER RADIUS OF THE FOOT.

DIM	MILLIMETERS			INCHES		
	MIN	NOM	MAX	MIN	NOM	MAX
A	---	---	1.10	---	---	0.043
A1	0.00	---	0.10	0.000	---	0.004
A2	0.70	0.90	1.00	0.027	0.035	0.039
b	0.15	0.20	0.25	0.006	0.008	0.010
C	0.08	0.15	0.22	0.003	0.006	0.009
D	1.80	2.00	2.20	0.070	0.078	0.086
E	2.00	2.10	2.20	0.078	0.082	0.086
E1	1.15	1.25	1.35	0.045	0.049	0.053
e	0.65 BSC			0.026 BSC		
L	0.26	0.36	0.46	0.010	0.014	0.018
L2	0.15 BSC			0.006 BSC		
aaa	0.15			0.006		
bbb	0.30			0.012		
ccc	0.10			0.004		
ddd	0.10			0.004		

RECOMMENDED SOLDERING FOOTPRINT*

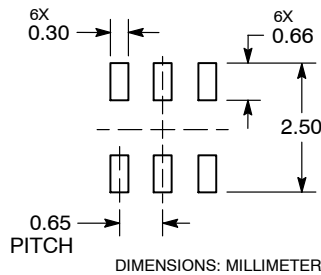

*For additional information on our Pb-Free strategy and soldering details, please download the **onsemi** Soldering and Mounting Techniques Reference Manual, SOLDERRM/D.

onsemi, **Onsemi**, and other names, marks, and brands are registered and/or common law trademarks of Semiconductor Components Industries, LLC dba "onsemi" or its affiliates and/or subsidiaries in the United States and/or other countries. onsemi owns the rights to a number of patents, trademarks, copyrights, trade secrets, and other intellectual property. A listing of onsemi's product/patent coverage may be accessed at www.onsemi.com/site/pdf/Patent-Marketing.pdf. onsemi reserves the right to make changes at any time to any products or information herein, without notice. The information herein is provided "as-is" and onsemi makes no warranty, representation or guarantee regarding the accuracy of the information, product features, availability, functionality, or suitability of its products for any particular purpose, nor does onsemi assume any liability arising out of the application or use of any product or circuit, and specifically disclaims any and all liability, including without limitation special, consequential or incidental damages. Buyer is responsible for its products and applications using onsemi products, including compliance with all laws, regulations and safety requirements or standards, regardless of any support or applications information provided by onsemi. "Typical" parameters which may be provided in onsemi data sheets and/or specifications can and do vary in different applications and actual performance may vary over time. All operating parameters, including "Typicals" must be validated for each customer application by customer's technical experts. onsemi does not convey any license under any of its intellectual property rights nor the rights of others. onsemi products are not designed, intended, or authorized for use as a critical component in life support systems or any FDA Class 3 medical devices or medical devices with a same or similar classification in a foreign jurisdiction or any devices intended for implantation in the human body. Should Buyer purchase or use onsemi products for any such unintended or unauthorized application, Buyer shall indemnify and hold onsemi and its officers, employees, subsidiaries, affiliates, and distributors harmless against all claims, costs, damages, and expenses, and reasonable attorney fees arising out of, directly or indirectly, any claim of personal injury or death associated with such unintended or unauthorized use, even if such claim alleges that onsemi was negligent regarding the design or manufacture of the part. onsemi is an Equal Opportunity/Affirmative Action Employer. This literature is subject to all applicable copyright laws and is not for resale in any manner.

PUBLICATION ORDERING INFORMATION

LITERATURE FULFILLMENT:
Email Requests to: orderlit@onsemi.com

onsemi Website: www.onsemi.com

TECHNICAL SUPPORT
North American Technical Support:
Voice Mail: 1 800-282-9855 Toll Free USA/Canada
Phone: 011 421 33 790 2910

Europe, Middle East and Africa Technical Support:
Phone: 00421 33 790 2910
For additional information, please contact your local Sales Representative