

Cylindrical (Ø18mm) Type

■ Features

- Realizes long sensing distance (20m) (through-beam type)
- Superior noise resistance with digital signal processing
- High-speed response time under 1ms
- Power reverse polarity protection circuit, output short over current protection circuit
- Suitable for sensing in narrow space (narrow beam type)
- External sensitivity adjustment (except through-beam type)
- Light ON, Dark ON switchable by control wire (except through-beam type)
- Excellent environment-resistance performance with glass lens(BR4M)
- Protection structure IP66 (IEC standard)

⚠ Please read "Safety Considerations" in the instruction manual before using.

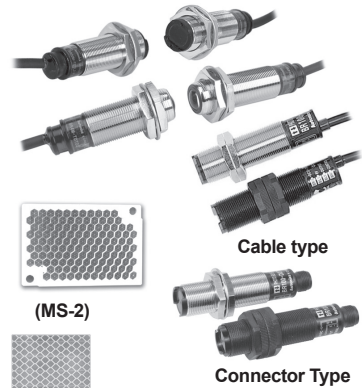

※ The model name with '-C' is connector type.
 ※ MST-□ is sold separately.

■ Specifications

Model	NPN open collector output				PNP open collector output								
	BRP100-DDT	BR100-DDT	BRP400-DDT	BR400-DDT	BRP200-DDTN	BR200-DDTN	BRP3M-MDT	BR3M-MDT	BR4M-TDTD	BR20M-TDTP	BR4M-TDTL	BR20M-TDTL	
	BRP100-DDT-C	BR100-DDT-C	BRP400-DDT-C	BR400-DDT-C	BRP200-DDTN-C	BR200-DDTN-C	BRP3M-MDT-C	BR3M-MDT-C	BR4M-TDTD-C	BR20M-TDTP-C	BR4M-TDTL-C	BR20M-TDTL-C	
	BRP100-DDT-P	BR100-DDT-P	BRP400-DDT-P	BR400-DDT-P	BRP200-DDTN-P	BR200-DDTN-P	BRP3M-MDT-P	BR3M-MDT-P	BR4M-TDTD-P	BR20M-TDTP-P	BR4M-TDTL-P	BR20M-TDTL-P	
	BRP100-DDT-C-P	BR100-DDT-C-P	BRP400-DDT-C-P	BR400-DDT-C-P	BRP200-DDTN-C-P	BR200-DDTN-C-P	BRP3M-MDT-C-P	BR3M-MDT-C-P	BR4M-TDTD-C-P	BR20M-TDTP-C-P	BR4M-TDTL-C-P	BR20M-TDTL-C-P	
Case	Plastic	Metal	Plastic	Metal	Plastic	Metal	Plastic	Metal	Metal				
Sensing type	Diffuse reflective type				Narrow beam reflective type		Retroreflective type		Through-beam type				
Sensing distance	100mm ^{※1}		400mm ^{※2}		200mm ^{※2}		3m ^{※3}		4m	20m	4m	20m	
Sensing target	Opaque, translucent materials						Opaque materials of min. Ø60mm		Opaque materials of min. Ø15mm				
Hysteresis	Max. 20% at rated sensing distance						—		—				
Response time	Max. 1ms												
Power supply	12-24VDC±±10% (ripple P-P: max. 10%)												
Current consumption	Max. 45mA												
Light source	Infrared LED (940nm) Infrared LED (850nm)						Red LED (660nm)		Infrared LED (850nm)				
Sensitivity adjustment	Sensitivity adjuster								Fixed				
Operation mode	Selectable Light ON or Dark ON by control wire (white)								Dark ON		Light ON		
Control output	NPN or PNP open collector output ● Load voltage: max. 30VDC±± ● Load current: max. 200mA ● Residual voltage - NPN: max. 1VDC±±, PNP: max. 2.5VDC												
Protection circuit	Power reverse polarity protection circuit, output short over current protection circuit												
Indicator	Operation indicator: red LED, power indicator: red LED (only for emitter of through-beam type)												
Connection	Cable type, connector type												
Insulation resistance	Over 20MΩ (at 500VDC megger)												
Noise immunity	±240V the square wave noise (pulse width: 1μs) by the noise simulator												
Dielectric strength	1000VAC 50/60Hz for 1 minute												
Vibration	1.5mm amplitude at frequency of 10 to 55Hz (for 1 min) in each X, Y, Z direction for 2 hours												
Shock	500m/s ² (approx. 50G) in each X, Y, Z direction for 3 times												
Environment	Ambient illumination: Sunlight: max. 11,000lx, incandescent lamp: max. 3,000lx (receiver illumination)												
	Ambient temperature: -10 to 60°C, storage: -25 to 75°C												
	Ambient humidity: 35 to 85%RH, storage: 35 to 85%RH												
Protection structure	IP66 (IEC standard) (BR20M Series: IP67)												
Material	● Case - BRP: polyamide (black) BR: brass, ni-plate ● Sensing part - polycarbonate lens						● Case - BRP: polyamide (black) BR: brass, ni-plate ● Sensing part - acrylic lens		● Case - brass, ni-plate ● Sensing part - BR4M: glass lens BR20M: polycarbonate lens				
	Cable type	Ø5mm, 4-wire, 2m (emitter of through-beam type: Ø5mm, 2-wire, 2m / receiver: Ø5mm, 3-wire, 2m) (AWG22, core diameter: 0.08mm, number of cores: 60, insulator out diameter: Ø1.25mm)											
Connector type	M12 connector												
Accessory	Individual	Adjustment screwdriver						Adjustment screwdriver, Reflector (MS-2)		—			
	Common	● BR: M18 fixing nut: 2, washer: 1 ● BRP: M18 fixing nut: 2						● BR: M18 fixing nut: 2, washer: 2 ● BRP: M18 fixing nut: 4					
Approval	CE												
Weight ^{※4}	● BRP: approx. 140g (approx. 100g) ● BRP-C: approx. 70g (approx. 30g)				● BR: approx. 160g (approx. 120g) ● BR-C: approx. 90g (approx. 50g)				● BR: approx. 340g (approx. 300g) ● BR-C: approx. 150g (approx. 110g)				

※1: Non-glossy white paper 50×50mm. ※2: Non-glossy white paper 100×100mm.
 ※3: The sensing distance is specified with using the MS-2 reflector. The distance between the sensor and the reflector should be set over 0.1m. When using reflective tapes, the reflectivity will vary by the size of the tape. Please refer to the catalog or website.
 ※4: The weight includes packaging. The weight in parenthesis is for unit only.
 ※Tightening torque for connector is 0.39 to 0.49N·m.
 ※The temperature or humidity mentioned in Environment indicates a non freezing or condensation.

SENSORS
CONTROLLERS
MOTION DEVICES
SOFTWARE
(A) Photoelectric Sensors
(B) Fiber Optic Sensors
(C) LIDAR
(D) Door/Area Sensors
(E) Vision Sensors
(F) Proximity Sensors
(G) Pressure Sensors
(H) Rotary Encoders
(I) Connectors/ Connector Cables/ Sensor Distribution Boxes/ Sockets

BR Series

Feature Data

Diffuse reflective type / Narrow beam reflective type

●BR100-DDT-□(-P)/BRP100-DDT-□(-P) ●BR400-DDT-□(-P)/BRP400-DDT-□(-P) ●BR200-DDTN-□(-P)/BRP200-DDTN-□(-P)

Sensing area characteristic		Sensing area characteristic		Sensing area characteristic	
Measuring method	Data	Measuring method	Data	Measuring method	Data
<p>Standard sensing target: Non-glossy white paper 50×50mm</p> <p>Diffuse reflective</p>	<p>Sensing distance L (mm)</p> <p>Sensing area ℓ_1 (mm)</p>	<p>Standard sensing target: Non-glossy white paper 50×50mm</p> <p>Diffuse reflective</p>	<p>Sensing distance L (mm)</p> <p>Sensing area ℓ_1 (mm)</p>	<p>Standard sensing target: Non-glossy white paper 50×50mm</p> <p>Diffuse reflective</p>	<p>Sensing distance L (mm)</p> <p>Sensing area ℓ_1 (mm)</p>

Retroreflective type

●BR3M-MDT-□(-P) / BRP3M-MDT-□(-P)

Parallel shifting characteristic		Parallel shifting characteristic		Parallel shifting characteristic	
Measuring method	Data	Measuring method	Data	Measuring method	Data
<p>Reflector (MS-2)</p> <p>Retroreflective</p>	<p>Sensing distance L (m)</p> <p>Sensing area ℓ_1 (mm)</p>	<p>Reflector (MS-2)</p> <p>Retroreflective</p>	<p>Sensing distance L (m)</p> <p>Operation angle θ</p>	<p>Reflector (MS-2)</p> <p>Retroreflective</p>	<p>Sensing distance L (m)</p> <p>Operation angle θ</p>

Through-beam type

●BR4M-TDT□-□ / BR4M-TDT□-□-P

Parallel shifting characteristic		Angle characteristic	
Measuring method	Data	Measuring method	Data
<p>Receiver</p> <p>Emitter</p>	<p>Sensing distance L (m)</p> <p>Sensing area ℓ_1 (mm)</p>	<p>Receiver</p> <p>Emitter</p>	<p>Sensing distance L (m)</p> <p>Operation angle θ</p>

●BR20M-TDT□-□ / BR20M-TDT□-□-P

Parallel shifting characteristic		Angle characteristic	
Measuring method	Data	Measuring method	Data
<p>Receiver</p> <p>Emitter</p>	<p>Sensing distance L (m)</p> <p>Sensing area ℓ_1 (mm)</p>	<p>Receiver</p> <p>Emitter</p>	<p>Sensing distance L (m)</p> <p>Operation angle θ</p>

Cylindrical Type

■ Dimensions

(unit: mm)

○ Diffuse reflective/Narrow beam reflective/Retroreflective type

- BR100-DDT(-P) • BR200-DDTN(-P)
- BR400-DDT(-P)

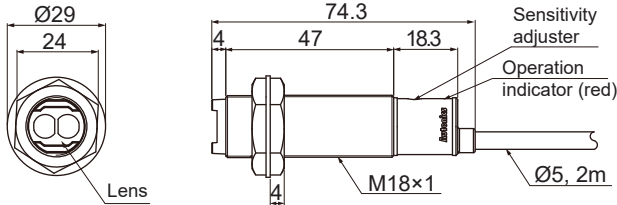

- BR3M-MDT(-P)

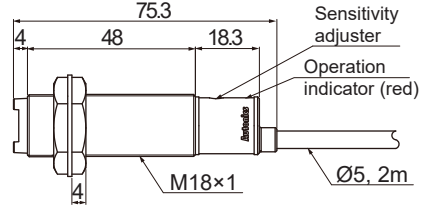

- BR100-DDT-C(-P) • BR200-DDTN-C(-P)
- BR400-DDT-C(-P)

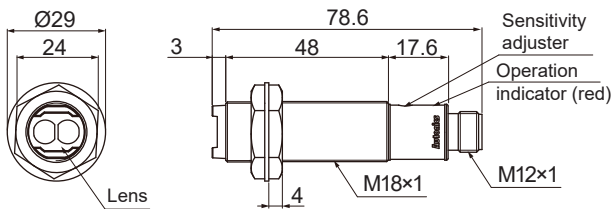

- BR3M-MDT-C(-P)

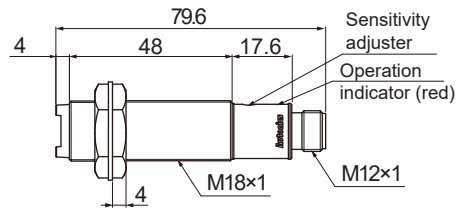

- BRP100-DDT(-P) • BRP200-DDTN(-P)
- BRP400-DDT(-P)

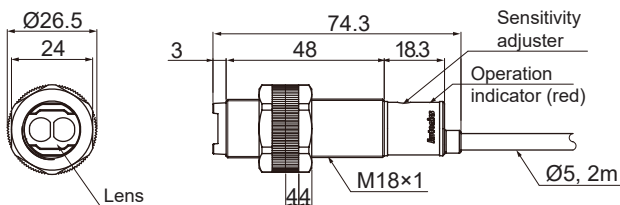

- BRP3M-MDT(-P)

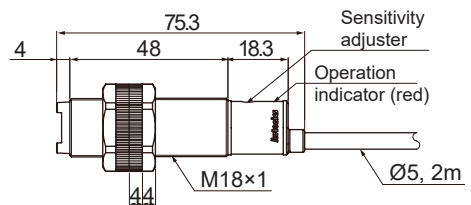

- BRP100-DDT-C(-P) • BRP200-DDTN-C(-P)
- BRP400-DDT-C(-P)

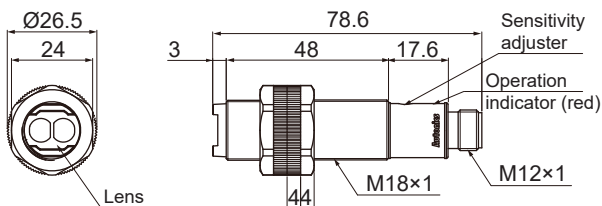

- BRP3M-MDT-C(-P)

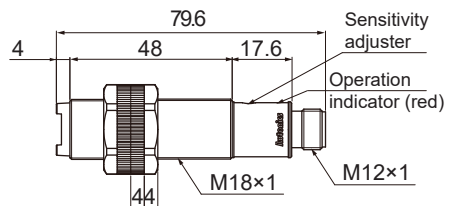

SENSORS

CONTROLLERS

MOTION DEVICES

SOFTWARE

(A) Photoelectric Sensors

(B) Fiber Optic Sensors

(C) LIDAR

(D) Door/Area Sensors

(E) Vision Sensors

(F) Proximity Sensors

(G) Pressure Sensors

(H) Rotary Encoders

(I) Connectors/ Connector Cables/ Sensor Distribution Boxes/ Sockets

BR Series

○ Through-beam type

(unit: mm)

● BR4M-TDTD(-P) / BR4M-TDTL(-P)

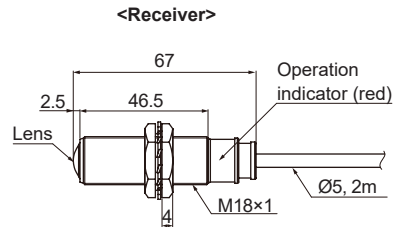
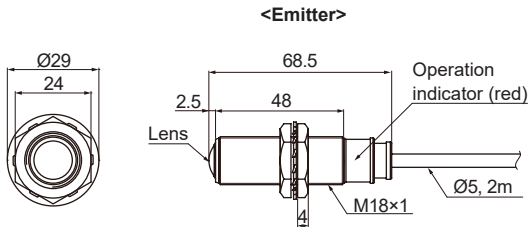

● BR4M-TDTD-C(-P) / BR4M-TDTL-C(-P)

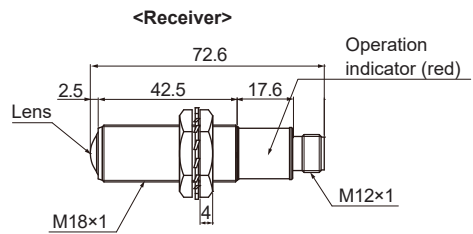
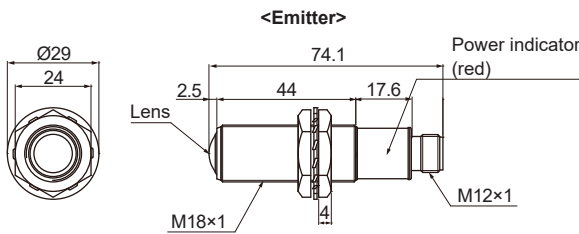

● BR20M-TDTD(-P) / BR20M-TDTL(-P)

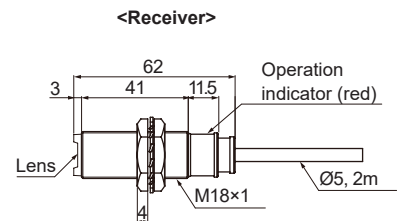
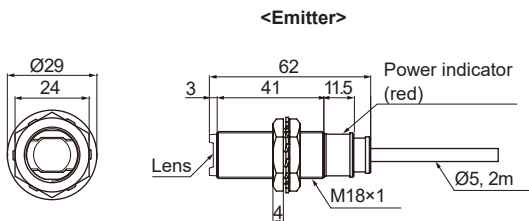

● BR20M-TDTD-C(-P) / BR20M-TDTL-C(-P)

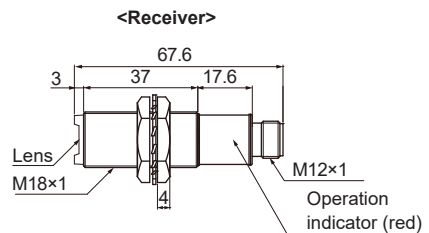
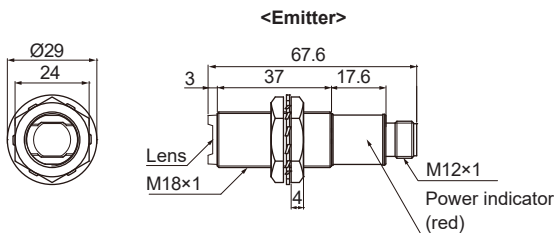

● Connection cable (sold separately)

· CIDH4-□

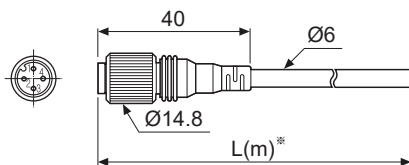

· CLDH4-□

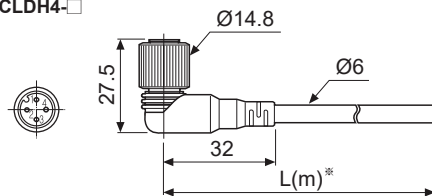

※ Specification of connector cable: Ø6mm, 4-wire, 2m/3m/5m/7m
(AWG22, core diameter: 0.08mm, number of cores: 60, insulator out diameter: Ø1.65mm)

Cylindrical Type

• M18 fixing nut

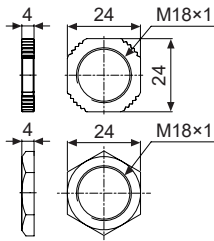

• Reflector

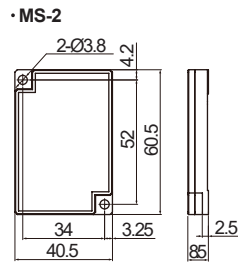

• Reflective tape (sold separately)

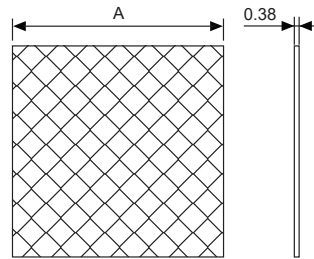

Model	A
MST-50-10	<input type="checkbox"/> 50
MST-100-5	<input type="checkbox"/> 100
MST-200-2	<input type="checkbox"/> 200

■ Operation Mode

Operation mode	Light ON	Dark ON
Receiver operation	Received light Interrupted light	Received light Interrupted light
Operation indicator (red LED)	ON OFF	ON OFF
Transistor output	ON OFF	ON OFF

※The transistor output will be held OFF for 0.5 sec after supplied power in order to prevent malfunction of this photoelectric sensor (except through-beam type).

■ Connections

• Diffuse reflective type / Narrow beam reflective type

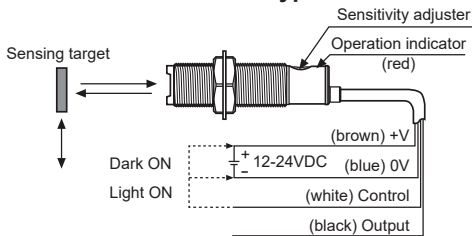

• Retroreflective type

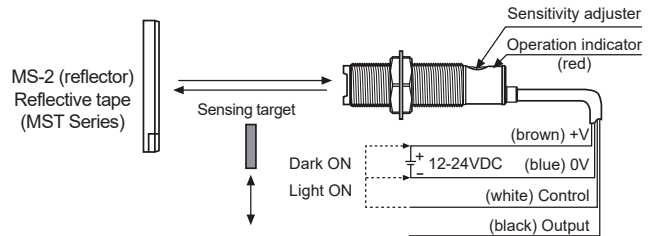

• Through-beam type

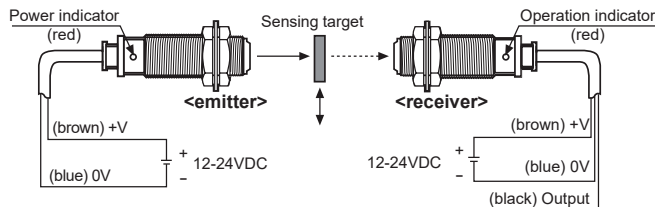

■ Connections for Connector Part

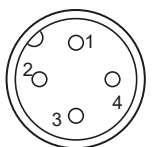

M12 Connector pin

Pin No.	Cable color	Application Diffuse/ Narrow beam reflective/ Retroreflective type	Through-beam type	
			Emitter	Receiver
1	Brown	24VDC	24VDC	24VDC
2	White	CONTROL	N-C	GND
3	Blue	GND	GND	GND
4	Black	OUTPUT	N-C	OUTPUT

• Connector cable (sold separately)

※Please refer to the connector cable section.

SENSORS

CONTROLLERS

MOTION DEVICES

SOFTWARE

(A) Photoelectric Sensors

(B) Fiber Optic Sensors

(C) LIDAR

(D) Door/Area Sensors

(E) Vision Sensors

(F) Proximity Sensors

(G) Pressure Sensors

(H) Rotary Encoders

(I) Connectors/
Connector Cables/
Sensor Distribution
Boxes/ Sockets

Control Output Diagram

• NPN open collector output

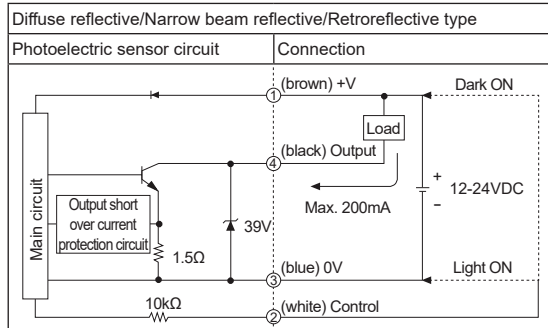
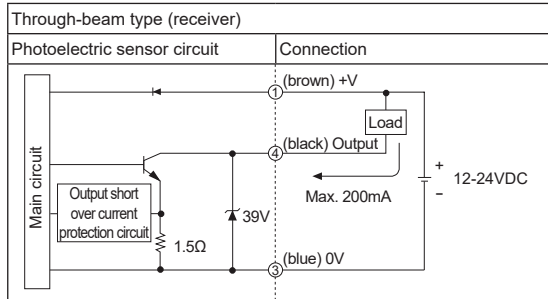

• PNP open collector output

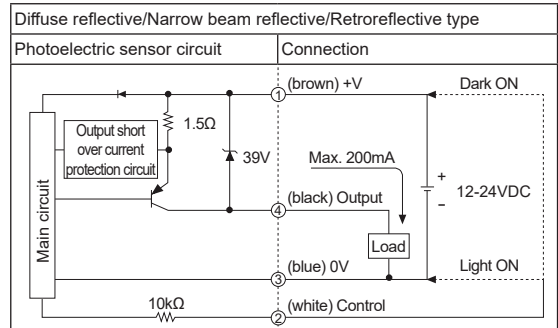
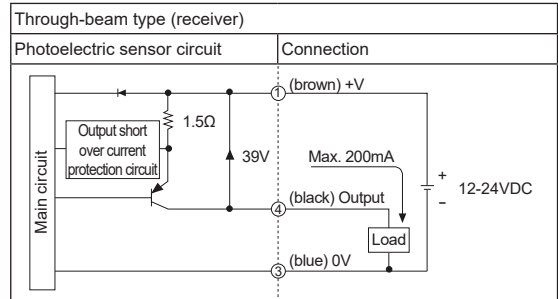

※Before using this unit, select Light ON/Dark ON with control wire. (light on: connect control wire 0V / dark on: connect control wire with +V)

※Control wire is only for Diffuse reflective/Narrow beam reflective/Retroreflective type.

※If short-circuit the control output terminal or supply current over the rated specification, normal control signal is not output due to the output short over current protection circuit.

Installation and Sensitivity Adjustment

Install the sensor to the desired place and check the connections. Supply the power to the sensor and adjust the optical axis and the sensitivity as following.

When using photoelectric sensors closely over two units, it may result in malfunction due to mutual interference.

When installing the product, tighten the screw with a tightening torque of 0.39N·m for BRP and to 14.7N·m for BR.

◎ Diffuse reflective/Narrow beam reflective type

1. The sensitivity should be adjusted depending on a sensing target or mounting place.

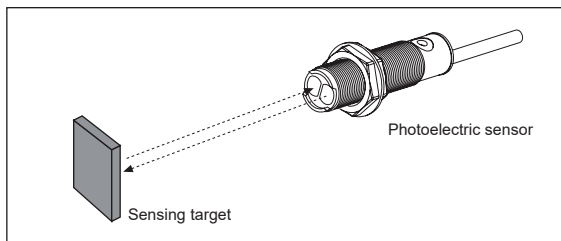

※Be sure that it can be different by size, surface and gloss of target.

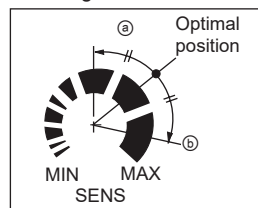

2. Set the target at a position to be detected by the beam, then turn the sensitivity adjuster until position ㊸ where the operation indicator turns ON from min. position of the sensitivity adjuster.
3. Take the target out of the sensing area, then turn the sensitivity adjuster until position ㊹ where the operation indicator turns ON. If the indicator dose not turn ON, max. position is ㊹.
4. Set the sensitivity adjuster at the center of two switching position ㊸, ㊹.

◎ Through-beam type

1. Supply the power to the photoelectric sensor, after setting the emitter and the receiver facing each other.
 2. Set the receiver in center of position in the middle of the operation range of indicator by adjusting the receiver or the emitter right and left, up and down.
 3. After the adjustment, check the stability of operation putting the object at the optical axis.
- ※If the sensing target is translucent body or smaller than $\phi 15$, it can be missed by sensor cause light penetrate it.

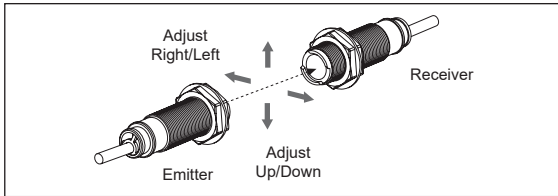

◎ Retroreflective type

1. Supply the power to the photoelectric sensor, after setting the photoelectric sensor and the reflector (MS-2) or reflective tape face to face.
2. Set the photoelectric sensor in the position which indicator turns on, as adjusting the reflector or the sensor right and left, up and down.
3. Fix both units tightly after checking that the unit detects the target.

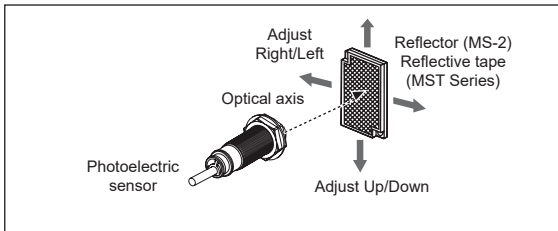

- ※If using more than 2 photoelectric sensors in parallel, the space among them should be more than 30cm.
- ※If reflectance of target is higher than non-glossy white paper, it might cause malfunction by reflection from the target when the target is near to photoelectric sensor. Therefore put enough space between the target and the photoelectric sensor or the surface of the target should be installed at angle of 30 to 45° against optical axis. (when a sensing target with high reflectance near by, photoelectric sensing with the polarizing filter should be used.)

※Sensitivity adjustment: Refer to the diffuse reflective/narrow beam reflective type's.

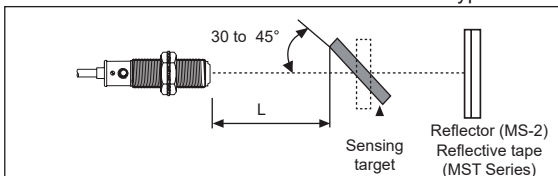

※If the mounting place is too narrow, please use MS-4 instead of MS-2.

※Please use reflective tape (MST Series) for where a reflector is not installed.

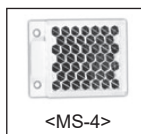

■ Reflectivity by Reflective Tape Model

MST-50-10 (50×50mm)	80%
MST-100-5 (100×100mm)	120%
MST-200-2 (200×200mm)	140%

※This reflectivity is based on the reflector (MS-2).

※Reflectivity may vary depending on usage environment and installation conditions.

The sensing distance and minimum sensing target size increase as the size of the tape increases.

Please check the reflectivity before using reflective tapes.

※For using reflective tape, installation distance should be min. 20mm.

SENSORS

CONTROLLERS

MOTION DEVICES

SOFTWARE

(A) Photoelectric Sensors

(B) Fiber Optic Sensors

(C) LiDAR

(D) Door/Area Sensors

(E) Vision Sensors

(F) Proximity Sensors

(G) Pressure Sensors

(H) Rotary Encoders

(I) Connectors/Connector Cables/Sensor Distribution Boxes/ Sockets