

High voltage power Schottky rectifier

Datasheet - production data

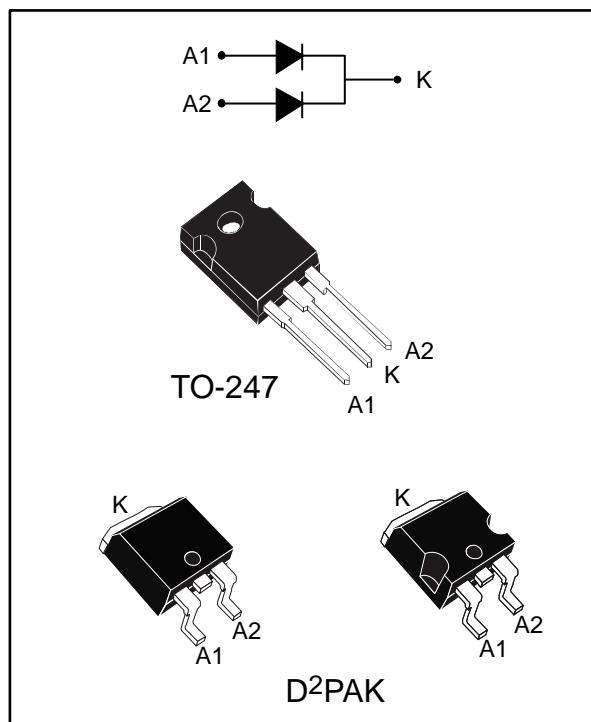

Features

- High junction temperature capability
- Good trade off between leakage current and forward voltage drop
- Low leakage current
- Avalanche capability specified
- ECOPACK®2 compliant component for D²PAK on demand

Description

Dual center tap Schottky rectifier designed for high frequency switch mode power supply.

Table 1: Device summary

| Symbol | Value |
|-------------|----------|
| $I_{F(AV)}$ | 2 x 15 A |
| V_{RRM} | 170 V |
| T_j (max) | 175 °C |
| V_F (typ) | 0.69 V |

1 Characteristics

Table 2: Absolute ratings (limiting values, per diode, at 25 °C, unless otherwise specified)

| Symbol | Parameter | | Value | Unit | |
|---------------------|---|-------------------------------------|-------------|------|---|
| V _{RRM} | Repetitive peak reverse voltage | | 170 | V | |
| I _{F(RMS)} | Forward rms current | | 30 | A | |
| I _{F(AV)} | Average forward current δ = 0.5, square wave | T _C = 150 °C | Per diode | 15 | A |
| | | | Per device | 30 | |
| I _{FSM} | Surge non repetitive forward current | tp = 10 ms sinusoidal | 220 | A | |
| P _{ARM} | Repetitive peak avalanche power | tp = 10 μs, T _j = 125 °C | 750 | W | |
| T _{stg} | Storage temperature range | | -65 to +175 | °C | |
| T _j | Maximum operating junction temperature ⁽¹⁾ | | +175 | °C | |

Notes:

⁽¹⁾(dP_{tot}/dT_j) < (1/R_{th(j-a)}) condition to avoid thermal runaway for a diode on its own heatsink.

Table 3: Thermal parameter

| Symbol | Parameter | | Max. value | Unit | |
|----------------------|------------------|--------------------|------------|------|------|
| R _{th(j-c)} | Junction to case | D ² PAK | Per diode | 1.6 | °C/W |
| | | TO-247 | | 1.5 | |
| | | D ² PAK | Total | 0.95 | |
| | | TO-247 | | 0.9 | |
| R _{th(c)} | Coupling | D ² PAK | Coupling | 0.3 | °C/W |
| | | TO-247 | | | |

When the diodes 1 and 2 are used simultaneously:

$$\Delta T_j (\text{diode1}) = P_{(\text{diode1})} \times R_{th(j-c)} (\text{per diode}) + P_{(\text{diode2})} \times R_{th(c)}$$

Table 4: Static electrical characteristics (per diode)

| Symbol | Parameter | Test conditions | | Min. | Typ. | Max. | Unit |
|-------------|-------------------------|-----------------------|---------------------|------|------|------|---------------|
| $I_R^{(1)}$ | Reverse leakage current | $T_j = 25\text{ °C}$ | $V_R = V_{RRM}$ | - | | 20 | μA |
| | | $T_j = 125\text{ °C}$ | | - | 5 | 20 | mA |
| $V_F^{(2)}$ | Forward voltage drop | $T_j = 25\text{ °C}$ | $I_F = 15\text{ A}$ | - | | 0.92 | V |
| | | $T_j = 125\text{ °C}$ | | - | 0.69 | 0.75 | |
| | | $T_j = 25\text{ °C}$ | $I_F = 30\text{ A}$ | - | | 1 | |
| | | $T_j = 125\text{ °C}$ | | - | 0.8 | 0.86 | |

Notes:

⁽¹⁾Pulse test: $t_p = 5\text{ ms}$, $\delta < 2\%$

⁽²⁾Pulse test: $t_p = 380\text{ }\mu\text{s}$, $\delta < 2\%$

To evaluate the conduction losses use the following equation:

$$P = 0.64 \times I_{F(AV)} + 0.0073 I_{F(RMS)}^2$$

1.1 Characteristics (curves)

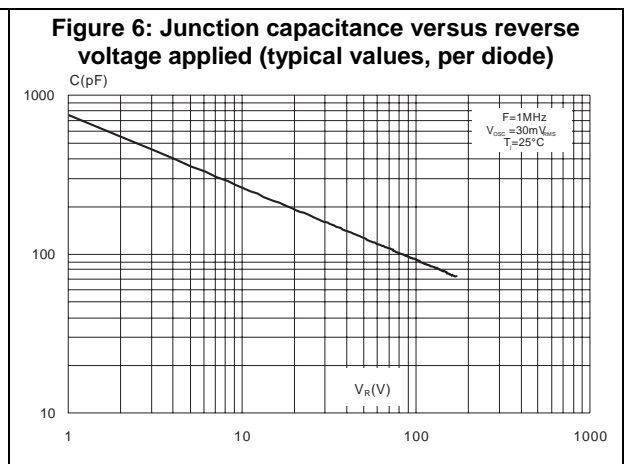
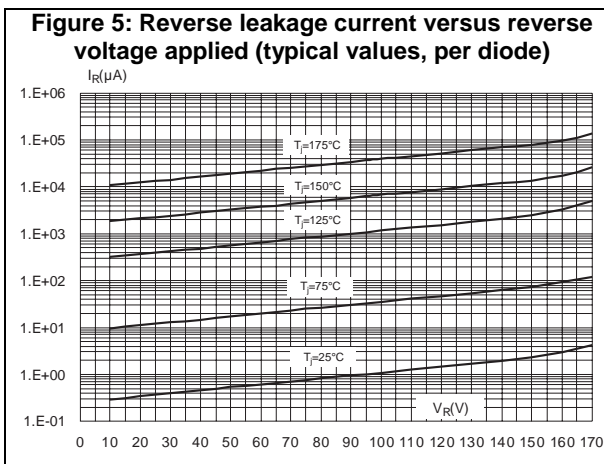
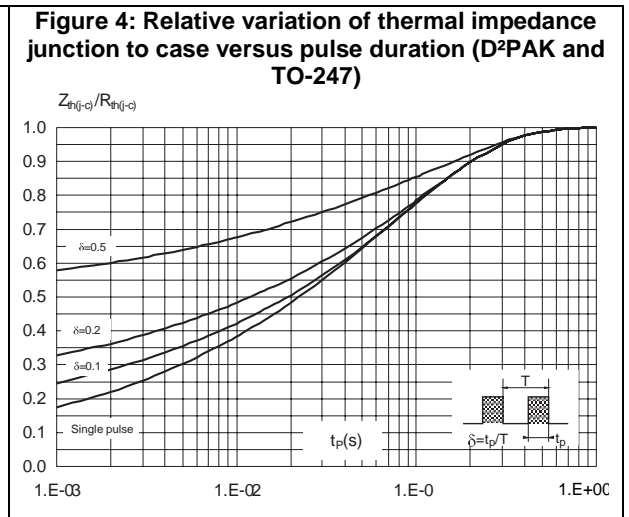
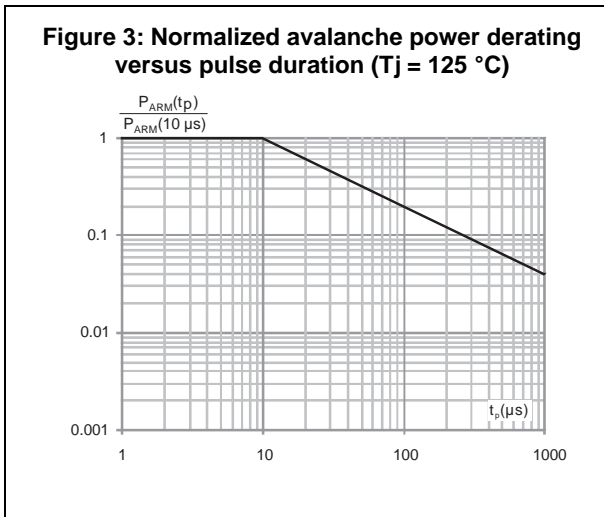
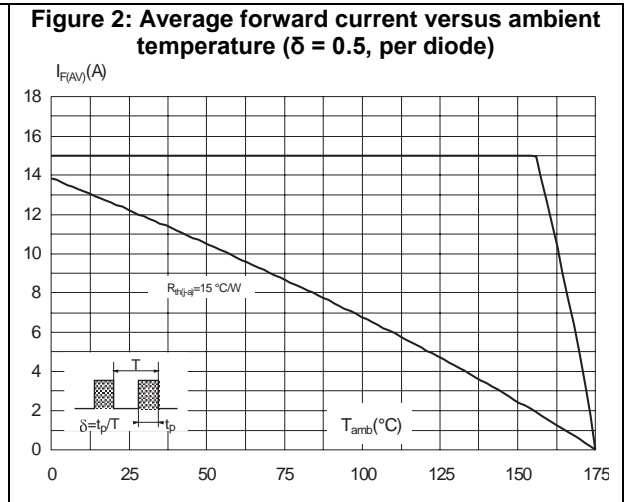
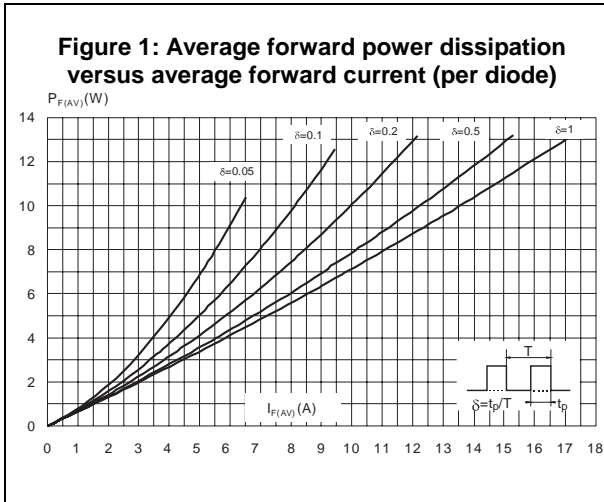

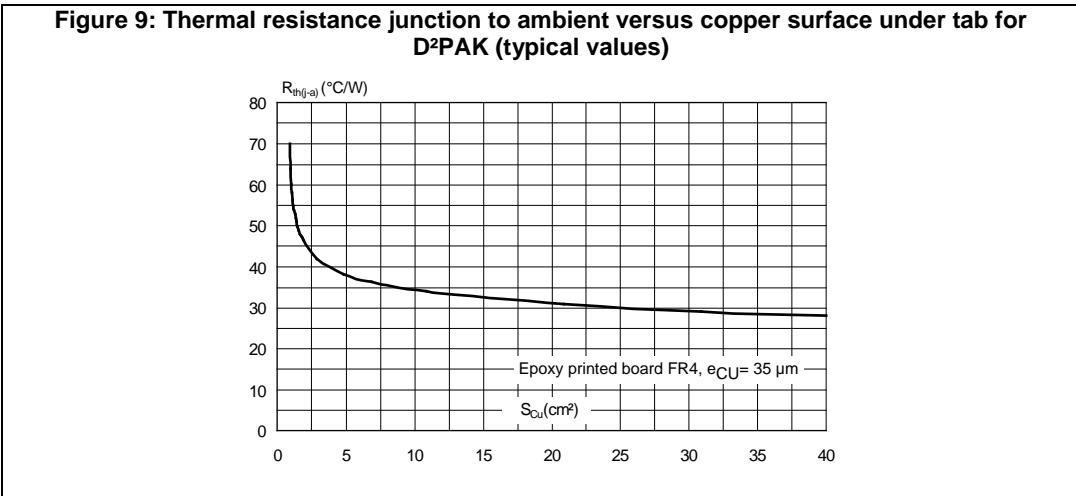
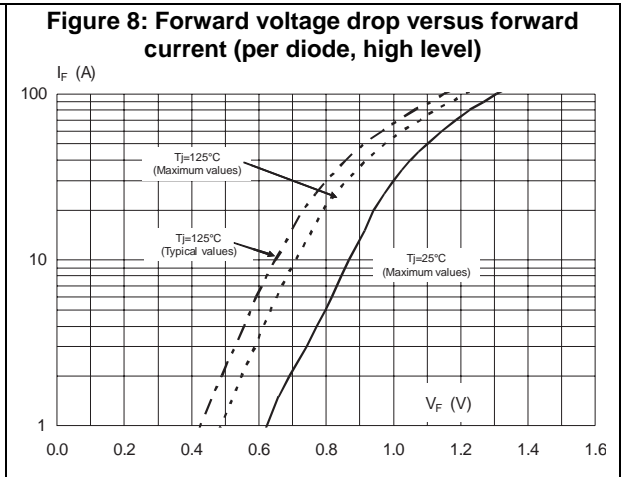
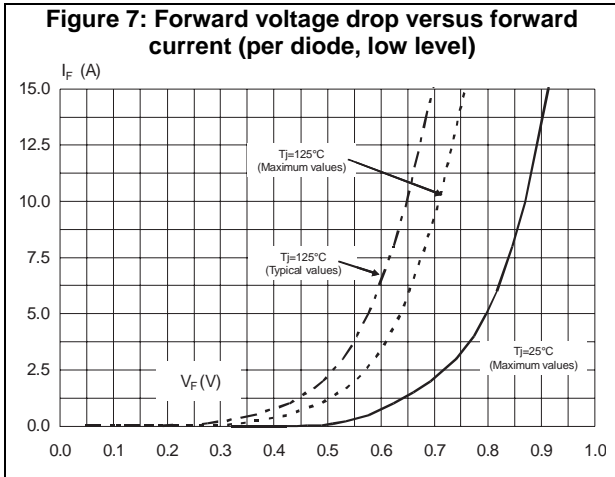

2 Package information

In order to meet environmental requirements, ST offers these devices in different grades of ECOPACK® packages, depending on their level of environmental compliance. ECOPACK® specifications, grade definitions and product status are available at: www.st.com. ECOPACK® is an ST trademark.

- Cooling method: by conduction (C)
- Epoxy meets UL 94,V0
- Recommended torque values: 0.55 N·m (for TO-247)
- Maximum torque values: 1.0 N·m maximum (for TO-247)

2.1 D²PAK package information

Figure 10: D²PAK package outline

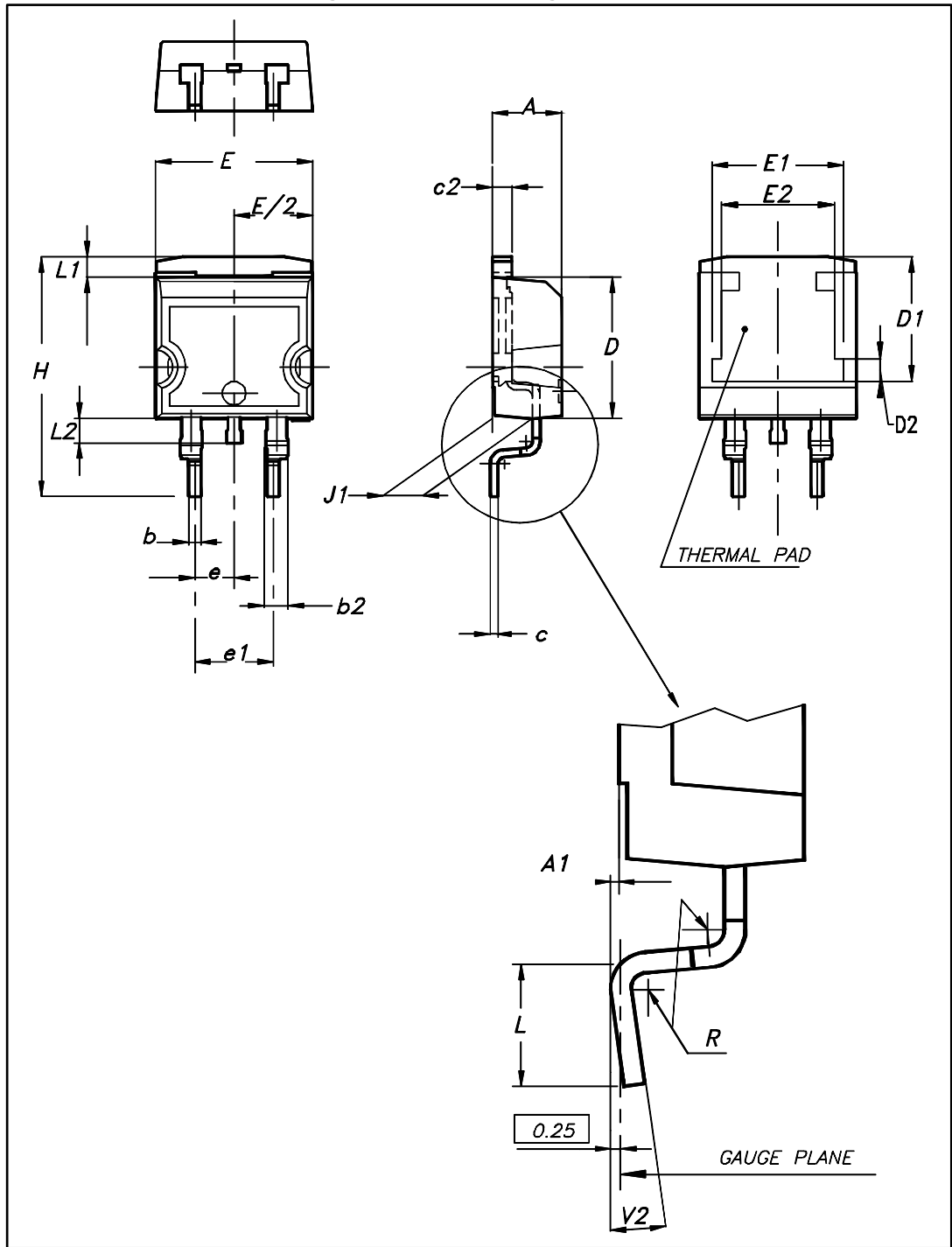

This package drawing may slightly differ from the physical package. However, all the specified dimensions are guaranteed.

Table 5: D²PAK package mechanical data

| Ref. | Dimensions | | | |
|------|-------------|-------|--------|-------|
| | Millimeters | | Inches | |
| | Min. | Max. | Min. | Max. |
| A | 4.36 | 4.60 | 0.172 | 0.181 |
| A1 | 0.00 | 0.25 | 0.000 | 0.010 |
| b | 0.70 | 0.93 | 0.028 | 0.037 |
| b2 | 1.14 | 1.70 | 0.045 | 0.067 |
| c | 0.38 | 0.69 | 0.015 | 0.027 |
| c2 | 1.19 | 1.36 | 0.047 | 0.053 |
| D | 8.60 | 9.35 | 0.339 | 0.368 |
| D1 | 6.90 | 8.00 | 0.272 | 0.311 |
| D2 | 1.10 | 1.50 | 0.043 | 0.060 |
| E | 10.00 | 10.55 | 0.394 | 0.415 |
| E1 | 8.10 | 8.90 | 0.319 | 0.346 |
| E2 | 6.85 | 7.25 | 0.266 | 0.282 |
| e | 2.54 typ. | | 0.100 | |
| e1 | 4.88 | 5.28 | 0.190 | 0.205 |
| H | 15.00 | 15.85 | 0.591 | 0.624 |
| J1 | 2.49 | 2.90 | 0.097 | 0.112 |
| L | 1.90 | 2.79 | 0.075 | 0.110 |
| L1 | 1.27 | 1.65 | 0.049 | 0.065 |
| L2 | 1.30 | 1.78 | 0.050 | 0.070 |
| R | 0.4 typ. | | 0.015 | |
| V2 | 0° | 8° | 0° | 8° |

Figure 11: D²PAK recommended footprint (dimensions in mm)

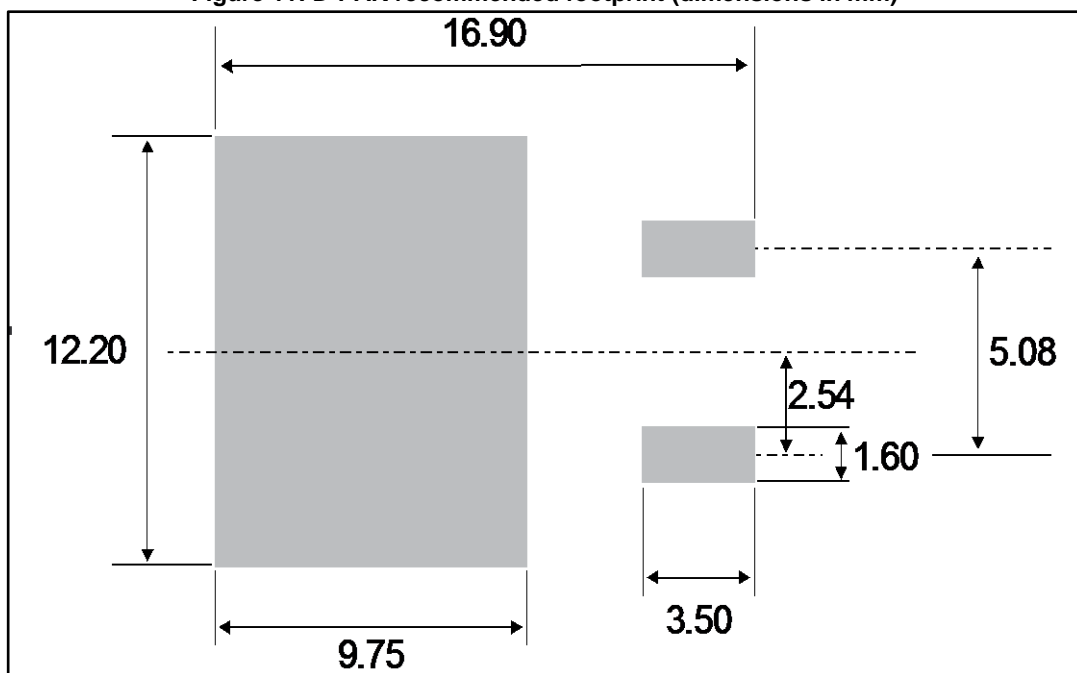

2.2 TO-247 package information

Figure 12: TO-247 package outline

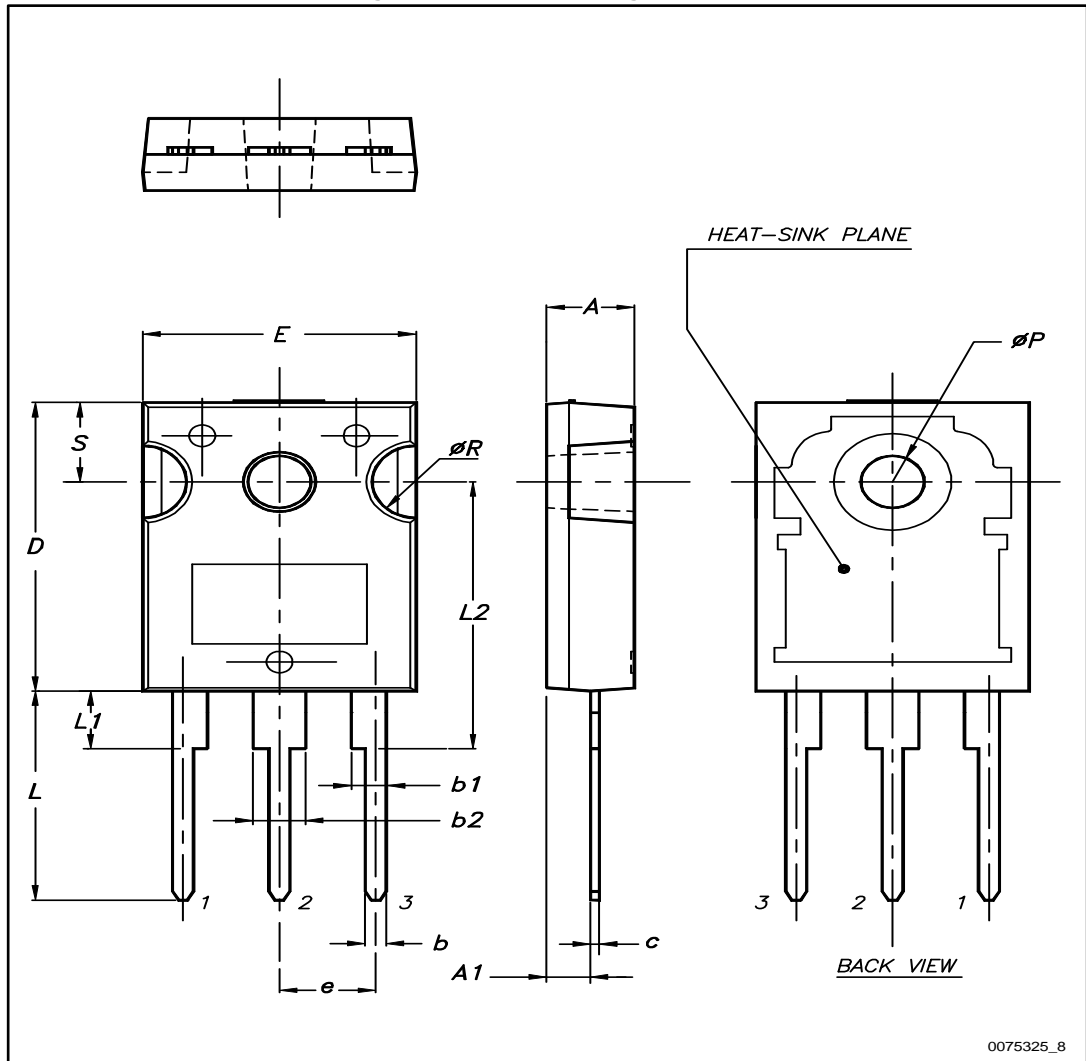

Table 6: TO-247 package mechanical data

| Ref. | Dimensions | | | | | |
|-------------------|-------------|-------|-------|--------|-------|-------|
| | Millimeters | | | Inches | | |
| | Min. | Typ. | Max. | Min. | Typ. | Max. |
| A | 4.85 | | 5.15 | 0.191 | | 0.203 |
| A1 | 2.20 | | 2.60 | 0.086 | | 0.102 |
| b | 1.00 | | 1.40 | 0.039 | | 0.055 |
| b1 | 2.00 | | 2.40 | 0.078 | | 0.094 |
| b2 | 3.00 | | 3.40 | 0.118 | | 0.133 |
| c | 0.40 | | 0.80 | 0.015 | | 0.031 |
| D ⁽¹⁾ | 19.85 | | 20.15 | 0.781 | | 0.793 |
| E | 15.45 | | 15.75 | 0.608 | | 0.620 |
| e | 5.30 | 5.45 | 5.60 | 0.209 | 0.215 | 0.220 |
| L | 14.20 | | 14.80 | 0.559 | | 0.582 |
| L1 | 3.70 | | 4.30 | 0.145 | | 0.169 |
| L2 | | 18.50 | | | 0.728 | |
| ØP ⁽²⁾ | 3.55 | | 3.65 | 0.139 | | 0.143 |
| ØR | 4.50 | | 5.50 | 0.177 | | 0.217 |
| S | 5.30 | 5.50 | 5.70 | 0.209 | 0.216 | 0.224 |

Notes:

⁽¹⁾Dimension D plus gate protusion does not exceed 20.5 mm

⁽²⁾Resin thickness around the mounting hole is not less than 0.9 mm.

3 Ordering information

Table 7: Ordering information

| Order code | Marking | Package | Weight | Base qty | Delivery mode |
|----------------|-------------|--------------------|--------|----------|---------------|
| STPS30170CW | STPS30170CW | TO-247 | 4.40g | 30 | Tube |
| STPS30170CG-TR | STPS30170CG | D ² PAK | 1.48g | 1000 | Tape and reel |

4 Revision history

Table 8: Document revision history

| Date | Revision | Changes |
|-------------|----------|---|
| 16-Sep-2005 | 1 | First issue. |
| 16-May-2017 | 2 | Updated features, package silhouette and Table 1: "Device summary" . Updated Section 1: "Characteristics" , Section 1.1: "Characteristics (curves)" , Section 2: "Package information" and Table 7: "Ordering information" . |

IMPORTANT NOTICE – PLEASE READ CAREFULLY

STMicroelectronics NV and its subsidiaries ("ST") reserve the right to make changes, corrections, enhancements, modifications, and improvements to ST products and/or to this document at any time without notice. Purchasers should obtain the latest relevant information on ST products before placing orders. ST products are sold pursuant to ST's terms and conditions of sale in place at the time of order acknowledgement.

Purchasers are solely responsible for the choice, selection, and use of ST products and ST assumes no liability for application assistance or the design of Purchasers' products.

No license, express or implied, to any intellectual property right is granted by ST herein.

Resale of ST products with provisions different from the information set forth herein shall void any warranty granted by ST for such product.

ST and the ST logo are trademarks of ST. All other product or service names are the property of their respective owners.

Information in this document supersedes and replaces information previously supplied in any prior versions of this document.

© 2017 STMicroelectronics – All rights reserved