

**FEATURES**

**Fixed gain of 15 dB**  
**Operation from 50 MHz to 4.0 GHz**  
**Highest dynamic range gain block**  
**Input/output internally matched to 50  $\Omega$**   
**Integrated bias control circuit**  
**OIP3 of 43.0 dBm at 900 MHz**  
**P1dB of 19.0 dBm at 900 MHz**  
**Noise figure of 3.7 dB at 900 MHz**  
**Single 5 V power supply**  
**Low quiescent current of 83 mA**  
**Thermally efficient SOT-89 package**  
**ESD rating of  $\pm 1.5$  kV (Class 1C)**

**GENERAL DESCRIPTION**

The [ADL5601](#) is a broadband, 15 dB linear amplifier that operates at frequencies up to 4.0 GHz. The device can be used in a wide variety of cellular, cable television (CATV), military, and instrumentation equipment.

The [ADL5601](#) provides the highest dynamic range available from an internally matched gain block. This is accomplished by providing extremely low noise figures and very high OIP3 specifications simultaneously, across the entire 4.0 GHz frequency range.

The [ADL5601](#) provides a gain of 15 dB, which is stable over frequency, temperature, and supply voltage, as well as from device to device. The device is internally matched to 50  $\Omega$  at the input and output, making the [ADL5601](#) very easy to implement in a wide

**FUNCTIONAL BLOCK DIAGRAM**

Figure 1.

variety of applications. Only input/output ac coupling capacitors, power supply decoupling capacitors, and an external inductor are required for operation.

The [ADL5601](#) is fabricated on an InGaP heterojunction bipolar transistor (HBT) process and has an ESD rating of  $\pm 1.5$  kV (Class 1C). The device is available in a thermally efficient SOT-89 package.

The [ADL5601](#) consumes 83 mA on a single 5 V supply and is fully specified for operation from  $-40^{\circ}\text{C}$  to  $+85^{\circ}\text{C}$ .

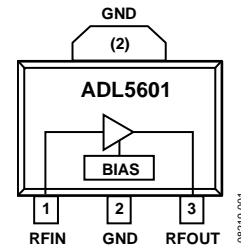
A fully populated RoHS-compliant evaluation board is available.

## TABLE OF CONTENTS

Features .....	1	Basic Connections .....	12
Functional Block Diagram .....	1	Soldering Information and	
General Description .....	1	Recommended PCB Land Pattern .....	12
Revision History .....	2	W-CDMA ACPR Performance .....	13
Specifications.....	3	Evaluation Board .....	14
Typical Scattering Parameters (S-Parameters) .....	5	Outline Dimensions .....	15
Absolute Maximum Ratings.....	7	Ordering Guide .....	15
ESD Caution.....	7		
Pin Configuration and Function Descriptions.....	8		
Typical Performance Characteristics .....	9		

## REVISION HISTORY

### 11/13—Rev. 0 to Rev. A

Added Figure 15, Renumbered Sequentially .....	11
Changes to Figure 17 .....	12
Updated Outline Dimensions .....	15

### 9/09—Revision 0: Initial Version

## SPECIFICATIONS

$V_{CC} = 5\text{ V}$  and  $T_A = 25^\circ\text{C}$ , unless otherwise noted.

Table 1.

Parameter	Test Conditions/Comments	Min	Typ	Max	Unit
OVERALL FUNCTION					
Frequency Range		50		4000	MHz
FREQUENCY = 50 MHz					
Gain			15.6		dB
Output 1 dB Compression Point (P1dB)			16.3		dBm
Output Third-Order Intercept (OIP3)	$\Delta f = 1\text{ MHz}$ , output power ( $P_{OUT}$ ) = 0 dBm per tone		34.0		dBm
Second Harmonic	$P_{OUT} = 0\text{ dBm}$		-50.7		dBc
Third Harmonic	$P_{OUT} = 0\text{ dBm}$		-78.7		dBc
Noise Figure			3.9		dB
FREQUENCY = 140 MHz					
Gain			15.4		dB
vs. Frequency	$\pm 50\text{ MHz}$		$\pm 0.05$		dB
vs. Temperature	$-40^\circ\text{C} \leq T_A \leq +85^\circ\text{C}$		$\pm 0.19$		dB
vs. Supply Voltage	4.75 V to 5.25 V		$\pm 0.02$		dB
Output 1 dB Compression Point (P1dB)			18.8		dBm
Output Third-Order Intercept (OIP3)	$\Delta f = 1\text{ MHz}$ , output power ( $P_{OUT}$ ) = 0 dBm per tone		34.7		dBm
Second Harmonic	$P_{OUT} = 0\text{ dBm}$		-51.1		dBc
Third Harmonic	$P_{OUT} = 0\text{ dBm}$		-77.3		dBc
Noise Figure			3.8		dB
FREQUENCY = 350 MHz					
Gain			15.2		dB
vs. Frequency	$\pm 50\text{ MHz}$		$\pm 0.02$		dB
vs. Temperature	$-40^\circ\text{C} \leq T_A \leq +85^\circ\text{C}$		$\pm 0.20$		dB
vs. Supply Voltage	4.75 V to 5.25 V		$\pm 0.02$		dB
Output 1 dB Compression Point (P1dB)			19.1		dBm
Output Third-Order Intercept (OIP3)	$\Delta f = 1\text{ MHz}$ , output power ( $P_{OUT}$ ) = 0 dBm per tone		35.8		dBm
Second Harmonic	$P_{OUT} = 0\text{ dBm}$		-53.8		dBc
Third Harmonic	$P_{OUT} = 0\text{ dBm}$		-82.9		dBc
Noise Figure			3.8		dB
FREQUENCY = 700 MHz					
Gain		14.3	15.2	16.5	dB
vs. Frequency	$\pm 50\text{ MHz}$		$\pm 0.01$		dB
vs. Temperature	$-40^\circ\text{C} \leq T_A \leq +85^\circ\text{C}$		$\pm 0.21$		dB
vs. Supply Voltage	4.75 V to 5.25 V		$\pm 0.02$		dB
Output 1 dB Compression Point (P1dB)		18.0	19.0		dBm
Output Third-Order Intercept (OIP3)	$\Delta f = 1\text{ MHz}$ , output power ( $P_{OUT}$ ) = 0 dBm per tone		40.7		dBm
Second Harmonic	$P_{OUT} = 0\text{ dBm}$		-55.6		dBc
Third Harmonic	$P_{OUT} = 0\text{ dBm}$		-77.9		dBc
Noise Figure			3.8		dB

Parameter	Test Conditions/Comments	Min	Typ	Max	Unit
FREQUENCY = 900 MHz					
Gain		14.3	15.3	16.5	dB
vs. Frequency	$\pm 50$ MHz		$\pm 0.01$		dB
vs. Temperature	$-40^{\circ}\text{C} \leq T_A \leq +85^{\circ}\text{C}$		$\pm 0.22$		dB
vs. Supply Voltage	4.75 V to 5.25 V		$\pm 0.02$		dB
Output 1 dB Compression Point (P1dB)		18.0	19.0		dBm
Output Third-Order Intercept (OIP3)	$\Delta f = 1$ MHz, output power ( $P_{\text{OUT}}$ ) = 0 dBm per tone		43.0		dBm
Second Harmonic	$P_{\text{OUT}} = 0$ dBm		-57.6		dBc
Third Harmonic	$P_{\text{OUT}} = 0$ dBm		-78.7		dBc
Noise Figure			3.7		dB
FREQUENCY = 2000 MHz					
Gain			14.2		dB
vs. Frequency	$\pm 50$ MHz		$\pm 0.08$		dB
vs. Temperature	$-40^{\circ}\text{C} \leq T_A \leq +85^{\circ}\text{C}$		$\pm 0.27$		dB
vs. Supply Voltage	4.75 V to 5.25 V		$\pm 0.03$		dB
Output 1 dB Compression Point (P1dB)			17.5		dBm
Output Third-Order Intercept (OIP3)	$\Delta f = 1$ MHz, output power ( $P_{\text{OUT}}$ ) = 0 dBm per tone		34.2		dBm
Second Harmonic	$P_{\text{OUT}} = 0$ dBm		-41.9		dBc
Third Harmonic	$P_{\text{OUT}} = 0$ dBm		-67.3		dBc
Noise Figure			4.5		dB
FREQUENCY = 2600 MHz					
Gain			13.4		dB
vs. Frequency	$\pm 50$ MHz		$\pm 0.04$		dB
vs. Temperature	$-40^{\circ}\text{C} \leq T_A \leq +85^{\circ}\text{C}$		$\pm 0.20$		dB
vs. Supply Voltage	4.75 V to 5.25 V		$\pm 0.04$		dB
Output 1 dB Compression Point (P1dB)			16.0		dBm
Output Third-Order Intercept (OIP3)	$\Delta f = 1$ MHz, output power ( $P_{\text{OUT}}$ ) = 0 dBm per tone		30.7		dBm
Second Harmonic	$P_{\text{OUT}} = 0$ dBm		-46.4		dBc
Third Harmonic	$P_{\text{OUT}} = 0$ dBm		-65.4		dBc
Noise Figure			4.7		dB
FREQUENCY = 3500 MHz					
Gain			12.9		dB
vs. Frequency	$\pm 50$ MHz		$\pm 0.06$		dB
vs. Temperature	$-40^{\circ}\text{C} \leq T_A \leq +85^{\circ}\text{C}$		$\pm 0.32$		dB
vs. Supply Voltage	4.75 V to 5.25 V		$\pm 0.05$		dB
Output 1 dB Compression Point (P1dB)			14.2		dBm
Output Third-Order Intercept (OIP3)	$\Delta f = 1$ MHz, output power ( $P_{\text{OUT}}$ ) = 0 dBm per tone		26.7		dBm
Second Harmonic	$P_{\text{OUT}} = 0$ dBm		-41.0		dBc
Third Harmonic	$P_{\text{OUT}} = 0$ dBm		-62.4		dBc
Noise Figure			5.5		dB
FREQUENCY = 4000 MHz					
Gain			12.1		dB
vs. Frequency	$\pm 50$ MHz		$\pm 0.11$		dB
vs. Temperature	$-40^{\circ}\text{C} \leq T_A \leq +85^{\circ}\text{C}$		$\pm 0.50$		dB
vs. Supply Voltage	4.75 V to 5.25 V		$\pm 0.05$		dB
Output 1 dB Compression Point (P1dB)			12.7		dBm
Output Third-Order Intercept (OIP3)	$\Delta f = 1$ MHz, output power ( $P_{\text{OUT}}$ ) = 0 dBm per tone		24.7		dBm
Second Harmonic	$P_{\text{OUT}} = 0$ dBm		-41.0		dBc
Third Harmonic	$P_{\text{OUT}} = 0$ dBm		-59.7		dBc
Noise Figure			6.1		dB

Parameter	Test Conditions/Comments	Min	Typ	Max	Unit
POWER INTERFACE	VCC				
Supply Voltage (V <sub>CC</sub> )		4.5	5.0	5.5	V
Supply Current vs. Temperature	-40°C ≤ T <sub>A</sub> ≤ +85°C		83	100	mA
Power Dissipation	V <sub>CC</sub> = 5 V		±2.3		mA
			0.42		W

**TYPICAL SCATTERING PARAMETERS (S-PARAMETERS)**

V<sub>CC</sub> = 5 V, T<sub>A</sub> = 25°C, and the effects of the evaluation board have been deembedded up to the pins of the device.

Table 2.

Frequency (MHz)	S11		S21		S12		S22	
	Magnitude (dB)	Angle (°)	Magnitude (dB)	Angle (°)	Magnitude (dB)	Angle (°)	Magnitude (dB)	Angle (°)
50	-20.65	-144.57	+15.59	+161.69	-19.76	-7.97	-16.61	-168.75
100	-25.05	+175.09	+15.34	+149.77	-19.85	-24.47	-16.06	+164.97
150	-25.57	+149.73	+15.27	+136.48	-19.89	-38.84	-15.85	+145.84
200	-24.93	+130.36	+15.20	+122.75	-19.92	-52.66	-15.63	+128.22
250	-24.24	+114.36	+15.14	+108.91	-19.96	-66.22	-15.49	+112.53
300	-23.29	+101.24	+15.07	+95.06	-19.99	-79.64	-15.40	+98.52
350	-22.53	+88.38	+15.02	+81.26	-20.03	-92.91	-15.35	+84.79
400	-22.07	+76.45	+14.97	+67.39	-20.05	-106.12	-15.38	+71.26
450	-21.78	+66.13	+14.94	+53.57	-20.07	-119.35	-15.48	+58.84
500	-21.51	+55.91	+14.92	+39.81	-20.08	-132.53	-15.68	+46.57
550	-21.57	+46.37	+14.90	+25.97	-20.09	-145.77	-16.07	+34.25
600	-21.78	+38.11	+14.89	+12.17	-20.10	-159.04	-16.65	+22.42
650	-22.13	+30.61	+14.89	-1.54	-20.10	-172.37	-17.41	+10.91
700	-22.68	+23.62	+14.88	-15.54	-20.11	+174.38	-18.36	-0.29
750	-23.43	+18.47	+14.89	-29.41	-20.11	+161.06	-19.65	-10.39
800	-24.35	+16.37	+14.89	-43.49	-20.11	+147.71	-21.34	-18.60
850	-25.29	+16.28	+14.89	-57.51	-20.12	+134.31	-23.41	-25.16
900	-25.88	+20.10	+14.88	-71.67	-20.13	+120.86	-25.86	-26.32
950	-25.90	+25.78	+14.87	-85.39	-20.14	+107.34	-28.12	-18.10
1000	-25.31	+29.70	+14.87	-99.48	-20.16	+93.84	-28.73	-1.68
1050	-24.16	+29.42	+14.86	-113.64	-20.18	+80.32	-27.11	+8.91
1100	-23.38	+25.45	+14.83	-127.83	-20.22	+66.77	-25.16	+5.98
1150	-22.70	+20.88	+14.81	-141.81	-20.25	+53.39	-23.33	+1.75
1200	-22.10	+13.43	+14.80	-155.93	-20.27	+39.79	-22.27	-8.80
1250	-21.81	+4.90	+14.78	-170.15	-20.31	+26.19	-21.38	-21.30
1300	-21.78	-4.74	+14.75	+175.70	-20.35	+12.56	-20.75	-35.07
1350	-21.96	-15.31	+14.72	+161.57	-20.40	-1.10	-20.35	-50.07
1400	-22.31	-27.46	+14.68	+147.40	-20.44	-14.74	-20.06	-66.34
1450	-22.92	-40.13	+14.64	+133.17	-20.50	-28.45	-19.80	-83.25
1500	-23.53	-55.61	+14.60	+118.79	-20.56	-42.17	-19.60	-100.18
1550	-24.04	-74.40	+14.56	+104.52	-20.62	-55.96	-19.29	-117.80
1600	-24.50	-95.46	+14.49	+90.23	-20.70	-69.82	-18.83	-135.14
1650	-24.13	-118.14	+14.43	+75.97	-20.79	-83.66	-18.22	-150.53
1700	-23.01	-140.97	+14.37	+61.50	-20.89	-97.51	-17.57	-164.65
1750	-21.46	-161.36	+14.27	+47.04	-21.00	-111.39	-16.78	-177.64
1800	-19.67	-178.55	+14.18	+32.52	-21.12	-125.37	-15.91	+170.73
1850	-17.73	+167.17	+14.07	+18.07	-21.26	-139.35	-14.91	+160.24
1900	-15.95	+154.24	+13.92	+3.63	-21.42	-153.36	-13.88	+150.20
1950	-14.26	+141.96	+13.77	-10.89	-21.60	-167.35	-12.82	+140.45
2000	-12.72	+130.33	+13.60	-25.40	-21.81	+178.67	-11.79	+130.63
2050	-11.36	+119.00	+13.39	-39.85	-22.05	+164.79	-10.77	+120.32

Frequency (MHz)	S11		S21		S12		S22	
	Magnitude (dB)	Angle (°)	Magnitude (dB)	Angle (°)	Magnitude (dB)	Angle (°)	Magnitude (dB)	Angle (°)
2100	-10.11	+107.84	+13.16	-54.15	-22.31	+150.95	-9.78	+109.99
2150	-9.04	+96.61	+12.90	-68.23	-22.60	+137.28	-8.88	+99.58
2200	-8.12	+85.63	+12.63	-82.16	-22.91	+123.82	-8.12	+88.80
2250	-7.33	+74.68	+12.34	-95.90	-23.24	+110.57	-7.45	+77.69
2300	-6.66	+63.86	+12.04	-109.35	-23.59	+97.61	-6.85	+66.77
2350	-6.11	+53.33	+11.75	-122.46	-23.92	+84.90	-6.37	+55.88
2400	-5.65	+42.82	+11.46	-135.36	-24.25	+72.46	-6.00	+44.86
2450	-5.28	+32.51	+11.18	-147.97	-24.57	+60.24	-5.68	+33.86
2500	-5.00	+22.51	+10.94	-160.34	-24.86	+48.34	-5.44	+23.12
2550	-4.78	+12.49	+10.73	-172.61	-25.12	+36.64	-5.29	+12.46
2600	-4.64	+2.62	+10.56	+175.37	-25.33	+25.08	-5.19	+1.65
2650	-4.54	-7.06	+10.43	+163.51	-25.52	+13.55	-5.13	-9.06
2700	-4.50	-16.80	+10.35	+151.65	-25.66	+2.20	-5.13	-19.67
2750	-4.52	-26.55	+10.31	+139.80	-25.74	-9.14	-5.19	-30.41
2800	-4.60	-36.24	+10.32	+127.87	-25.78	-20.59	-5.27	-41.23
2850	-4.72	-46.09	+10.37	+115.83	-25.79	-32.13	-5.40	-52.01
2900	-4.92	-56.14	+10.47	+103.58	-25.75	-43.77	-5.60	-62.93
2950	-5.18	-66.18	+10.60	+91.16	-25.67	-55.71	-5.86	-74.10
3000	-5.52	-76.58	+10.76	+78.44	-25.57	-67.81	-6.16	-85.27
3050	-5.95	-87.31	+10.96	+65.65	-25.45	-80.30	-6.57	-96.63
3100	-6.50	-98.20	+11.16	+52.38	-25.30	-93.05	-7.07	-108.36
3150	-7.17	-109.56	+11.37	+38.77	-25.16	-106.14	-7.65	-120.33
3200	-7.96	-121.53	+11.59	+24.80	-25.03	-119.49	-8.35	-132.41
3250	-8.95	-134.08	+11.77	+10.48	-24.91	-133.23	-9.19	-144.97
3300	-10.11	-147.58	+11.94	-4.10	-24.71	-148.47	-10.19	-157.59
3350	-11.43	-162.30	+12.09	-18.93	-24.64	-162.78	-11.23	-171.07
3400	-12.93	-178.72	+12.18	-34.00	-24.61	-177.32	-12.44	+174.45
3450	-14.51	+161.78	+12.24	-49.17	-24.63	+168.07	-13.64	+158.38
3500	-15.96	+138.82	+12.26	-64.42	-24.69	+153.27	-14.74	+140.90
3550	-16.86	+111.84	+12.24	-79.75	-24.80	+138.48	-15.67	+121.24
3600	-16.83	+83.89	+12.17	-95.04	-24.97	+123.67	-16.20	+98.98
3650	-15.98	+58.24	+12.06	-110.33	-25.15	+108.97	-15.98	+76.14
3700	-14.75	+36.92	+11.92	-125.55	-25.39	+94.34	-15.33	+55.10
3750	-13.43	+18.94	+11.76	-140.74	-25.66	+79.90	-14.38	+35.05
3800	-12.23	+3.37	+11.54	-155.80	-25.97	+65.42	-13.18	+17.14
3850	-11.21	-10.83	+11.31	-170.64	-26.33	+51.35	-12.03	+1.60
3900	-10.32	-24.29	+11.05	+174.74	-26.71	+37.49	-11.04	-12.99
3950	-9.59	-37.18	+10.78	+160.27	-27.07	+23.89	-10.13	-27.31
4000	-8.99	-49.64	+10.49	+146.04	-27.43	+10.62	-9.28	-40.73

## ABSOLUTE MAXIMUM RATINGS

Table 3.

Parameter	Rating
Supply Voltage, $V_{CC}$	6.5 V
Input Power (Referred to 50 $\Omega$ )	16 dBm
Internal Power Dissipation (Paddle Soldered)	600 mW
$\theta_{JA}$ (Junction to Air)	30.7°C/W
$\theta_{JC}$ (Junction to Paddle)	5.0°C/W
Maximum Junction Temperature	150°C
Lead Temperature (Soldering, 60 sec)	240°C
Operating Temperature Range	-40°C to +85°C
Storage Temperature Range	-65°C to +150°C

Stresses above those listed under Absolute Maximum Ratings may cause permanent damage to the device. This is a stress rating only; functional operation of the device at these or any other conditions above those indicated in the operational section of this specification is not implied. Exposure to absolute maximum rating conditions for extended periods may affect device reliability.

### ESD CAUTION



**ESD (electrostatic discharge) sensitive device.** Charged devices and circuit boards can discharge without detection. Although this product features patented or proprietary protection circuitry, damage may occur on devices subjected to high energy ESD. Therefore, proper ESD precautions should be taken to avoid performance degradation or loss of functionality.

## PIN CONFIGURATION AND FUNCTION DESCRIPTIONS

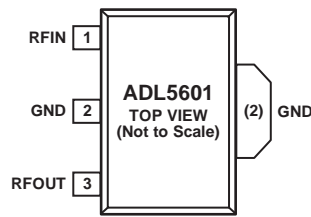

NOTES  
 1. THE EXPOSED PADDLE IS INTERNALLY CONNECTED TO GND AND MUST BE SOLDERED TO A LOW IMPEDANCE GROUND PLANE.

Figure 2. Pin Configuration

Table 4. Pin Function Descriptions

Pin No.	Mnemonic	Description
1	RFIN	RF Input. This pin requires a dc blocking capacitor.
2	GND	Ground. Connect this pin to a low impedance ground plane.
3	RFOUT	RF Output and Supply Voltage. A dc bias is provided to this pin through an inductor that is connected to the external power supply. The RF path requires a dc blocking capacitor.
(2)	Exposed Paddle	Exposed Paddle. The exposed paddle is internally connected to GND and must be soldered to a low impedance ground plane.



# TYPICAL PERFORMANCE CHARACTERISTICS

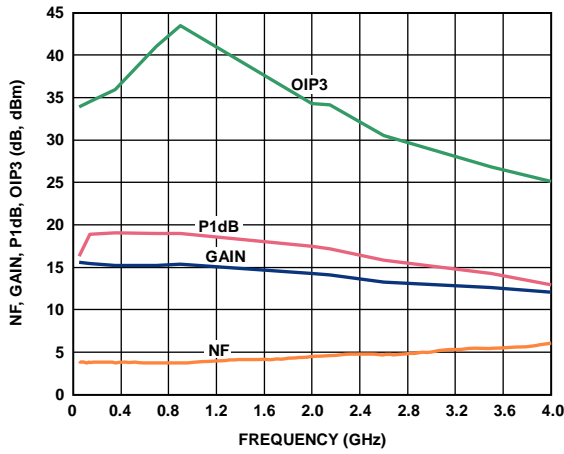

Figure 3. Noise Figure, Gain, P1dB, and OIP3 vs. Frequency

08219-020

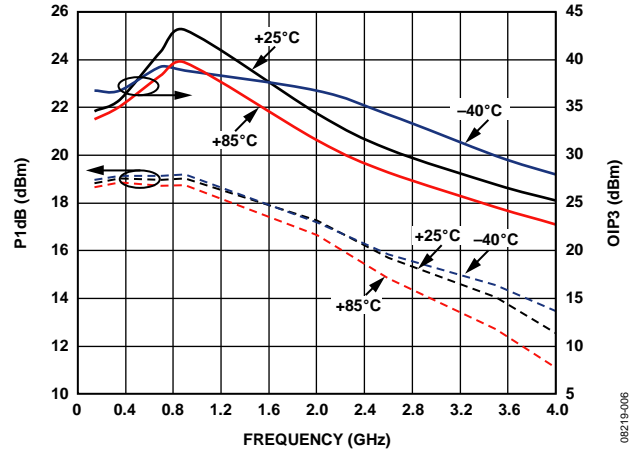

Figure 6. P1dB and OIP3 vs. Frequency and Temperature

08219-006

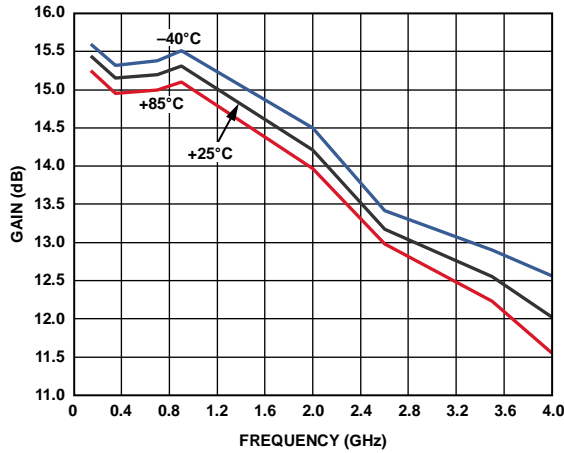

Figure 4. Gain vs. Frequency and Temperature

08219-004

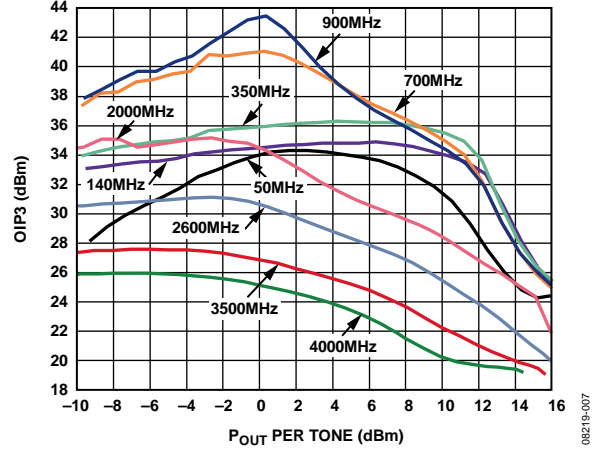

Figure 7. OIP3 vs. Output Power ( $P_{OUT}$ ) and Frequency

08219-007

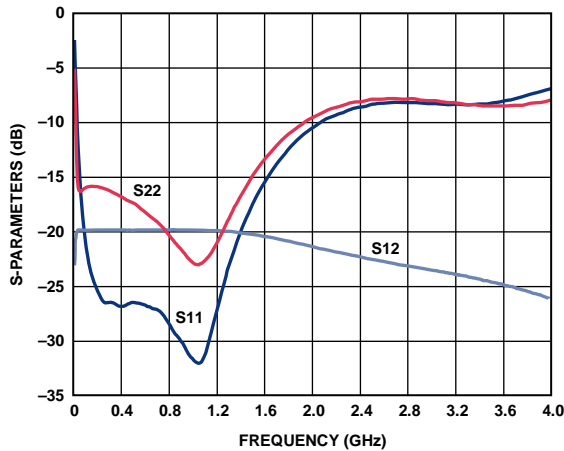

Figure 5. Input Return Loss ( $S_{11}$ ), Output Return Loss ( $S_{22}$ ), and Reverse Isolation ( $S_{12}$ ) vs. Frequency

08219-021

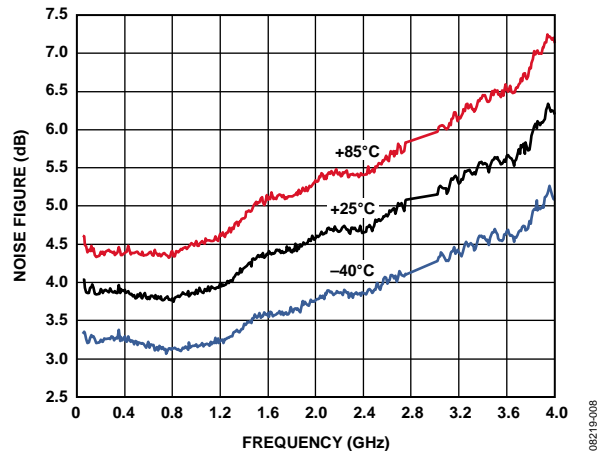

Figure 8. Noise Figure vs. Frequency and Temperature

08219-008

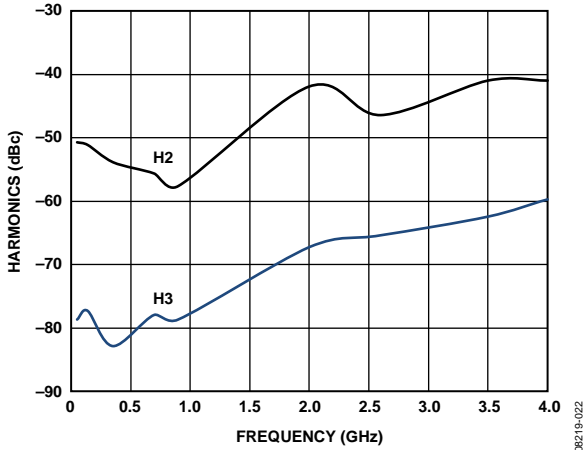

Figure 9. Single-Tone Harmonics vs. Frequency,  $P_{OUT} = 0$  dBm

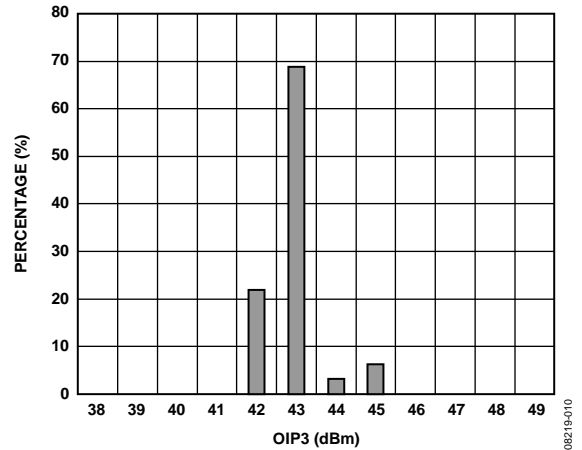

Figure 12. OIP3 Distribution at 900 MHz,  $P_{OUT} = 0$  dBm

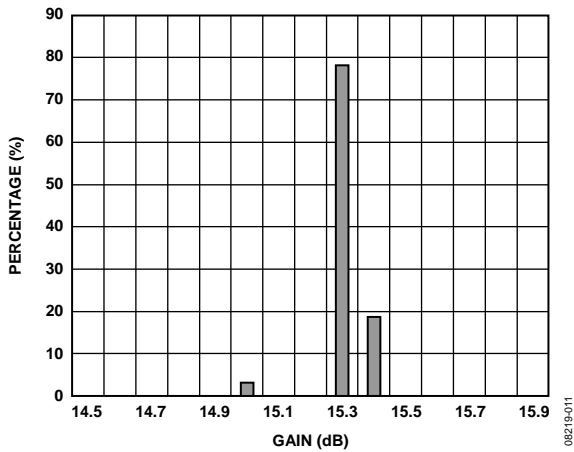

Figure 10. Gain Distribution at 900 MHz

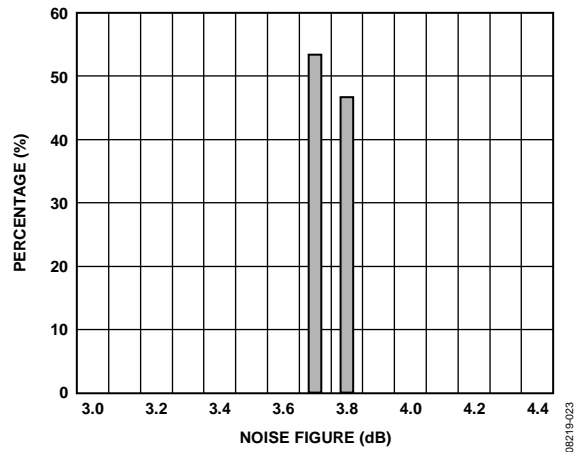

Figure 13. Noise Figure Distribution at 900 MHz

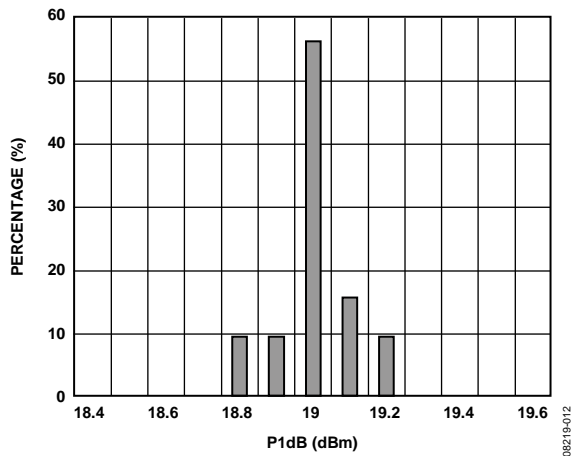

Figure 11. P1dB Distribution at 900 MHz

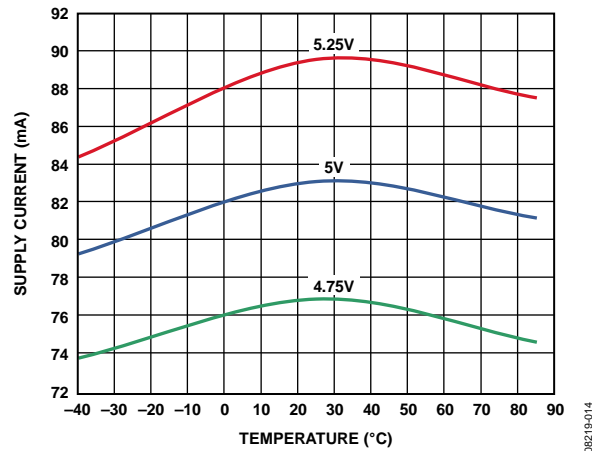

Figure 14. Supply Current vs. Temperature

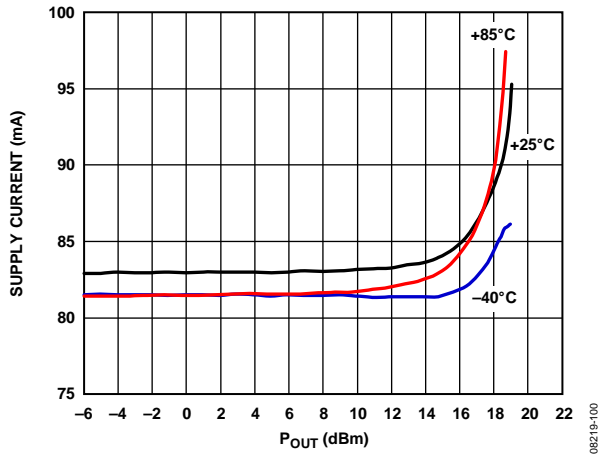

Figure 15. Supply Current vs. P<sub>OUT</sub> and Temperature V<sub>CC</sub> = 5 V

08219-100

### BASIC CONNECTIONS

The basic connections for operating the **ADL5601** are shown in Figure 16. Recommended components are listed in Table 5. The input and output should be ac-coupled with appropriately sized capacitors (the device characterization was performed with 0.1  $\mu\text{F}$  capacitors). A 5 V dc bias is supplied to the amplifier through the bias inductor connected to RFOUT (Pin 3). The bias voltage should be decoupled using a 1  $\mu\text{F}$  capacitor, a 1.2 nF capacitor, and a 68 pF capacitor.

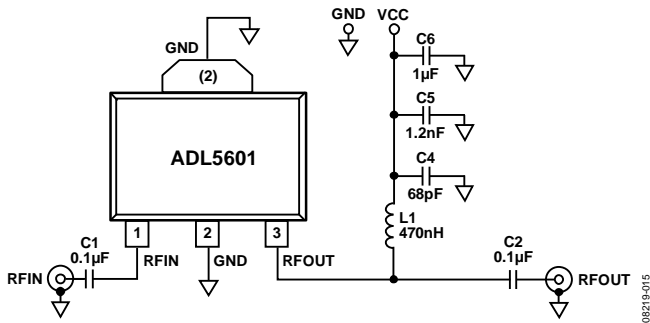

Figure 16. Basic Connections

### SOLDERING INFORMATION AND RECOMMENDED PCB LAND PATTERN

Figure 17 shows the recommended land pattern for the **ADL5601**. To minimize thermal impedance, the exposed paddle on the package underside, along with Pin 2, should be soldered to a ground plane. If multiple ground layers exist, they should be stitched together using vias. For more information on land pattern design and layout, refer to the [AN-772 Application Note, A Design and Manufacturing Guide for the Lead Frame Chip Scale Package \(LFCSP\)](#).

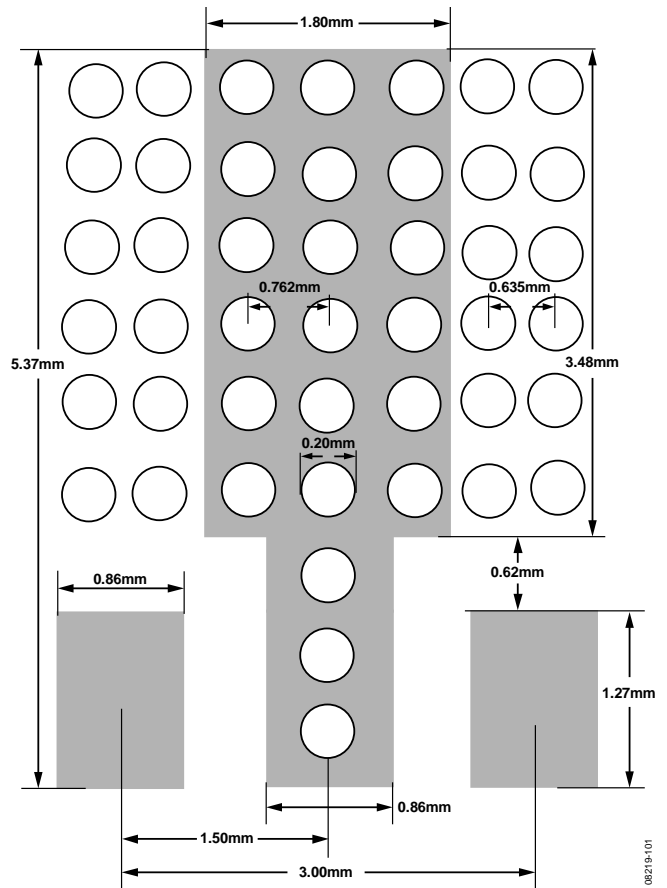

Figure 17. Recommended Land Pattern

Table 5. Recommended Components for Basic Connections

Frequency	C1	C2	L1	C4	C5	C6
50 MHz to 4000 MHz	0.1 $\mu\text{F}$	0.1 $\mu\text{F}$	470 nH (Coilcraft 0603LS-NX or equivalent)	68 pF	1.2 nF	1 $\mu\text{F}$

## W-CDMA ACPR PERFORMANCE

Figure 18 shows a plot of the adjacent channel power ratio (ACPR) vs.  $P_{OUT}$  for the ADL5601. The signal type used is a single wideband code division multiple access (W-CDMA) carrier (Test Model 1, 64) at 2140 MHz. This signal is generated by a very low ACPR source. ACPR is measured at the output by a high dynamic range spectrum analyzer that incorporates an instrument noise-correction function.

The ADL5601 achieves an ACPR of -69 dBc at -5 dBm output, at which point device noise, rather than distortion, begins to dominate the power in the adjacent channels. At an output power of +5 dBm, ACPR is still very low at -56 dBc, making the device particularly suitable for power amplifier (PA) driver applications.

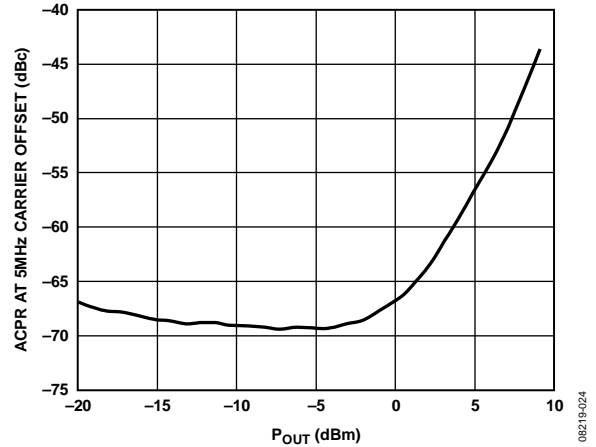

Figure 18. ACPR vs.  $P_{OUT}$ , Single W-CDMA Carrier (Test Model 1, 64) at 2140 MHz

### EVALUATION BOARD

Figure 19 shows the evaluation board layout, and Figure 20 shows the schematic for the ADL5601 evaluation board. The board is powered by a single 5 V supply.

The components used on the board are listed in Table 6. Power can be applied to the board through clip-on leads (VCC and GND).

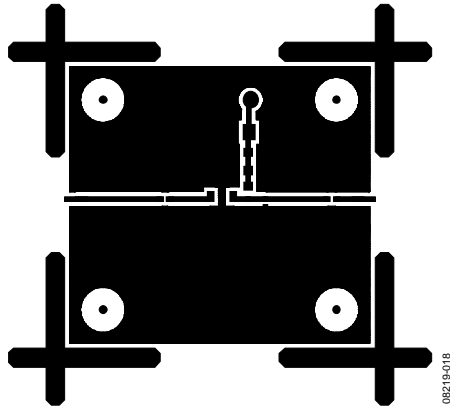

Figure 19. Evaluation Board Layout (Top)

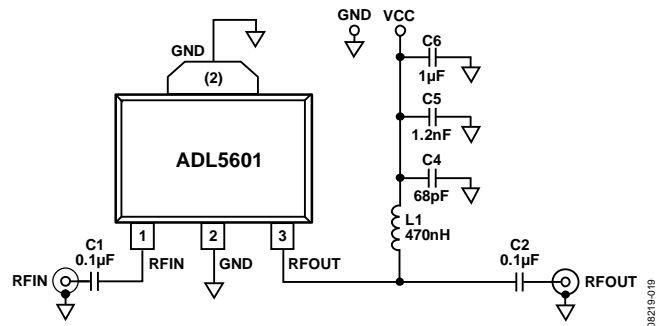

Figure 20. Evaluation Board Schematic

Table 6. Evaluation Board Configuration Options

Component	Description	Default Value
C1, C2	AC coupling capacitors	0.1 μF, 0402
L1	DC bias inductor	470 nH, 0603 (Coilcraft 0603LS-NX or equivalent)
VCC and GND	Clip-on terminals for power supply	
C4	Power supply decoupling capacitor	68 pF, 0603
C5	Power supply decoupling capacitor	1.2 nF, 0603
C6	Power supply decoupling capacitor	1 μF, 1206

# OUTLINE DIMENSIONS

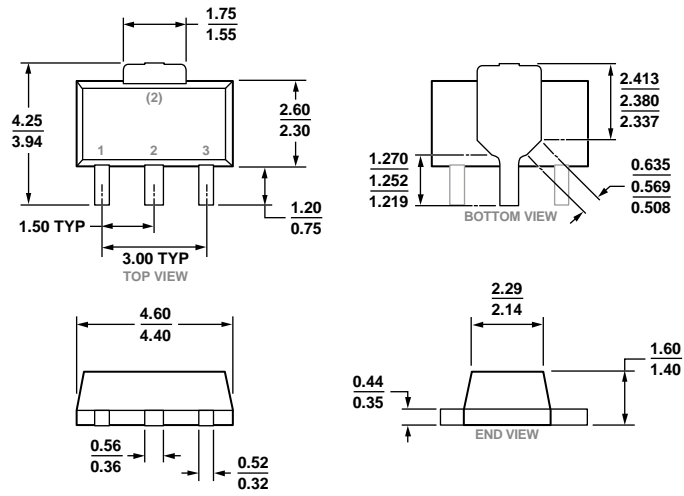

FIG-00149

09-12-2013-C

COMPLIANT TO JEDEC STANDARDS TO-243

Figure 21. 3-Lead Small Outline Transistor Package [SOT-89] (RK-3)  
Dimensions shown in millimeters

## ORDERING GUIDE

Model <sup>1</sup>	Temperature Range	Package Description	Package Option
ADL5601ARKZ-R7	-40°C to +85°C	3-Lead SOT-89, 7" Tape and Reel	RK-3
ADL5601-EVALZ		Evaluation Board	

<sup>1</sup> Z = RoHS Compliant Part.

**NOTES**