

Three phase full Bridge

with Trench MOSFETs
in DCB isolated high current package

$V_{DSS} = 100\text{ V}$
 $I_{D25} = 90\text{ A}$
 $R_{DSon\ typ.} = 7.5\text{ m}\Omega$

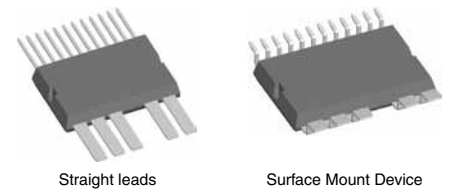
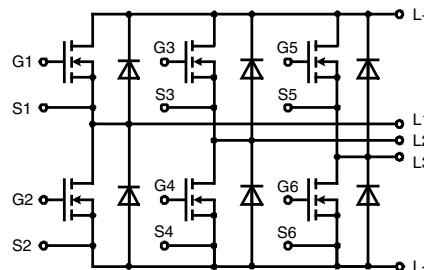

MOSFETs		Maximum Ratings	
Symbol	Conditions		
V_{DSS}	$T_J = 25^\circ\text{C to } 150^\circ\text{C}$	100	V
V_{GS}		± 20	V
I_{D25}	$T_C = 25^\circ\text{C}$	90	A
I_{D90}	$T_C = 90^\circ\text{C}$	68	A
I_{F25}	$T_C = 25^\circ\text{C (diode)}$	90	A
I_{F90}	$T_C = 90^\circ\text{C (diode)}$	68	A

Applications

- AC drives
- in automobiles
 - electric power steering
 - starter generator
 - in industrial vehicles
 - propulsion drives
 - fork lift drives
 - in battery supplied equipment

Symbol	Conditions	Characteristic Values				
		min.	typ.	max.		
$R_{DSon}^{1)}$	on chip level at $V_{GS} = 10\text{ V}; I_D = 80\text{ A}$	$T_J = 25^\circ\text{C}$ $T_J = 125^\circ\text{C}$		7.5 14	$m\Omega$ $m\Omega$	
$V_{GS(th)}$	$V_{DS} = 20\text{ V}; I_D = 250\ \mu\text{A}$	2.5		4.5	V	
I_{DSS}	$V_{DS} = V_{DSS}; V_{GS} = 0\text{ V}$		0.1	1	μA mA	
I_{GSS}	$V_{GS} = \pm 20\text{ V}; V_{DS} = 0\text{ V}$			0.2	μA	
Q_g Q_{gs} Q_{gd}	$V_{GS} = 10\text{ V}; V_{DS} = 65\text{ V}; I_D = 90\text{ A}$		90 30 30		nC nC nC	
$t_{d(on)}$ t_r $t_{d(off)}$ t_f		inductive load $V_{GS} = 10\text{ V}; V_{DS} = 48\text{ V}$ $I_D = 70\text{ A}; R_G = 33\ \Omega;$ $T_J = 125^\circ\text{C}$		130 95 290 55		ns ns ns ns
E_{on} E_{off} E_{recoff}				0.4 0.4 0.007		mJ mJ mJ
R_{thJC} R_{thJH}	with heat transfer paste (IXYS test setup)			1.3	1.0 1.6	K/W K/W

Features

- MOSFETs in trench technology:
 - low R_{DSon}
 - optimized intrinsic reverse diode
- package:
 - high level of integration
 - high current capability 300 A max.
 - aux. terminals for MOSFET control
 - terminals for soldering or welding connections
 - isolated DCB ceramic base plate with optimized heat transfer
- Space and weight savings

Package options

- 2 lead frames available
 - straight leads (SL)
 - SMD lead version (SMD)

¹⁾ $V_{DS} = I_D \cdot (R_{DS(on)} + 2R_{Pin\ to\ chip})$

Recommended replacements: MTI 85W100GC

Source-Drain Diode

Symbol	Conditions	Characteristic Values			
		min.	typ.	max.	
($T_J = 25^\circ\text{C}$, unless otherwise specified)					
V_{SD}	(diode) $I_F = 70\text{ A}$; $V_{GS} = 0\text{ V}$		0.9	1.2	V
t_{rr}	} $I_F = 70\text{ A}$; $-di_F/dt = 800\text{ A}/\mu\text{s}$; $V_R = 48\text{ V}$		55		ns
Q_{RM}			0.95		μC
I_{RM}			33		A

Component

Symbol	Conditions	Maximum Ratings	
I_{RMS}	per pin in main current paths (P+, N-, L1, L2, L3) may be additionally limited by external connections	300	A
T_J		-55...+175	$^\circ\text{C}$
T_{stg}		-55...+125	$^\circ\text{C}$
V_{ISOL}	$I_{ISOL} \leq 1\text{ mA}$, 50/60 Hz, $f = 1\text{ minute}$	1000	V~
F_c	mounting force with clip	50 - 250	N

Symbol	Conditions	Characteristic Values		
		min.	typ.	max.
$R_{pin\ to\ chip}^{1)}$			0.6	m Ω
C_p	coupling capacity between shorted pins and mounting tab in the case		160	pF
Weight			25	g

¹⁾ $V_{DS} = I_D \cdot (R_{DS(on)} + 2R_{Pin\ to\ Chip})$

PHASER

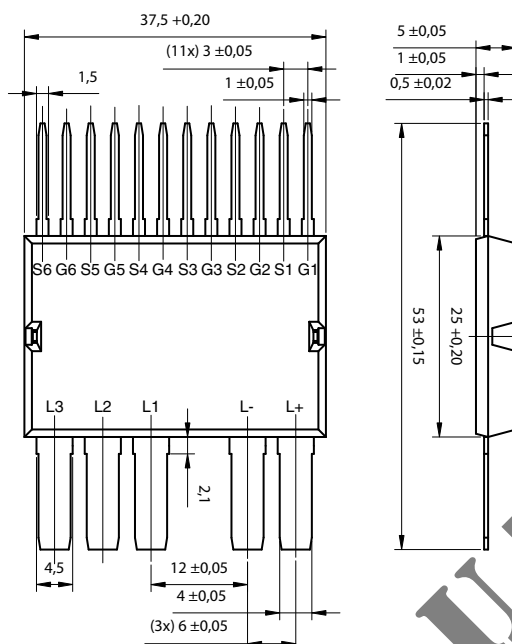
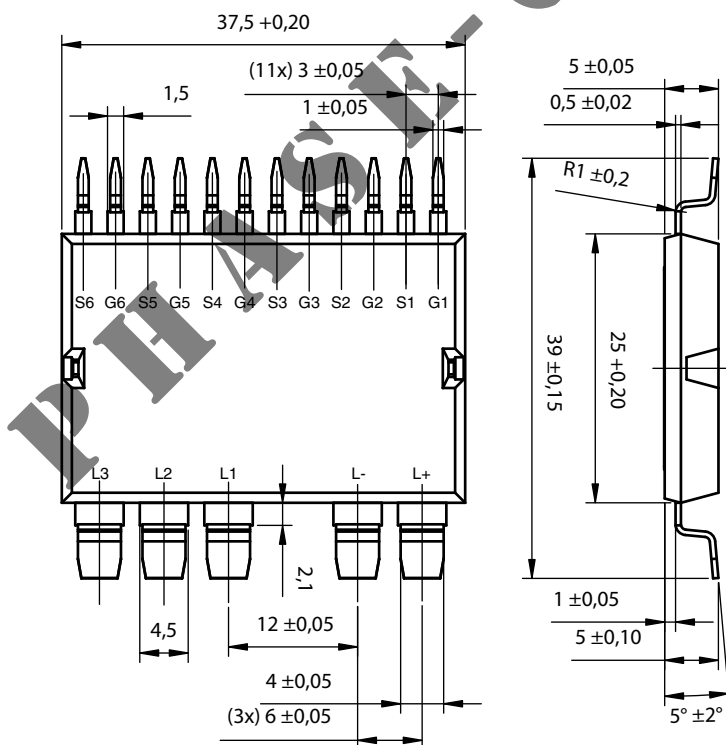
Straight Leads GWM 100-01X1-SL

Surface Mount Device GWM 100-01X1-SMD

Leads	Ordering	Part Name & Packing Unit Marking	Part Marking	Delivering Mode	Base Qty.	Ordering Code
Straight	Standard	GWM 100-01X1 - SL	GWM 100-01X1	Blister	28	505 535
SMD	Standard	GWM 100-01X1 - SMD	GWM 100-01X1	Blister	28	505 542

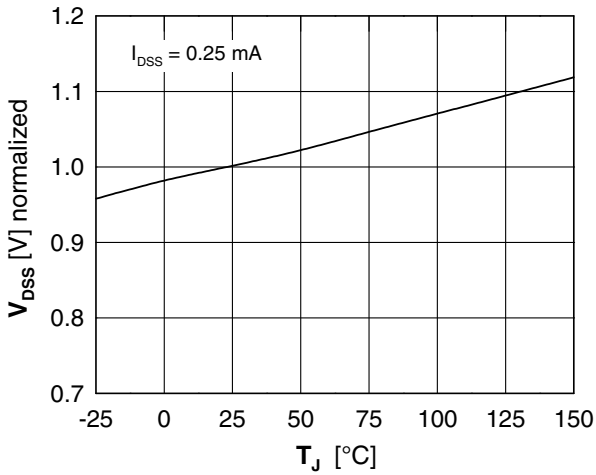

Fig. 1 Drain source breakdown voltage V_{DSS} vs. junction temperature T_J

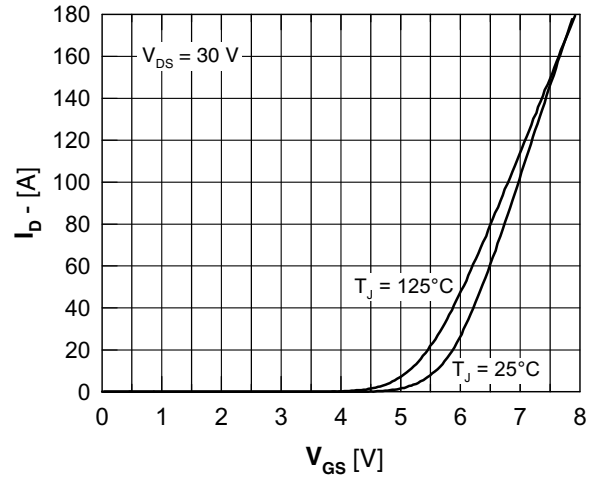

Fig. 2 Typical transfer characteristic

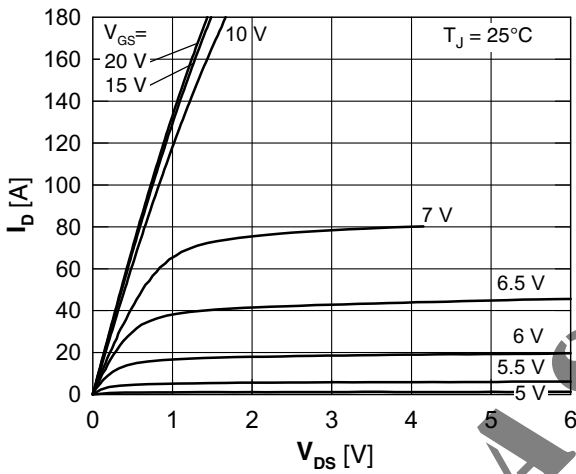

Fig. 3 Typical output characteristic

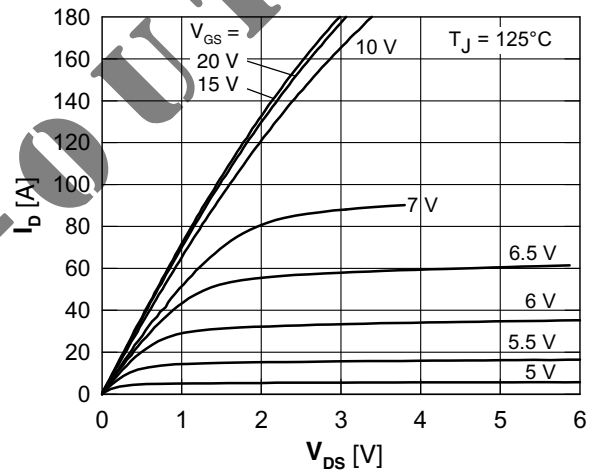

Fig. 4 Typical output characteristic

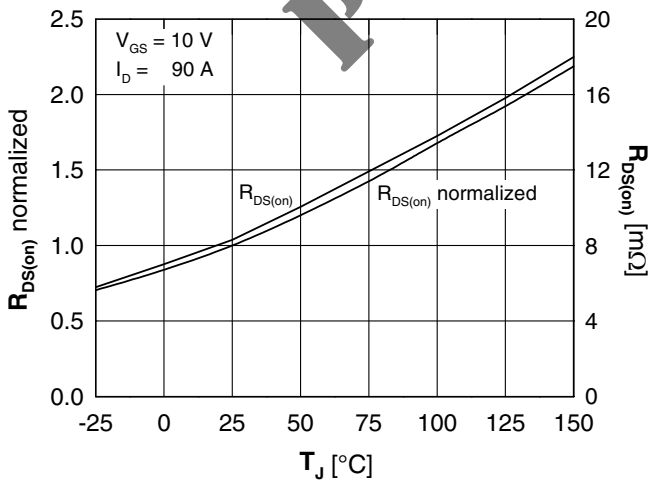

Fig. 5 Drain source on-state resistance $R_{DS(on)}$ versus junction temperature T_J

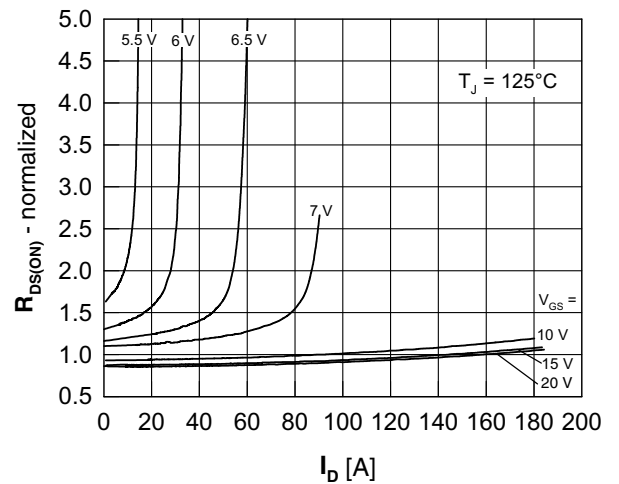

Fig. 6 Drain source on-state resistance $R_{DS(on)}$ versus I_D

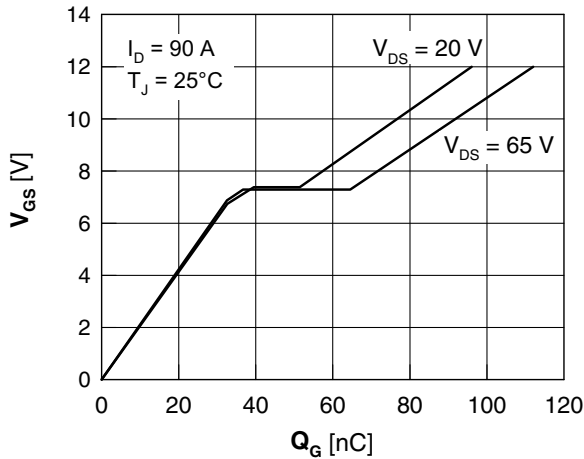

Fig. 7 Gate charge characteristic

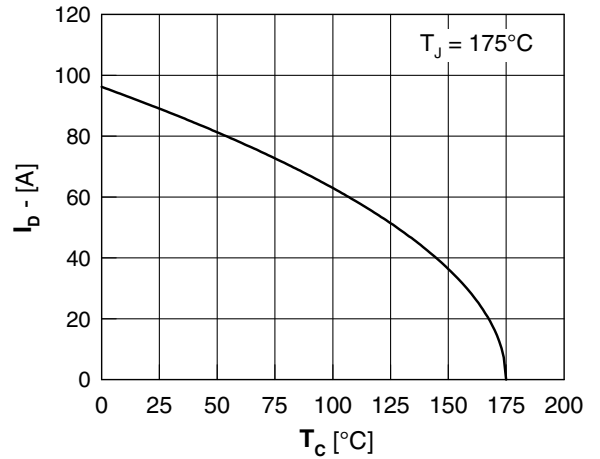

Fig. 8 Drain current I_D vs. case temperature T_c

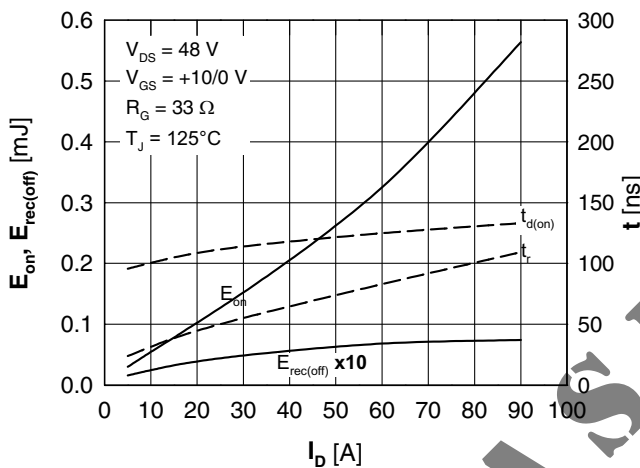

Fig. 9 Typ. turn-on energy & switching times vs. collector current, inductive switching

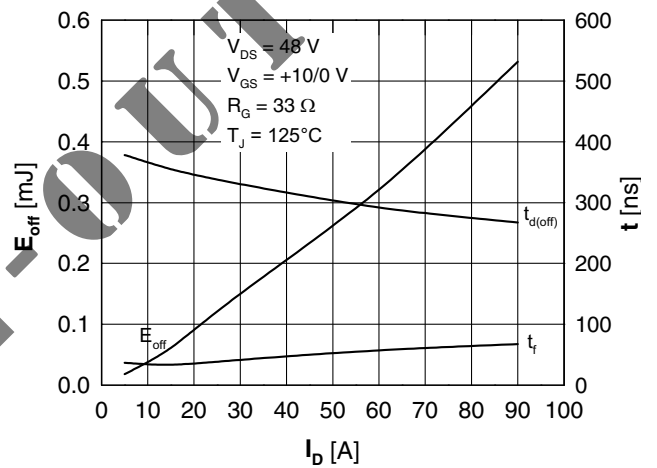

Fig. 10 Typ. turn-off energy & switching times vs. collector current, inductive switching

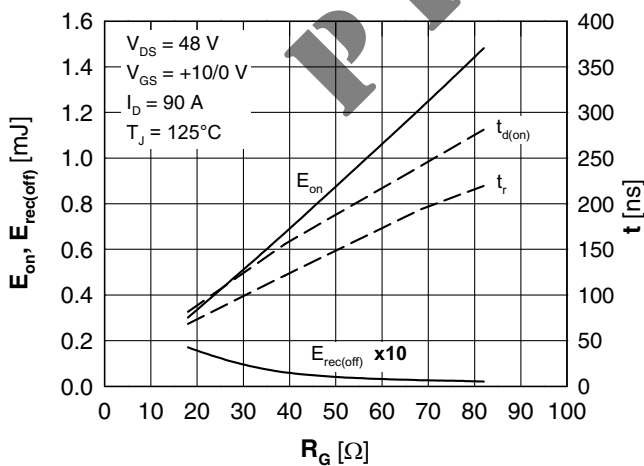

Fig. 11 Typ. turn-on energy & switching times vs. gate resistor, inductive switching

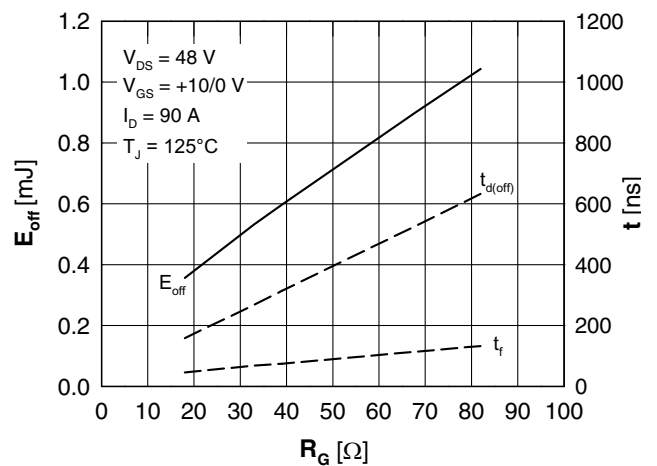

Fig. 12 Typ. turn-off energy & switching times vs. gate resistor, inductive switching

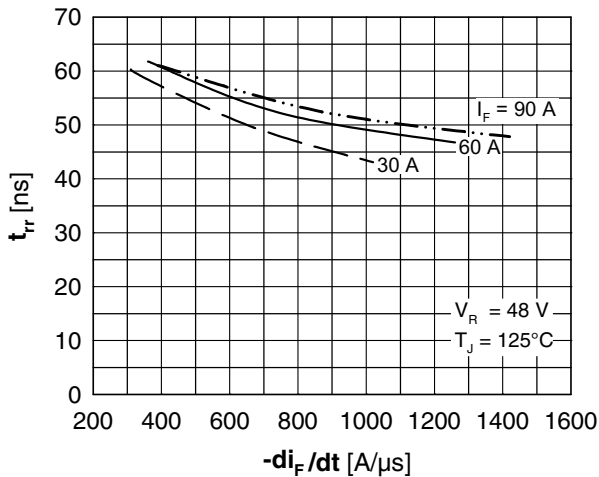

Fig. 13 Reverse recovery time t_{rr} of the body diode vs. di/dt

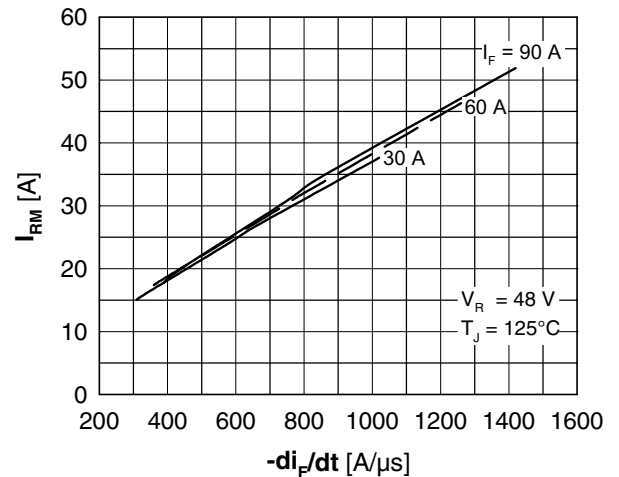

Fig. 14 Reverse recovery current I_{RM} of the body diode vs. di/dt

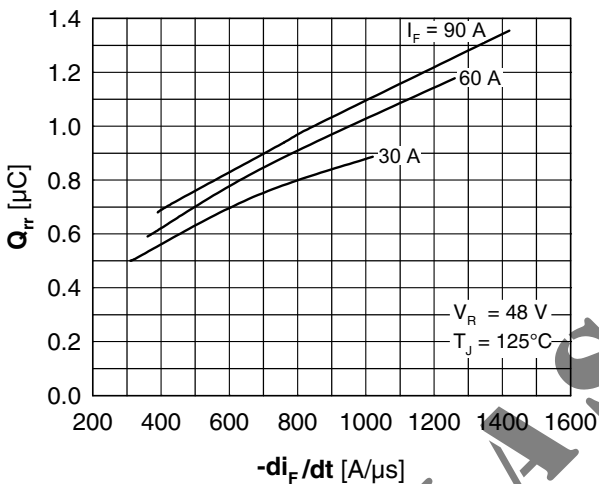

Fig. 15 Reverse recovery charge Q_{rr} of the body diode vs. di/dt

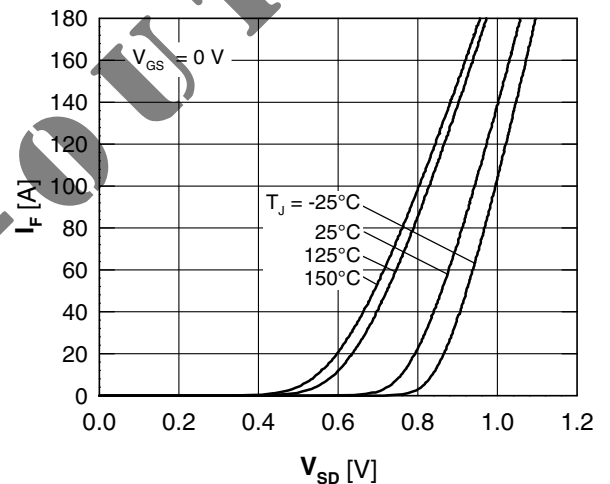

Fig. 16 Source drain diode current I_F vs. source drain voltage V_{SD} (body diode)

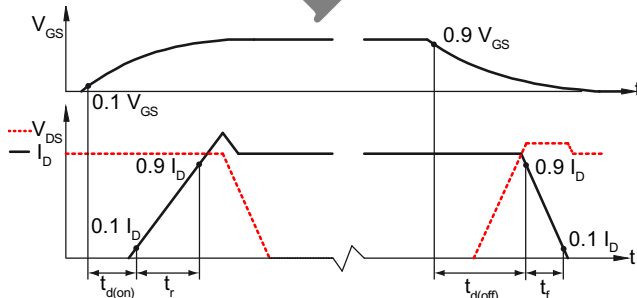

Fig. 17 Definition of switching times

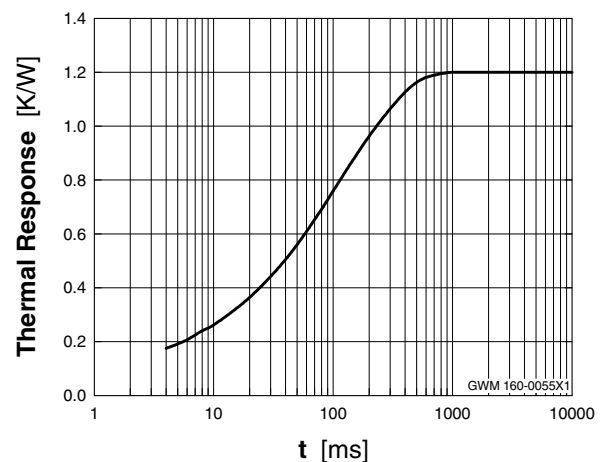

Fig. 18 Typ. thermal impedance junction to heatsink Z_{thJH} with heat transfer paste