

Features

- Constant Current mode output
- Flicker free design
- Plastic housing with class II design
- Built-in active PFC function
- No load power consumption < 0.5W (Blank-Type)
- Function options: 2 in 1 dimming (dim-to-off); Auxiliary DC output
- 3 years warranty

Applications

- LED panel lighting
- LED flood lighting
- Indoor LED lighting
- Industrial lighting

GTIN CODE

MW Search: <https://www.meanwell.com/serviceGTIN.aspx>

Description

IDLC-25 series is a 25W LED AC/DC driver featuring the constant current mode output with flicker free design. IDLC-25 operates from 90~295VAC and offers models with different rated current ranging between 350mA and 1050mA. Thanks to the efficiency up to 82%, with the fanless design, the entire series is able to operate for -20°C~+90°C case temperature under free air convection. IDLC-25 is equipped with various function options, such as dimming methodologies, so as to provide the optimal design flexibility for lighting system.

Model Encoding

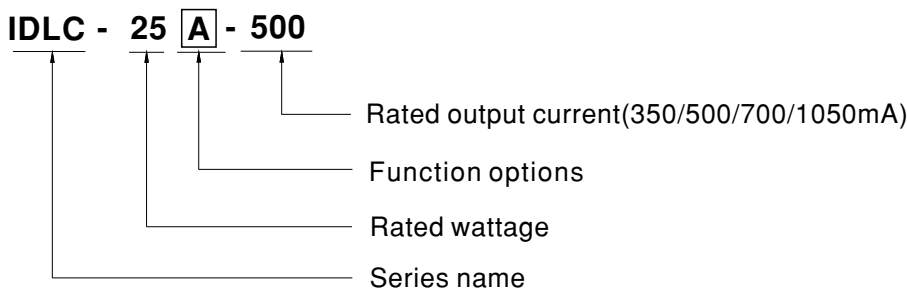

Type	Function	Note
Blank	2 in 1 dimming (0~10VDC and 10V PWM)	In Stock
A	2 in 1 dimming and Auxiliary DC output	In Stock

SPECIFICATION

MODEL		IDLC-25□-350	IDLC-25□-500	IDLC-25□-700	IDLC-25□-1050
OUTPUT	RATED CURRENT	350mA	500mA	700mA	1050mA
	RATED POWER	24.5W	25W	25.2W	25.2W
	CONSTANT CURRENT REGION <small>Note.2</small>	49 ~ 70V	35 ~ 50V	25.2 ~ 36V	16.8 ~ 24V
	OPEN CIRCUIT VOLTAGE _(max.)	100V	75V	63V	36V
	CURRENT RIPPLE	5.0% max. @rated current			
	CURRENT TOLERANCE	±7.0%			
	SETUP TIME <small>Note.4</small>	500ms / 230VAC 1200ms/115VAC			
	AUXILIARY DC OUTPUT <small>Note.5</small>	Nominal 12V(deviation 11.4~12.6)@50mA for A-Type only			
INPUT	VOLTAGE RANGE <small>Note.3</small>	90 ~ 295VAC (Please refer to "STATIC CHARACTERISTIC" section)			
	FREQUENCY RANGE	47 ~ 63Hz			
	POWER FACTOR (Typ.)	PF>0.95/115VAC, PF>0.92/230VAC, PF>0.9/277VAC@full load (Please refer to "POWER FACTOR (PF) CHARACTERISTIC" section)			
	TOTAL HARMONIC DISTORTION	THD< 20%(@load≥70%/115VAC,230VAC; @load≥75%/277VAC) (Please refer to "TOTAL HARMONIC DISTORTION" section)			
	EFFICIENCY (Typ.)	82%	81.5%	81.5%	81%
	AC CURRENT	0.4A/115VAC 0.16A/230VAC 0.13A/277VAC			
	INRUSH CURRENT (Typ.)	COLD START 30A(twidth=100μs measured at 50% Ipeak) at 230VAC; Per NEMA 410			
	MAX. No. of PSUs on 16A CIRCUIT BREAKER	32 units (circuit breaker of type B) / 32 units (circuit breaker of type C) at 230VAC			
	LEAKAGE CURRENT	<0.75mA / 277VAC			
	NO LOAD POWER CONSUMPTION	<0.5W for Blank-Type, <1.2W for A-Type			
PROTECTION	SHORT CIRCUIT	Hiccup mode, recovers automatically after fault condition is removed			
ENVIRONMENT	WORKING TEMP.	Tcase=-20 ~ +90°C (Please refer to " OUTPUT LOAD vs TEMPERATURE" section)			
	MAX. CASE TEMP.	Tcase=+90°C			
	WORKING HUMIDITY	20 ~ 90% RH non-condensing			
	STORAGE TEMP., HUMIDITY	-40 ~ +80°C, 10 ~ 95% RH			
	TEMP. COEFFICIENT	±0.03%/°C (0 ~ 45°C)			
	VIBRATION	10 ~ 500Hz, 2G 10min./1cycle, period for 60min. each along X, Y, Z axes			
SAFETY & EMC	SAFETY STANDARDS	UL8750, CSA C22.2 NO.250.13-12;BS EN/EN 61347-1 & BS EN/EN 61347-2-13 independent, BS EN/EN62384, BIS IS15885(for IDLC-25-700 only), EAC TP TC 004 approved			
	WITHSTAND VOLTAGE	I/P-O/P:3.75KVAC			
	ISOLATION RESISTANCE	I/P-O/P:100M Ohms / 500VDC / 25°C/ 70% RH			
	EMC EMISSION	Compliance to BS EN/EN55015, BS EN/EN61000-3-2 Class C (@load ≥ 70%) ; BS EN/EN61000-3-3,EAC TP TC 020			
	EMC IMMUNITY	Compliance to BS EN/EN61000-4-2,3,4,5,6,8,11; BS EN/EN61547, light industry level(surge immunity: Line-Line:1KV),EAC TP TC 020			
OTHERS	MTBF	4398.1K hrs min. Telcordia SR-332 (Bellcore) ; 1093.3K hrs min. MIL-HDBK-217F (25°C)			
	DIMENSION	110*75*22mm(L*W*H)			
	PACKING	0.196Kg; 63pcs / 13.348Kg / 0.88CUFT			
NOTE	<p>1. All parameters NOT specially mentioned are measured at 230VAC input, rated current and 25°C of ambient temperature.</p> <p>2. Please refer to "DRIVING METHODS OF LED MODULE".</p> <p>3. De-rating may be needed under low input voltages. Please refer to "STATIC CHARACTERISTIC" sections for details.</p> <p>4. Length of set up time is measured at cold first start. Turning ON/OFF the driver may lead to increase of the set up time.</p> <p>5. Aux. 12V will be damaged with short circuit; It will not be available when output voltage is not in constant current region or output no load condition.</p> <p>6. The driver is considered as a component that will be operated in combination with final equipment. Since EMC performance will be affected by the complete installation, the final equipment manufacturers must re-qualify EMC Directive on the complete installation again.</p> <p>7. The ambient temperature derating of 3.5°C/1000m with fanless models and of 5°C/1000m with fan models for operating altitude higher than 2000m(6500ft).</p> <p>8. To fulfill requirements of the latest ErP regulation for lighting fixtures, this LED power supply can only be used behind a switch without permanently connected to the mains.</p> <p>※ Product Liability Disclaimer : For detailed information, please refer to https://www.meanwell.com/serviceDisclaimer.aspx</p>				

■ **Block Diagram**

fosc : 70KHz

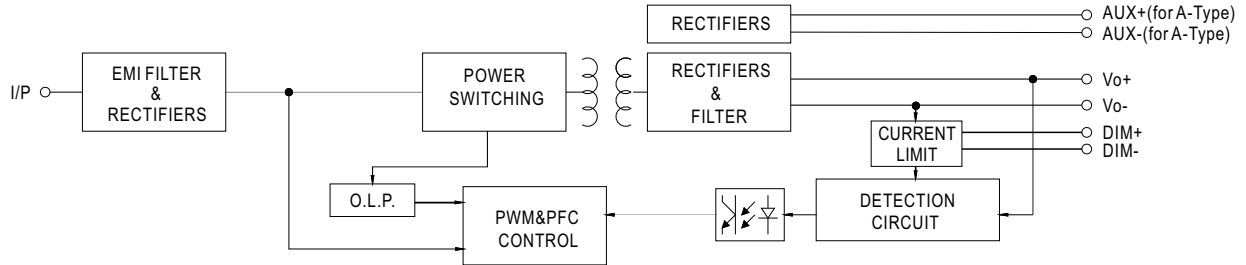

■ **DRIVING METHODS OF LED MODULE**

※ This series works in constant current mode to directly drive the LEDs.

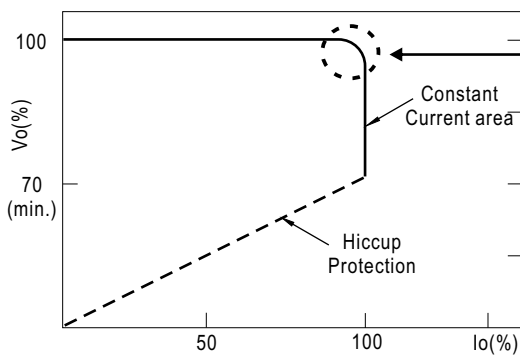

Typical output current normalized by rated current (%)

In the constant current region, the highest voltage at the output of the driver depends on the configuration of the end systems.
Should there be any compatibility issues, please contact MEAN WELL.

■ DIMMING OPERATION

※ 2 in 1 dimming function

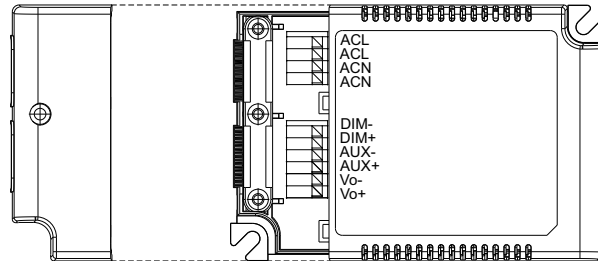

- Output constant current level can be adjusted by applying one of the two methodologies between DIM+ and DIM-: 0 ~ 10VDC, or 10V PWM signal.
- Direct connecting to LEDs is suggested. It is not suitable to be used with additional drivers.

◎ Applying additive 0 ~ 10VDC

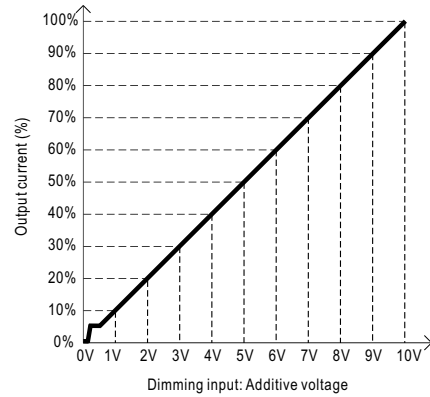
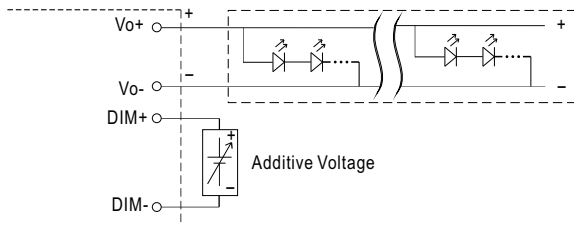

◎ Applying additive 10V PWM signal (frequency range 300Hz ~ 3KHz):

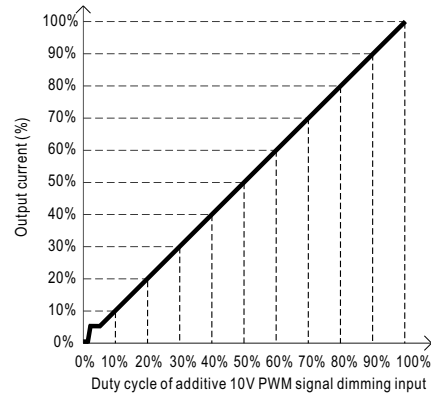
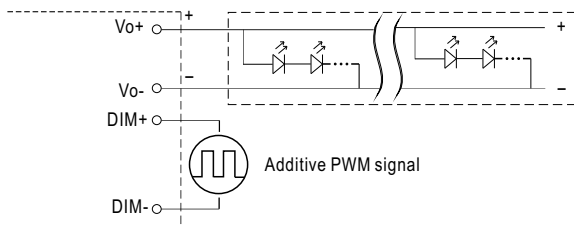

- Note : 1. Min. dimming level is about 8% and the output current is not defined when $0\% < I_{out} < 8\%$.
 2. The output current could drop down to 0% when dimming input is about 0Vdc or 10V PWM signal with 0% duty cycle.

OUTPUT LOAD vs TEMPERATURE

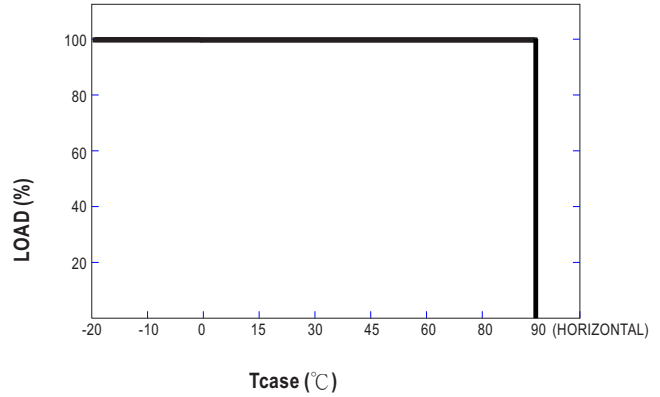
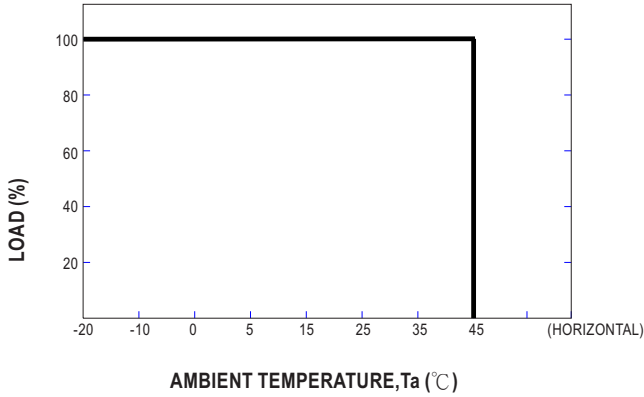

STATIC CHARACTERISTIC

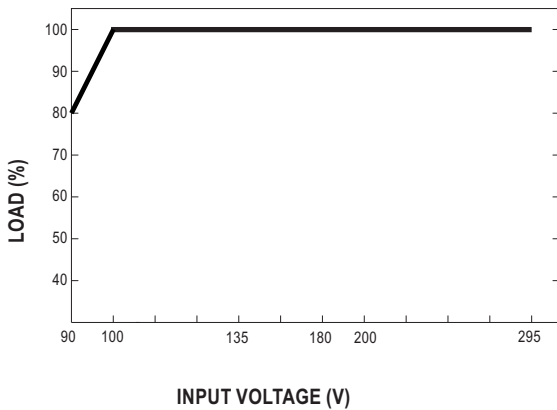

※ De-rating is needed under low input voltage.

POWER FACTOR (PF) CHARACTERISTIC

※ Tcase at 75°C

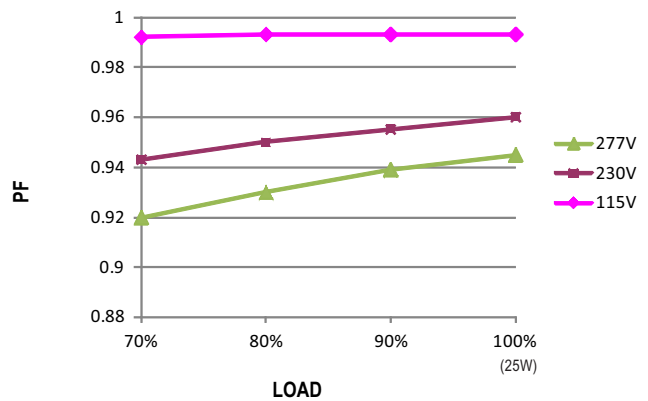

TOTAL HARMONIC DISTORTION (THD)

※ 350mA Model, Tcase at 75°C

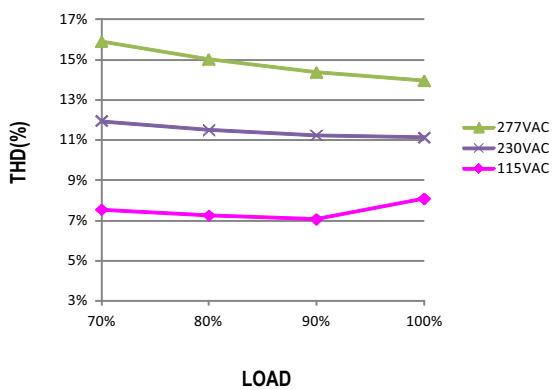

EFFICIENCY vs LOAD

IDLC-25 series possess superior working efficiency that up to 82% can be reached in field applications.

※ 350mA Model, Tcase at 75°C

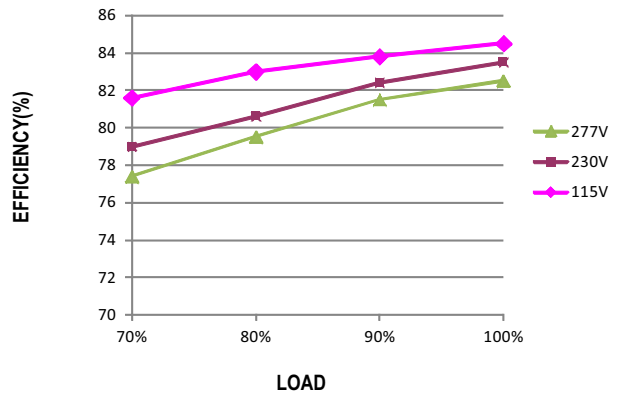

MECHANICAL SPECIFICATION

Case No. IDLC-25A Unit:mm

※ Blank-Type

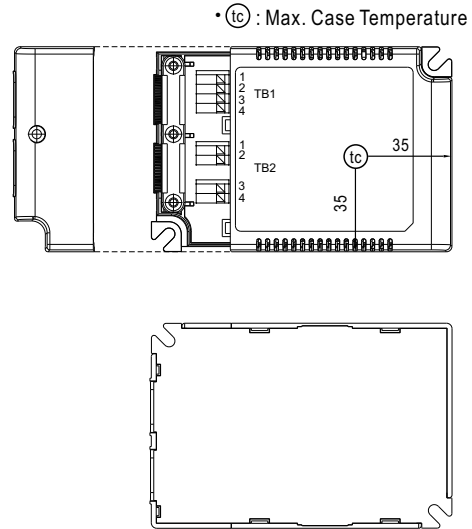
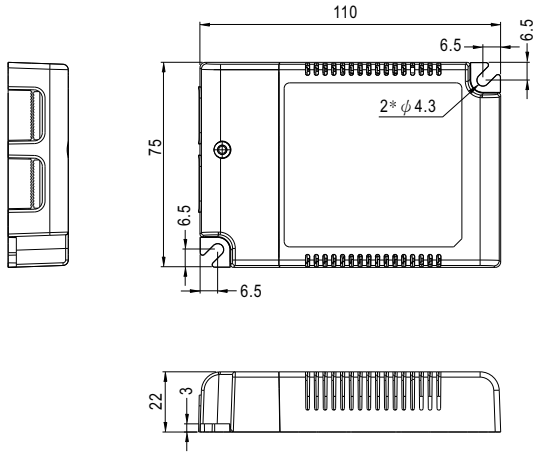

NOTE: Please use wires with a cross section of 0.75~1.5mm² for TB1 and wires with a cross section of 0.5~1.5mm² for TB2.

Terminal Pin No. Assignment(TB1)

Pin No.	Assignment
1	ACL
2	ACL
3	ACN
4	ACN

Terminal Pin No. Assignment(TB2)

Pin No.	Assignment
1	DIM-
2	DIM+
3	Vo-
4	Vo+

※ A-Type

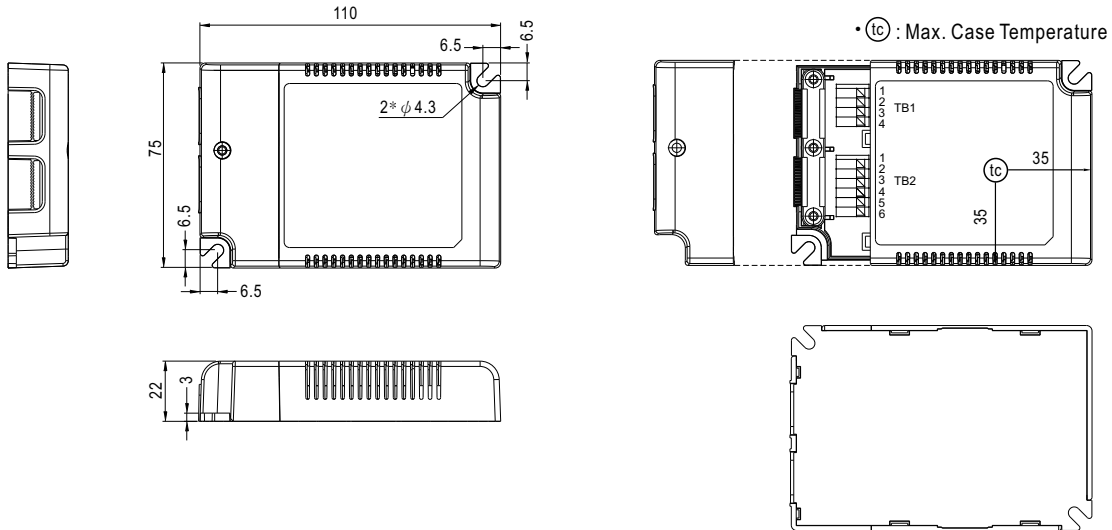

NOTE: Please use wires with a cross section of 0.75~1.5mm² for TB1 and wires with a cross section of 0.5~1.5mm² for TB2.

Terminal Pin No. Assignment(TB1)

Pin No.	Assignment
1	ACL
2	ACL
3	ACN
4	ACN

Terminal Pin No. Assignment(TB2)

Pin No.	Assignment	Pin No.	Assignment
1	DIM-	4	AUX+
2	DIM+	5	Vo-
3	AUX-	6	Vo+

■ Installation Manual

Please refer to : <http://www.meanwell.com/manual.html>